



**THE DATASHEET OF
ERJ-6GEYJ103V**



LDE, Unencapsulated Stacked Chip, Size 1206 – 6054, 50 – 1,000 VDC (Automotive Grade)

Overview

Polyethylene naphthalate (PEN) film capacitor for surface mounting, which meets the demanding Automotive Electronics Council's AEC-Q200 qualification requirements.

Applications

Typical applications include filtering, timing, bypassing, and coupling. LDE is a general purpose series designed for the highest reliability and high temperature service. Not suitable for across-the-line application (see suppressor capacitors).

Benefits

- Rated voltage: 50 – 1,000 VDC
- Rated voltage: 40 – 250 VAC
- Capacitance range: 0.001 – 4.7 μ F
- EIA Size: 1206 – 6054
- Capacitance tolerance: \pm 10%, \pm 20%, \pm 5% on request
- Climatic category: 55/125/56
- RoHS Compliant and lead-free terminations
- Operating temperature range of -55°C to +125°C
- Automotive (AEC-Q200) grades available

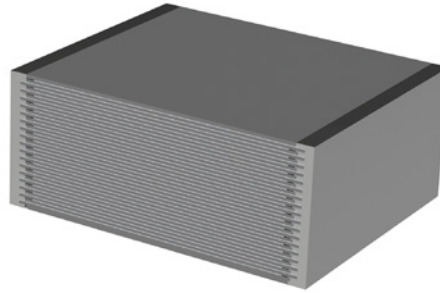

Part Number System

LDE	C	C	2560	M	A	5	N	00
Series	Rated Voltage (VDC)	Size Code	Capacitance Code (pF)	Capacitance Tolerance	Dielectric	Version	Packaging	Internal Use
Metallized PEN	C = 50 D = 63 E = 100 I = 250 M = 400 P = 630 Q = 1,000	See Dimension Table	Digits two – four indicate the first three digits of the capacitance value. First digit indicates the number of zeros to be added.	K = \pm 10% M = \pm 20% J = \pm 5% on request	A = PEN	5 = Standard 0 = Miniature	See Ordering Options Table	00 (Standard)

Dimensions – Millimeters

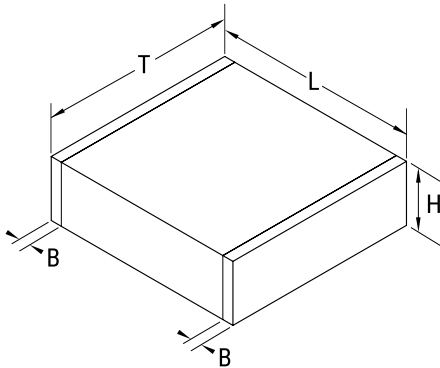

Size Code	Chip Size (EIA)	T		H (Maximum)	L		B	
		Nominal	Tolerance		Nominal	Tolerance	Nominal	Tolerance
A	1206	1.7	±0.2	See Part Number Table	3.3	+0.3/-0.1	0.4	+0.5/-0.3
B	1210	2.5	±0.3		3.3	+0.3/-0.1	0.4	+0.5/-0.3
C	1812	3.3	±0.3		4.7	+0.3/-0.2	0.4	+0.5/-0.3
D	2220	5.0	±0.4		6.0	±0.3	0.4	+0.5/-0.3
E	2824	6.1	±0.4		7.3	±0.4	0.4	+0.5/-0.3
F	4030	7.9	±0.5		10.5	±0.4	0.4	+0.5/-0.3
G	5040	10.4	±0.5		13.0	±0.4	0.4	+0.5/-0.3
H	6054	13.7	±0.5		15.5	+0.4/-0.9	0.4	+0.5/-0.3

Landing Areas and Solder Paste Suggestions

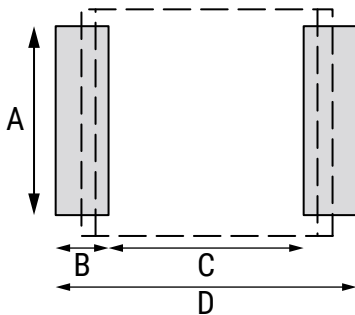

Size	Dimensions in mm				Size	Dimensions in mm			
	A	B	C	D		A	B	C	D
1206	1.5	1.1	2.3	4.5	2824	5.7	2.3	5.3	9.9
1210	2.3	1.1	2.3	4.5	4030	7.4	2.6	8.2	13.4
1812	3.0	1.7	3.1	6.5	5040	9.6	2.6	10.7	15.9
2220	4.6	2.1	3.9	8.1	6054	12.6	2.6	13.2	18.4

These landing area dimensions have the aim of taking full advantage of the new RoHS 6 terminations design.

We suggest to use a Sn/Ag/Cu solder paste (suggested thickness: 0.10 – 0.15 mm).

If a NOT Lead Free solder paste is used, a minimum peak temperature of 210°C on the component's body is suggested.

Ordering Options Table

Packaging Type	Packaging Code
Standard Packaging Options	
Tape and Reel (Standard Reel)	N

Performance Characteristics

Rated Voltage (VDC)	50	63	100	250	400	630	1,000
Rated Voltage (VAC)	40	40	63	120	160	200	250
Capacitance Range (µF)	0.001 – 4.7	0.001 – 4.7	0.001 – 4.7	0.001 – 1.5	0.015 – 0.47	0.001 – 0.27	0.001 – 0.1
Chip Size (EIA)	1206 – 6054						
Capacitance Values	E12 series						
Capacitance Tolerance	±10%, ±20%, ±5% on request						
Category Temperature Range	–55°C to +125°C						
Rated Temperature	+105°C						
Voltage Derating	V_c (category voltage) = V_R (rated voltage) up to 105°C. V_c is decreased by 1.25%/°C from +105°C to +125°C						
Climatic Category	55/125/56						
Capacitance Drift	Maximum 3% (sizes ≤ 22.20) after a 2 year storage period at a temperature of +10°C to +40°C and a relative humidity of 40% to 60% Maximum 2% (sizes > 22.20) after a 2 year storage period at a temperature of +10°C to +40°C and a relative humidity of 40% to 60%						
Reliability (Reference IEC 61709)	Failure rate ≤ 1 FIT, T = +40°C, V = 0.5 x V_R 1 FIT = 10 ⁻⁹ failures / (components * hours) Failure criteria: open or short circuit, cap. change > 10%, DF 2 times the catalog limits, IR < 0.005 x initial limit						
Insulation Resistance	Measured at +25°C ±5°C						
	Minimum Value Between Terminals						
	C ≤ 0.33 µF			1,000 MΩ			
	C > 0.33 µF			400 MΩ · µF			
Dissipation Factor	Charging time: 1 minute Charging voltage: 10 VDC for $V_R < 100$ VDC 100 VDC for $V_R ≥ 100$ VDC						
	Maximum Values at 25°C ±5°C						
Surge Voltage Test	1 kHz			0.8%			
	1.4 x V_R (2 seconds; T = 25 ± 5°C) for $V_R ≤ 630 V_{DC}$ 1.5 x V_R (2 seconds; T = 25 ± 5°C) for $V_R = 1,000 V_{DC}$						
Maximum dv/dt	100 V/us for $V_R ≤ 630$ VDC						
	300 V/us for $V_R = 1,000$ VDC						

Surface Mount Polyethylene Naphthalate (PEN) Film Capacitor
LDE, Unencapsulated Stacked Chip, Size 1206 – 6054, 50 – 1,000 VDC (Automotive Grade)

Maximum Voltage (V_{rms}) Versus Frequency (Sinusoidal Waveform/ $Th \leq 85^\circ C$)

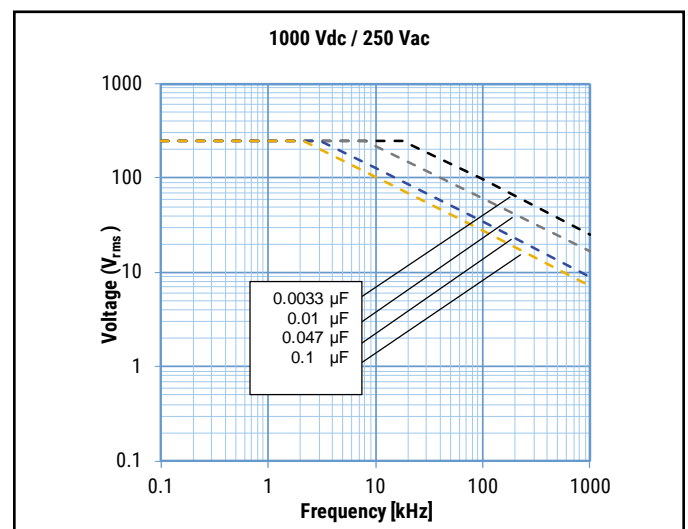
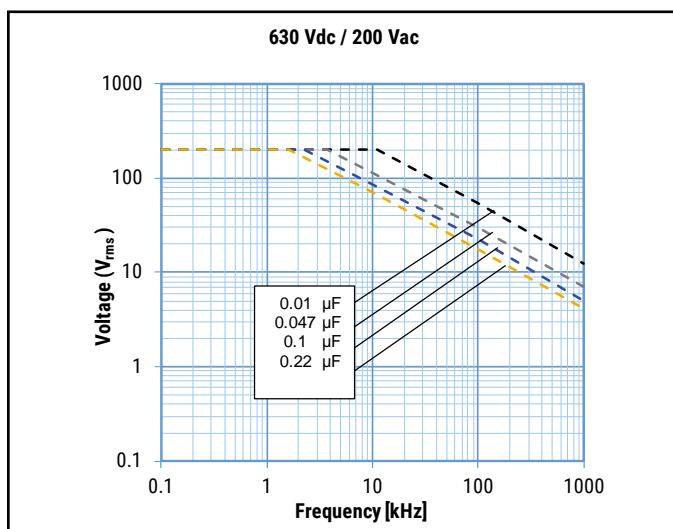
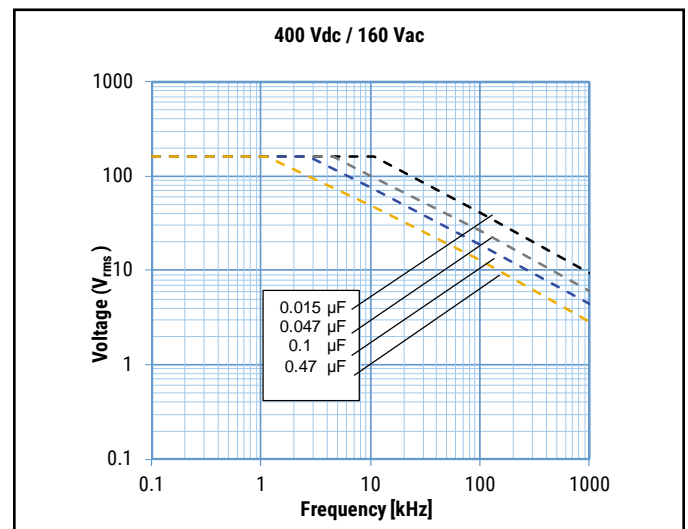
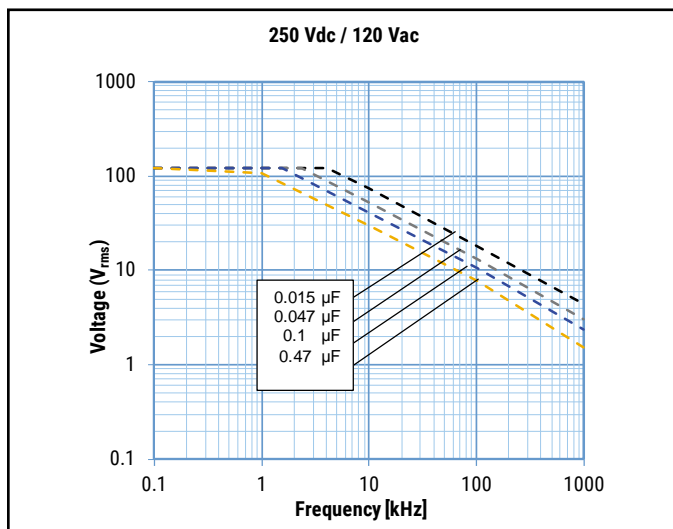
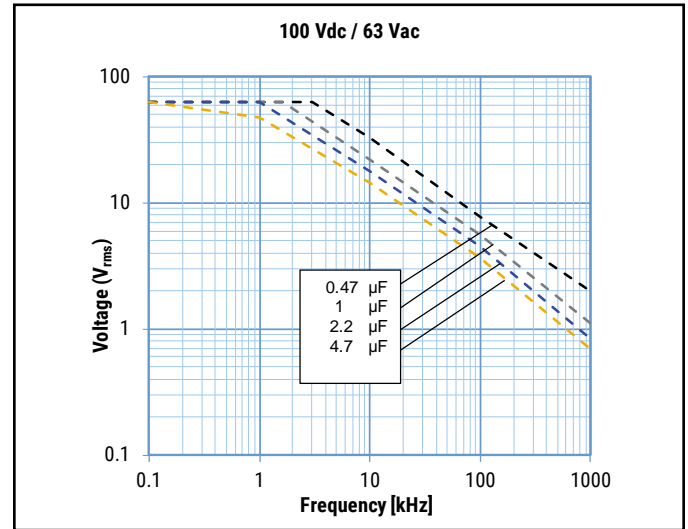
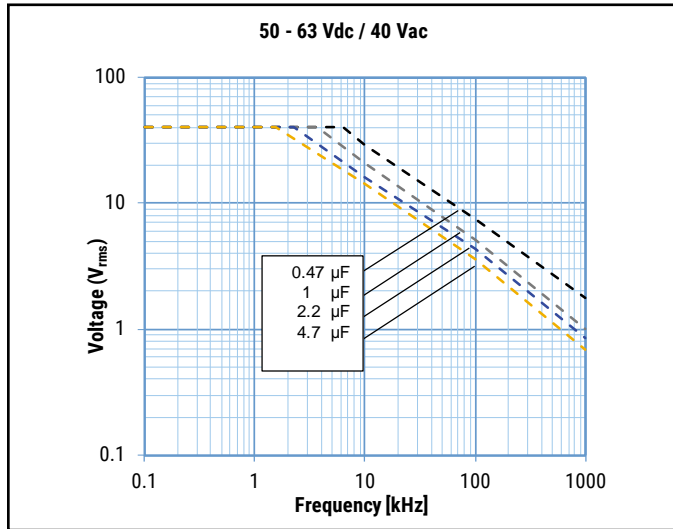

Maximum Current (I_{rms}) Versus Frequency (Sinusoidal Waveform/ $T_h \leq 85^\circ\text{C}$)

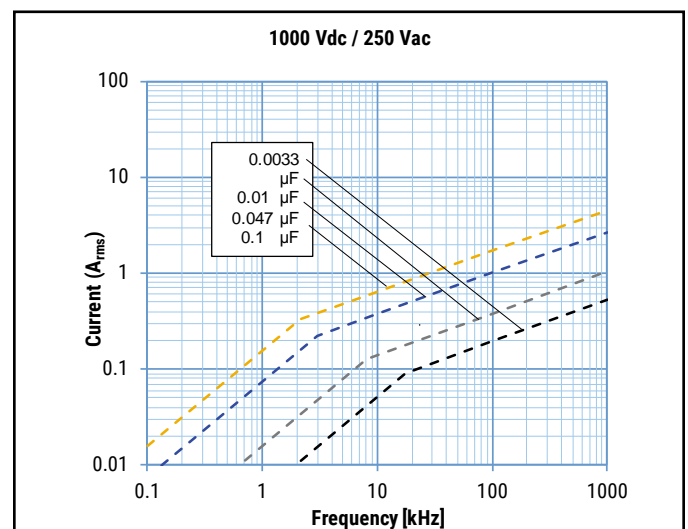
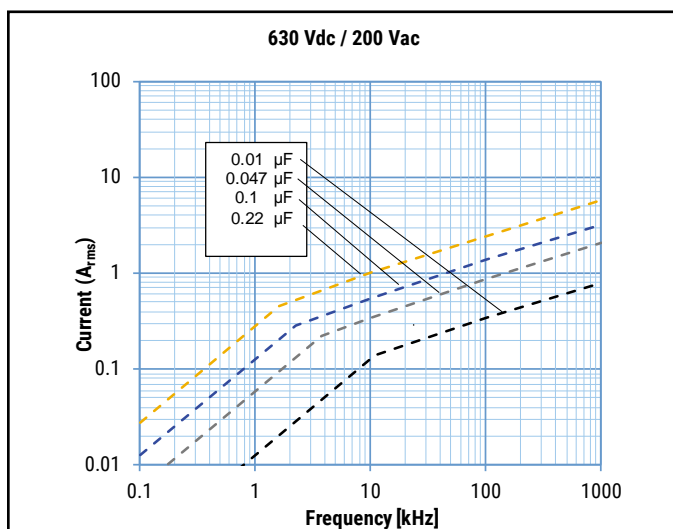
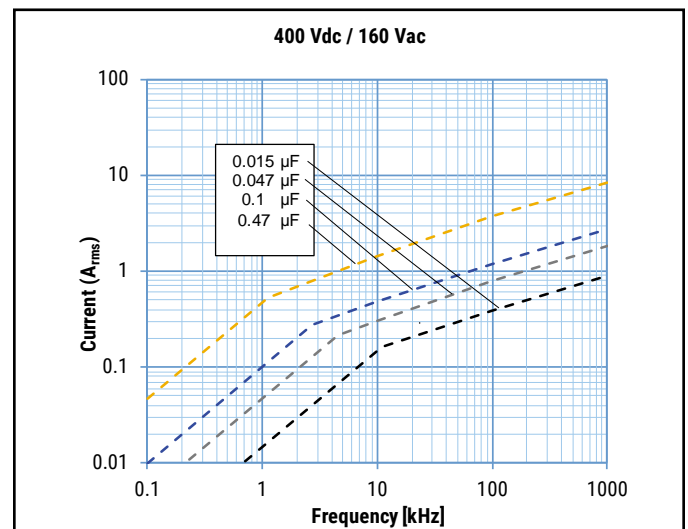
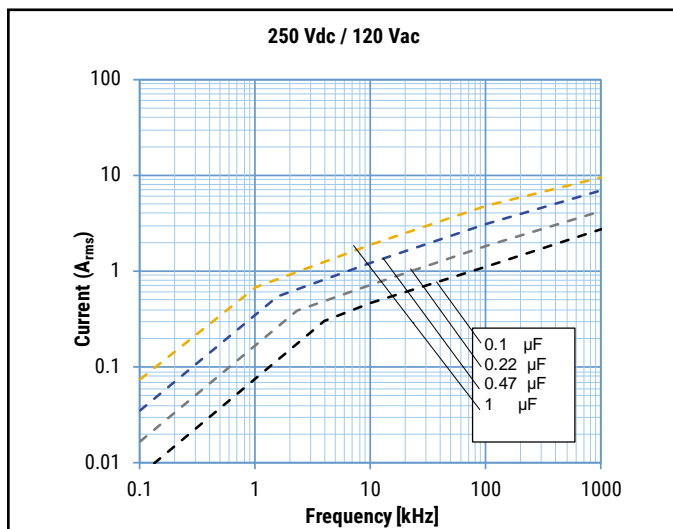
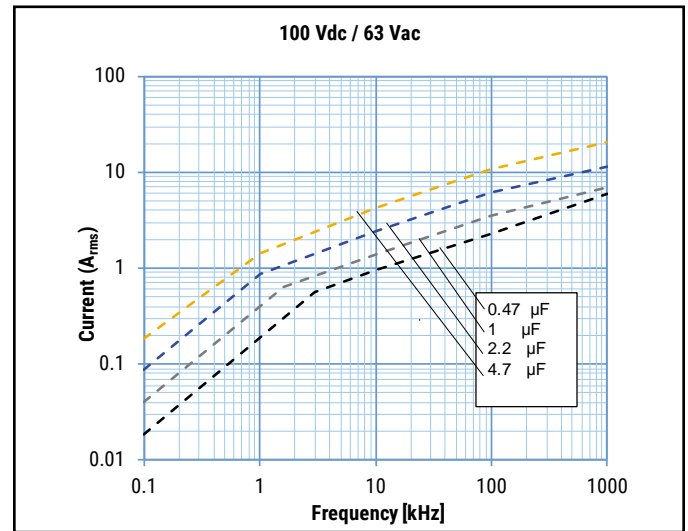
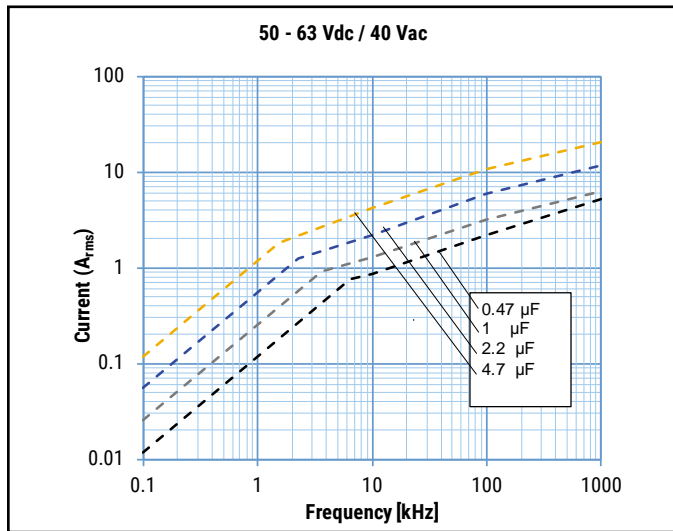

PEN Dielectric Typical Temperature Graphs

PEN Dielectric Typical Frequency Graphs

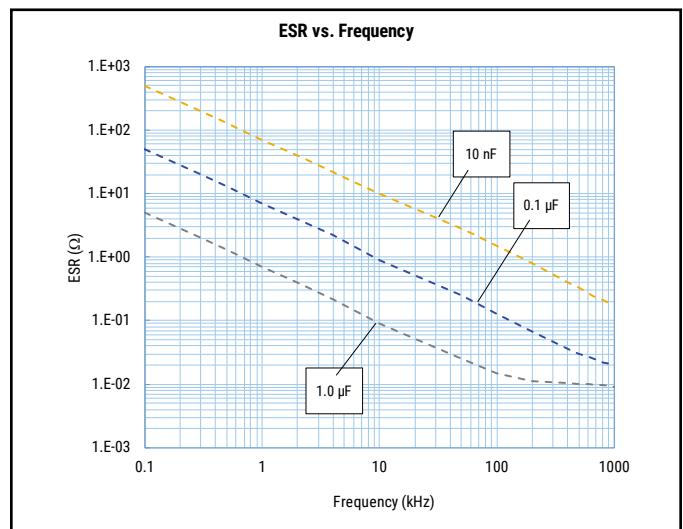
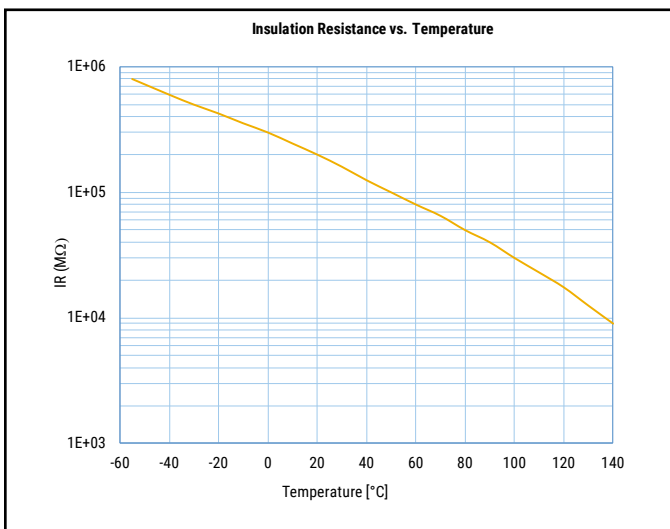
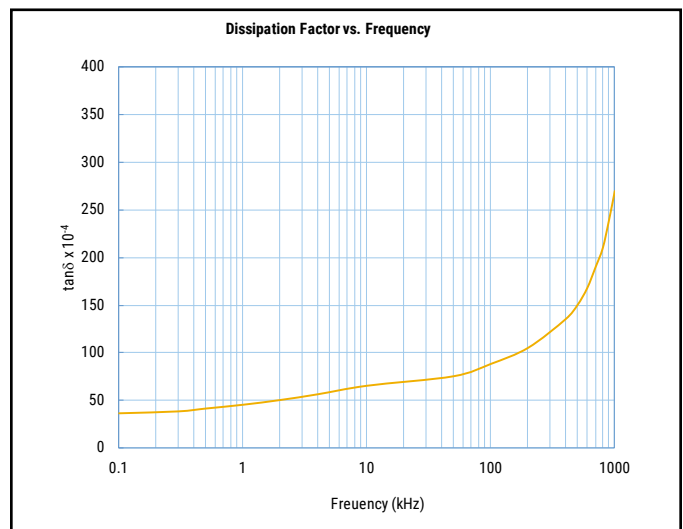
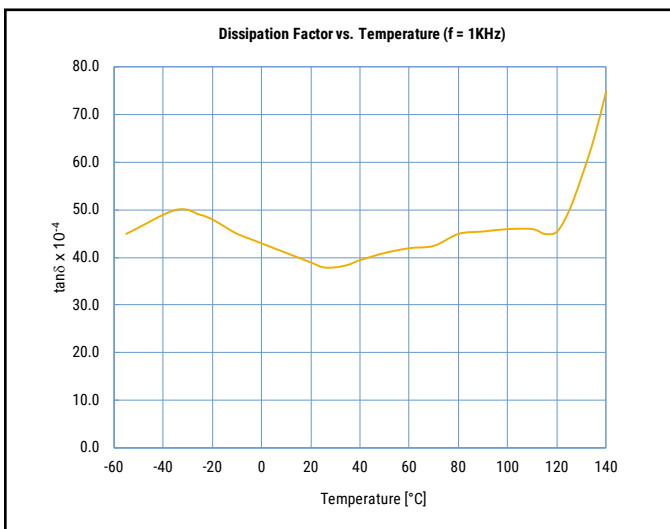
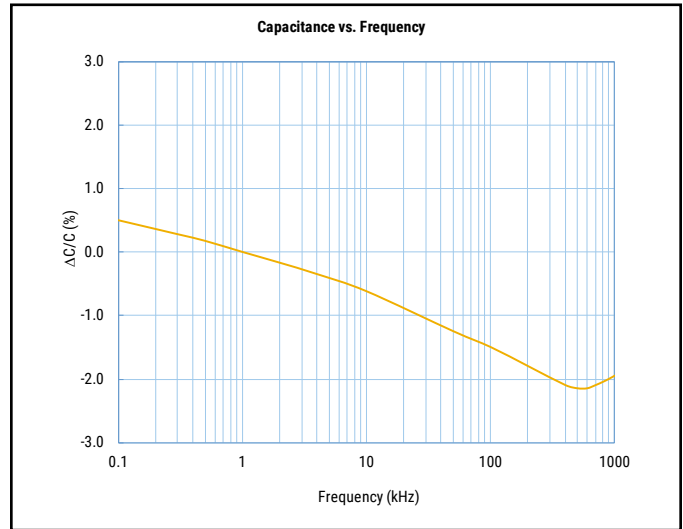
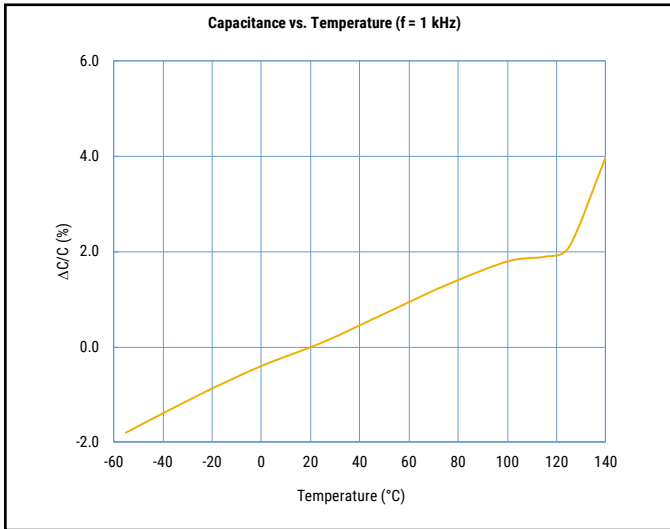

PEN and PPS Impedance vs. Frequency

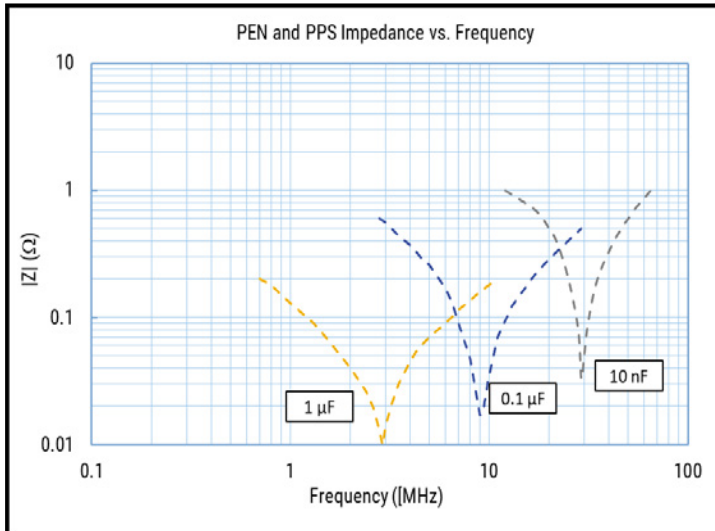

Qualification

Automotive grade products meet or exceed the requirements outlined by the Automotive Electronics Council. Details regarding test methods and conditions that are referenced in the document AEC-Q200, Stress Test Qualification for Passive Components. For additional information regarding the Automotive Electronics Council and AEC-Q200, please visit their website at www.aecouncil.com.

Environmental Compliance

All KEMET surface mount capacitors are RoHS Compliant.



Environmental Test Data

Damp Heat, Steady State	
Test Conditions	
Temperature	+40°C ±2°C
Relative Humidity (RH)	93% ±2%
Test Duration	56 days
Performance	
Capacitance Change Δ C/C	≤ 7%
DF Change (Δtgδ)	≤ 50 x 10 ⁻⁴ at 1 kHz
Insulation Resistance	≥ 50% of limit value
Endurance	
Test Conditions	
Temperature	125°C ±2°C
Test Duration	2,000 hours
Voltage Applied	1.25 x V _C
Performance	
Capacitance Change Δ C/C	≤ 5%
DF Change (Δtgδ)	≤ 50 x 10 ⁻⁴ at 1 kHz
Insulation Resistance	≥ 50% of limit value
Rapid Change of Temperature	
Test Conditions	
Temperature	1 hour at -55°C, 1 hour at +125°C
Number of Cycles	1,000
Performance	
Capacitance Change Δ C/C	≤ 5%
DF Change (Δtgδ)	≤ 50 x 10 ⁻⁴ at 1 kHz
Insulation Resistance	≥ limit value
No Mechanical Damage	

Reflow	
Test Conditions	See Solder Process
Performance	
Capacitance Change Δ C/C	≤ 3%
DF Change (Δtgδ)	≤ 50 x 10 ⁻⁴ at 1 kHz
Insulation Resistance	≥ limit value
No Mechanical Damage	
Bending	
Test Conditions	
Deflection	1 – 6 mm
Performance	
Capacitance Change Δ C/C	≤ 1%
No visible damage on the terminations (peeling) neither on the body (cracking)	

OBSOLETE

Surface Mount Polyethylene Naphthalate (PEN) Film Capacitor

LDE, Unencapsulated Stacked Chip, Size 1206 – 6054, 50 – 1,000 VDC (Automotive Grade)

Table 1 – Ratings & Part Number Reference

VDC	VAC	Capacitance Value (µF)	Size Code	Chip Size	Dimensions in mm			dV/dt (V/µs)	New KEMET Part Number	Legacy Part Number
					W	H (max)	L			
50	40	0.001	A	1206	1.7	1.1	3.3	100	DECA1100(1)A0N00	LDECA1100(1)A0N00
50	40	0.0012	A	1206	1.7	1.1	3.3	100	DECA1120(1)A0N00	LDECA1120(1)A0N00
50	40	0.0015	C	1812	3.3	1.7	4.7	100	DECC1150(1)A5N00	LDECC1150(1)A5N00
50	40	0.0015	A	1206	1.7	1.1	3.3	100	DECA1150(1)A0N00	LDECA1150(1)A0N00
50	40	0.0018	C	1812	3.3	1.7	4.7	100	DECC1180(1)A5N00	LDECC1180(1)A5N00
50	40	0.0018	A	1206	1.7	1.1	3.3	100	DECA1180(1)A0N00	LDECA1180(1)A0N00
50	40	0.0022	C	1812	3.3	1.7	4.7	100	DECC1220(1)A5N00	LDECC1220(1)A5N00
50	40	0.0022	A	1206	1.7	1.1	3.3	100	DECA1220(1)A0N00	LDECA1220(1)A0N00
50	40	0.0027	C	1812	3.3	1.8	4.7	100	DECC1270(1)A5N00	LDECC1270(1)A5N00
50	40	0.0027	A	1206	1.7	1.1	3.3	100	DECA1270(1)A0N00	LDECA1270(1)A0N00
50	40	0.0033	C	1812	3.3	1.7	4.7	100	DECC1330(1)A5N00	LDECC1330(1)A5N00
50	40	0.0033	A	1206	1.7	1.2	3.3	100	DECA1330(1)A0N00	LDECA1330(1)A0N00
50	40	0.0039	C	1812	3.3	1.7	4.7	100	DECC1390(1)A5N00	LDECC1390(1)A5N00
50	40	0.0039	A	1206	1.7	1.1	3.3	100	DECA1390(1)A0N00	LDECA1390(1)A0N00
50	40	0.0047	C	1812	3.3	1.8	4.7	100	DECC1470(1)A5N00	LDECC1470(1)A5N00
50	40	0.0047	A	1206	1.7	1.1	3.3	100	DECA1470(1)A0N00	LDECA1470(1)A0N00
50	40	0.0056	C	1812	3.3	1.7	4.7	100	DECC1560(1)A5N00	LDECC1560(1)A5N00
50	40	0.0056	A	1206	1.7	1.1	3.3	100	DECA1560(1)A0N00	LDECA1560(1)A0N00
50	40	0.0068	C	1812	3.3	1.7	4.7	100	DECC1680(1)A5N00	LDECC1680(1)A5N00
50	40	0.0068	A	1206	1.7	1.1	3.3	100	DECA1680(1)A0N00	LDECA1680(1)A0N00
50	40	0.0082	C	1812	3.3	1.8	4.7	100	DECC1820(1)A5N00	LDECC1820(1)A5N00
50	40	0.0082	A	1206	1.7	1.1	3.3	100	DECA1820(1)A0N00	LDECA1820(1)A0N00
50	40	0.01	C	1812	3.3	1.7	4.7	100	DECC2100(1)A5N00	LDECC2100(1)A5N00
50	40	0.01	A	1206	1.7	1.1	3.3	100	DECA2100(1)A0N00	LDECA2100(1)A0N00
50	40	0.012	C	1812	3.3	1.7	4.7	100	DECC2120(1)A5N00	LDECC2120(1)A5N00
50	40	0.012	A	1206	1.7	1.1	3.3	100	DECA2120(1)A0N00	LDECA2120(1)A0N00
50	40	0.015	C	1812	3.3	1.7	4.7	100	DECC2150(1)A5N00	LDECC2150(1)A5N00
50	40	0.015	A	1206	1.7	1.2	3.3	100	DECA2150(1)A0N00	LDECA2150(1)A0N00
50	40	0.018	C	1812	3.3	1.8	4.7	100	DECC2180(1)A5N00	LDECC2180(1)A5N00
50	40	0.018	A	1206	1.7	1.1	3.3	100	DECA2180(1)A0N00	LDECA2180(1)A0N00
50	40	0.022	C	1812	3.3	1.7	4.7	100	DECC2220(1)A5N00	LDECC2220(1)A5N00
50	40	0.022	A	1206	1.7	1.1	3.3	100	DECA2220(1)A0N00	LDECA2220(1)A0N00
50	40	0.027	C	1812	3.3	1.7	4.7	100	DECC2270(1)A5N00	LDECC2270(1)A5N00
50	40	0.027	A	1206	1.7	1.1	3.3	100	DECA2270(1)A0N00	LDECA2270(1)A0N00
50	40	0.033	C	1812	3.3	1.8	4.7	100	DECC2330(1)A5N00	LDECC2330(1)A5N00
50	40	0.033	B	1210	2.5	2.0	3.3	100	DECB2330(1)A0N00	LDECB2330(1)A0N00
50	40	0.033	A	1206	1.7	1.2	3.3	100	DECA2330(2)A0N00	LDECA2330(2)A0N00
50	40	0.039	C	1812	3.3	1.7	4.7	100	DECC2390(1)A5N00	LDECC2390(1)A5N00
50	40	0.039	B	1210	2.5	2.1	3.3	100	DECB2390(1)A0N00	LDECB2390(1)A0N00
50	40	0.047	C	1812	3.3	1.7	4.7	100	DECC2470(1)A5N00	LDECC2470(1)A5N00
50	40	0.047	B	1210	2.5	2.1	3.3	100	DECB2470(1)A0N00	LDECB2470(1)A0N00
50	40	0.056	C	1812	3.3	1.7	4.7	100	DECC2560(1)A5N00	LDECC2560(1)A5N00
50	40	0.056	B	1210	2.5	1.7	3.3	100	DECB2560(1)A0N00	LDECB2560(1)A0N00
50	40	0.068	C	1812	3.3	1.8	4.7	100	DECC2680(1)A5N00	LDECC2680(1)A5N00
50	40	0.068	B	1210	2.5	2.0	3.3	100	DECB2680(1)A0N00	LDECB2680(1)A0N00
50	40	0.082	C	1812	3.3	2.1	4.7	100	DECC2820(1)A5N00	LDECC2820(1)A5N00
50	40	0.082	B	1210	2.5	2.1	3.3	100	DECB2820(1)A0N00	LDECB2820(1)A0N00
50	40	0.1	C	1812	3.3	2.4	4.7	100	DECC3100(1)A5N00	LDECC3100(1)A5N00
50	40	0.1	B	1210	2.5	2.1	3.3	100	DECB3100(1)A0N00	LDECB3100(1)A0N00
50	40	0.12	C	1812	3.3	1.7	4.7	100	DECC3120(1)A5N00	LDECC3120(1)A5N00
50	40	0.15	C	1812	3.3	1.9	4.7	100	DECC3150(1)A5N00	LDECC3150(1)A5N00
50	40	0.18	C	1812	3.3	2.2	4.7	100	DECC3180(1)A5N00	LDECC3180(1)A5N00
50	40	0.22	C	1812	3.3	2.4	4.7	100	DECC3220(1)A5N00	LDECC3220(1)A5N00
50	40	0.27	D	2220	5.0	1.9	6.0	100	DECD3270(1)A5N00	LDECD3270(1)A5N00
50	40	0.33	D	2220	5.0	1.9	6.0	100	DECD3330(1)A5N00	LDECD3330(1)A5N00
50	40	0.39	D	2220	5.0	2.1	6.0	100	DECD3390(1)A5N00	LDECD3390(1)A5N00
50	40	0.47	D	2220	5.0	2.4	6.0	100	DECD3470(1)A5N00	LDECD3470(1)A5N00
50	40	0.56	D	2220	5.0	2.8	6.0	100	DECD3560(1)A5N00	LDECD3560(1)A5N00
50	40	0.68	D	2220	5.0	3.3	6.0	100	DECD3680(1)A5N00	LDECD3680(1)A5N00
VDC	VAC	Capacitance Value (µF)	Size Code	Chip Size	W (mm)	H (mm)	L (mm)	dV/dt (V/µs)	New KEMET Part Number	Legacy Part Number

(1) K = ±10%, M = ±20%, J = ±5% on request.

(2) Only K and M tolerances available.

OBSOLETE

Surface Mount Polyethylene Naphthalate (PEN) Film Capacitor

LDE, Unencapsulated Stacked Chip, Size 1206 – 6054, 50 – 1,000 VDC (Automotive Grade)

Table 1 – Ratings & Part Number Reference cont.

VDC	VAC	Capacitance Value (µF)	Size Code	Chip Size	Dimensions in mm			dV/dt (V/µs)	New KEMET Part Number	Legacy Part Number
					W	H (max)	L			
50	40	0.82	E	2824	6.1	2.9	7.3	100	DECE3820(1)A5N00	LDECE3820(1)A5N00
50	40	0.82	D	2220	5.0	3.7	6.0	100	DECD3820(1)A0N00	LDECD3820(1)A0N00
50	40	1.0	E	2824	6.1	3.1	7.3	100	DECE4100(1)A5N00	LDECE4100(1)A5N00
50	40	1.0	D	2220	5.0	4.4	6.0	100	DECD4100(1)A0N00	LDECD4100(1)A0N00
50	40	1.2	E	2824	6.1	3.6	7.3	100	DECE4120(1)A5N00	LDECE4120(1)A5N00
50	40	1.5	G	5040	10.4	3.1	13.0	100	DECG4150(1)A5N00	LDECG4150(1)A5N00
50	40	1.5	E	2824	6.1	4.3	7.3	100	DECE4150(1)A0N00	LDECE4150(1)A0N00
50	40	1.8	G	5040	10.4	3.4	13.0	100	DECG4180(1)A5N00	LDECG4180(1)A5N00
50	40	1.8	E	2824	6.1	5.1	7.3	100	DECE4180(1)A0N00	LDECE4180(1)A0N00
50	40	2.2	G	5040	10.4	4.1	13.0	100	DECG4220(1)A5N00	LDECG4220(1)A5N00
50	40	2.2	F	4030	7.9	3.3	10.5	100	DECF4220(1)A0N00	LDECF4220(1)A0N00
50	40	2.7	G	5040	10.4	4.9	13.0	100	DECG4270(1)A5N00	LDECG4270(1)A5N00
50	40	2.7	F	4030	7.9	4.0	10.5	100	DECF4270(1)A0N00	LDECF4270(1)A0N00
50	40	3.3	H	6054	13.7	3.9	15.5	100	DECH4330(1)A5N00	LDECH4330(1)A5N00
50	40	3.3	F	4030	7.9	4.7	10.5	100	DECF4330(1)A0N00	LDECF4330(1)A0N00
50	40	3.9	H	6054	13.7	4.5	15.5	100	DECH4390(1)A5N00	LDECH4390(1)A5N00
50	40	3.9	F	4030	7.9	5.5	10.5	100	DECF4390(1)A0N00	LDECF4390(1)A0N00
50	40	4.7	H	6054	13.7	5.3	15.5	100	DECH4470(1)A5N00	LDECH4470(1)A5N00
50	40	4.7	G	5040	10.4	4.1	13.0	100	DECG4470(1)A0N00	LDECG4470(1)A0N00
63	40	0.001	A	1206	1.7	1.1	3.3	100	DEDA1100(1)A0N00	LDEDA1100(1)A0N00
63	40	0.0012	A	1206	1.7	1.1	3.3	100	DEDA1120(1)A0N00	LDEDA1120(1)A0N00
63	40	0.0015	C	1812	3.3	1.7	4.7	100	DEDC1150(1)A5N00	LDEDC1150(1)A5N00
63	40	0.0015	A	1206	1.7	1.1	3.3	100	DEDA1150(1)A0N00	LDEDA1150(1)A0N00
63	40	0.0018	C	1812	3.3	1.7	4.7	100	DEDC1180(1)A5N00	LDEDC1180(1)A5N00
63	40	0.0018	A	1206	1.7	1.1	3.3	100	DEDA1180(1)A0N00	LDEDA1180(1)A0N00
63	40	0.0022	C	1812	3.3	1.7	4.7	100	DEDC1220(1)A5N00	LDEDC1220(1)A5N00
63	40	0.0022	A	1206	1.7	1.1	3.3	100	DEDA1220(1)A0N00	LDEDA1220(1)A0N00
63	40	0.0027	C	1812	3.3	1.8	4.7	100	DEDC1270(1)A5N00	LDEDC1270(1)A5N00
63	40	0.0027	A	1206	1.7	1.1	3.3	100	DEDA1270(1)A0N00	LDEDA1270(1)A0N00
63	40	0.0033	C	1812	3.3	1.7	4.7	100	DEDC1330(1)A5N00	LDEDC1330(1)A5N00
63	40	0.0033	A	1206	1.7	1.2	3.3	100	DEDA1330(1)A0N00	LDEDA1330(1)A0N00
63	40	0.0039	C	1812	3.3	1.7	4.7	100	DEDC1390(1)A5N00	LDEDC1390(1)A5N00
63	40	0.0039	A	1206	1.7	1.1	3.3	100	DEDA1390(1)A0N00	LDEDA1390(1)A0N00
63	40	0.0047	C	1812	3.3	1.8	4.7	100	DEDC1470(1)A5N00	LDEDC1470(1)A5N00
63	40	0.0047	A	1206	1.7	1.1	3.3	100	DEDA1470(1)A0N00	LDEDA1470(1)A0N00
63	40	0.0056	C	1812	3.3	1.7	4.7	100	DEDC1560(1)A5N00	LDEDC1560(1)A5N00
63	40	0.0056	A	1206	1.7	1.1	3.3	100	DEDA1560(1)A0N00	LDEDA1560(1)A0N00
63	40	0.0068	C	1812	3.3	1.7	4.7	100	DEDC1680(1)A5N00	LDEDC1680(1)A5N00
63	40	0.0068	A	1206	1.7	1.1	3.3	100	DEDA1680(1)A0N00	LDEDA1680(1)A0N00
63	40	0.0082	C	1812	3.3	1.8	4.7	100	DEDC1820(1)A5N00	LDEDC1820(1)A5N00
63	40	0.0082	A	1206	1.7	1.1	3.3	100	DEDA1820(1)A0N00	LDEDA1820(1)A0N00
63	40	0.01	C	1812	3.3	1.7	4.7	100	DEDC2100(1)A5N00	LDEDC2100(1)A5N00
63	40	0.01	A	1206	1.7	1.1	3.3	100	DEDA2100(1)A0N00	LDEDA2100(1)A0N00
63	40	0.012	C	1812	3.3	1.7	4.7	100	DEDC2120(1)A5N00	LDEDC2120(1)A5N00
63	40	0.012	A	1206	1.7	1.1	3.3	100	DEDA2120(1)A0N00	LDEDA2120(1)A0N00
63	40	0.015	C	1812	3.3	1.7	4.7	100	DEDC2150(1)A5N00	LDEDC2150(1)A5N00
63	40	0.015	A	1206	1.7	1.2	3.3	100	DEDA2150(1)A0N00	LDEDA2150(1)A0N00
63	40	0.018	C	1812	3.3	1.8	4.7	100	DEDC2180(1)A5N00	LDEDC2180(1)A5N00
63	40	0.018	A	1206	1.7	1.1	3.3	100	DEDA2180(1)A0N00	LDEDA2180(1)A0N00
63	40	0.022	C	1812	3.3	1.7	4.7	100	DEDC2220(1)A5N00	LDEDC2220(1)A5N00
63	40	0.022	A	1206	1.7	1.1	3.3	100	DEDA2220(1)A0N00	LDEDA2220(1)A0N00
63	40	0.027	C	1812	3.3	1.7	4.7	100	DEDC2270(1)A5N00	LDEDC2270(1)A5N00
63	40	0.027	A	1206	1.7	1.1	3.3	100	DEDA2270(1)A0N00	LDEDA2270(1)A0N00
63	40	0.033	C	1812	3.3	1.8	4.7	100	DEDC2330(1)A5N00	LDEDC2330(1)A5N00
63	40	0.033	B	1210	2.5	2.0	3.3	100	DEDB2330(1)A0N00	LDEDB2330(1)A0N00
63	40	0.033	A	1206	1.7	1.2	3.3	100	DEDA2330(2)A0N00	LDEDA2330(2)A0N00
63	40	0.039	C	1812	3.3	1.7	4.7	100	DEDC2390(1)A5N00	LDEDC2390(1)A5N00
63	40	0.039	B	1210	2.5	2.1	3.3	100	DEDB2390(1)A0N00	LDEDB2390(1)A0N00
63	40	0.047	C	1812	3.3	1.7	4.7	100	DEDC2470(1)A5N00	LDEDC2470(1)A5N00
VDC	VAC	Capacitance Value (µF)	Size Code	Chip Size	W (mm)	H (mm)	L (mm)	dV/dt (V/µs)	New KEMET Part Number	Legacy Part Number

(1) K = ±10%, M = ±20%, J = ±5% on request.

(2) Only K and M tolerances available.

OBSOLETE

Surface Mount Polyethylene Naphthalate (PEN) Film Capacitor

LDE, Unencapsulated Stacked Chip, Size 1206 – 6054, 50 – 1,000 VDC (Automotive Grade)

Table 1 – Ratings & Part Number Reference cont.

VDC	VAC	Capacitance Value (µF)	Size Code	Chip Size	Dimensions in mm			dV/dt (V/µs)	New KEMET Part Number	Legacy Part Number
					W	H (max)	L			
63	40	0.047	B	1210	2.5	2.1	3.3	100	DEDB2470(1)A0N00	LDEDB2470(1)A0N00
63	40	0.056	C	1812	3.3	1.7	4.7	100	DEDC2560(1)A5N00	LDEDC2560(1)A5N00
63	40	0.056	B	1210	2.5	1.7	3.3	100	DEDB2560(1)A0N00	LDEDB2560(1)A0N00
63	40	0.068	C	1812	3.3	1.8	4.7	100	DEDC2680(1)A5N00	LDEDC2680(1)A5N00
63	40	0.068	B	1210	2.5	2.0	3.3	100	DEDB2680(1)A0N00	LDEDB2680(1)A0N00
63	40	0.082	C	1812	3.3	2.1	4.7	100	DEDC2820(1)A5N00	LDEDC2820(1)A5N00
63	40	0.082	B	1210	2.5	2.1	3.3	100	DEDB2820(1)A0N00	LDEDB2820(1)A0N00
63	40	0.1	C	1812	3.3	2.4	4.7	100	DEDC3100(1)A5N00	LDEDC3100(1)A5N00
63	40	0.1	B	1210	2.5	2.1	3.3	100	DEDB3100(1)A0N00	LDEDB3100(1)A0N00
63	40	0.12	C	1812	3.3	1.7	4.7	100	DEDC3120(1)A5N00	LDEDC3120(1)A5N00
63	40	0.15	C	1812	3.3	1.9	4.7	100	DEDC3150(1)A5N00	LDEDC3150(1)A5N00
63	40	0.18	C	1812	3.3	2.2	4.7	100	DEDC3180(1)A5N00	LDEDC3180(1)A5N00
63	40	0.22	C	1812	3.3	2.4	4.7	100	DEDC3220(1)A5N00	LDEDC3220(1)A5N00
63	40	0.27	D	2220	5.0	1.9	6.0	100	DEDD3270(1)A5N00	LDEDD3270(1)A5N00
63	40	0.33	D	2220	5.0	1.9	6.0	100	DEDD3330(1)A5N00	LDEDD3330(1)A5N00
63	40	0.39	D	2220	5.0	2.1	6.0	100	DEDD3390(1)A5N00	LDEDD3390(1)A5N00
63	40	0.47	D	2220	5.0	2.4	6.0	100	DEDD3470(1)A5N00	LDEDD3470(1)A5N00
63	40	0.56	D	2220	5.0	2.8	6.0	100	DEDD3560(1)A5N00	LDEDD3560(1)A5N00
63	40	0.68	D	2220	5.0	3.3	6.0	100	DEDD3680(1)A5N00	LDEDD3680(1)A5N00
63	40	0.82	E	2824	6.1	2.9	7.3	100	DEDE3820(1)A5N00	LDEDE3820(1)A5N00
63	40	0.82	D	2220	5.0	3.7	6.0	100	DEDD3820(1)A0N00	LDEDD3820(1)A0N00
63	40	1.0	E	2824	6.1	3.1	7.3	100	DEDE4100(1)A5N00	LDEDE4100(1)A5N00
63	40	1.0	D	2220	5.0	4.4	6.0	100	DEDD4100(1)A0N00	LDEDD4100(1)A0N00
63	40	1.2	E	2824	6.1	3.6	7.3	100	DEDE4120(1)A5N00	LDEDE4120(1)A5N00
63	40	1.5	G	5040	10.4	3.1	13.0	100	DEDG4150(1)A5N00	LDEDG4150(1)A5N00
63	40	1.5	E	2824	6.1	4.3	7.3	100	DEDE4150(1)A0N00	LDEDE4150(1)A0N00
63	40	1.8	G	5040	10.4	3.4	13.0	100	DEDG4180(1)A5N00	LDEDG4180(1)A5N00
63	40	1.8	E	2824	6.1	5.1	7.3	100	DEDE4180(1)A0N00	LDEDE4180(1)A0N00
63	40	2.2	G	5040	10.4	4.1	13.0	100	DEDG4220(1)A5N00	LDEDG4220(1)A5N00
63	40	2.2	F	4030	7.9	3.3	10.5	100	DEDF4220(1)A0N00	LDEDF4220(1)A0N00
63	40	2.7	G	5040	10.4	4.9	13.0	100	DEDG4270(1)A5N00	LDEDG4270(1)A5N00
63	40	2.7	F	4030	7.9	4.0	10.5	100	DEDF4270(1)A0N00	LDEDF4270(1)A0N00
63	40	3.3	H	6054	13.7	3.9	15.5	100	DEDH4330(1)A5N00	LDEDH4330(1)A5N00
63	40	3.3	F	4030	7.9	4.7	10.5	100	DEDF4330(1)A0N00	LDEDF4330(1)A0N00
63	40	3.9	H	6054	13.7	4.5	15.5	100	DEDH4390(1)A5N00	LDEDH4390(1)A5N00
63	40	3.9	F	4030	7.9	5.5	10.5	100	DEDF4390(1)A0N00	LDEDF4390(1)A0N00
63	40	4.7	H	6054	13.7	5.3	15.5	100	DEDH4470(1)A5N00	LDEDH4470(1)A5N00
63	40	4.7	G	5040	10.4	4.1	13.0	100	DEDG4470(1)A0N00	LDEDG4470(1)A0N00
100	63	0.001	A	1206	1.7	1.1	3.3	100	DEEA1100(1)A0N00	LDEEA1100(1)A0N00
100	63	0.0012	A	1206	1.7	1.1	3.3	100	DEEA1120(1)A0N00	LDEEA1120(1)A0N00
100	63	0.0015	C	1812	3.3	1.7	4.7	100	DEEC1150(1)A5N00	LDEEC1150(1)A5N00
100	63	0.0015	A	1206	1.7	1.1	3.3	100	DEEA1150(1)A0N00	LDEEA1150(1)A0N00
100	63	0.0018	C	1812	3.3	1.7	4.7	100	DEEC1180(1)A5N00	LDEEC1180(1)A5N00
100	63	0.0018	A	1206	1.7	1.1	3.3	100	DEEA1180(1)A0N00	LDEEA1180(1)A0N00
100	63	0.0022	C	1812	3.3	1.7	4.7	100	DEEC1220(1)A5N00	LDEEC1220(1)A5N00
100	63	0.0022	A	1206	1.7	1.1	3.3	100	DEEA1220(1)A0N00	LDEEA1220(1)A0N00
100	63	0.0027	C	1812	3.3	1.8	4.7	100	DEEC1270(1)A5N00	LDEEC1270(1)A5N00
100	63	0.0027	A	1206	1.7	1.1	3.3	100	DEEA1270(1)A0N00	LDEEA1270(1)A0N00
100	63	0.0033	C	1812	3.3	1.7	4.7	100	DEEC1330(1)A5N00	LDEEC1330(1)A5N00
100	63	0.0033	A	1206	1.7	1.2	3.3	100	DEEA1330(1)A0N00	LDEEA1330(1)A0N00
100	63	0.0039	C	1812	3.3	1.7	4.7	100	DEEC1390(1)A5N00	LDEEC1390(1)A5N00
100	63	0.0039	A	1206	1.7	1.1	3.3	100	DEEA1390(1)A0N00	LDEEA1390(1)A0N00
100	63	0.0047	C	1812	3.3	1.8	4.7	100	DEEC1470(1)A5N00	LDEEC1470(1)A5N00
100	63	0.0047	A	1206	1.7	1.1	3.3	100	DEEA1470(1)A0N00	LDEEA1470(1)A0N00
100	63	0.0056	C	1812	3.3	1.7	4.7	100	DEEC1560(1)A5N00	LDEEC1560(1)A5N00
100	63	0.0056	A	1206	1.7	1.1	3.3	100	DEEA1560(1)A0N00	LDEEA1560(1)A0N00
100	63	0.0068	C	1812	3.3	1.7	4.7	100	DEEC1680(1)A5N00	LDEEC1680(1)A5N00
100	63	0.0068	A	1206	1.7	1.1	3.3	100	DEEA1680(1)A0N00	LDEEA1680(1)A0N00
100	63	0.0082	C	1812	3.3	1.8	4.7	100	DEEC1820(1)A5N00	LDEEC1820(1)A5N00
VDC	VAC	Capacitance Value (µF)	Size Code	Chip Size	W (mm)	H (mm)	L (mm)	dV/dt (V/µs)	New KEMET Part Number	Legacy Part Number

(1) K = ±10%, M = ±20%, J = ±5% on request.

(2) Only K and M tolerances available.

OBSOLETE

Surface Mount Polyethylene Naphthalate (PEN) Film Capacitor

LDE, Unencapsulated Stacked Chip, Size 1206 – 6054, 50 – 1,000 VDC (Automotive Grade)

Table 1 – Ratings & Part Number Reference cont.

VDC	VAC	Capacitance Value (µF)	Size Code	Chip Size	Dimensions in mm			dV/dt (V/µs)	New KEMET Part Number	Legacy Part Number
					W	H (max)	L			
100	63	0.0082	A	1206	1.7	1.1	3.3	100	DEEA1820(1)A0N00	LDEEA1820(1)A0N00
100	63	0.01	C	1812	3.3	1.7	4.7	100	DEEC2100(1)A5N00	LDEEC2100(1)A5N00
100	63	0.01	A	1206	1.7	1.1	3.3	100	DEEA2100(1)A0N00	LDEEA2100(1)A0N00
100	63	0.012	C	1812	3.3	1.7	4.7	100	DEEC2120(1)A5N00	LDEEC2120(1)A5N00
100	63	0.012	A	1206	1.7	1.1	3.3	100	DEEA2120(1)A0N00	LDEEA2120(1)A0N00
100	63	0.015	C	1812	3.3	1.7	4.7	100	DEEC2150(1)A5N00	LDEEC2150(1)A5N00
100	63	0.015	A	1206	1.7	1.2	3.3	100	DEEA2150(1)A0N00	LDEEA2150(1)A0N00
100	63	0.018	C	1812	3.3	1.8	4.7	100	DEEC2180(1)A5N00	LDEEC2180(1)A5N00
100	63	0.018	B	1210	2.5	1.5	3.3	100	DEEB2180(1)A0N00	LDEEB2180(1)A0N00
100	63	0.022	C	1812	3.3	1.7	4.7	100	DEEC2220(1)A5N00	LDEEC2220(1)A5N00
100	63	0.022	B	1210	2.5	1.5	3.3	100	DEEB2220(1)A0N00	LDEEB2220(1)A0N00
100	63	0.027	C	1812	3.3	1.7	4.7	100	DEEC2270(1)A5N00	LDEEC2270(1)A5N00
100	63	0.027	B	1210	2.5	1.7	3.3	100	DEEB2270(1)A0N00	LDEEB2270(1)A0N00
100	63	0.033	C	1812	3.3	1.8	4.7	100	DEEC2330(1)A5N00	LDEEC2330(1)A5N00
100	63	0.033	B	1210	2.5	2.0	3.3	100	DEEB2330(1)A0N00	LDEEB2330(1)A0N00
100	63	0.039	C	1812	3.3	1.7	4.7	100	DEEC2390(1)A5N00	LDEEC2390(1)A5N00
100	63	0.039	B	1210	2.5	2.1	3.3	100	DEEB2390(1)A0N00	LDEEB2390(1)A0N00
100	63	0.047	C	1812	3.3	1.7	4.7	100	DEEC2470(1)A5N00	LDEEC2470(1)A5N00
100	63	0.047	B	1210	2.5	2.1	3.3	100	DEEB2470(1)A0N00	LDEEB2470(1)A0N00
100	63	0.056	C	1812	3.3	1.7	4.7	100	DEEC2560(1)A5N00	LDEEC2560(1)A5N00
100	63	0.068	C	1812	3.3	1.8	4.7	100	DEEC2680(1)A5N00	LDEEC2680(1)A5N00
100	63	0.082	C	1812	3.3	2.1	4.7	100	DEEC2820(1)A5N00	LDEEC2820(1)A5N00
100	63	0.1	C	1812	3.3	2.4	4.7	100	DEEC3100(1)A5N00	LDEEC3100(1)A5N00
100	63	0.12	D	2220	5.0	1.9	6.0	100	DEED3120(1)A5N00	LDEED3120(1)A5N00
100	63	0.15	D	2220	5.0	1.9	6.0	100	DEED3150(1)A5N00	LDEED3150(1)A5N00
100	63	0.18	D	2220	5.0	2.0	6.0	100	DEED3180(1)A5N00	LDEED3180(1)A5N00
100	63	0.22	D	2220	5.0	2.4	6.0	100	DEED3220(1)A5N00	LDEED3220(1)A5N00
100	63	0.27	D	2220	5.0	2.8	6.0	100	DEED3270(1)A5N00	LDEED3270(1)A5N00
100	63	0.33	D	2220	5.0	3.3	6.0	100	DEED3330(1)A5N00	LDEED3330(1)A5N00
100	63	0.39	E	2824	6.1	2.6	7.3	100	DEEE3390(1)A5N00	LDEEE3390(1)A5N00
100	63	0.39	D	2220	5.0	3.7	6.0	100	DEED3390(1)A0N00	LDEED3390(1)A0N00
100	63	0.47	E	2824	6.1	3.0	7.3	100	DEEE3470(1)A5N00	LDEEE3470(1)A5N00
100	63	0.47	D	2220	5.0	4.4	6.0	100	DEED3470(1)A0N00	LDEED3470(1)A0N00
100	63	0.56	E	2824	6.1	3.5	7.3	100	DEEE3560(1)A5N00	LDEEE3560(1)A5N00
100	63	0.68	E	2824	6.1	4.1	7.3	100	DEEE3680(1)A5N00	LDEEE3680(1)A5N00
100	63	0.82	F	4030	7.9	2.8	10.5	100	DEEF3820(1)A5N00	LDEEF3820(1)A5N00
100	63	0.82	E	2824	6.1	4.9	7.3	100	DEEE3820(1)A0N00	LDEEE3820(1)A0N00
100	63	1.0	F	4030	7.9	3.2	10.5	100	DEEF4100(1)A5N00	LDEEF4100(1)A5N00
100	63	1.0	E	2824	6.1	5.4	7.3	100	DEEE4100(2)A0N00	LDEEE4100(2)A0N00
100	63	1.2	G	5040	10.4	3.1	13.0	100	DEEG4120(1)A5N00	LDEEG4120(1)A5N00
100	63	1.2	F	4030	7.9	3.7	10.5	100	DEEF4120(1)A0N00	LDEEF4120(1)A0N00
100	63	1.5	G	5040	10.4	3.1	13.0	100	DEEG4150(1)A5N00	LDEEG4150(1)A5N00
100	63	1.5	F	4030	7.9	4.5	10.5	100	DEEF4150(1)A0N00	LDEEF4150(1)A0N00
100	63	1.8	G	5040	10.4	3.4	13.0	100	DEEG4180(1)A5N00	LDEEG4180(1)A5N00
100	63	1.8	F	4030	7.9	5.4	10.5	100	DEEF4180(1)A0N00	LDEEF4180(1)A0N00
100	63	2.2	G	5040	10.4	4.1	13.0	100	DEEG4220(1)A5N00	LDEEG4220(1)A5N00
100	63	2.2	F	4030	7.9	5.6	10.5	100	DEEF4220(2)A0N00	LDEEF4220(2)A0N00
100	63	2.7	H	6054	13.7	3.3	15.5	100	DEEH4270(1)A5N00	LDEEH4270(1)A5N00
100	63	2.7	G	5040	10.4	4.9	13.0	100	DEEG4270(1)A0N00	LDEEG4270(1)A0N00
100	63	3.3	H	6054	13.7	3.9	15.5	100	DEEH4330(1)A5N00	LDEEH4330(1)A5N00
100	63	3.3	G	5040	10.4	5.7	13.0	100	DEEG4330(1)A0N00	LDEEG4330(1)A0N00
100	63	3.9	H	6054	13.7	4.5	15.5	100	DEEH4390(1)A5N00	LDEEH4390(1)A5N00
100	63	4.7	H	6054	13.7	5.3	15.5	100	DEEH4470(1)A5N00	LDEEH4470(1)A5N00
250	120	0.001	A	1206	1.7	1.1	3.3	100	DEIA1100(1)A0N00	LDEIA1100(1)A0N00
250	120	0.0012	A	1206	1.7	1.1	3.3	100	DEIA1120(1)A0N00	LDEIA1120(1)A0N00
250	120	0.0015	C	1812	3.3	1.7	4.7	100	DEIC1150(1)A5N00	LDEIC1150(1)A5N00
250	120	0.0015	A	1206	1.7	1.1	3.3	100	DEIA1150(1)A0N00	LDEIA1150(1)A0N00
250	120	0.0018	C	1812	3.3	1.7	4.7	100	DEIC1180(1)A5N00	LDEIC1180(1)A5N00
250	120	0.0018	A	1206	1.7	1.1	3.3	100	DEIA1180(1)A0N00	LDEIA1180(1)A0N00

(1) K = ±10%, M = ±20%, J = ±5% on request.

(2) Only K and M tolerances available.

OBSOLETE

Surface Mount Polyethylene Naphthalate (PEN) Film Capacitor

LDE, Unencapsulated Stacked Chip, Size 1206 – 6054, 50 – 1,000 VDC (Automotive Grade)

Table 1 – Ratings & Part Number Reference cont.

VDC	VAC	Capacitance Value (µF)	Size Code	Chip Size	Dimensions in mm			dV/dt (V/µs)	New KEMET Part Number	Legacy Part Number
					W	H (max)	L			
250	120	0.0022	C	1812	3.3	1.7	4.7	100	DEIC1220(1)A5N00	LDEIC1220(1)A5N00
250	120	0.0022	A	1206	1.7	1.1	3.3	100	DEIA1220(1)A0N00	LDEIA1220(1)A0N00
250	120	0.0027	C	1812	3.3	1.8	4.7	100	DEIC1270(1)A5N00	LDEIC1270(1)A5N00
250	120	0.0027	A	1206	1.7	1.1	3.3	100	DEIA1270(1)A0N00	LDEIA1270(1)A0N00
250	120	0.0033	C	1812	3.3	1.7	4.7	100	DEIC1330(1)A5N00	LDEIC1330(1)A5N00
250	120	0.0033	A	1206	1.7	1.2	3.3	100	DEIA1330(1)A0N00	LDEIA1330(1)A0N00
250	120	0.0039	C	1812	3.3	1.7	4.7	100	DEIC1390(1)A5N00	LDEIC1390(1)A5N00
250	120	0.0039	B	1210	2.5	1.6	3.3	100	DEIB1390(1)A0N00	LDEIB1390(1)A0N00
250	120	0.0047	C	1812	3.3	1.8	4.7	100	DEIC1470(1)A5N00	LDEIC1470(1)A5N00
250	120	0.0047	B	1210	2.5	1.6	3.3	100	DEIB1470(1)A0N00	LDEIB1470(1)A0N00
250	120	0.0056	C	1812	3.3	1.7	4.7	100	DEIC1560(1)A5N00	LDEIC1560(1)A5N00
250	120	0.0056	B	1210	2.5	1.6	3.3	100	DEIB1560(1)A0N00	LDEIB1560(1)A0N00
250	120	0.0068	C	1812	3.3	1.7	4.7	100	DEIC1680(1)A5N00	LDEIC1680(1)A5N00
250	120	0.0068	B	1210	2.5	1.8	3.3	100	DEIB1680(1)A0N00	LDEIB1680(1)A0N00
250	120	0.0082	C	1812	3.3	1.8	4.7	100	DEIC1820(1)A5N00	LDEIC1820(1)A5N00
250	120	0.0082	B	1210	2.5	2.0	3.3	100	DEIB1820(1)A0N00	LDEIB1820(1)A0N00
250	120	0.01	C	1812	3.3	1.7	4.7	100	DEIC2100(1)A5N00	LDEIC2100(1)A5N00
250	120	0.01	B	1210	2.5	2.1	3.3	100	DEIB2100(1)A0N00	LDEIB2100(1)A0N00
250	120	0.012	C	1812	3.3	1.7	4.7	100	DEIC2120(1)A5N00	LDEIC2120(1)A5N00
250	120	0.015	C	1812	3.3	1.7	4.7	100	DEIC2150(1)A5N00	LDEIC2150(1)A5N00
250	120	0.018	D	2220	5.0	2.2	6.0	100	DEID2180(1)A5N00	LDEID2180(1)A5N00
250	120	0.018	C	1812	3.3	1.8	4.7	100	DEIC2180(1)A0N00	LDEIC2180(1)A0N00
250	120	0.022	D	2220	5.0	2.5	6.0	100	DEID2220(1)A5N00	LDEID2220(1)A5N00
250	120	0.022	C	1812	3.3	2.2	4.7	100	DEIC2220(1)A0N00	LDEIC2220(1)A0N00
250	120	0.027	D	2220	5.0	2.9	6.0	100	DEID2270(1)A5N00	LDEID2270(1)A5N00
250	120	0.027	C	1812	3.3	2.5	4.7	100	DEIC2270(1)A0N00	LDEIC2270(1)A0N00
250	120	0.033	D	2220	5.0	1.9	6.0	100	DEID2330(1)A5N00	LDEID2330(1)A5N00
250	120	0.033	C	1812	3.3	2.6	4.7	100	DEIC2330(1)A0N00	LDEIC2330(1)A0N00
250	120	0.039	D	2220	5.0	2.1	6.0	100	DEID2390(1)A5N00	LDEID2390(1)A5N00
250	120	0.047	D	2220	5.0	2.3	6.0	100	DEID2470(1)A5N00	LDEID2470(1)A5N00
250	120	0.056	D	2220	5.0	2.6	6.0	100	DEID2560(1)A5N00	LDEID2560(1)A5N00
250	120	0.068	D	2220	5.0	2.8	6.0	100	DEID2680(1)A5N00	LDEID2680(1)A5N00
250	120	0.082	E	2824	6.1	2.6	7.3	100	DEIE2820(1)A5N00	LDEIE2820(1)A5N00
250	120	0.082	D	2220	5.0	3.5	6.0	100	DEID2820(1)A0N00	LDEID2820(1)A0N00
250	120	0.1	E	2824	6.1	2.9	7.3	100	DEIE3100(1)A5N00	LDEIE3100(1)A5N00
250	120	0.1	D	2220	5.0	4.1	6.0	100	DEID3100(1)A0N00	LDEID3100(1)A0N00
250	120	0.12	E	2824	6.1	3.3	7.3	100	DEIE3120(1)A5N00	LDEIE3120(1)A5N00
250	120	0.12	D	2220	5.0	4.4	6.0	100	DEID3120(1)A0N00	LDEID3120(1)A0N00
250	120	0.15	E	2824	6.1	3.8	7.3	100	DEIE3150(1)A5N00	LDEIE3150(1)A5N00
250	120	0.18	F	4030	7.9	2.7	10.5	100	DEIF3180(1)A5N00	LDEIF3180(1)A5N00
250	120	0.18	E	2824	6.1	4.4	7.3	100	DEIE3180(1)A0N00	LDEIE3180(1)A0N00
250	120	0.22	F	4030	7.9	3.1	10.5	100	DEIF3220(1)A5N00	LDEIF3220(1)A5N00
250	120	0.22	E	2824	6.1	5.2	7.3	100	DEIE3220(1)A0N00	LDEIE3220(1)A0N00
250	120	0.27	F	4030	7.9	3.7	10.5	100	DEIF3270(1)A5N00	LDEIF3270(1)A5N00
250	120	0.33	F	4030	7.9	4.3	10.5	100	DEIF3330(1)A5N00	LDEIF3330(1)A5N00
250	120	0.39	G	5040	10.4	3.3	13.0	100	DEIG3390(1)A5N00	LDEIG3390(1)A5N00
250	120	0.39	F	4030	7.9	5.0	10.5	100	DEIF3390(1)A0N00	LDEIF3390(1)A0N00
250	120	0.47	G	5040	10.4	3.8	13.0	100	DEIG3470(1)A5N00	LDEIG3470(1)A5N00
250	120	0.47	F	4030	7.9	5.5	10.5	100	DEIF3470(1)A0N00	LDEIF3470(1)A0N00
250	120	0.56	G	5040	10.4	4.4	13.0	100	DEIG3560(1)A5N00	LDEIG3560(1)A5N00
250	120	0.56	F	4030	7.9	5.5	10.5	100	DEIF3560(1)A0N00	LDEIF3560(1)A0N00
250	120	0.68	H	6054	13.7	3.4	15.5	100	DEIH3680(1)A5N00	LDEIH3680(1)A5N00
250	120	0.68	G	5040	10.4	5.2	13.0	100	DEIG3680(1)A0N00	LDEIG3680(1)A0N00
250	120	0.82	H	6054	13.7	3.9	15.5	100	DEIH3820(1)A5N00	LDEIH3820(1)A5N00
250	120	0.82	G	5040	10.4	5.7	13.0	100	DEIG3820(1)A0N00	LDEIG3820(1)A0N00
250	120	1.0	H	6054	13.7	4.6	15.5	100	DEIH4100(1)A5N00	LDEIH4100(1)A5N00
250	120	1.2	H	6054	13.7	5.4	15.5	100	DEIH4120(1)A0N00	LDEIH4120(1)A0N00
250	120	1.5	H	6054	13.7	5.7	15.5	100	DEIH4150(1)A0N00	LDEIH4150(1)A0N00
400	160	0.015	D	2220	5.0	2.1	6.0	100	DEMD2150(1)A5N00	LDEMD2150(1)A5N00
VDC	VAC	Capacitance Value (µF)	Size Code	Chip Size	W (mm)	H (mm)	L (mm)	dV/dt (V/µs)	New KEMET Part Number	Legacy Part Number

(1) K = ±10%, M = ±20%, J = ±5% on request.

(2) Only K and M tolerances available.

OBSOLETE

Surface Mount Polyethylene Naphthalate (PEN) Film Capacitor

LDE, Unencapsulated Stacked Chip, Size 1206 – 6054, 50 – 1,000 VDC (Automotive Grade)

Table 1 – Ratings & Part Number Reference cont.

VDC	VAC	Capacitance Value (µF)	Size Code	Chip Size	Dimensions in mm			dV/dt (V/µs)	New KEMET Part Number	Legacy Part Number
					W	H (max)	L			
400	160	0.018	D	2220	5.0	2.2	6.0	100	DEMD2180(1)A5N00	LDEMD2180(1)A5N00
400	160	0.022	D	2220	5.0	2.5	6.0	100	DEMD2220(1)A5N00	LDEMD2220(1)A5N00
400	160	0.027	D	2220	5.0	2.9	6.0	100	DEMD2270(1)A5N00	LDEMD2270(1)A5N00
400	160	0.033	D	2220	5.0	3.4	6.0	100	DEMD2330(1)A5N00	LDEMD2330(1)A5N00
400	160	0.039	D	2220	5.0	3.8	6.0	100	DEMD2390(1)A5N00	LDEMD2390(1)A5N00
400	160	0.047	D	2220	5.0	4.4	6.0	100	DEMD2470(1)A5N00	LDEMD2470(1)A5N00
400	160	0.056	E	2824	6.1	3.5	7.3	100	DEME2560(1)A5N00	LDEME2560(1)A5N00
400	160	0.068	E	2824	6.1	4.1	7.3	100	DEME2680(1)A5N00	LDEME2680(1)A5N00
400	160	0.082	E	2824	6.1	4.7	7.3	100	DEME2820(1)A5N00	LDEME2820(1)A5N00
400	160	0.1	E	2824	6.1	5.4	7.3	100	DEME3100(1)A5N00	LDEME3100(1)A5N00
400	160	0.12	F	4030	7.9	3.6	10.5	100	DEMF3120(1)A5N00	LDEMF3120(1)A5N00
400	160	0.15	F	4030	7.9	4.4	10.5	100	DEMF3150(1)A5N00	LDEMF3150(1)A5N00
400	160	0.18	F	4030	7.9	5.1	10.5	100	DEMF3180(1)A5N00	LDEMF3180(1)A5N00
400	160	0.22	G	5040	10.4	3.8	13.0	100	DEMG3220(1)A5N00	LDEMG3220(1)A5N00
400	160	0.27	G	5040	10.4	4.7	13.0	100	DEMG3270(1)A5N00	LDEMG3270(1)A5N00
400	160	0.33	G	5040	10.4	5.6	13.0	100	DEMG3330(1)A5N00	LDEMG3330(1)A5N00
400	160	0.39	H	6054	13.7	4.2	15.5	100	DEMH3390(1)A5N00	LDEMH3390(1)A5N00
400	160	0.47	H	6054	13.7	5.3	15.5	100	DEMH3470(1)A5N00	LDEMH3470(1)A5N00
630	200	0.001	D	2220	5.0	1.9	6.0	100	DEPD1100(1)A5N00	LDEPD1100(1)A5N00
630	200	0.0012	D	2220	5.0	2.0	6.0	100	DEPD1120(1)A5N00	LDEPD1120(1)A5N00
630	200	0.0015	D	2220	5.0	2.3	6.0	100	DEPD1150(1)A5N00	LDEPD1150(1)A5N00
630	200	0.0018	D	2220	5.0	2.5	6.0	100	DEPD1180(1)A5N00	LDEPD1180(1)A5N00
630	200	0.0022	D	2220	5.0	2.0	6.0	100	DEPD1220(1)A5N00	LDEPD1220(1)A5N00
630	200	0.0027	D	2220	5.0	2.3	6.0	100	DEPD1270(1)A5N00	LDEPD1270(1)A5N00
630	200	0.0033	D	2220	5.0	2.6	6.0	100	DEPD1330(1)A5N00	LDEPD1330(1)A5N00
630	200	0.0039	D	2220	5.0	1.9	6.0	100	DEPD1390(1)A5N00	LDEPD1390(1)A5N00
630	200	0.0047	D	2220	5.0	2.0	6.0	100	DEPD1470(1)A5N00	LDEPD1470(1)A5N00
630	200	0.0056	D	2220	5.0	2.0	6.0	100	DEPD1560(1)A5N00	LDEPD1560(1)A5N00
630	200	0.0068	D	2220	5.0	2.3	6.0	100	DEPD1680(1)A5N00	LDEPD1680(1)A5N00
630	200	0.0082	D	2220	5.0	2.6	6.0	100	DEPD1820(1)A5N00	LDEPD1820(1)A5N00
630	200	0.010	D	2220	5.0	3.0	6.0	100	DEPD2100(1)A5N00	LDEPD2100(1)A5N00
630	200	0.012	D	2220	5.0	3.4	6.0	100	DEPD2120(1)A5N00	LDEPD2120(1)A5N00
630	200	0.015	D	2220	5.0	4.0	6.0	100	DEPD2150(1)A5N00	LDEPD2150(1)A5N00
630	200	0.018	D	2220	5.0	4.4	6.0	100	DEPD2180(1)A5N00	LDEPD2180(1)A5N00
630	200	0.022	E	2824	6.1	3.4	7.3	100	DEPE2220(1)A5N00	LDEPE2220(1)A5N00
630	200	0.027	E	2824	6.1	4.0	7.3	100	DEPE2270(1)A5N00	LDEPE2270(1)A5N00
630	200	0.033	E	2824	6.1	4.7	7.3	100	DEPE2330(1)A5N00	LDEPE2330(1)A5N00
630	200	0.039	E	2824	6.1	5.3	7.3	100	DEPE2390(1)A5N00	LDEPE2390(1)A5N00
630	200	0.047	F	4030	7.9	3.4	10.5	100	DEPF2470(1)A5N00	LDEPF2470(1)A5N00
630	200	0.056	F	4030	7.9	3.9	10.5	100	DEPF2560(1)A5N00	LDEPF2560(1)A5N00
630	200	0.068	F	4030	7.9	4.5	10.5	100	DEPF2680(1)A5N00	LDEPF2680(1)A5N00
630	200	0.082	F	4030	7.9	5.4	10.5	100	DEPF2820(1)A5N00	LDEPF2820(1)A5N00
630	200	0.1	G	5040	10.4	3.9	13.0	100	DEPG3100(1)A5N00	LDEPG3100(1)A5N00
630	200	0.1	F	4030	7.9	5.5	10.5	100	DEPF3100(2)A0N00	LDEPF3100(2)A0N00
630	200	0.12	G	5040	10.4	4.4	13.0	100	DEPG3120(1)A5N00	LDEPG3120(1)A5N00
630	200	0.15	G	5040	10.4	5.3	13.0	100	DEPG3150(1)A5N00	LDEPG3150(1)A5N00
630	200	0.18	H	6054	13.7	4.2	15.5	100	DEPH3180(1)A5N00	LDEPH3180(1)A5N00
630	200	0.22	H	6054	13.7	4.9	15.5	100	DEPH3220(1)A5N00	LDEPH3220(1)A5N00
630	200	0.27	H	6054	13.7	5.7	15.5	100	DEPH3270(2)A5N00	LDEPH3270(2)A5N00
1000	250	0.001	D	2220	5.0	1.9	6.0	300	DEQD1100(1)A5N00	LDEQD1100(1)A5N00
1000	250	0.0012	D	2220	5.0	2.0	6.0	300	DEQD1120(1)A5N00	LDEQD1120(1)A5N00
1000	250	0.0015	D	2220	5.0	2.3	6.0	300	DEQD1150(1)A5N00	LDEQD1150(1)A5N00
1000	250	0.0018	D	2220	5.0	2.5	6.0	300	DEQD1180(1)A5N00	LDEQD1180(1)A5N00
1000	250	0.0022	D	2220	5.0	2.0	6.0	300	DEQD1220(1)A5N00	LDEQD1220(1)A5N00
1000	250	0.0027	D	2220	5.0	2.3	6.0	300	DEQD1270(1)A5N00	LDEQD1270(1)A5N00
1000	250	0.0033	D	2220	5.0	2.6	6.0	300	DEQD1330(1)A5N00	LDEQD1330(1)A5N00
1000	250	0.0039	D	2220	5.0	3.0	6.0	300	DEQD1390(1)A5N00	LDEQD1390(1)A5N00
1000	250	0.0047	D	2220	5.0	3.4	6.0	300	DEQD1470(1)A5N00	LDEQD1470(1)A5N00
1000	250	0.0056	D	2220	5.0	3.9	6.0	300	DEQD1560(1)A5N00	LDEQD1560(1)A5N00
VDC	VAC	Capacitance Value (µF)	Size Code	Chip Size	W (mm)	H (mm)	L (mm)	dV/dt (V/µs)	New KEMET Part Number	Legacy Part Number

(1) K = ±10%, M = ±20%, J = ±5% on request.

(2) Only K and M tolerances available.

OBSOLETE

Surface Mount Polyethylene Naphthalate (PEN) Film Capacitor

LDE, Unencapsulated Stacked Chip, Size 1206 – 6054, 50 – 1,000 VDC (Automotive Grade)

Table 1 – Ratings & Part Number Reference cont.

VDC	VAC	Capacitance Value (μF)	Size Code	Chip Size	Dimensions in mm			dV/dt (V/μs)	New KEMET Part Number	Legacy Part Number
					W	H (max)	L			
1000	250	0.0068	D	2220	5.0	4.4	6.0	300	DEQD1680(1)A5N00	LDEQD1680(1)A5N00
1000	250	0.0082	E	2824	6.1	2.9	7.3	300	DEQE1820(1)A5N00	LDEQE1820(1)A5N00
1000	250	0.010	E	2824	6.1	3.4	7.3	300	DEQE2100(1)A5N00	LDEQE2100(1)A5N00
1000	250	0.012	E	2824	6.1	4.0	7.3	300	DEQE2120(1)A5N00	LDEQE2120(1)A5N00
1000	250	0.015	E	2824	6.1	4.9	7.3	300	DEQE2150(1)A5N00	LDEQE2150(1)A5N00
1000	250	0.018	E	2824	6.1	5.4	7.3	300	DEQE2180(1)A5N00	LDEQE2180(1)A5N00
1000	250	0.022	F	4030	7.9	3.4	10.5	300	DEQF2220(1)A5N00	LDEQF2220(1)A5N00
1000	250	0.027	F	4030	7.9	4.1	10.5	300	DEQF2270(1)A5N00	LDEQF2270(1)A5N00
1000	250	0.033	F	4030	7.9	4.9	10.5	300	DEQF2330(1)A5N00	LDEQF2330(1)A5N00
1000	250	0.039	G	5040	10.4	3.5	13.0	300	DEQG2390(1)A5N00	LDEQG2390(1)A5N00
1000	250	0.047	G	5040	10.4	4.1	13.0	300	DEQG2470(1)A5N00	LDEQG2470(1)A5N00
1000	250	0.056	G	5040	10.4	4.7	13.0	300	DEQG2560(1)A5N00	LDEQG2560(1)A5N00
1000	250	0.068	G	5040	10.4	5.5	13.0	300	DEQG2680(1)A5N00	LDEQG2680(1)A5N00
1000	250	0.082	H	6054	13.7	4.2	15.5	300	DEQH2820(1)A5N00	LDEQH2820(1)A5N00
1000	250	0.1	H	6054	13.7	4.8	15.5	300	DEQH3100(1)A5N00	LDEQH3100(1)A5N00
VDC	VAC	Capacitance Value (μF)	Size Code	Chip Size	W (mm)	H (mm)	L (mm)	dV/dt (V/μs)	New KEMET Part Number	Legacy Part Number

(1) K = ±10%, M = ±20%, J = ±5% on request.

(2) Only K and M tolerances available.

Soldering Process

Reflow Recommendations	
Preheating	
Maximum Preheating Time	180 seconds
Minimum Temperature	150°C
Maximum Temperature	200°C
Solder Flow	
Maximum Time within T_{max} and $T_{max} - 5^{\circ}\text{C}$ (ΔT_5)	30 seconds ($T_{max} \leq 250^{\circ}\text{C}$)
	10 seconds ($250^{\circ}\text{C} < T_{max} \leq 255^{\circ}\text{C}$)
Maximum Time Over 217°C (ΔT_{217})	150 seconds
Maximum Temperature Ramp Rate	3°C/seconds (heating)
	6°C/seconds (cooling)
Second reflow	
If two reflow processes are needed, be sure that before the second reflow the temperature on the capacitor's surface is lower than 50°C.	

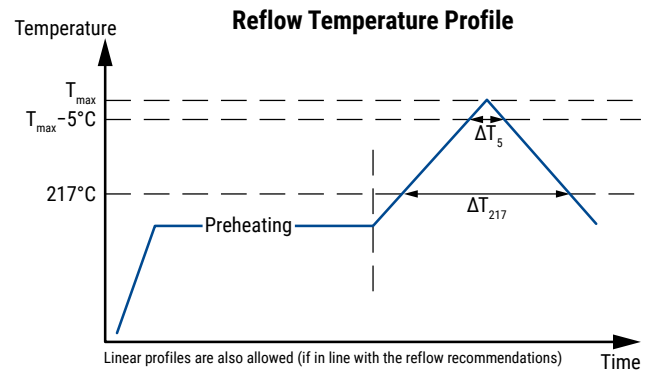

Maximum Temperature on Component Body (T_{max})

Capacitor	Capacitor Volume (mm^3)		
H_{max} (mm)	< 350	350 – 2,000	> 2,000
< 1.6	255°C	255°C	255°C
1.6 – 2.5	255°C	250°C	245°C
> 2.5	250°C	245°C	245°C

*In line with JEDEC STD 020 with some limitations.

Flux/Cleaning/Storage and Moisture

Flux suggestions

KEMET suggests to use a no-clean flux with a halogen content lower than 0.1%.

Cleaning suggestions

To clean the PCB assembly, KEMET recommends using a suitable solvent like Isopropyl alcohol, deionized water, or neutral pH detergents. Aggressive solvents shall not be used. For any different cleaning solvent used, please contact KEMET Technical Services to analyze the potential impact on KEMET products.

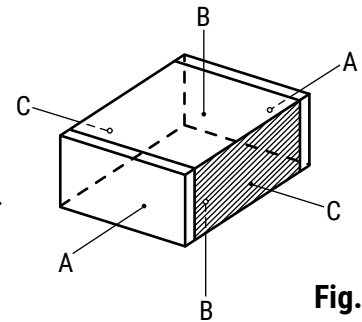

Fig. 1

Storage and moisture recommendations

KEMET SMD Film Capacitors are supplied in a MBB (Moisture Barrier Bag) Class 1. We can guarantee a 24 month shelf life (temperature $\leq 40^{\circ}\text{C}$ /relative humidity $\leq 90\%$). After the MBB has been opened, components may stay in areas with controlled temperature and humidity (temperature $\leq 30^{\circ}\text{C}$ /relative humidity $\leq 60\%$) for 168 hours [MSL 3] (rated voltage ≤ 100 VDC) or 696 hours [MSL 2a] (rated voltage > 100 VDC). For longer periods of time and/or higher temperature and/or higher relative humidity values, it is absolutely necessary to protect the components against humidity. If the reel inside the MBB is partially used, KEMET recommends to re-use the same MBB or avoid areas without controlled temperature and humidity (see above). If the above conditions are not respected, components require baking (minimum time: 48 hours at $55 \pm 5^{\circ}\text{C}$) before the reflow.

Manual assembly recommendations

If PCBs are assembled manually, care must be taken to avoid any mechanical damage to the components.

Our recommendations are the following (see Fig. 1):

- 1) When using tweezers, the components should be gripped across the two terminations (A)
- 2) Avoid any contact with the two cutting surfaces (C)
- 3) A vacuum pen is recommended on the top and bottom surfaces (B)

Flux/Cleaning/Storage and Moisture cont.

Manual soldering recommendations

LDE and LDB series have been designed for Surface Mount Technology, pick-and- place machines, and reflow soldering systems. Issues may occur using a manual soldering iron because the typical temperature for manual soldering is approximately 350°C. Therefore please pay careful attention:

- Never touch the capacitor body with the soldering iron but rather touch the soldering iron and the end termination with the tin wire edge (see Figure 2)
- If the soldering iron is equipped with a temperature controlling device, set the temperature to $250 \pm 3^\circ\text{C}$ and proceed as per Figure 2 (the maximum soldering time, on both terminations, is 5 seconds)
- A soldering iron that is NOT equipped with a temperature controlling device is not an ideal situation and operator experience is extremely important in this case. If you have a soldering iron that does not have a temperature controlling device, please use the following practical suggestions:
 - 1) Proceed as per Figure 2
 - 2) As soon as the tin wire starts melting, move the soldering iron away as quickly as possible
 - 3) Wait a few seconds and check that the soldering joint has been properly created
- If the soldering iron is equipped with a hot air flow device, set the hot air temperature to $250 \pm 3^\circ\text{C}$ and do not send the hot air directly onto the capacitor plastic body. In this situation, the operator's experience is very important.
- In any case, avoid mass-mounting SMD Film Capacitors manually.

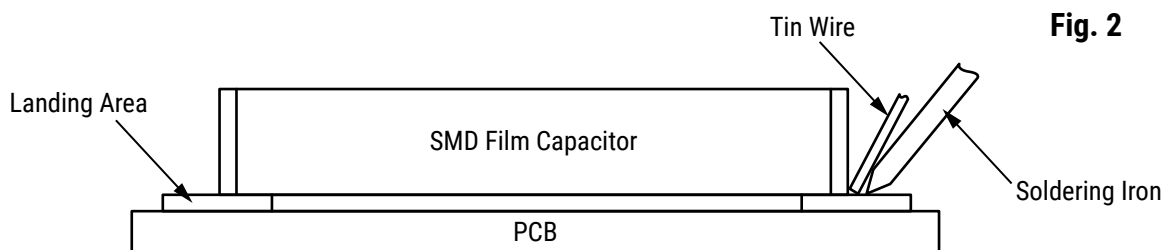

Fig. 2

Packaging Quantities

Chip Size (EIA)	Height (mm)	Reel
1206	All	3,000
1210	All	2,250
1812	≤ 1.9	4,000
1812	2.1 – 2.6	3,000
2220	≤ 2.8	3,000
2220	2.9 – 3.7	2,250
2220	3.8 – 4.4	1,750
2824	2.6 – 3.6	2,250
2824	3.8 – 4.4	1,750
2824	4.7 – 5.4	1,500
4030	2.7 – 3.7	1,500
4030	3.9 – 4.5	1,250
4030	4.7 – 5.6	1,000
5040	3.1 – 3.5	1,500
5040	3.8 – 4.4	1,250
5040	4.7 – 5.7	1,000
6054	3.3 – 4.2	1,000
6054	4.5 – 4.9	750
6054	5.3 – 5.7	750

Production Process Basic Suggestions

In case of:	Typical cause	Typical solution
No solder joint on one end termination	Landing area dimensions	See landing areas suggestions, page 17
	Solder paste quality	See solder paste suggestions, page 17
	Not-uniform solder paste thickness on the landing areas	Set the dispensing solder paste machine properly
	Wrong position of the capacitor on the landing areas	Set the pick and place machine properly
	Thermal profile temperature	See reflow recommendations, page 14
	Bad temperature distribution in the reflow oven	Check the reflow oven temperature distribution and variations
No solder joint on both end termination	Landing area dimensions	See landing areas suggestions, page 17
	Solder paste quality	See solder paste suggestions, page 17
	No solder paste on the landing areas	Set the dispensing solder paste machine properly
	Thermal profile temperature	See reflow recommendations, page 14
	Bad temperature distribution in the reflow oven	Check the reflow oven temperature distribution and variations
	Oxidated end terminations	See moisture recommendations, page 15
Capacitor's body mechanical deformation	Too long time over 217°C	See reflow recommendations, page 14
	Too long time within T_{max} and $T_{max} - 5^{\circ}C$	See reflow recommendations, page 14
	Too high temperature ramp rate	See reflow recommendations, page 14
	Capacitor damaged by a soldering iron	See manual soldering recommendations, page 16
Capacitance drop (up to 20%)	Too long time over 217°C	See reflow recommendations, page 14
	Too long time within T_{max} and $T_{max} - 5^{\circ}C$	See reflow recommendations, page 14
	Too high temperature ramp rate	See reflow recommendations, page 14
	Capacitor damaged by a soldering iron	See manual soldering recommendations, page 16
Capacitance drop (over 20%)	Capacitor damaged by a soldering iron	See manual soldering recommendations, page 16

Note: Small fissures on the capacitor's cutting surface are actually slight detachments of two adjacent metallized film layers and have to be considered only as an aesthetic issue related to the SMD Film Capacitors' manufacturing process and technology.

Therefore, small fissures on SMD Film Capacitors are not comparable to cracks on SMD Ceramics.

Fissures do not influence SMD Film Capacitors' reliability in any way.

Carrier Taping & Packaging (IEC 60286-3)

Horizontal Taping Orientation

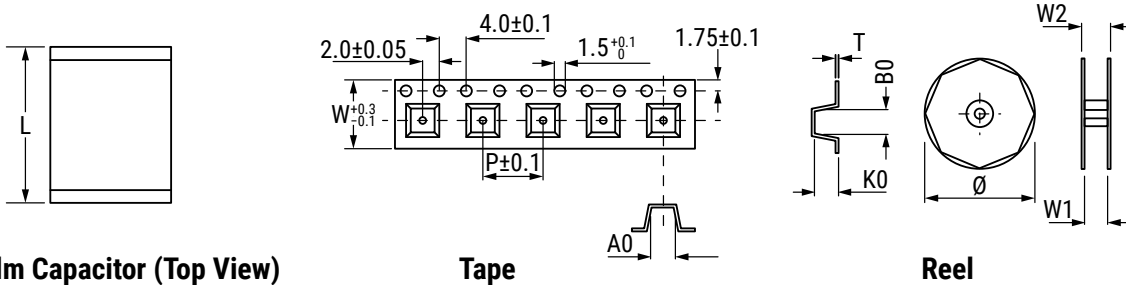

SMD Film Capacitor (Top View)

Tape

Reel

Chip Size (EIA) Horizontal Mounting	Dimensions in mm			Taping Specification							
	W	H	L	W	P ₁	A ₀	B ₀	K ₀	D	W ₁	W ₂
	Nominal	Nominal	Nominal	-0.1/+0.3	±0.1	Nominal	Nominal	Nominal	±2.0	-0/+2	Maximum
1206	1.7	All	3.3	8.0	4.0	2.0	3.8	1.3	180	8.0	12.0
1210	2.5	All	3.3	8.0	4.0	3.0	3.8	2.1	180	8.0	12.0
1812	3.3	≤ 1.9	4.7	12.0	8.0	3.8	5.3	2.0	330	12.0	16.0
1812	3.3	2.1 – 2.6	4.7	12.0	8.0	3.9	5.2	2.6	330	12.0	16.0
2220	5.0	≤ 2.8	6.0	12.0	8.0	5.5	6.5	2.9	330	12.0	16.0
2220	5.0	2.9 – 3.7	6.0	12.0	8.0	5.5	6.5	3.8	330	12.0	16.0
2220	5.0	3.8 – 4.4	6.0	12.0	8.0	5.5	6.5	4.9	330	12.0	16.0
2824	6.1	2.6 – 3.6	7.3	16.0	8.0	6.6	7.9	3.8	330	16.0	20.0
2824	6.1	3.8 – 4.4	7.3	16.0	8.0	6.6	7.9	4.6	330	16.0	20.0
2824	6.1	4.7 – 5.4	7.3	16.0	8.0	6.6	7.9	5.5	330	16.0	20.0
4030	7.9	2.7 – 3.7	10.5	16.0	12.0	8.6	11.0	3.8	330	16.0	20.0
4030	7.9	3.9 – 4.5	10.5	16.0	12.0	8.6	11.0	4.6	330	16.0	20.0
4030	7.9	4.7 – 5.6	10.5	16.0	12.0	8.6	11.0	5.8	330	16.0	20.0
5040	10.4	3.1 – 3.5	13.0	24.0	12.0	10.9	13.5	3.8	330	24.0	28.0
5040	10.4	3.8 – 4.4	13.0	24.0	12.0	10.9	13.5	4.7	330	24.0	28.0
5040	10.4	4.7 – 5.7	13.0	24.0	12.0	11.0	13.5	5.9	330	24.0	28.0
6054	13.7	3.3 – 4.2	15.5	24.0	16.0	14.4	16.0	4.3	330	24.0	28.0
6054	13.7	4.5 – 4.9	15.5	24.0	16.0	14.4	16.0	5.1	330	24.0	28.0
6054	13.7	5.3 – 5.7	15.5	24.0	16.0	14.4	16.0	5.8	330	24.0	28.0

In accordance with IEC 60286-3

Materials:

- carrier tape: antistatic material
- cover tape: polyester + polythene
- reel: recyclable polystyrene

All parts in reels are packed in hermetically sealed Moisture Barrier Bag (MBB) Class 1.

KEMET Electronics Corporation Sales Offices

For a complete list of our global sales offices, please visit www.kemet.com/sales.

Disclaimer

YAGEO Corporation and its affiliates do not recommend the use of commercial or automotive grade products for high reliability applications or manned space flight.

All product specifications, statements, information and data (collectively, the "Information") in this datasheet are subject to change. The customer is responsible for checking and verifying the extent to which the Information contained in this publication is applicable to an order at the time the order is placed. All Information given herein is believed to be accurate and reliable, but it is presented without guarantee, warranty, or responsibility of any kind, expressed or implied.

Statements of suitability for certain applications are based on KEMET Electronics Corporation's ("KEMET") knowledge of typical operating conditions for such applications, but are not intended to constitute – and KEMET specifically disclaims – any warranty concerning suitability for a specific customer application or use. The Information is intended for use only by customers who have the requisite experience and capability to determine the correct products for their application. Any technical advice inferred from this Information or otherwise provided by KEMET with reference to the use of KEMET's products is given gratis, and KEMET assumes no obligation or liability for the advice given or results obtained.

Although KEMET designs and manufactures its products to the most stringent quality and safety standards, given the current state of the art, isolated component failures may still occur. Accordingly, customer applications which require a high degree of reliability or safety should employ suitable designs or other safeguards (such as installation of protective circuitry or redundancies) in order to ensure that the failure of an electrical component does not result in a risk of personal injury or property damage.

Although all product-related warnings, cautions and notes must be observed, the customer should not assume that all safety measures are indicated or that other measures may not be required.

Additional information about production site flexibility can be found [here](#)

Looking for pricing, stock, or lifecycle information?

Click below to explore more details on WIN SOURCE:

 [View ERJ-6GEYJ103V on WIN SOURCE](#)

 [Panasonic Information](#)

Optimize Your Supply Chain with WIN SOURCE Solutions

-  Global Sourcing Solution
-  Obsolete Management
-  Cost Control Management
-  Shortage Management
-  Alternative Solution
-  Excess Inventory Management