



**THE DATASHEET OF
EEE-FP1E101AL**



MAX6043

Precision High-Voltage Reference in SOT23

General Description

The MAX6043 precision voltage reference provides accurate preset +2.5V, +3.3V, +4.096V, +5.0V, and +10V reference voltages from up to +40V input voltages. The MAX6043 features a proprietary temperature coefficient curvature-correction circuit and laser-trimmed thin-film resistors that result in a very low temperature coefficient of 15ppm/°C (max) and excellent initial accuracy of 0.05% (max). Low temperature drift and low noise make the MAX6043 ideal for use with high-resolution A/D or D/A converters.

The MAX6043 draws 320µA of supply current and sources 10mA or sinks 0.6mA of load current. The MAX6043 uses bandgap technology for low-noise performance and excellent accuracy. The MAX6043 does not require an output bypass capacitor for stability, and is stable with capacitive loads up to 100µF. Eliminating the output bypass capacitor saves valuable board area in space-critical applications. The supply-independent, low supply current makes the MAX6043 ideal for battery-operated, high-performance systems.

The MAX6043 is available in a 6-pin SOT23 package and operates over the automotive (-40°C to +125°C) temperature range.

Applications

- Analog-to-Digital Converters
- Digital-to-Analog Converters
- Digital Voltmeters
- Voltage Regulators
- Threshold Detectors

Ordering Information

| PART | OUTPUT VOLTAGE (V) | TEMPCO (PPM/°C) | INITIAL ACCURACY (%) | TOP MARK |
|--------------------|--------------------|-----------------|----------------------|----------|
| MAX6043AAUT25-T | 2.500 | 15 | 0.06 | ABRZ |
| MAX6043AAUT25#TG16 | 2.500 | 15 | 0.06 | #ACMH |
| MAX6043BAUT25-T | 2.500 | 20 | 0.10 | ABDQ |
| MAX6043BAUT25#TG16 | 2.500 | 20 | 0.10 | #ACMI |
| MAX6043CAUT25-T | 2.500 | 65 | 0.50 | ABDR |
| MAX6043CAUT25#TG16 | 2.500 | 65 | 0.50 | #ACMJ |
| MAX6043AAUT33-T | 3.300 | 15 | 0.06 | ABSA |
| MAX6043AAUT33#TG16 | 3.300 | 15 | 0.06 | #ACMK |
| MAX6043BAUT33-T | 3.300 | 20 | 0.10 | ABDS |
| MAX6043BAUT33#TG16 | 3.300 | 20 | 0.10 | #ACML |

#Denotes an RoHS-compliant device that may include lead that is exempt under the RoHS requirements.

T = Tape and reel.

Ordering Information continued at end of data sheet.

Typical Operating Circuit appears at end of data sheet.

Features

- +2.5V, +3.3V, +4.096V, +5.0V, or +10V Output Voltages
- Excellent Temperature Stability: 15ppm/°C (max)
- Tight Initial Accuracy: 0.05% (max)
- Tiny SOT23 Package
- Wide +4.5V to +40V Supply Voltage Range
- Low Noise: 4µV_{P-P} (typ at 2.5V Output)
- Short-Circuit Protected
- Wide Operating Temperature Range -40°C to +125°C
- Stable with Capacitive Loads from 0 to 100µF
- No External Capacitors Required for Stability

Pin Configuration

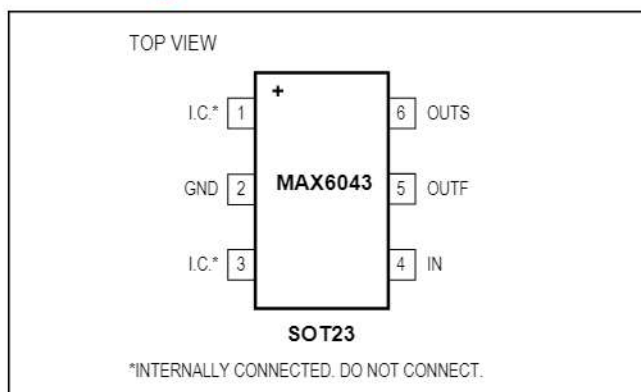

Absolute Maximum Ratings

IN to GND.....-0.3V to +42V
 OUT_F, OUT_S to GND.....-0.3V to (V_{IN} + 0.3V)
 Continuous Power Dissipation (T_A = +70°C)
 6-Pin SOT23 (derate 7.40mW/°C above +70°C) ...595.20mW
 OUT_F Short-Circuit Duration 5s
 Operating Temperature Range..... -40°C to +125°C
 Storage Temperature Range..... -65°C to +150°C

Junction Temperature Range -65°C to +150°C
 Maximum Junction Temperature +150°C
 Lead Temperature (soldering, 10s) +300°C
 Soldering Temperature (reflow)
 RoHS-compliant package..... +245°C
 Packages containing lead(Pb)..... +240°C

Package Information

6 SOT23

| PACKAGE CODE | U6F+6 |
|---|-------------------------|
| Outline Number | 21-0058 |
| Land Pattern Number | 90-0175 |
| Thermal Resistance, Single-Layer Board | |
| Junction to Ambient (θ _{JA}) | 185.50°C/W |
| Junction to Case (θ _{JC}) | 75°C/W |
| Thermal Resistance, Four-Layer Board | |
| Junction to Ambient (θ _{JA}) | 134.40°C/W |
| Junction to Case (θ _{JC}) | 39°C/W |

For the latest package outline information and land patterns (footprints), go to www.maximintegrated.com/packages. Note that a "+", "#", or "-" in the package code indicates RoHS status only. Package drawings may show a different suffix character, but the drawing pertains to the package regardless of RoHS status.

Package thermal resistances were obtained using the method described in JEDEC specification JESD51-7, using a four-layer board. For detailed information on package thermal considerations, refer to www.maximintegrated.com/thermal-tutorial.

Electrical Characteristics— $V_{OUT} = +2.5V$

(VIN = +5V, IOUT = 0, TA = TMIN to TMAX. Typical values are at TA = +25°C, unless otherwise noted.) (Note 1)

| PARAMETER | CONDITIONS | | MIN | TYP | MAX | UNITS |
|---|---|----------------------|--------|--------|--------|--------|
| OUTPUT | | | | | | |
| Output Voltage | IOUT = 0, TA = +25°C | MAX6043A (0.06%) | 2.4985 | 2.5000 | 2.5015 | V |
| | | MAX6043B (0.1%) | 2.4975 | 2.5000 | 2.5025 | |
| | | MAX6043C (0.5%) | 2.4876 | 2.5000 | 2.5125 | |
| Output-Voltage Temperature Coefficient (Note 2) | TA = -40°C to +125°C | MAX6043A_25 | | 3 | 15 | ppm/°C |
| | | MAX6043B_25 | | 5 | 25 | |
| | | MAX6043C_25 | | 10 | 65 | |
| Line Regulation (Note 4) | 4.5V < VIN < 40V | TA = +25°C | | 1 | 6 | ppm/V |
| | | TA = -40°C to +125°C | | 1.5 | 10 | |
| Load Regulation (Note 4) | Sourcing, 0 < IOUT < 10mA | TA = +25°C | | 8 | 70 | ppm/mA |
| | | TA = -40°C to +125°C | | | 70 | |
| | Sinking, -0.6mA < IOUT < 0mA | TA = +25°C | | 70 | 900 | |
| | | TA = -40°C to +125°C | | | 900 | |
| OUT Short-Circuit Current | Output shorted to GND | | | 60 | | mA |
| | Output shorted to IN | | | -2 | | |
| Thermal Hysteresis | (Note 3) | | | 150 | | ppm |
| Long-Term Stability | Δt = 1000hr | | | 150 | | ppm |
| DYNAMIC CHARACTERISTICS | | | | | | |
| Output Noise Voltage | 0.1Hz to 10Hz | | | 4 | | μVPP |
| | 10Hz to 1kHz | | | 7 | | μVRMS |
| Turn-On Settling Time | To VOUT = 0.05% of final value, COUT = 50pF | | | 150 | | μs |
| INPUT | | | | | | |
| Supply Voltage Range | Inferred from line regulation test | | 4.5 | | 40.0 | V |
| Quiescent Supply Current | IOUT = 0 | TA = +25°C | | 320 | 490 | μA |
| | | TA = -40°C to +125°C | | 370 | 650 | |

Electrical Characteristics— $V_{OUT} = +3.3V$

(VIN = +10V, IOUT = 0, TA = TMIN to TMAX. Typical values are at TA = +25°C, unless otherwise noted.) (Note 1)

| PARAMETER | CONDITIONS | | MIN | TYP | MAX | UNITS |
|---|---|----------------------|--------|--------|--------|--------|
| OUTPUT | | | | | | |
| Output Voltage | IOUT = 0, TA = +25°C | MAX6043A (0.06%) | 3.2980 | 3.3000 | 3.3020 | V |
| | | MAX6043B (0.1%) | 3.2967 | 3.3000 | 3.3033 | |
| | | MAX6043C (0.5%) | 3.2836 | 3.3000 | 3.3165 | |
| Output-Voltage Temperature Coefficient (Note 2) | TA = -40°C to +125°C | MAX6043A_33 | | 3 | 15 | ppm/°C |
| | | MAX6043B_33 | | 5 | 25 | |
| | | MAX6043C_33 | | 10 | 65 | |
| Line Regulation (Note 4) | 5.3V ≤ VIN ≤ 40V | TA = +25°C | | 1 | 6 | ppm/V |
| | | TA = -40°C to +125°C | | 1.5 | 10 | |
| Load Regulation (Note 4) | Sourcing, 0 ≤ IOUT ≤ 10mA | TA = +25°C | | 23 | 70 | ppm/mA |
| | | TA = -40°C to +125°C | | | 70 | |
| | Sinking, -0.6mA ≤ IOUT ≤ 0mA | TA = +25°C | | 100 | 900 | |
| | | TA = -40°C to +125°C | | | 900 | |
| OUT Short-Circuit Current | OUT shorted to GND | | | 60 | | mA |
| | OUT shorted to IN | | | -2 | | |
| Thermal Hysteresis | (Note 3) | | | 150 | | ppm |
| Long-Term Stability | Δt = 1000hr | | | 150 | | ppm |
| DYNAMIC CHARACTERISTICS | | | | | | |
| Output Noise Voltage | 0.1Hz to 10Hz | | | 5.3 | | μVPP |
| | 10Hz to 1kHz | | | 9.5 | | μVRMS |
| Turn-On Settling Time | To VOUT = 0.05% of final value, COUT = 50pF | | | 180 | | μs |
| INPUT | | | | | | |
| Supply Voltage Range | Inferred from line regulation test | | 5.3 | | 40.0 | V |
| Quiescent Supply Current | IOUT = 0 | TA = +25°C | | 320 | 490 | μA |
| | | TA = -40°C to +125°C | | 380 | 650 | |

Electrical Characteristics— $V_{OUT} = +4.096V$

(VIN = +10V, IOUT = 0, TA = TMIN to TMAX. Typical values are at TA = +25°C, unless otherwise noted.) (Note 1)

| PARAMETER | CONDITIONS | | MIN | TYP | MAX | UNITS |
|---|---|----------------------|--------|--------|--------|--------|
| OUTPUT | | | | | | |
| Output Voltage | IOUT = 0, TA = +25°C | MAX6043A (0.06%) | 4.0935 | 4.0960 | 4.0985 | V |
| | | MAX6043B (0.1%) | 4.0919 | 4.0960 | 4.1001 | |
| | | MAX6043C (0.5%) | 4.0755 | 4.0960 | 4.1165 | |
| Output-Voltage Temperature Coefficient (Note 2) | TA = -40°C to +125°C | MAX6043A_41 | | 3 | 15 | ppm/°C |
| | | MAX6043B_41 | | 5 | 25 | |
| | | MAX6043C_41 | | 10 | 65 | |
| Line Regulation (Note 4) | 6.1V ≤ VIN ≤ 40V | TA = +25°C | | 1 | 6 | ppm/V |
| | | TA = -40°C to +125°C | | 1.5 | 10 | |
| Load Regulation (Note 4) | Sourcing, 0 ≤ IOUT ≤ 10mA | TA = +25°C | | 19 | 70 | ppm/mA |
| | | TA = -40°C to +125°C | | | 70 | |
| | Sinking, -0.6mA ≤ IOUT ≤ 0mA | TA = +25°C | | 100 | 900 | |
| | | TA = -40°C to +125°C | | | 900 | |
| OUT Short-Circuit Current | OUT shorted to GND | | | 60 | | mA |
| | OUT shorted to IN | | | -2 | | |
| Thermal Hysteresis | (Note 3) | | | 150 | | ppm |
| Long-Term Stability | Δt = 1000hr | | | 150 | | ppm |
| DYNAMIC CHARACTERISTICS | | | | | | |
| Output Noise Voltage | 0.1Hz to 10Hz | | | 6.6 | | μVPP |
| | 10Hz to 1kHz | | | 12 | | μVRMS |
| Turn-On Settling Time | To VOUT = 0.05% of final value, COUT = 50pF | | | 200 | | μs |
| INPUT | | | | | | |
| Supply Voltage Range | Inferred from line regulation test | | 6.1 | | 40.0 | V |
| Quiescent Supply Current | IOUT = 0 | TA = +25°C | | 320 | 490 | μA |
| | | TA = -40°C to +125°C | | 380 | 650 | |

Electrical Characteristics— $V_{OUT} = +5.0V$ (V_{IN} = +15V, I_{OUT} = 0, T_A = T_{MIN} to T_{MAX}. Typical values are at T_A = +25°C, unless otherwise noted.) (Note 1)

| PARAMETER | CONDITIONS | | MIN | TYP | MAX | UNITS |
|---|---|----------------------------------|--------|--------|--------|-------------------|
| OUTPUT | | | | | | |
| Output Voltage | I _{OUT} = 0, T _A = +25°C | MAX6043A (0.06%) | 4.9970 | 5.0000 | 5.0030 | V |
| | | MAX6043B (0.1%) | 4.9950 | 5.0000 | 5.0050 | |
| | | MAX6043C (0.5%) | 4.9751 | 5.0000 | 5.0250 | |
| Output-Voltage Temperature Coefficient (Note 2) | T _A = -40°C to +125°C | MAX6043A_50 | | 3 | 15 | ppm/°C |
| | | MAX6043B_50 | | 5 | 25 | |
| | | MAX6043C_50 | | 10 | 65 | |
| Line Regulation (Note 4) | 7V ≤ V _{IN} ≤ 40V | T _A = +25°C | | 1 | 6 | ppm/V |
| | | T _A = -40°C to +125°C | | 1.5 | 10 | |
| Load Regulation (Note 4) | Sourcing, 0 ≤ I _{OUT} ≤ 10mA | T _A = +25°C | | 32 | 70 | ppm/mA |
| | | T _A = -40°C to +125°C | | | 70 | |
| | Sinking, -0.6mA ≤ I _{OUT} ≤ 0mA | T _A = +25°C | | 130 | 900 | |
| | | T _A = -40°C to +125°C | | | 900 | |
| OUT Short-Circuit Current | OUT shorted to GND | | | 60 | | mA |
| | OUT shorted to IN | | | -2 | | |
| Thermal Hysteresis | (Note 3) | | | 150 | | ppm |
| Long-Term Stability | Δt = 1000hr | | | 150 | | ppm |
| DYNAMIC CHARACTERISTICS | | | | | | |
| Output Noise Voltage | 0.1Hz to 10Hz | | | 9.5 | | μV _{P-P} |
| | 10Hz to 1kHz | | | 15 | | μV _{RMS} |
| Turn-On Settling Time | To V _{OUT} = 0.05% of final value, C _{OUT} = 50pF | | | 230 | | μs |
| INPUT | | | | | | |
| Supply Voltage Range | Inferred from line regulation test | | 7.0 | | 40.0 | V |
| Quiescent Supply Current | I _{OUT} = 0 | T _A = +25°C | | 320 | 490 | μA |
| | | T _A = -40°C to +125°C | | 380 | 650 | |

Electrical Characteristics— $V_{OUT} = +10.0V$

($V_{IN} = +15V$, $I_{OUT} = 0$, $T_A = T_{MIN}$ to T_{MAX} . Typical values are at $T_A = +25^\circ C$, unless otherwise noted.) (Note 1)

| PARAMETER | CONDITIONS | | MIN | TYP | MAX | UNITS |
|---|--|---------------------------------------|--------|---------|---------|-----------------|
| OUTPUT | | | | | | |
| Output Voltage | $I_{OUT} = 0$, $T_A = +25^\circ C$ | MAX6043A (0.05%) | 9.9950 | 10.0000 | 10.0050 | V |
| | | MAX6043B (0.1%) | 9.9900 | 10.0000 | 10.0100 | |
| | | MAX6043C (0.5%) | 9.9500 | 10.0000 | 10.0500 | |
| Output-Voltage Temperature Coefficient (Note 2) | $T_A = -40^\circ C$ to $+125^\circ C$ | MAX6043A_10 | | 3 | 15 | ppm/ $^\circ C$ |
| | | MAX6043B_10 | | 5 | 25 | |
| | | MAX6043C_10 | | 10 | 65 | |
| Line Regulation (Note 4) | $12V \leq V_{IN} \leq 40V$ | $T_A = +25^\circ C$ | | 1 | 6 | ppm/V |
| | | $T_A = -40^\circ C$ to $+125^\circ C$ | | 1.5 | 10 | |
| Load Regulation (Note 4) | Sourcing, $0 \leq I_{OUT} \leq 10mA$ | $T_A = +25^\circ C$ | | 16 | 70 | ppm/mA |
| | | $T_A = -40^\circ C$ to $+125^\circ C$ | | | 70 | |
| | Sinking, $-0.6mA \leq I_{OUT} \leq 0mA$ | $T_A = +25^\circ C$ | | 170 | 900 | |
| | | $T_A = -40^\circ C$ to $+125^\circ C$ | | | 900 | |
| OUT Short-Circuit Current | OUT shorted to GND | | | 60 | | mA |
| | OUT shorted to IN | | | -2 | | |
| Thermal Hysteresis | (Note 3) | | | 150 | | ppm |
| Long-Term Stability | $\Delta t = 1000hr$ | | | 150 | | ppm |
| DYNAMIC CHARACTERISTICS | | | | | | |
| Output Noise Voltage | 0.1Hz to 10Hz | | | 19 | | μV_{P-P} |
| | 10Hz to 1kHz | | | 30 | | μV_{RMS} |
| Turn-On Settling Time | To $V_{OUT} = 0.05\%$ of final value, $C_{OUT} = 50pF$ | | | 390 | | μs |
| INPUT | | | | | | |
| Supply Voltage Range | Inferred from line regulation test | | 12.0 | | 40.0 | V |
| Quiescent Supply Current | $I_{OUT} = 0$ | $T_A = +25^\circ C$ | | 320 | 490 | μA |
| | | $T_A = -40^\circ C$ to $+125^\circ C$ | | 390 | 650 | |

Note 1: All devices are 100% production tested at $T_A = +25^\circ C$ and guaranteed by design over $T_A = T_{MIN}$ to T_{MAX} as specified.

Note 2: Temperature coefficient is defined as ΔV_{OUT} divided by the temperature range.

Note 3: Thermal hysteresis defined as the change in output voltage at $T_A = +25^\circ C$ before and after cycling the device from T_{MAX} to T_{MIN} .

Note 4: Line and load regulation do not include the effect of self heating.

Typical Operating Characteristics

($V_{IN} = +5V$ for $V_{OUT} = +2.5V$, $V_{IN} = +10V$ for $V_{OUT} = +3.3V$ or $+4.096V$, $V_{IN} = +15V$ for $V_{OUT} = +5V$ or $+10V$, $I_{OUT} = 0$, $T_A = +25^\circ C$, unless otherwise noted.)

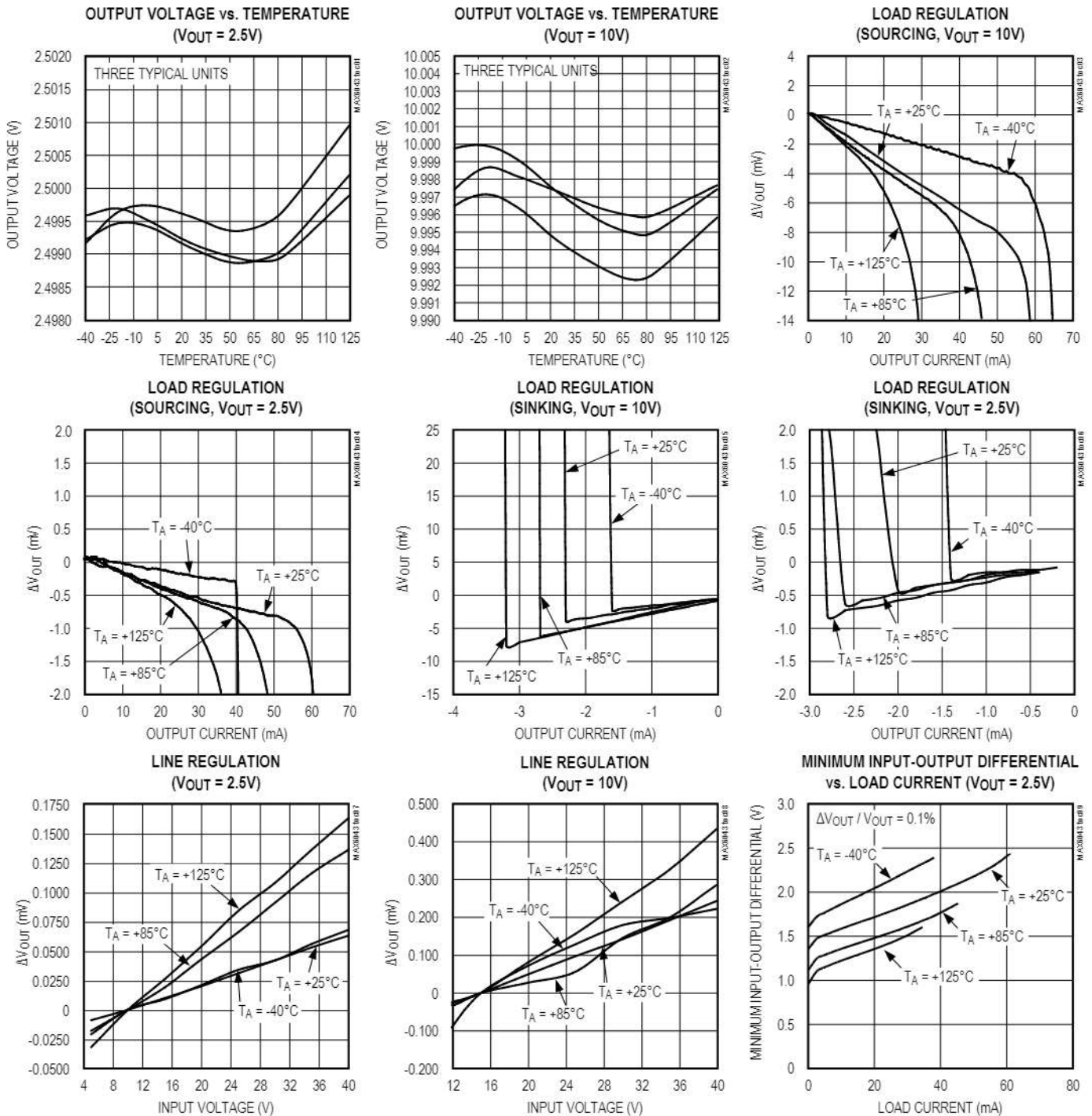

Typical Operating Characteristics (continued)

($V_{IN} = +5V$ for $V_{OUT} = +2.5V$, $V_{IN} = +10V$ for $V_{OUT} = +3.3V$ or $+4.096V$, $V_{IN} = +15V$ for $V_{OUT} = +5V$ or $+10V$, $I_{OUT} = 0$, $T_A = +25^\circ C$, unless otherwise noted.)

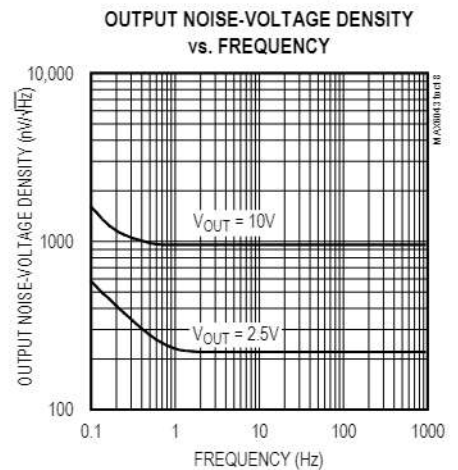
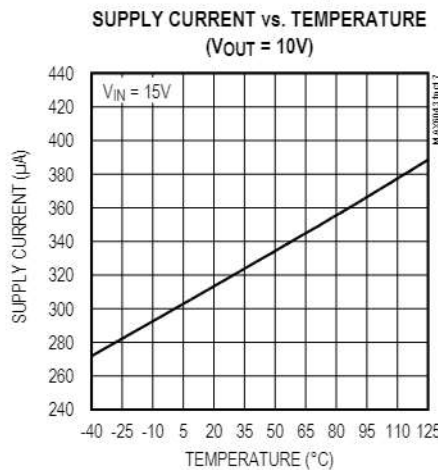
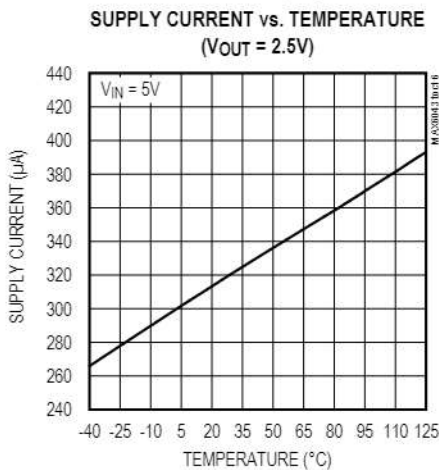
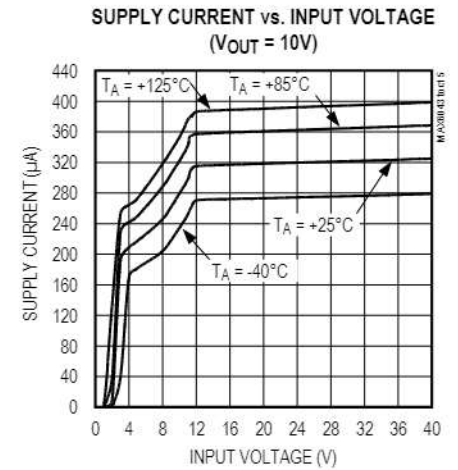
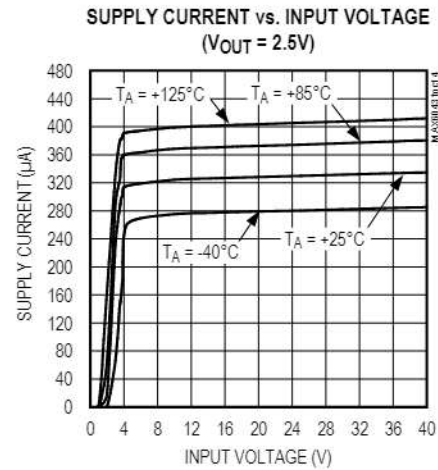
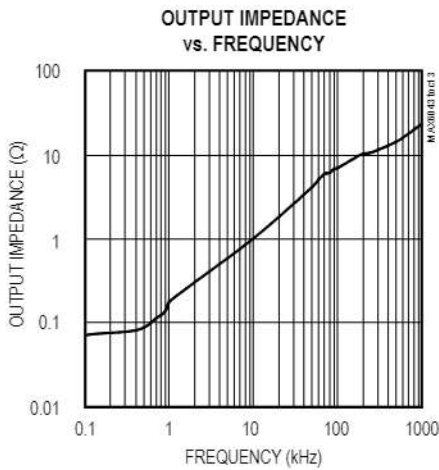
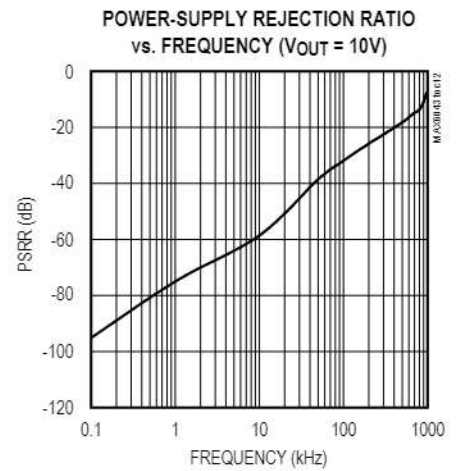
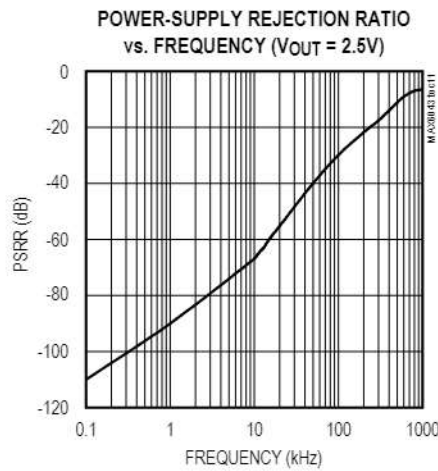
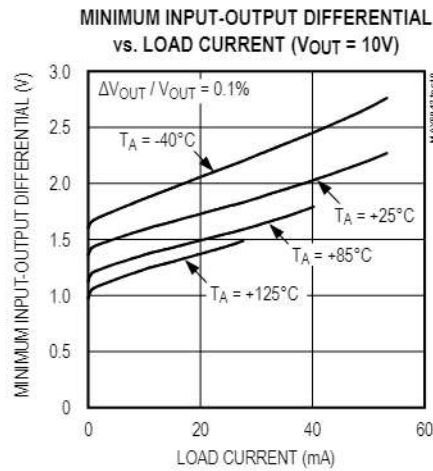

Typical Operating Characteristics (continued)

($V_{IN} = +5V$ for $V_{OUT} = +2.5V$, $V_{IN} = +10V$ for $V_{OUT} = +3.3V$ or $+4.096V$, $V_{IN} = +15V$ for $V_{OUT} = +5V$ or $+10V$, $I_{OUT} = 0$, $T_A = +25^\circ C$, unless otherwise noted.)

0.1Hz TO 10Hz OUTPUT NOISE
($V_{OUT} = 2.5V$)

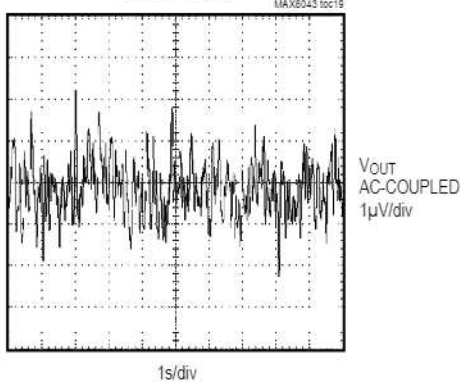

0.1Hz TO 10Hz OUTPUT NOISE
($V_{OUT} = 10V$)

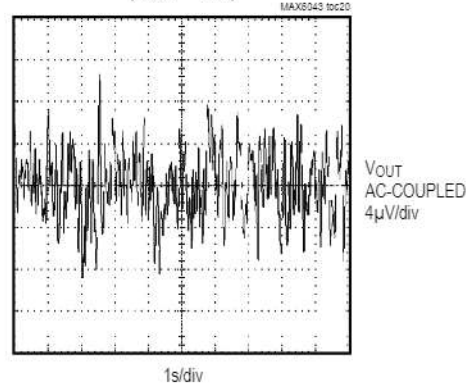

LOAD TRANSIENT
($V_{OUT} = 2.5V$)

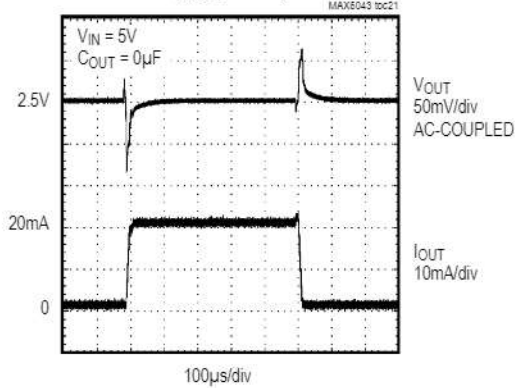

LOAD TRANSIENT
($V_{OUT} = 10V$)

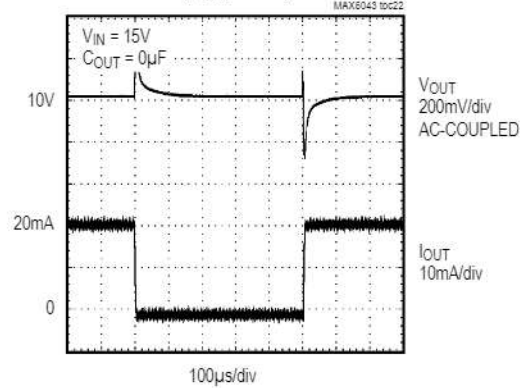

LOAD TRANSIENT
($V_{OUT} = 2.5V$)

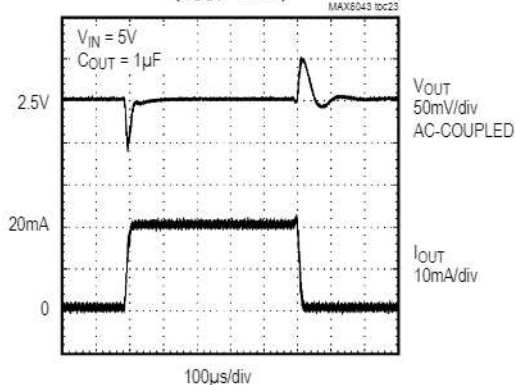

LOAD TRANSIENT
($V_{OUT} = 10V$)

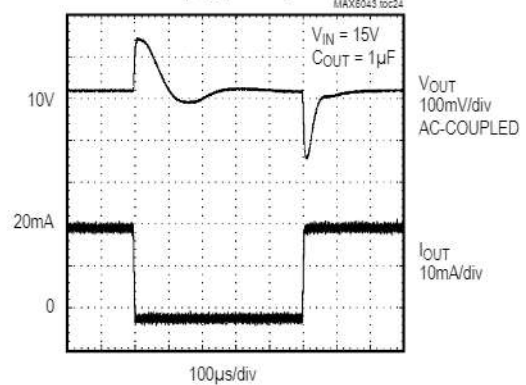

Typical Operating Characteristics (continued)

($V_{IN} = +5V$ for $V_{OUT} = +2.5V$, $V_{IN} = +10V$ for $V_{OUT} = +3.3V$ or $+4.096V$, $V_{IN} = +15V$ for $V_{OUT} = +5V$ or $+10V$, $I_{OUT} = 0$, $T_A = +25^\circ C$, unless otherwise noted.)

LOAD TRANSIENT
($V_{OUT} = 2.5V$)

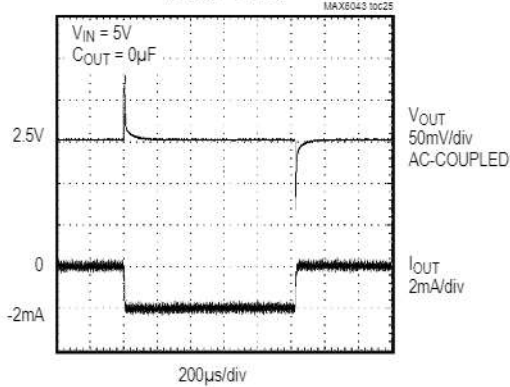

LOAD TRANSIENT
($V_{OUT} = 10V$)

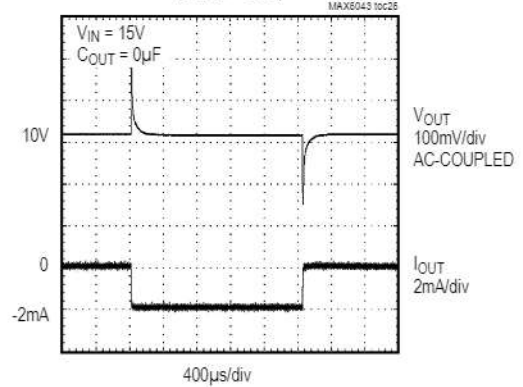

LOAD TRANSIENT
($V_{OUT} = 2.5V$)

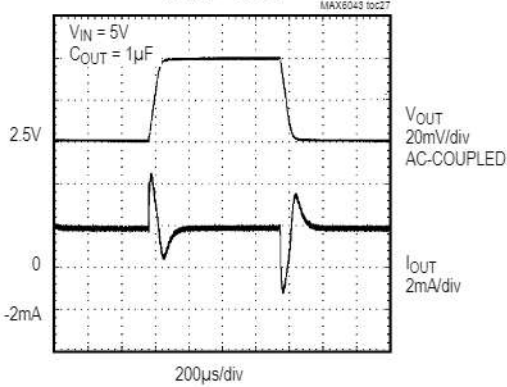

LOAD TRANSIENT
($V_{OUT} = 10V$)

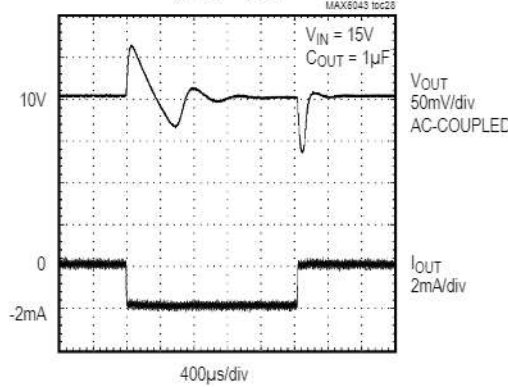

LINE TRANSIENT
($V_{OUT} = 2.5V$)

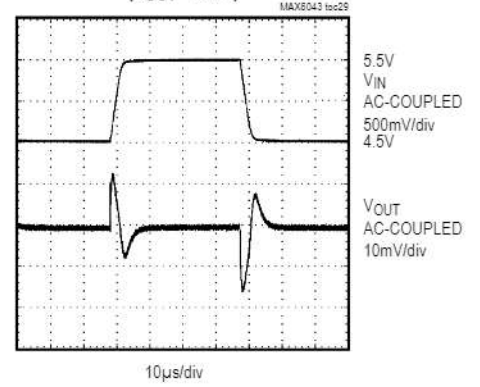

LINE TRANSIENT
($V_{OUT} = 10V$)

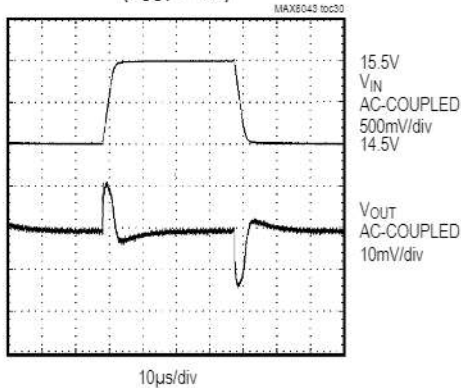

TURN-ON TRANSIENT
($V_{OUT} = 2.5V$)

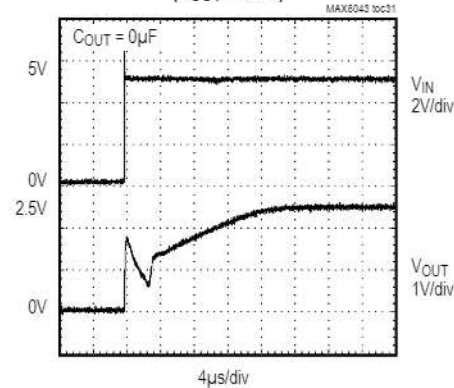

TURN-ON TRANSIENT
($V_{OUT} = 10V$)

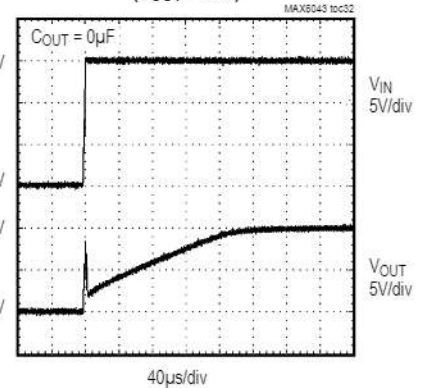

Typical Operating Characteristics (continued)

($V_{IN} = +5V$ for $V_{OUT} = +2.5V$, $V_{IN} = +10V$ for $V_{OUT} = +3.3V$ or $+4.096V$, $V_{IN} = +15V$ for $V_{OUT} = +5V$ or $+10V$, $I_{OUT} = 0$, $T_A = +25^\circ C$, unless otherwise noted.)

**TURN-ON TRANSIENT
($V_{OUT} = 2.5V$)**

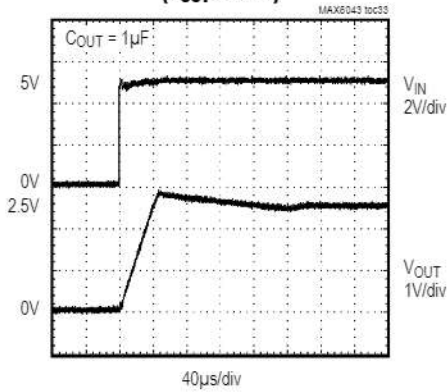

**TURN-ON TRANSIENT
($V_{OUT} = 10V$)**

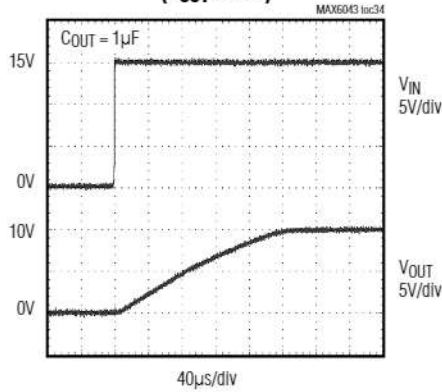

**TURN-OFF TRANSIENT
($V_{OUT} = 2.5V$)**

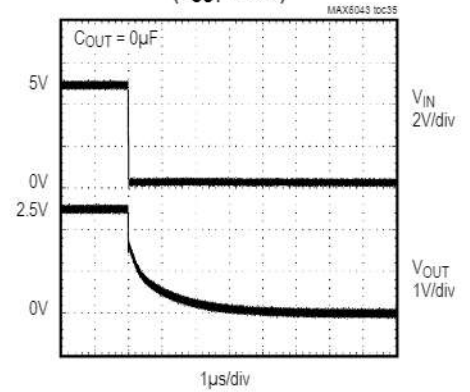

**TURN-OFF TRANSIENT
($V_{OUT} = 10V$)**

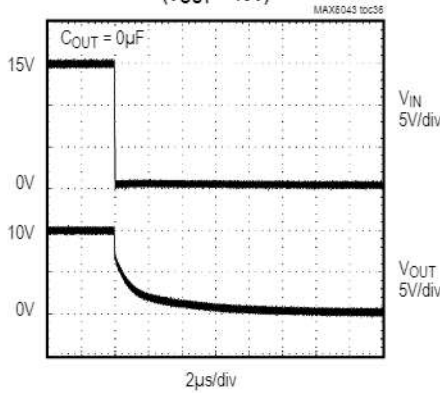

**TURN-OFF TRANSIENT
($V_{OUT} = 2.5V$)**

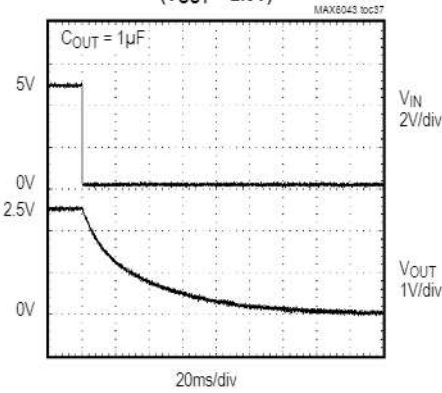

TURN-OFF TRANSIENT

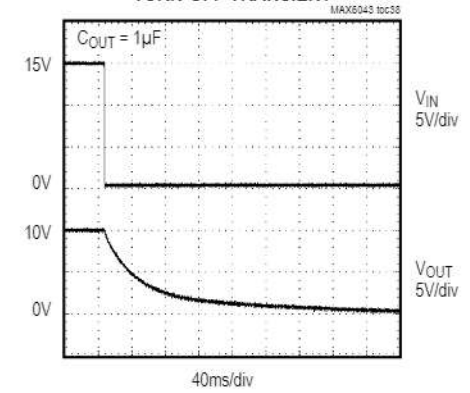

**LONG-TERM DRIFT
($V_{OUT} = 2.5V$)**

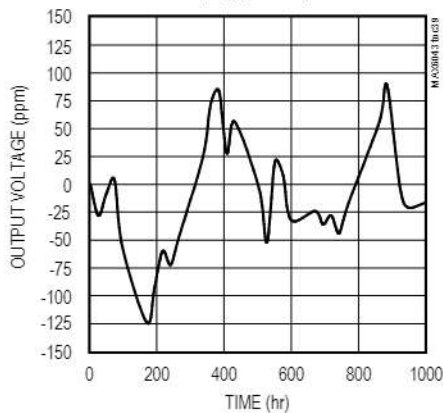

**LONG-TERM DRIFT
($V_{OUT} = 10V$)**

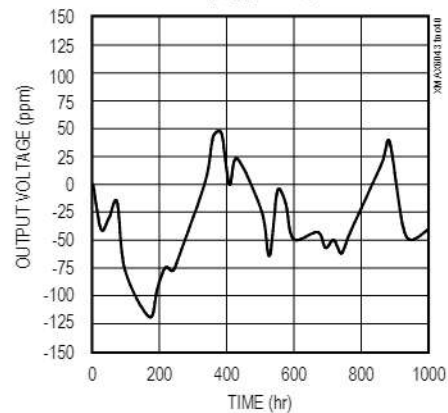

Pin Description

| PIN | NAME | FUNCTION |
|------|------|---|
| 1, 3 | I.C. | Internally Connected. Do not connect externally. |
| 2 | GND | Ground |
| 4 | IN | Positive Power-Supply Input |
| 5 | OUTF | Voltage-Reference Force Output. Connect OUTF to OUTS as close to the device as possible. OUTF and OUTS do not require a bypass capacitor for stability. |
| 6 | OUTS | Voltage-Reference Sense Input |

Applications Information

Bypassing/Output Capacitance

For the best line-transient performance, decouple the input with a 0.1 μ F ceramic capacitor as shown in the *Typical Operating Circuit*. Place the capacitor as close to IN as possible. When transient performance is less important, no capacitor is necessary.

The MAX6043 does not require an output capacitor for stability and is stable with capacitive loads up to 100 μ F. In applications where the load or the supply can experience step changes, a larger output capacitor reduces the amount of overshoot (undershoot) and improves the circuit's transient response. Place output capacitors as close to the device as possible for best performance.

Supply Current

The MAX6043 consumes 320 μ A of quiescent supply current. This improved efficiency reduces power dissipation and extends battery life.

Thermal Hysteresis

Thermal hysteresis is the change in the output voltage at $T_A = +25^\circ\text{C}$ before and after the device is cycled over its entire operating temperature range. Hysteresis is caused by differential package stress appearing across the band-gap core transistors. The typical thermal hysteresis value is 150ppm.

Turn-On Time

The MAX6043 typically turns on and settles to within 0.05% of the preset output voltage in 150 μ s.

Short-Circuited Outputs

The MAX6043 features a short-circuit-protected output. Internal circuitry limits the output current to 60mA when short-circuiting the output.

Temperature Coefficient vs. Operating Temperature Range for a 1 LSB Maximum Error

In a data converter application, the reference voltage of the converter must stay within a certain limit to keep the error in the data converter smaller than the resolution limit through the operating temperature range. Figure 1 shows the maximum allowable reference-voltage temperature coefficient to keep the conversion error to less than 1 LSB, as a function of the operating temperature range ($T_{MAX} - T_{MIN}$) with the converter resolution as a parameter. The graph assumes the reference-voltage temperature coefficient as the only parameter affecting accuracy.

In reality, the absolute static accuracy of a data converter is dependent on the combination of many parameters such as integral nonlinearity, differential nonlinearity, offset error, gain error, as well as voltage-reference changes.

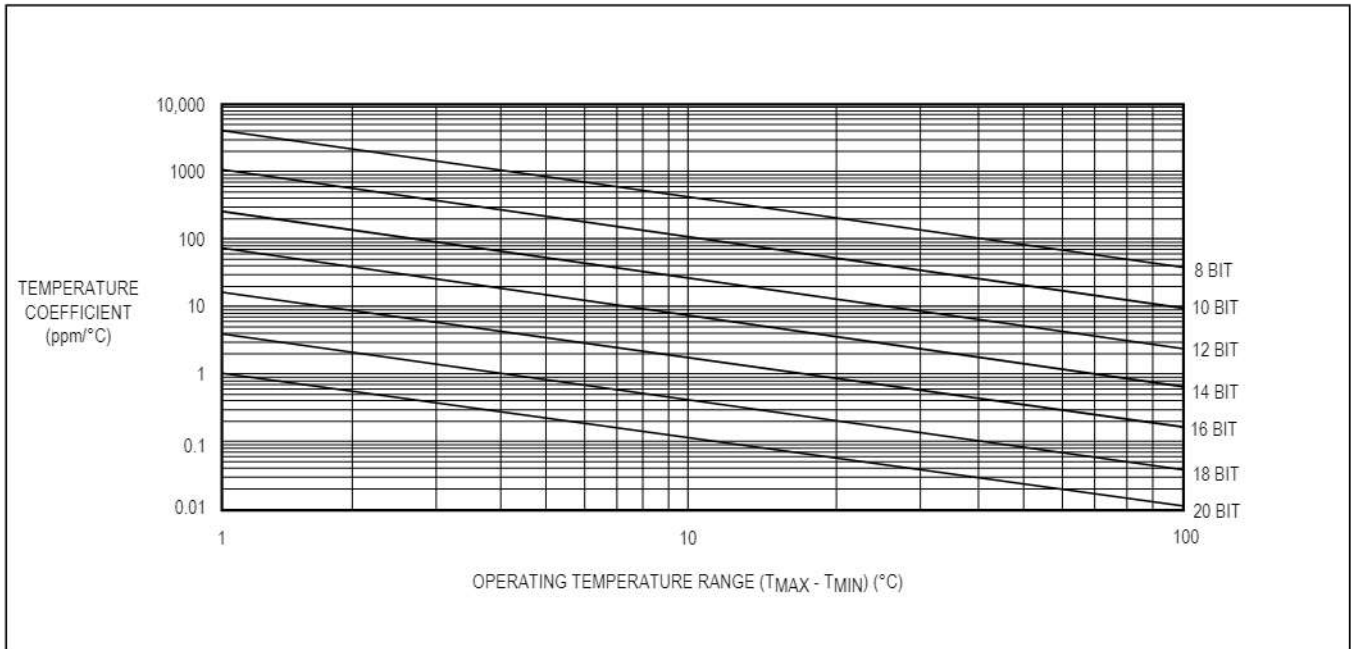
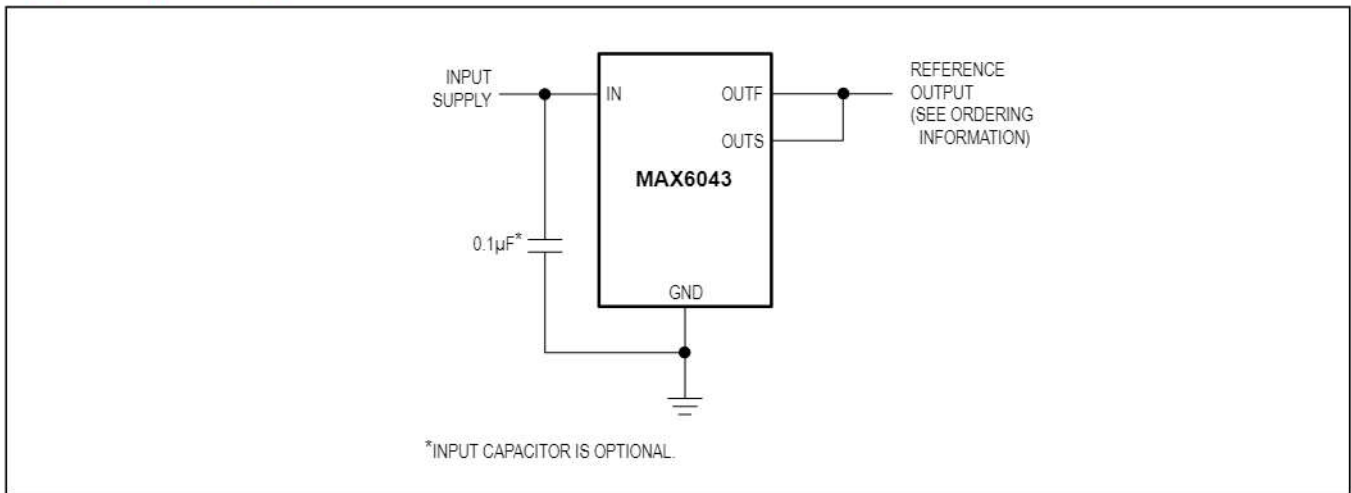

Figure 1. Temperature Coefficient vs. Operating Temperature Range for a 1 LSB Maximum Error

Typical Operating Circuit



Ordering Information (continued)

| PART | OUTPUT VOLTAGE (V) | TEMPCO (PPM/°C) | INITIAL ACCURACY (%) | TOP MARK |
|--------------------|--------------------|-----------------|----------------------|----------|
| MAX6043CAUT33#TG16 | 3.300 | 65 | 0.50 | #ACMM |
| MAX6043AAUT41-T | 4.096 | 15 | 0.06 | ABSB |
| MAX6043AAUT41#TG16 | 4.096 | 15 | 0.06 | #ACMN |
| MAX6043BAUT41-T | 4.096 | 20 | 0.10 | ABDU |
| MAX6043BAUT41#TG16 | 4.096 | 20 | 0.10 | #ACMO |
| MAX6043CAUT41-T | 4.096 | 65 | 0.50 | ABDV |
| MAX6043CAUT41#TG16 | 4.096 | 65 | 0.50 | #ACMP |
| MAX6043AAUT50-T | 5.000 | 15 | 0.06 | ABSC |
| MAX6043AAUT50#TG16 | 5.000 | 15 | 0.06 | #ACMQ |
| MAX6043BAUT50-T | 5.000 | 20 | 0.10 | ABDW |
| MAX6043BAUT50#TG16 | 5.000 | 20 | 0.10 | #ACMR |
| MAX6043CAUT50-T | 5.000 | 65 | 0.50 | ABDX |
| MAX6043CAUT50#TG16 | 5.000 | 65 | 0.50 | #ACMS |
| MAX6043AAUT10-T | 10.000 | 15 | 0.06 | ABSD |
| MAX6043AAUT10#TG16 | 10.000 | 15 | 0.06 | #ACMT |
| MAX6043BAUT10-T | 10.000 | 20 | 0.10 | ABDY |
| MAX6043BAUT10#TG16 | 10.000 | 20 | 0.10 | #ACMU |
| MAX6043CAUT10-T | 10.000 | 65 | 0.50 | ABDZ |
| MAX6043CAUT10#TG16 | 10.000 | 65 | 0.50 | #ACMV |
| MAX6043BAUT25+T | 2.500 | 20 | 0.10 | +ABDQ |
| MAX6043BAUT33+T | 3.300 | 20 | 0.10 | +ABDS |
| MAX6043BAUT41+T | 4.096 | 20 | 0.10 | +ABDU |
| MAX6043BAUT50+T | 5.000 | 20 | 0.10 | +ABDW |
| MAX6043BAUT10+T | 10.000 | 20 | 0.10 | +ABDY |
| MAX6043CAUT25+T | 2.500 | 65 | 0.50 | +ABDR |
| MAX6043CAUT33+T | 3.300 | 65 | 0.50 | +ABDT |
| MAX6043CAUT41+T | 4.096 | 65 | 0.50 | +ABDV |
| MAX6043CAUT50+T | 5.000 | 65 | 0.50 | +ABDX |
| MAX6043CAUT10+T | 10.000 | 65 | 0.50 | +ABDZ |

#Denotes an RoHS-compliant device that may include lead that is exempt under the RoHS requirements.

T = Tape and reel.

Chip Information

PROCESS: BICMOS

Revision History

| REVISION NUMBER | REVISION DATE | DESCRIPTION | PAGES CHANGED |
|-----------------|---------------|---|---------------|
| 0 | 11/03 | Initial release | — |
| 1 | 5/04 | Added future product information, updated the <i>Electrical Characteristics</i> and <i>Typical Operating Characteristics</i> . | 1–6, 11, 12 |
| 2 | 8/12 | Updated the <i>Ordering Information/Selector Guide</i> , <i>Absolute Maximum Ratings</i> , and the <i>Package Information</i> sections. | 1, 14, 15 |
| 3 | 1/19 | Updated <i>Ordering Information</i> , <i>Absolute Maximum Ratings</i> , added <i>Package Information</i> section, | 1, 2, 14 |
| 4 | 3/19 | Updated <i>Ordering Information</i> | 15 |

For pricing, delivery, and ordering information, please visit Maxim Integrated's online storefront at <https://www.maximintegrated.com/en/storefront/storefront.html>.

Maxim Integrated cannot assume responsibility for use of any circuitry other than circuitry entirely embodied in a Maxim Integrated product. No circuit patent licenses are implied. Maxim Integrated reserves the right to change the circuitry and specifications without notice at any time. The parametric values (min and max limits) shown in the *Electrical Characteristics* table are guaranteed. Other parametric values quoted in this data sheet are provided for guidance.

Looking for pricing, stock, or lifecycle information?

Click below to explore more details on WIN SOURCE:

 [View **EEE-FP1E101AL** on WIN SOURCE](#)

 [Panasonic Information](#)

Optimize Your Supply Chain with WIN SOURCE Solutions

-  Global Sourcing Solution
-  Obsolete Management
-  Cost Control Management
-  Shortage Management
-  Alternative Solution
-  Excess Inventory Management