



**THE DATASHEET OF
C0603B106M007T**





BZX58550 series

Low-current voltage regulator diodes

Rev. 3 — 26 July 2024

Product data sheet

1. General description

Low-current voltage regulator diodes in an SOD523 (SC-79) ultra small and flat lead Surface-Mounted Device (SMD) plastic package.

2. Features and benefits

- Total power dissipation: ≤ 300 mW
- Two tolerance series: $\pm 2\%$ and approximately $\pm 5\%$
- Working voltage range: nominal 1.8 V to 51 V
- Specified at a low test current (50 μ A), ideal for low bias and portable battery-powered applications
- BZX58550-B11 to -C51: Intentional minor rise of leakage current for optimized fast switching and noise reduction [[AN90031](#)]

3. Applications

- Low-current general regulation functions

4. Quick reference data

Table 1. Quick reference data

Symbol	Parameter	Conditions	Min	Typ	Max	Unit
V_F	forward voltage	$I_F = 10$ mA [1]	-	-	0.9	V
P_{tot}	total power dissipation	$T_{amb} \leq 25$ °C [2]	-	-	300	mW

[1] Pulse test: $t_p \leq 300$ μ s; $\delta \leq 0.02$

[2] Device mounted on an FR4 Printed-Circuit Board (PCB), with approximately 35 mm² Cu area at cathode tab.

5. Pinning information

Table 2. Pinning

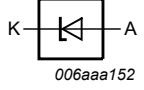
Pin	Symbol	Description	Simplified outline	Graphic symbol
1	K	cathode[1]		
2	A	anode		

[1] The marking bar indicates the cathode.

6. Ordering information

Table 3. Ordering information

Type number	Package		
	Name	Description	Version
BZX58550 series	SC-79	plastic, surface-mounted package; 2 leads; 1.2 mm x 0.8 mm x 0.6 mm body	SOD523

7. Marking

Table 4. Marking Codes

Type number	Marking code	Type number	Marking code	Type number	Marking code	Type number	Marking code
BZX58550-B1V8	4H	BZX58550-B10	5T	BZX58550-C1V8	1C	BZX58550-C10	2L
BZX58550-B2V0	4K	BZX58550-B11	5U	BZX58550-C2V0	1E	BZX58550-C11	2N
BZX58550-B2V2	4L	BZX58550-B12	5X	BZX58550-C2V2	1F	BZX58550-C12	2S
BZX58550-B2V4	4N	BZX58550-B13	5Y	BZX58550-C2V4	1H	BZX58550-C13	2T
BZX58550-B2V7	4S	BZX58550-B15	5Z	BZX58550-C2V7	1K	BZX58550-C15	2U
BZX58550-B3V0	4T	BZX58550-B16	6C	BZX58550-C3V0	1L	BZX58550-C16	2X
BZX58550-B3V3	4U	BZX58550-B18	6E	BZX58550-C3V3	1N	BZX58550-C18	2Y
BZX58550-B3V6	4X	BZX58550-B20	6F	BZX58550-C3V6	1S	BZX58550-C20	3C
BZX58550-B3V9	4Y	BZX58550-B22	6H	BZX58550-C3V9	1T	BZX58550-C22	3E
BZX58550-B4V3	4Z	BZX58550-B24	6K	BZX58550-C4V3	1U	BZX58550-C24	3F
BZX58550-B4V7	5C	BZX58550-B27	6L	BZX58550-C4V7	1X	BZX58550-C27	3H
BZX58550-B5V1	5E	BZX58550-B30	6N	BZX58550-C5V1	1Y	BZX58550-C30	3K
BZX58550-B5V6	5F	BZX58550-B33	6S	BZX58550-C5V6	1Z	BZX58550-C33	3L
BZX58550-B6V2	5H	BZX58550-B36	6T	BZX58550-C6V2	2C	BZX58550-C36	3N
BZX58550-B6V8	5K	BZX58550-B39	6U	BZX58550-C6V8	2E	BZX58550-C39	3S
BZX58550-B7V5	5L	BZX58550-B43	6X	BZX58550-C7V5	2F	BZX58550-C43	3T
BZX58550-B8V2	5N	BZX58550-B47	6Y	BZX58550-C8V2	2H	BZX58550-C47	3U
BZX58550-B9V1	5S	BZX58550-B51	6Z	BZX58550-C9V1	2K	BZX58550-C51	3X

8. Limiting values

Table 5. Limiting values

In accordance with the Absolute Maximum Rating System (IEC 60134).

Symbol	Parameter	Conditions	Min	Max	Unit	
I_F	forward current		-	200	mA	
P_{ZSM}	non-repetitive peak reverse power dissipation	$t_p = 100 \mu\text{s}$; square wave; $T_j = 25 \text{ }^\circ\text{C}$; prior to surge	-	40	W	
P_{tot}	total power dissipation	$T_{amb} \leq 25 \text{ }^\circ\text{C}$	[1]	-	270	mW
			[2]	-	300	mW
			[3]	-	440	mW
T_j	junction temperature		-	150	$^\circ\text{C}$	
T_{amb}	ambient temperature		-55	+150	$^\circ\text{C}$	
T_{stg}	storage temperature		-65	+150	$^\circ\text{C}$	

[1] Device mounted on an FR4 Printed-Circuit Board (PCB), single-sided copper, tin-plated and standard footprint.

[2] Device mounted on an FR4 PCB, with approximately 35 mm² Cu area at cathode tab.

[3] Device mounted on an FR4 PCB, single-sided copper, tin-plated, mounting pad for cathode 1 cm².

9. Thermal characteristics

Table 6. Thermal characteristics

Symbol	Parameter	Conditions	Min	Typ	Max	Unit	
$R_{th(j-a)}$	thermal resistance from junction to ambient	in free air	[1]	-	-	460	K/W
			[2]	-	-	350	K/W
			[3]	-	-	285	K/W
$R_{th(j-sp)}$	thermal resistance from junction to solder point		[4]	-	-	65	K/W

[1] Device mounted on an FR4 PCB, single-sided copper, tin-plated and standard footprint.

[2] Device mounted on an FR4 PCB, with approximately 35 mm² Cu area at cathode tab.

[3] Device mounted on an FR4 PCB, single-sided copper, tin-plated, mounting pad for cathode 1 cm².

[4] Soldering point of cathode tab

10. Characteristics

Table 7. Electrical characteristics

$T_j = 25 \text{ }^\circ\text{C}$ unless otherwise specified.

Symbol	Parameter	Conditions	Max	Unit	
V_F	forward voltage	$I_F = 10 \text{ mA}$	[1]	0.9	V

[1] Pulse test: $t_p \leq 300 \mu\text{s}$; $\delta \leq 0.02$

Table 8. Electrical characteristics per type: BZX58550-B1V8 to BZX58550-C36

 $T_j = 25\text{ °C}$ unless otherwise specified.

BZX58550-xxx	Sel.	Working voltage V_Z (V)		Differential resistance r_{diff} (Ω)		Reverse current I_R (μ A)		Temperature coefficient S_Z (mV/K)		Diode capacitance C_d (pF)
		$I_Z = 50\ \mu$ A		$I_Z = 1$ mA	$I_Z = 5$ mA	Max	V_R (V)	$I_Z = 5$ mA		$f = 1$ MHz $V_R = 0$ V
		Min	Max	Max	Max			Min	Max	Max
1V8	B	1.76	1.84	600	100	7.5	1.0	-3.5	0	220
	C	1.71	1.89							
2V0	B	1.96	2.04	600	100	7	1.0	-3.5	0	220
	C	1.88	2.12							
2V2	B	2.15	2.25	600	100	4	1.0	-3.5	0	210
	C	2.09	2.31							
2V4	B	2.35	2.45	600	100	2	1.0	-3.5	0	200
	C	2.28	2.52							
2V7	B	2.65	2.75	600	100	1	1.0	-3.5	0	190
	C	2.565	2.835							
3V0	B	2.94	3.06	600	100	0.8	1.0	-3.5	0.2	170
	C	2.85	3.15							
3V3	B	3.23	3.37	600	100	7.5	1.5	-3.5	1.2	160
	C	3.13	3.47							
3V6	B	3.53	3.67	600	95	7.5	2.0	-3.5	1.2	160
	C	3.42	3.78							
3V9	B	3.82	3.98	600	95	5.0	2.0	-2.7	2.5	150
	C	3.70	4.10							
4V3	B	4.21	4.39	600	95	4.0	2.0	-2.7	2.5	150
	C	4.09	4.52							
4V7	B	4.61	4.79	600	80	5.0	3.0	-2.7	2.5	140
	C	4.47	4.94							
5V1	B	5.00	5.20	500	60	5.0	3.0	-2.0	3.7	130
	C	4.85	5.36							
5V6	B	5.49	5.71	400	40	2.0	4.0	-2.0	3.7	120
	C	5.32	5.88							
6V2	B	6.08	6.32	160	10	1.0	5.0	0.4	4.5	110
	C	5.89	6.51							
6V8	B	6.66	6.94	80	15	0.1	5.1	1.2	4.5	100
	C	6.46	7.14							
7V5	B	7.35	7.65	80	15	0.1	5.7	2.5	5.3	150
	C	7.13	7.88							
8V2	B	8.04	8.36	80	15	0.1	6.2	3.2	6.2	150
	C	7.79	8.61							
9V1	B	8.92	9.28	100	15	0.1	6.9	3.8	7.0	150
	C	8.65	9.56							
10	B	9.80	10.20	150	20	0.1	7.6	4.5	8.0	90
	C	9.50	10.50							

BZX58550-xxx	Sel.	Working voltage V_Z (V)		Differential resistance r_{diff} (Ω)		Reverse current I_R (μ A)		Temperature coefficient S_Z (mV/K)		Diode capacitance C_d (pF)
		$I_Z = 50 \mu$ A		$I_Z = 1$ mA	$I_Z = 5$ mA	Max	V_R (V)	$I_Z = 5$ mA		$f = 1$ MHz $V_R = 0$ V
		Min	Max	Max	Max			Min	Max	Max
11	B	10.80	11.20	150	20	0.05	8.4	5.4	9.0	85
	C	10.45	11.55							
12	B	11.80	12.20	150	25	0.05	9.1	6.0	10	85
	C	11.40	12.60							
13	B	12.70	13.30	170	30	0.05	9.8	7.0	11	80
	C	12.35	13.65							
15	B	14.70	15.30	200	30	0.05	11.4	9.2	13	75
	C	14.25	15.75							
16	B	15.70	16.30	200	40	0.05	12.1	10.4	14	75
	C	15.20	16.80							
18	B	17.60	18.40	225	45	0.05	13.6	12.4	16	70
	C	17.10	18.90							
20	B	19.60	20.40	225	55	0.05	15.2	14.4	18	60
	C	19.00	21.00							
22	B	21.60	22.40	250	55	0.05	16.7	16.4	20	60
	C	20.90	23.10							
24	B	23.50	24.50	250	70	0.05	18.2	18.4	22	55
	C	22.80	25.20							
27	B	26.50	27.50	300	80	0.05	20.4	21.4	25.3	50
	C	25.65	28.35							
30	B	29.40	30.60	300	80	0.05	22.8	24.4	29.4	50
	C	28.50	31.50							
33	B	32.30	33.70	325	80	0.05	25.0	27.4	33.4	45
	C	31.35	34.65							
36	B	35.30	36.70	350	90	0.05	27.3	30.4	37.4	45
	C	34.20	37.80							

Table 9. Electrical characteristics per type: BZX58550-B39 to BZX58550-C51

$T_j = 25\text{ °C}$ unless otherwise specified.

BZX58550-xxx	Sel.	Working voltage V_Z (V)		Differential resistance r_{diff} (Ω)		Reverse current I_R (μA)		Temperature coefficient S_Z (mV/K)		Diode capacitance C_d (pF)
		$I_Z = 50\ \mu\text{A}$		$I_Z = 0.5\ \text{mA}$	$I_Z = 2\ \text{mA}$	Max	V_R (V)	$I_Z = 2\ \text{mA}$		$f = 1\ \text{MHz}$ $V_R = 0\ \text{V}$
		Min	Max	Max	Max			Min	Max	Max
39	B	38.20	39.80	350	130	0.05	29.6	33.4	41.2	45
	C	37.05	40.95							
43	B	42.10	43.90	375	150	0.05	32.6	37.6	46.6	40
	C	40.85	45.15							
47	B	46.10	47.90	375	170	0.05	32.9	42.0	51.8	40
	C	44.00	50.00							
51	B	50.00	52.00	400	180	0.05	35.7	46.6	57.2	40
	C	48.00	54.00							

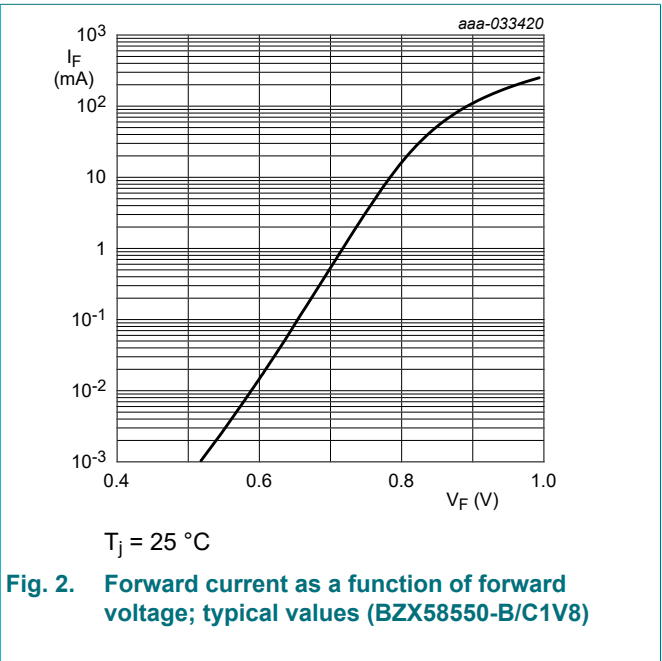
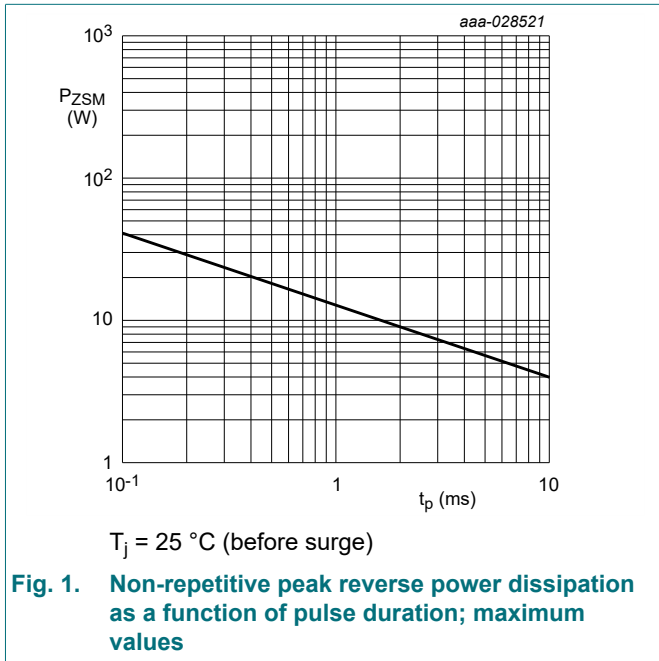

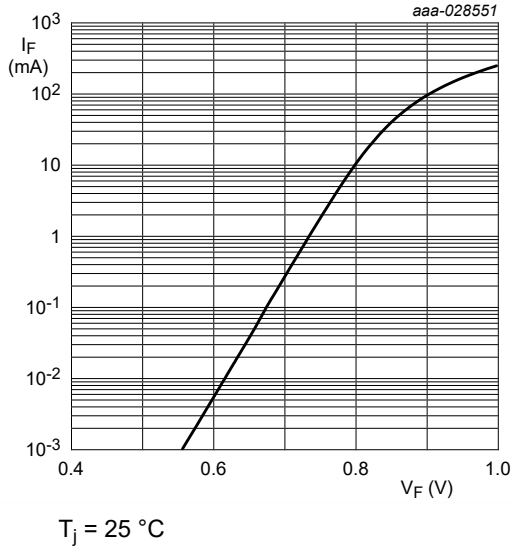

Fig. 3. Forward current as a function of forward voltage; typical values (BZX58550-B/C6V8)

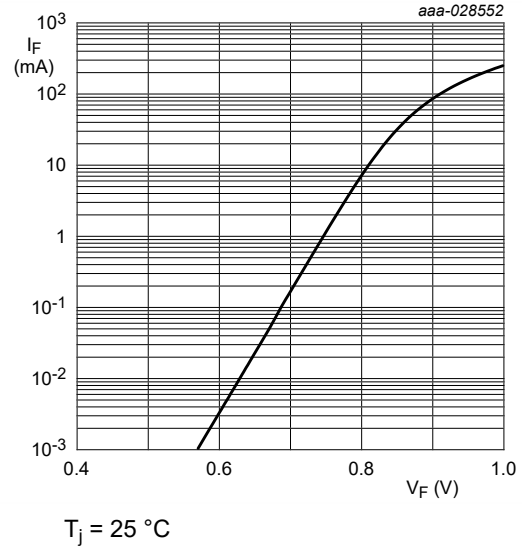

Fig. 4. Forward current as a function of forward voltage; typical values (BZX58550-B/C7V5)

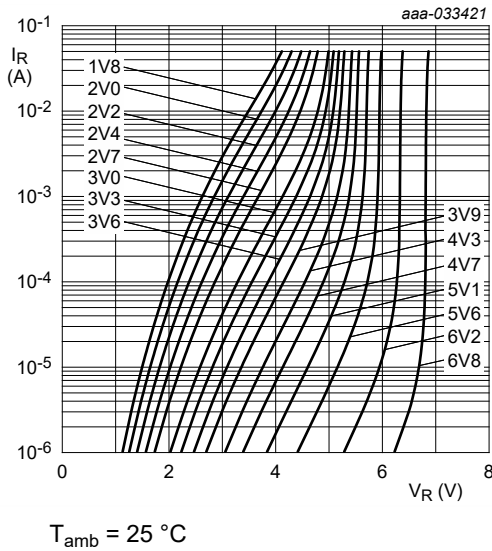

Fig. 5. Reverse current as a function of reverse voltage; typical values (BZX58550-B/C1V8 to BZX58550-B/C6V8)

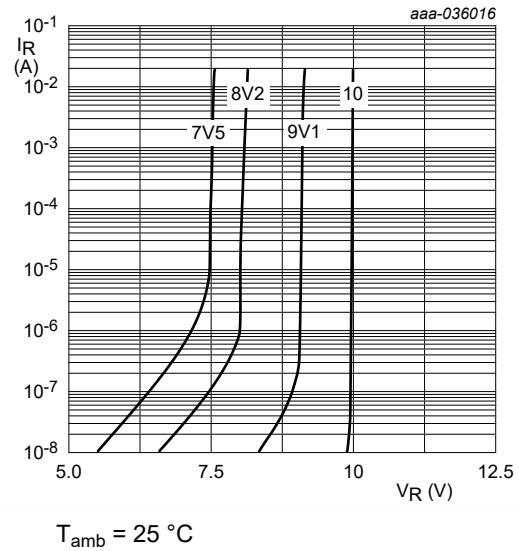
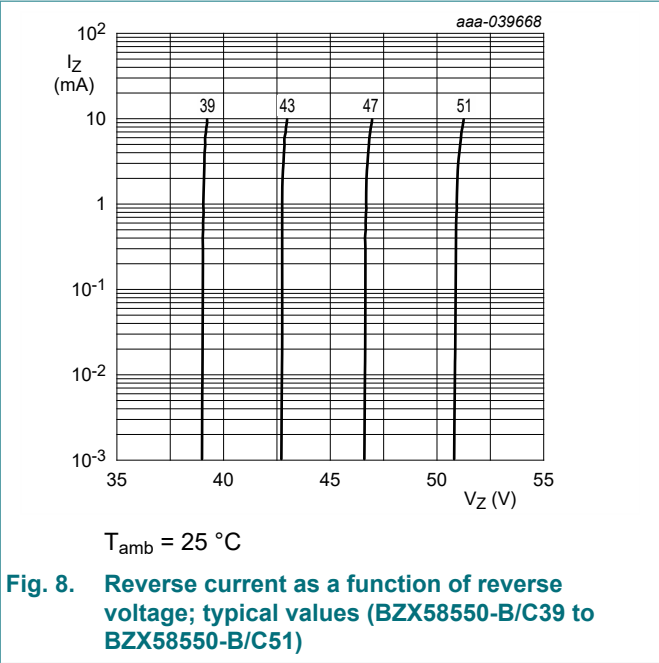
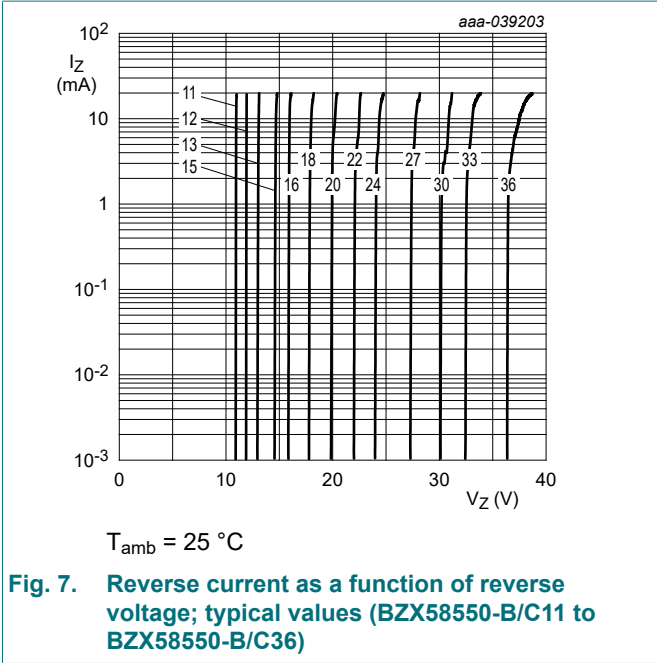
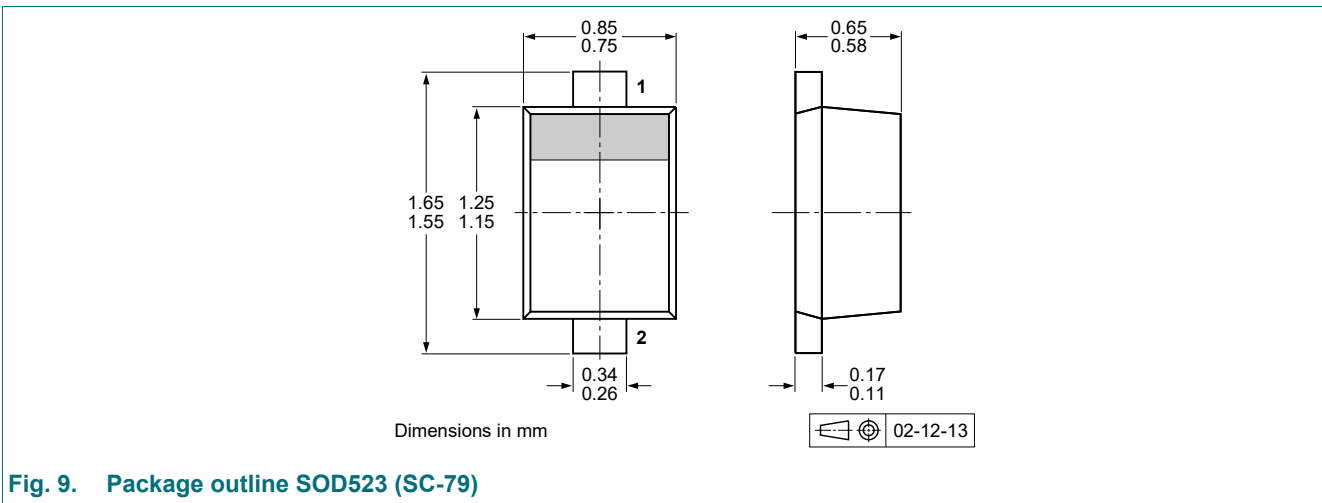

Fig. 6. Reverse current as a function of reverse voltage; typical values (BZX58550-B/C7V5 to BZX58550-B/C10)



11. Package outline



12. Soldering

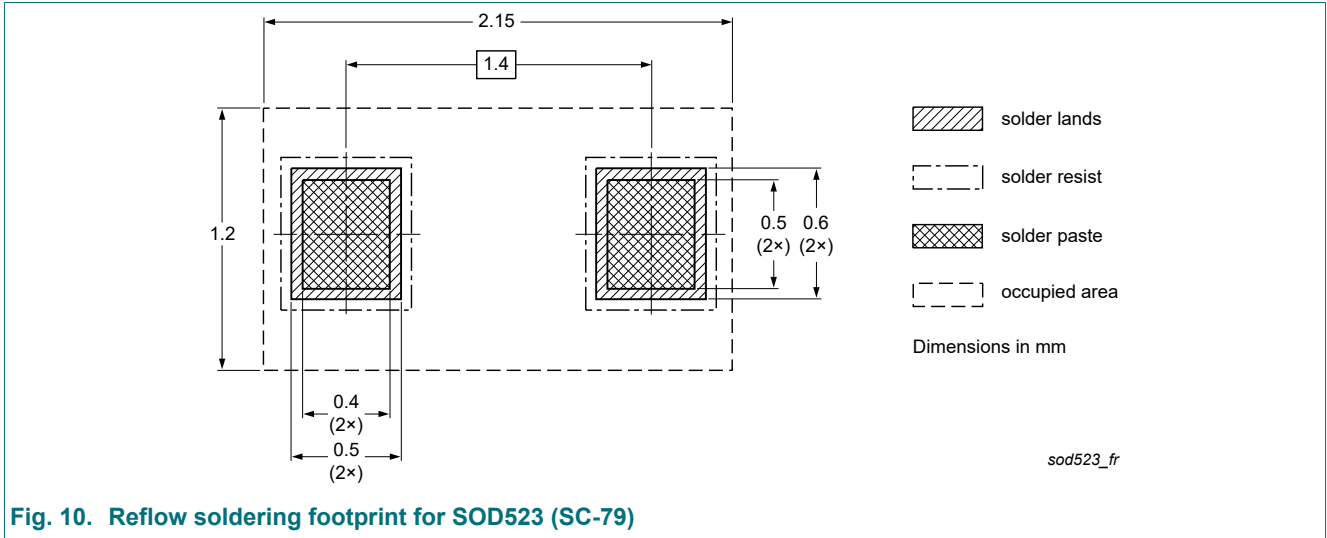

Fig. 10. Reflow soldering footprint for SOD523 (SC-79)

13. Revision history

Table 10. Revision history

Document ID	Release date	Data sheet status	Change notice	Supersedes
BZX58550_SER v.3	20240726	Product data sheet	-	BZX58550_SER v.2
Modifications:	• B and C selections 11 V up to 51 V added			
BZX58550_SER v.2	20230118	Product data sheet	-	BZX58550_SER v.1
BZX58550_SER v.1	20210824	Product data sheet	-	-

14. Legal information

Data sheet status

Document status [1][2]	Product status [3]	Definition
Objective [short] data sheet	Development	This document contains data from the objective specification for product development.
Preliminary [short] data sheet	Qualification	This document contains data from the preliminary specification.
Product [short] data sheet	Production	This document contains the product specification.

- [1] Please consult the most recently issued document before initiating or completing a design.
- [2] The term 'short data sheet' is explained in section "Definitions".
- [3] The product status of device(s) described in this document may have changed since this document was published and may differ in case of multiple devices. The latest product status information is available on the internet at <https://www.nexperia.com>.

Definitions

Draft — The document is a draft version only. The content is still under internal review and subject to formal approval, which may result in modifications or additions. Nexperia does not give any representations or warranties as to the accuracy or completeness of information included herein and shall have no liability for the consequences of use of such information.

Short data sheet — A short data sheet is an extract from a full data sheet with the same product type number(s) and title. A short data sheet is intended for quick reference only and should not be relied upon to contain detailed and full information. For detailed and full information see the relevant full data sheet, which is available on request via the local Nexperia sales office. In case of any inconsistency or conflict with the short data sheet, the full data sheet shall prevail.

Product specification — The information and data provided in a Product data sheet shall define the specification of the product as agreed between Nexperia and its customer, unless Nexperia and customer have explicitly agreed otherwise in writing. In no event however, shall an agreement be valid in which the Nexperia product is deemed to offer functions and qualities beyond those described in the Product data sheet.

Disclaimers

Limited warranty and liability — Information in this document is believed to be accurate and reliable. However, Nexperia does not give any representations or warranties, expressed or implied, as to the accuracy or completeness of such information and shall have no liability for the consequences of use of such information. Nexperia takes no responsibility for the content in this document if provided by an information source outside of Nexperia.

In no event shall Nexperia be liable for any indirect, incidental, punitive, special or consequential damages (including - without limitation - lost profits, lost savings, business interruption, costs related to the removal or replacement of any products or rework charges) whether or not such damages are based on tort (including negligence), warranty, breach of contract or any other legal theory.

Notwithstanding any damages that customer might incur for any reason whatsoever, Nexperia's aggregate and cumulative liability towards customer for the products described herein shall be limited in accordance with the Terms and conditions of commercial sale of Nexperia.

Right to make changes — Nexperia reserves the right to make changes to information published in this document, including without limitation specifications and product descriptions, at any time and without notice. This document supersedes and replaces all information supplied prior to the publication hereof.

Suitability for use — Nexperia products are not designed, authorized or warranted to be suitable for use in life support, life-critical or safety-critical systems or equipment, nor in applications where failure or malfunction of an Nexperia product can reasonably be expected to result in personal

injury, death or severe property or environmental damage. Nexperia and its suppliers accept no liability for inclusion and/or use of Nexperia products in such equipment or applications and therefore such inclusion and/or use is at the customer's own risk.

Quick reference data — The Quick reference data is an extract of the product data given in the Limiting values and Characteristics sections of this document, and as such is not complete, exhaustive or legally binding.

Applications — Applications that are described herein for any of these products are for illustrative purposes only. Nexperia makes no representation or warranty that such applications will be suitable for the specified use without further testing or modification.

Customers are responsible for the design and operation of their applications and products using Nexperia products, and Nexperia accepts no liability for any assistance with applications or customer product design. It is customer's sole responsibility to determine whether the Nexperia product is suitable and fit for the customer's applications and products planned, as well as for the planned application and use of customer's third party customer(s). Customers should provide appropriate design and operating safeguards to minimize the risks associated with their applications and products.

Nexperia does not accept any liability related to any default, damage, costs or problem which is based on any weakness or default in the customer's applications or products, or the application or use by customer's third party customer(s). Customer is responsible for doing all necessary testing for the customer's applications and products using Nexperia products in order to avoid a default of the applications and the products or of the application or use by customer's third party customer(s). Nexperia does not accept any liability in this respect.

Limiting values — Stress above one or more limiting values (as defined in the Absolute Maximum Ratings System of IEC 60134) will cause permanent damage to the device. Limiting values are stress ratings only and (proper) operation of the device at these or any other conditions above those given in the Recommended operating conditions section (if present) or the Characteristics sections of this document is not warranted. Constant or repeated exposure to limiting values will permanently and irreversibly affect the quality and reliability of the device.

Terms and conditions of commercial sale — Nexperia products are sold subject to the general terms and conditions of commercial sale, as published at <http://www.nexperia.com/profile/terms>, unless otherwise agreed in a valid written individual agreement. In case an individual agreement is concluded only the terms and conditions of the respective agreement shall apply. Nexperia hereby expressly objects to applying the customer's general terms and conditions with regard to the purchase of Nexperia products by customer.

No offer to sell or license — Nothing in this document may be interpreted or construed as an offer to sell products that is open for acceptance or the grant, conveyance or implication of any license under any copyrights, patents or other industrial or intellectual property rights.

Export control — This document as well as the item(s) described herein may be subject to export control regulations. Export might require a prior authorization from competent authorities.

Non-automotive qualified products — Unless this data sheet expressly states that this specific Nexperia product is automotive qualified, the product is not suitable for automotive use. It is neither qualified nor tested in accordance with automotive testing or application requirements. Nexperia accepts no liability for inclusion and/or use of non-automotive qualified products in automotive equipment or applications.

In the event that customer uses the product for design-in and use in automotive applications to automotive specifications and standards, customer (a) shall use the product without Nexperia's warranty of the product for such automotive applications, use and specifications, and (b) whenever customer uses the product for automotive applications beyond Nexperia's specifications such use shall be solely at customer's own risk, and (c) customer fully indemnifies Nexperia for any liability, damages or failed product claims resulting from customer design and use of the product for automotive applications beyond Nexperia's standard warranty and Nexperia's product specifications.

Translations — A non-English (translated) version of a document is for reference only. The English version shall prevail in case of any discrepancy between the translated and English versions.

Trademarks

Notice: All referenced brands, product names, service names and trademarks are the property of their respective owners.

Contents

1. General description.....	1
2. Features and benefits.....	1
3. Applications.....	1
4. Quick reference data.....	1
5. Pinning information.....	1
6. Ordering information.....	2
7. Marking.....	2
8. Limiting values.....	3
9. Thermal characteristics.....	3
10. Characteristics.....	3
11. Package outline.....	8
12. Soldering.....	9
13. Revision history.....	10
14. Legal information.....	11

© Nexperia B.V. 2024. All rights reserved

For more information, please visit: <http://www.nexperia.com>

For sales office addresses, please send an email to: salesaddresses@nexperia.com

Date of release: 26 July 2024

Looking for pricing, stock, or lifecycle information?

Click below to explore more details on WIN SOURCE:

- [View C0603B106M007T on WIN SOURCE](#)
- [Holy Stone Enterprise Co., Ltd. Information](#)

Optimize Your Supply Chain with WIN SOURCE Solutions

- ✓ Global Sourcing Solution
- ✓ Obsolete Management
- ✓ Cost Control Management
- ✓ Shortage Management
- ✓ Alternative Solution
- ✓ Excess Inventory Management