



**THE DATASHEET OF
BQ25756RRVR**



AC Voltage Zero Cross Detection IC

BM1Z002FJ BM1Z003FJ

General Description

This IC outputs the AC voltage zero cross timing detection with high accuracy. By eliminating the need for photocoupler and external components required in conventional applications, it is possible to reduce the number of parts drastically and realize compact and highly reliable power supply applications. In addition, this IC can reduce standby power largely in comparison with an existing photocoupler control.

Features

- AC Zero Cross Detection Function
Eliminates Photocoupler
600 V High Voltage Monitor
Modifiable Zero Cross Delay Time
n Channel Open Drain Output
- VCC Under Voltage Locked Out (VCC UVLO)

Applications

- Household Appliances such as Rice Cooker and Dryer, etc.

Key Specifications

- VCC Input Power Supply Voltage Range: -0.3 V to +29 V
- VH_AC1 and VH_AC2 Pins Operation Voltage: 600 V (Max)
- Circuit Current at Standby: 50 μ A (Typ)
- Circuit Current at Operation: 160 μ A (Typ)
- Operating Temperature Range: -40 °C to +105 °C

Package

SOP-J7S

W (Typ) x D (Typ) x H (Max)

4.9 mm x 6.0 mm x 1.65 mm

Pitch (Typ): 1.27 mm



Lineup

Product Name	ACOUT Pin Output Waveform
BM1Z002FJ	Pulse
BM1Z003FJ	Edge

Typical Application Circuit

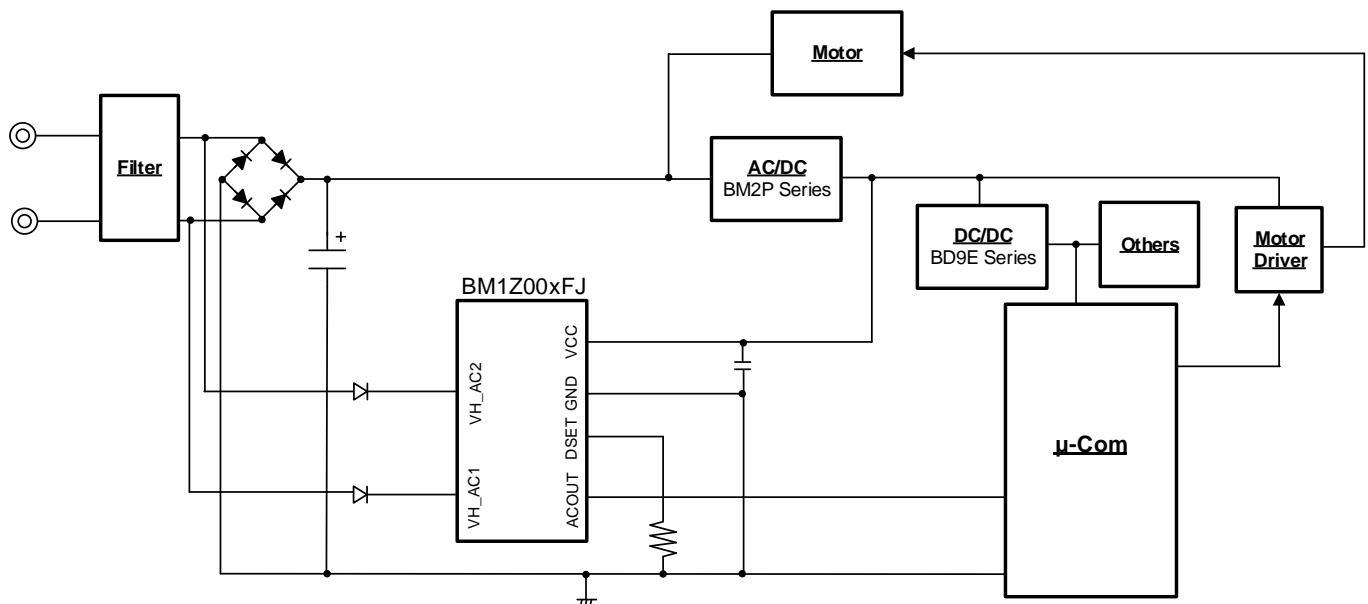

○Product structure : Silicon integrated circuit ○This product has no designed protection against radioactive rays.

Pin Configuration

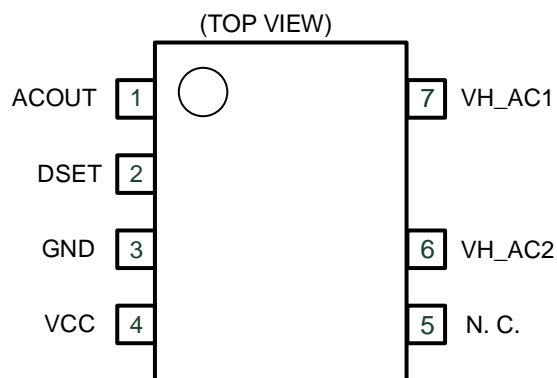

Pin Descriptions

Pin No.	Pin Name	Function
1	ACOUT	AC voltage zero cross timing output pin
2	DSET	AC voltage zero cross delay time setting pin
3	GND	Ground pin
4	VCC	Power supply pin
5	N.C.	Non connection (Do not connect to any pins.)
6	VH_AC2	AC voltage input 2 pin
7	VH_AC1	AC voltage input 1 pin

Description of Blocks

1. AC Voltage Zero Cross Detection

By monitoring the voltage between the VH_AC1 and VH_AC2 pins, this IC outputs the zero cross point of AC voltage from the ACOUT pin. These pins have a built-in monitor circuit that tolerates 600 V and they realize high reliability and low power consumption.

The ACOUT pin performs an n channel open drain output and this makes it possible to support various applications. It is necessary for the VH_AC1 pin to be connected to the N side of the AC input and for the VH_AC2 pin to be connected to the L side of the AC input.

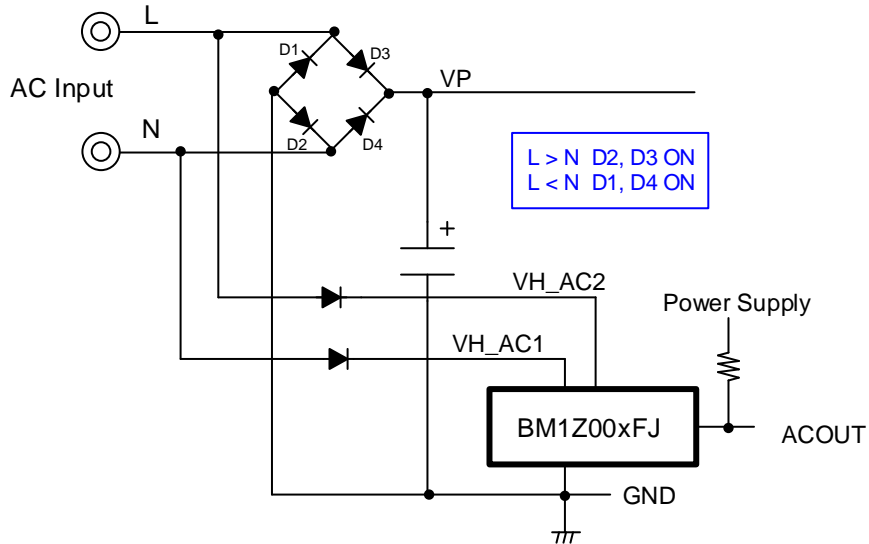

Figure 1. Example of Circuit Diagram

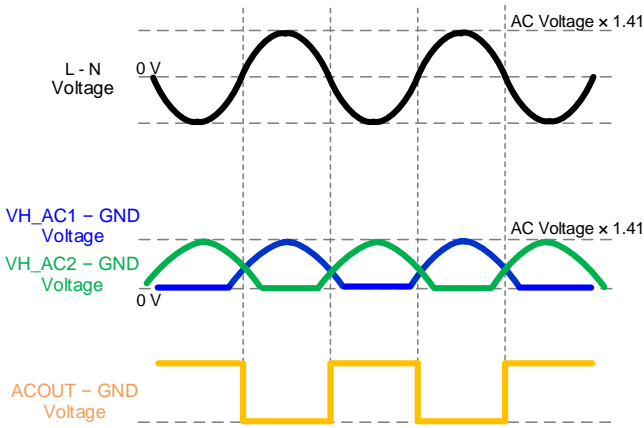

Figure 2. Output Waveform (BM1Z002FJ)

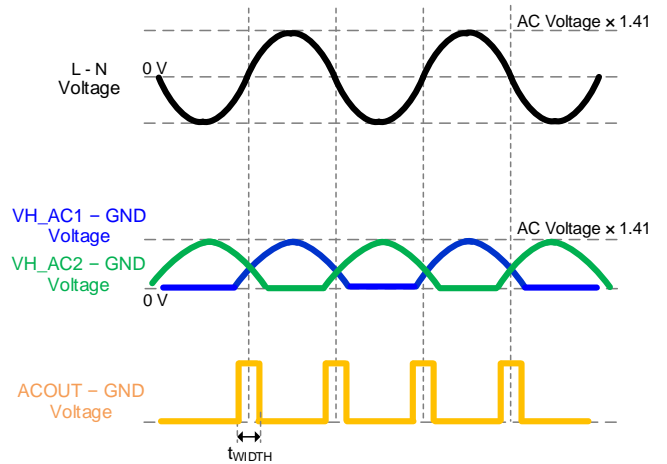

Figure 3. Output Waveform (BM1Z003FJ)

1. AC Voltage Zero Cross Detection – continued

1.1 Startup Sequence

Show a start sequence in Figure 4.

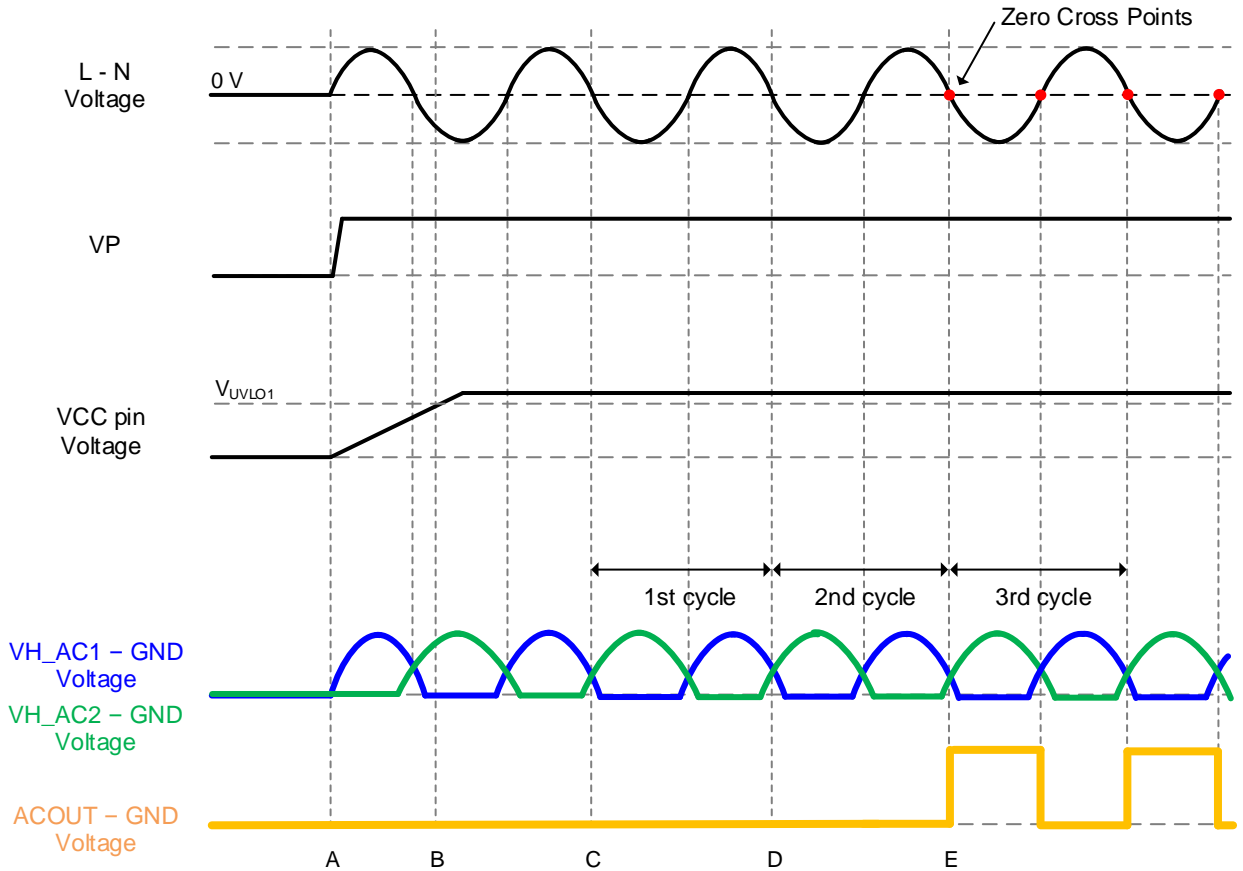

Figure 4. Start Sequence

- A: AC Input voltage is applied.
- B: When the VCC pin voltage becomes more than V_{UVLO1} , the IC starts to operate.
- C: The VH_AC1 and VH_AC2 pins voltage in 1st cycle is detected after the IC starts operation.
- D: The VH_AC1 and VH_AC2 pins voltage in 2nd cycle is detected and the internal arithmetic of IC is completed.
- E: After the arithmetic, the first positive edge point of the ACOUT pin voltage is detected. After that, the IC repeats the high-to-low pulse operation at the zero cross points. (The zero cross detection function starts to operate at 3rd cycle from starting IC's operation.)

1. AC Voltage Zero Cross Detection – continued

1.2 VH_AC1 Pin UVLO

In case that the peak voltage of the VH_AC1 pin is V_{ACUVLO} or less, the ACOUT pin voltage is defined as Hiz.

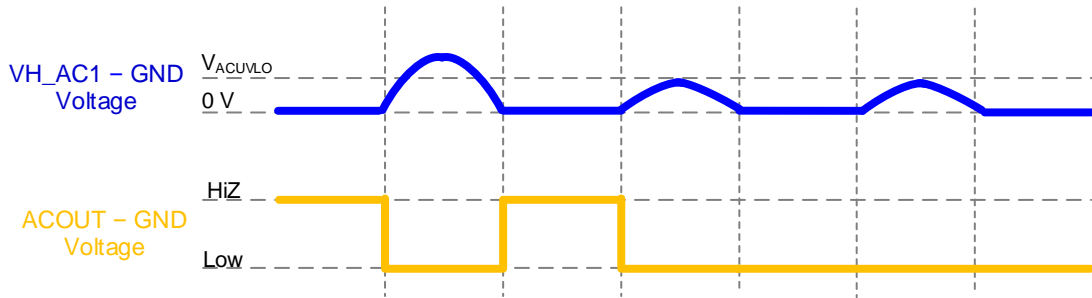

Figure 5. VH_AC1 Pin UVLO

1.3 VH_AC1 and VH_AC2 Pins Noise Filter

This IC has two noise filters.

Noise Filter 1 (t_{AC1}): In case of the ACOUT pin voltage = Hiz, signals of pulse width $< t_{AC1}$ is not accepted.

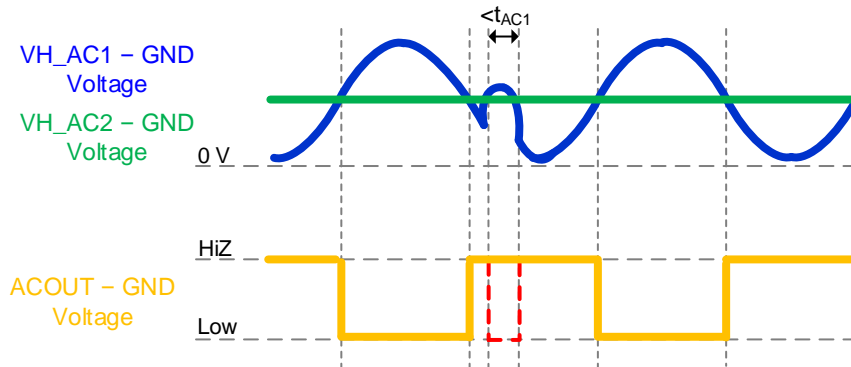

Figure 6. VH_AC1 and VH_AC2 Pins Noise Filter 1

Noise Filter 2 (t_{AC2}): In case of the ACOUT pin voltage = Low, signals of pulse width $< t_{AC2}$ is not accepted.

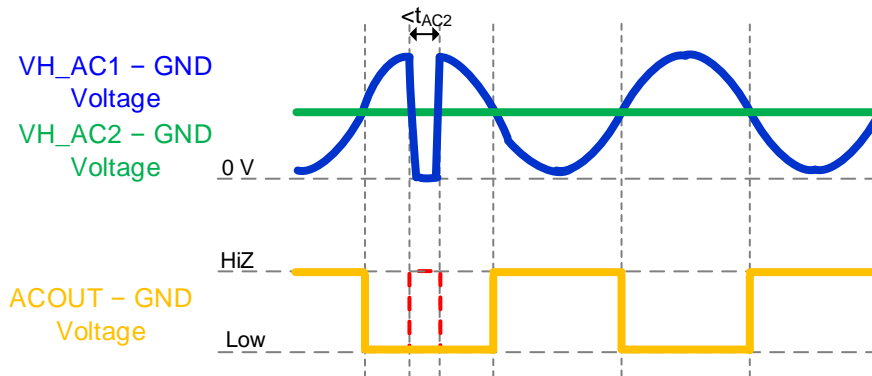

Figure 7. VH_AC1 and VH_AC2 Pins Noise Filter 2

1. AC Voltage Zero Cross Detection – continued

1.4 DSET Pin Setting

The DSET pin is connected to internal power supply VREF and the DSET pin voltage is depended on the value of R_{DSET} . The zero cross delay time is set by the level of the DSET pin. Set it to one of the values in Table 1.

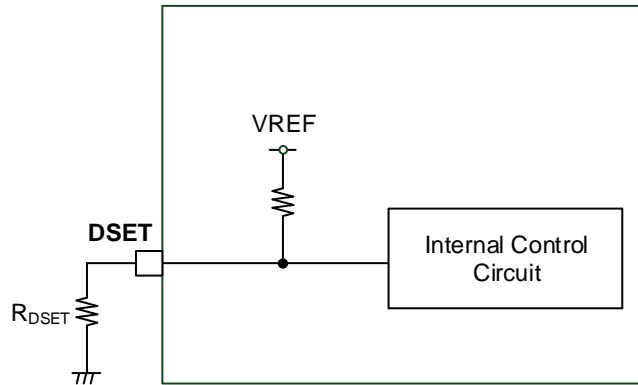

Figure 8. Circuit Diagram of DSET Pin

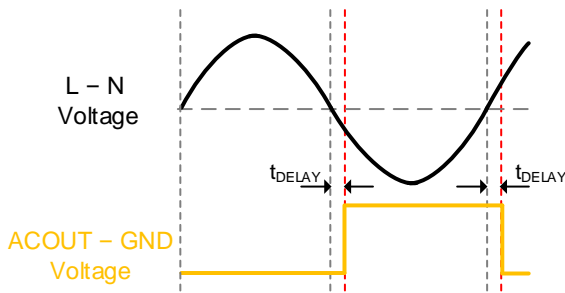

Figure 9. Zero Cross Delay Time (BM1Z002FJ)

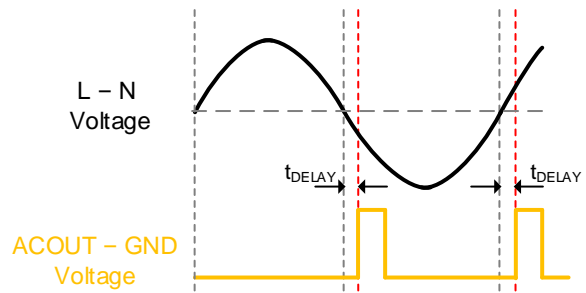

Figure 10. Zero Cross Delay Time (BM1Z003FJ)

Table 1. Zero Cross Delay Time by Adjusting R_{DSET}

R_{DSET}	Zero Cross Delay Time t_{DELAY} (μ s)
Open	0
330 k Ω	+200
68 k Ω	-200
GND	-480

Absolute Maximum Ratings (Ta = 25 °C)

Parameter	Symbol	Rating	Unit
VCC Input Power Supply Voltage	V _{CC}	-0.3 to +29	V
VH_AC1 Pin Voltage	V _{VH_AC1}	-0.3 to +600	V
VH_AC2 Pin Voltage	V _{VH_AC2}	-0.3 to +600	V
ACOUT Pin Voltage	V _{ACOUT}	-0.3 to +29	V
DSET Pin Voltage	V _{DSET}	-0.3 to +7	V
Allowable Dissipation ^(Note 1)	P _d	0.83	W
Storage Temperature Range	T _{stg}	-55 to +150	°C
Maximum Junction Temperature	T _{jmax}	150	°C

Caution 1: Operating the IC over the absolute maximum ratings may damage the IC. The damage can either be a short circuit between pins or an open circuit between pins and the internal circuitry. Therefore, it is important to consider circuit protection measures, such as adding a fuse, in case the IC is operated over the absolute maximum ratings.

Caution 2: Should by any chance the maximum junction temperature rating be exceeded the rise in temperature of the chip may result in deterioration of the properties of the chip. In case of exceeding this absolute maximum rating, design a PCB with power dissipation taken into consideration by increasing board size and copper area so as not to exceed the maximum junction temperature rating.

(Note 1) SOP-J7S: At mounted on a glass epoxy single layer PCB (114.3 mm x 76.2 mm x 1.6 mm). Derate by 6.64 mW/°C if the IC is used in the ambient temperature 25 °C or above.

Thermal Loss

Make the thermal design so that the IC operates in the following conditions.
 (Because the following temperature is guarantee value, it is necessary to consider margin.)

1. The ambient temperature must be 105 °C or less.
2. The IC's loss must be the allowable dissipation Pd or less.

The thermal abatement characteristics are as follows.
 (At mounting on a glass epoxy single layer PCB which size is 114.3 mm x 76.2 mm x 1.6 mm.)

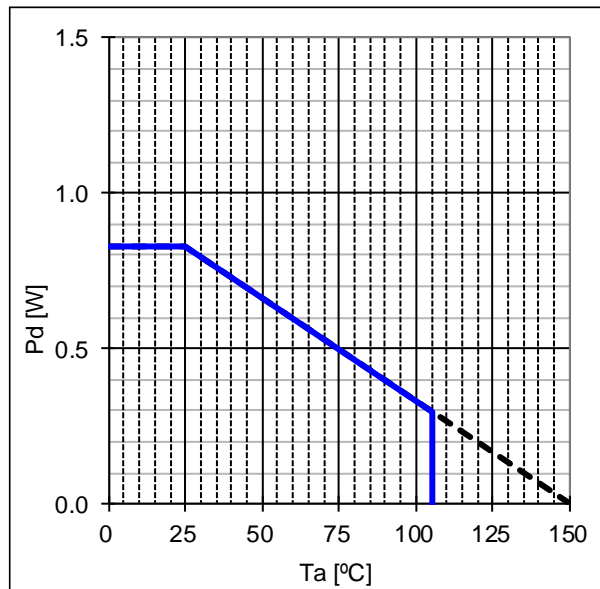

Figure 11. SOP-J7S Thermal Abatement Characteristic

Recommended Operating Conditions

Parameter	Symbol	Min	Typ	Max	Unit
VCC Input Power Supply Voltage	V _{CC}	10	15	28	V
VH_AC1 Pin Operation Voltage	V _{VH_AC1}	-	-	300 ^(Note 2)	V
VH_AC2 Pin Operation Voltage	V _{VH_AC2}	-	-	300 ^(Note 2)	V
VH_AC1 and VH_AC2 Pins Input Frequency	f _{VH_AC}	45	-	65	Hz
Operating Temperature	Topr	-40	-	+105	°C

(Note 2) The recommendation maximum operating voltage shows AC 300 V which is input AC voltage in the application.

Apply the input AC voltage which is half-wave-rectified to the VH_AC1 and VH_AC2 pins.

Electrical Characteristics

(Unless otherwise specified V_{CC} = 15 V, Ta = 25 °C)

Parameter	Symbol	Min	Typ	Max	Unit	Condition
VCC Block						
Circuit Current at Standby	I _{STBY}	20	50	90	μA	V _{CC} = 5 V
Circuit Current at Operation	I _{CC}	100	160	500	μA	V _{CC} = 15 V
VCC Pin UVLO Detected Voltage	V _{UVLO1}	5.0	6.0	7.0	V	at VCC pin voltage falling
VCC Pin UVLO Released Voltage	V _{UVLO2}	6.0	7.0	8.0	V	at VCC pin voltage rising
VCC Pin UVLO Hysteresis Voltage	V _{UVLO_HYS}	0.5	1.0	1.5	V	
AC Voltage Zero Cross Detection Block						
VH_AC1 Pin Consumption Current	I _{VH_AC1}	15	30	45	μA	V _{VH_AC1} = 300 V
VH_AC2 Pin Consumption Current	I _{VH_AC2}	15	30	45	μA	V _{VH_AC2} = 300 V
VH_AC1 Pin UVLO Detection Voltage	V _{ACUVLO}	10	20	30	V	
VH_AC1 and VH_AC2 Pins Noise Filter 1	t _{AC1}	1.00	1.27	1.54	ms	
VH_AC1 and VH_AC2 Pins Noise Filter 2	t _{AC2}	1.38	1.73	2.08	ms	
ACOUT Pin Leak Current	I _{ACOUT}	-	0.0	1.0	μA	V _{ACOUT} = 5 V
ACOUT Pin On Resistance	R _{ACOUT}	-	50	100	Ω	
ACOUT Output Block						
Zero Cross Delay Time 1	t _{DELAY1}	-40	0	+40	μs	R _{DSET} = open
Zero Cross Delay Time 2	t _{DELAY2}	150	200	250	μs	R _{DSET} = 330 kΩ
Zero Cross Delay Time 3	t _{DELAY3}	-250	-200	-150	μs	R _{DSET} = 68 kΩ
Zero Cross Delay Time 4	t _{DELAY4}	-540	-480	-420	μs	R _{DSET} = GND
Zero Cross Edge Width	t _{WIDTH}	0.9	1.0	1.1	ms	BM1Z003FJ Only

Typical Performance Curves

(Reference data)

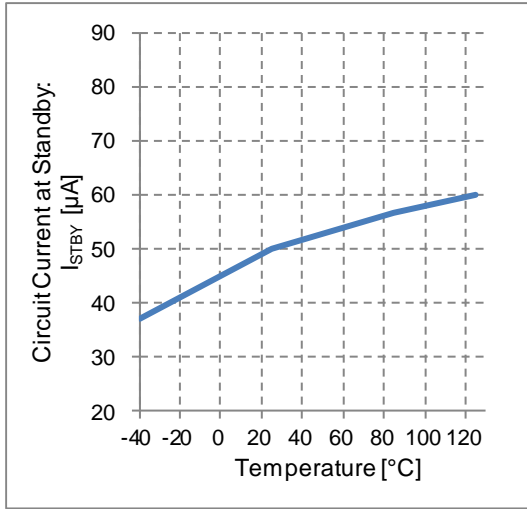

Figure 12. Circuit Current at Standby vs Temperature

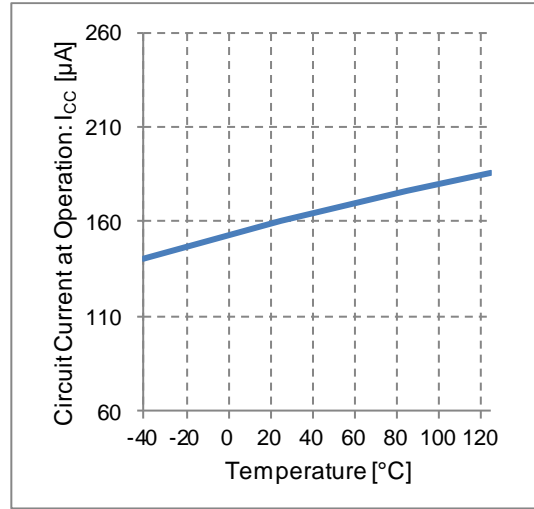

Figure 13. Circuit Current at Operation vs Temperature

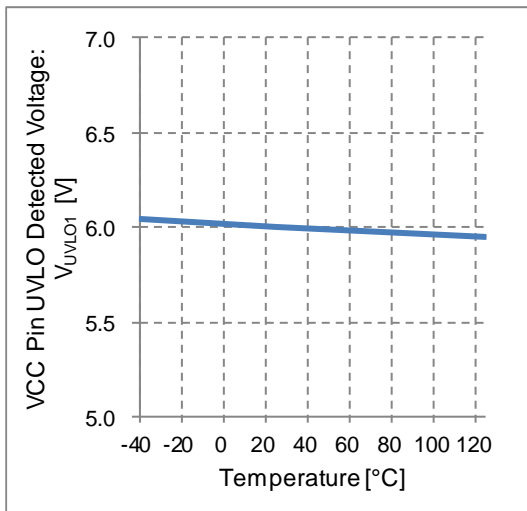

Figure 14. VCC Pin UVLO Detected Voltage vs Temperature

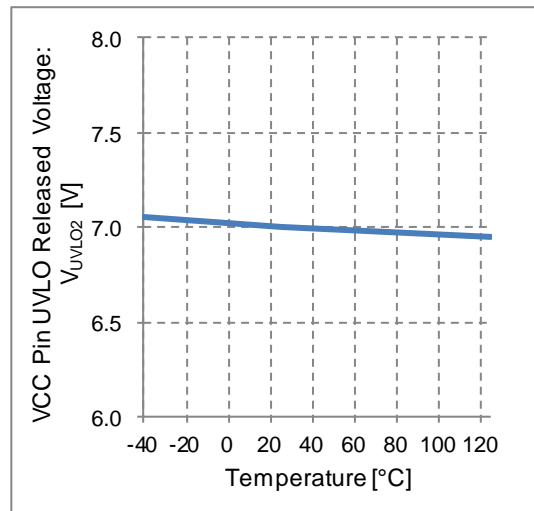

Figure 15. VCC Pin UVLO Released Voltage vs Temperature

Typical Performance Curves – continued
(Reference data)

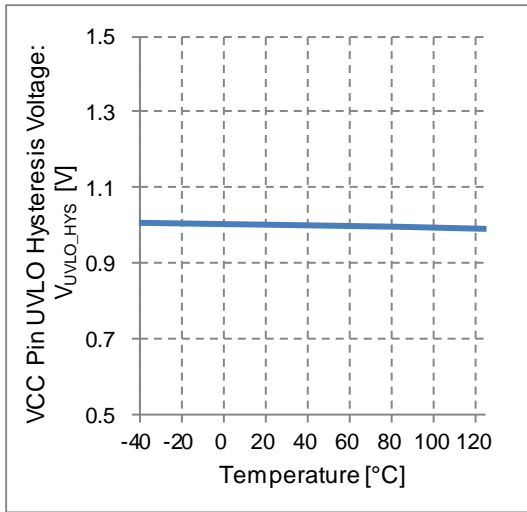

Figure 16. VCC Pin UVLO Hysteresis Voltage vs Temperature

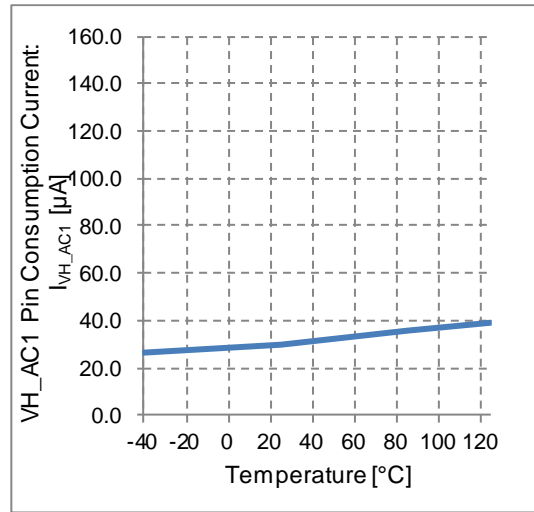

Figure 17. VH_AC1 Pin Consumption Current vs Temperature

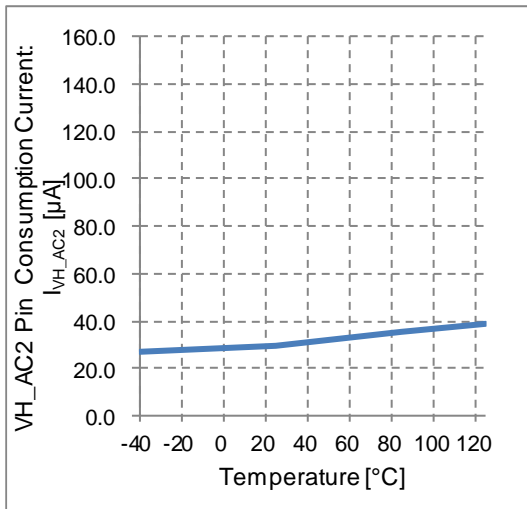

Figure 18. VH_AC2 Pin Consumption Current vs Temperature

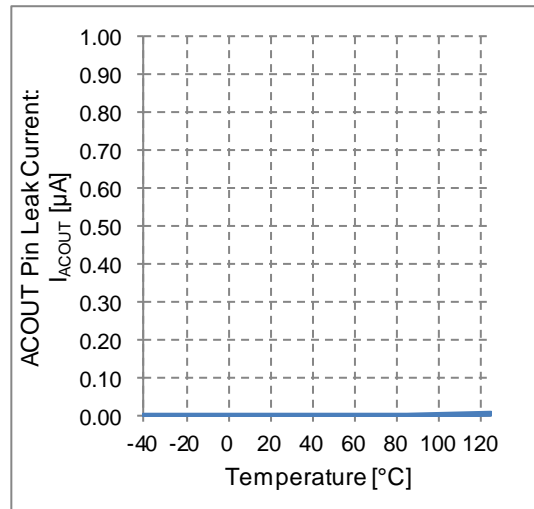

Figure 19. ACOUT Pin Leak Current vs Temperature

Typical Performance Curves – continued
(Reference data)

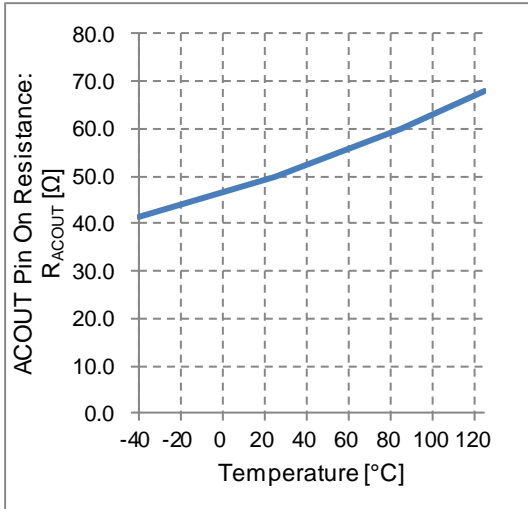

Figure 20. ACOUT Pin On Resistance vs Temperature

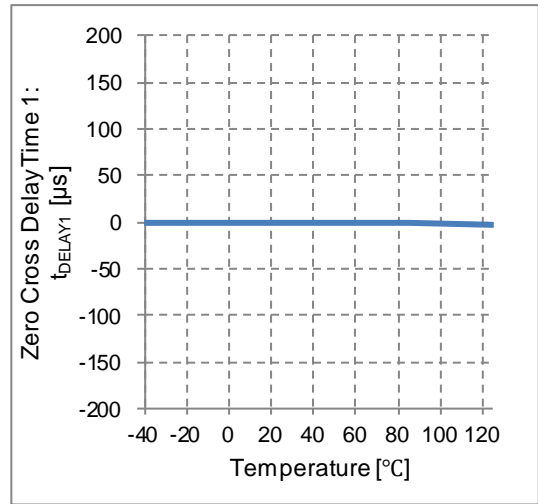

Figure 21. Zero Cross Delay Time 1 vs Temperature

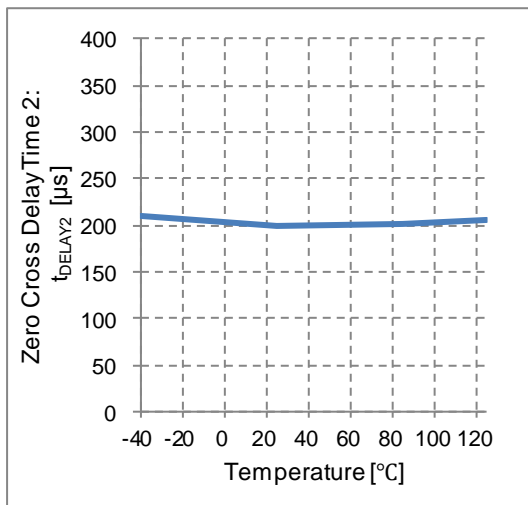

Figure 22. Zero Cross Delay Time 2 vs Temperature

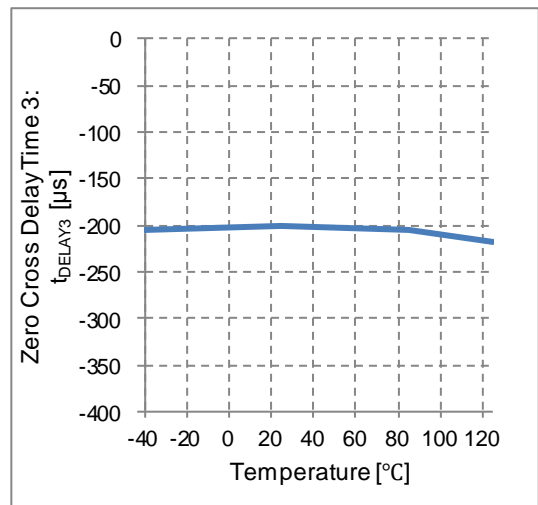

Figure 23. Zero Cross Delay Time 3 vs Temperature

Typical Performance Curves – continued
(Reference data)

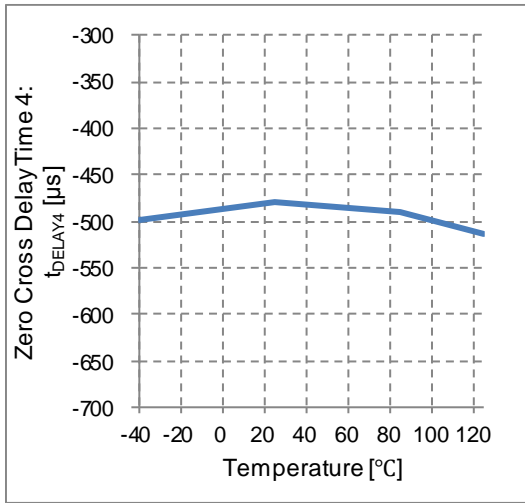

Figure 24. Zero Cross Delay Time 4 vs Temperature

I/O Equivalence Circuit

7	VH_AC1	-	-	6	VH_AC2	5	N. C.
		-				Non Connction	
1	ACOUT	2	DSET	3	GND	4	VCC

Operational Notes

1. Reverse Connection of Power Supply

Connecting the power supply in reverse polarity can damage the IC. Take precautions against reverse polarity when connecting the power supply, such as mounting an external diode between the power supply and the IC's power supply pins.

2. Power Supply Lines

Design the PCB layout pattern to provide low impedance supply lines. Furthermore, connect a capacitor to ground at all power supply pins. Consider the effect of temperature and aging on the capacitance value when using electrolytic capacitors.

3. Ground Voltage

Ensure that no pins are at a voltage below that of the ground pin at any time, even during transient condition.

4. Ground Wiring Pattern

When using both small-signal and large-current ground traces, the two ground traces should be routed separately but connected to a single ground at the reference point of the application board to avoid fluctuations in the small-signal ground caused by large currents. Also ensure that the ground traces of external components do not cause variations on the ground voltage. The ground lines must be as short and thick as possible to reduce line impedance.

5. Recommended Operating Conditions

The function and operation of the IC are guaranteed within the range specified by the recommended operating conditions. The characteristic values are guaranteed only under the conditions of each item specified by the electrical characteristics.

6. Inrush Current

When power is first supplied to the IC, it is possible that the internal logic may be unstable and inrush current may flow instantaneously due to the internal powering sequence and delays, especially if the IC has more than one power supply. Therefore, give special consideration to power coupling capacitance, power wiring, width of ground wiring, and routing of connections.

7. Testing on Application Boards

When testing the IC on an application board, connecting a capacitor directly to a low-impedance output pin may subject the IC to stress. Always discharge capacitors completely after each process or step. The IC's power supply should always be turned off completely before connecting or removing it from the test setup during the inspection process. To prevent damage from static discharge, ground the IC during assembly and use similar precautions during transport and storage.

8. Inter-pin Short and Mounting Errors

Ensure that the direction and position are correct when mounting the IC on the PCB. Incorrect mounting may result in damaging the IC. Avoid nearby pins being shorted to each other especially to ground, power supply and output pin. Inter-pin shorts could be due to many reasons such as metal particles, water droplets (in very humid environment) and unintentional solder bridge deposited in between pins during assembly to name a few.

9. Unused Input Pins

Input pins of an IC are often connected to the gate of a MOS transistor. The gate has extremely high impedance and extremely low capacitance. If left unconnected, the electric field from the outside can easily charge it. The small charge acquired in this way is enough to produce a significant effect on the conduction through the transistor and cause unexpected operation of the IC. So unless otherwise specified, unused input pins should be connected to the power supply or ground line.

Operational Notes – continued

10. Regarding the Input Pin of the IC

This IC contains P+ isolation and P substrate layers between adjacent elements in order to keep them isolated. P-N junctions are formed at the intersection of the P layers with the N layers of other elements, creating a parasitic diode or transistor. For example (refer to figure below):

- When GND > Pin A and GND > Pin B, the P-N junction operates as a parasitic diode.
- When GND > Pin B, the P-N junction operates as a parasitic transistor.

Parasitic diodes inevitably occur in the structure of the IC. The operation of parasitic diodes can result in mutual interference among circuits, operational faults, or physical damage. Therefore, conditions that cause these diodes to operate, such as applying a voltage lower than the GND voltage to an input pin (and thus to the P substrate) should be avoided.

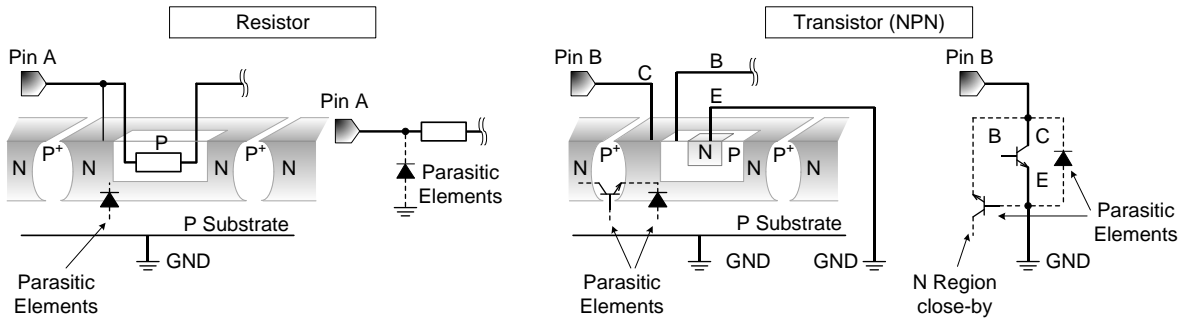

Figure 25. Example of IC Structure

11. Ceramic Capacitor

When using a ceramic capacitor, determine a capacitance value considering the change of capacitance with temperature and the decrease in nominal capacitance due to DC bias and others.

12. Thermal Shutdown Circuit (TSD)

This IC has a built-in thermal shutdown circuit that prevents heat damage to the IC. Normal operation should always be within the IC's maximum junction temperature rating. If however the rating is exceeded for a continued period, the junction temperature (T_j) will rise which will activate the TSD circuit that will turn OFF power output pins. When the T_j falls below the TSD threshold, the circuits are automatically restored to normal operation.

Note that the TSD circuit operates in a situation that exceeds the absolute maximum ratings and therefore, under no circumstances, should the TSD circuit be used in a set design or for any purpose other than protecting the IC from heat damage.

13. Over Current Protection Circuit (OCP)

This IC incorporates an integrated overcurrent protection circuit that is activated when the load is shorted. This protection circuit is effective in preventing damage due to sudden and unexpected incidents. However, the IC should not be used in applications characterized by continuous operation or transitioning of the protection circuit.

Ordering Information

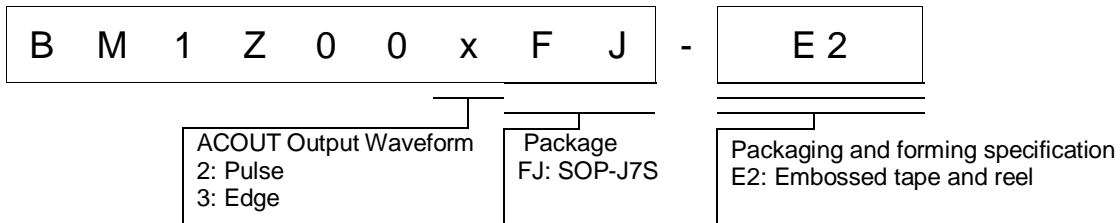

Marking Diagram

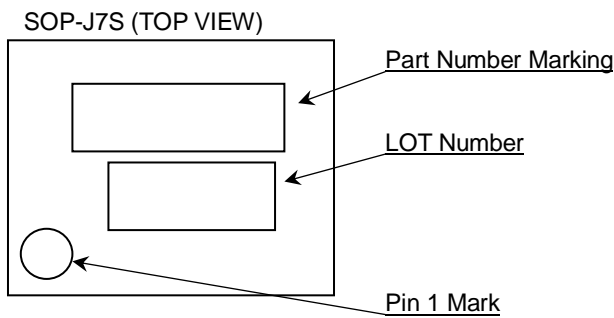

Orderable Part Number	Part Number Marking	ACOUT Pin Output Waveform
BM1Z002FJ-E2	1Z002	Pulse
BM1Z003FJ-E2	1Z003	Edge

Revision History

Date	Revision	Changes
12.Mar.2020	001	New Release

Notice

Precaution on using ROHM Products

- Our Products are designed and manufactured for application in ordinary electronic equipment (such as AV equipment, OA equipment, telecommunication equipment, home electronic appliances, amusement equipment, etc.). If you intend to use our Products in devices requiring extremely high reliability (such as medical equipment ^(Note 1), transport equipment, traffic equipment, aircraft/spacecraft, nuclear power controllers, fuel controllers, car equipment including car accessories, safety devices, etc.) and whose malfunction or failure may cause loss of human life, bodily injury or serious damage to property ("Specific Applications"), please consult with the ROHM sales representative in advance. Unless otherwise agreed in writing by ROHM in advance, ROHM shall not be in any way responsible or liable for any damages, expenses or losses incurred by you or third parties arising from the use of any ROHM's Products for Specific Applications.

(Note1) Medical Equipment Classification of the Specific Applications

JAPAN	USA	EU	CHINA
CLASS III	CLASS III	CLASS II b	CLASS III
CLASS IV		CLASS III	

- ROHM designs and manufactures its Products subject to strict quality control system. However, semiconductor products can fail or malfunction at a certain rate. Please be sure to implement, at your own responsibilities, adequate safety measures including but not limited to fail-safe design against the physical injury, damage to any property, which a failure or malfunction of our Products may cause. The following are examples of safety measures:
 - Installation of protection circuits or other protective devices to improve system safety
 - Installation of redundant circuits to reduce the impact of single or multiple circuit failure
- Our Products are designed and manufactured for use under standard conditions and not under any special or extraordinary environments or conditions, as exemplified below. Accordingly, ROHM shall not be in any way responsible or liable for any damages, expenses or losses arising from the use of any ROHM's Products under any special or extraordinary environments or conditions. If you intend to use our Products under any special or extraordinary environments or conditions (as exemplified below), your independent verification and confirmation of product performance, reliability, etc. prior to use, must be necessary:
 - Use of our Products in any types of liquid, including water, oils, chemicals, and organic solvents
 - Use of our Products outdoors or in places where the Products are exposed to direct sunlight or dust
 - Use of our Products in places where the Products are exposed to sea wind or corrosive gases, including Cl₂, H₂S, NH₃, SO₂, and NO₂
 - Use of our Products in places where the Products are exposed to static electricity or electromagnetic waves
 - Use of our Products in proximity to heat-producing components, plastic cords, or other flammable items
 - Sealing or coating our Products with resin or other coating materials
 - Use of our Products without cleaning residue of flux (Exclude cases where no-clean type fluxes is used. However, recommend sufficiently about the residue.) ; or Washing our Products by using water or water-soluble cleaning agents for cleaning residue after soldering
 - Use of the Products in places subject to dew condensation
- The Products are not subject to radiation-proof design.
- Please verify and confirm characteristics of the final or mounted products in using the Products.
- In particular, if a transient load (a large amount of load applied in a short period of time, such as pulse, is applied, confirmation of performance characteristics after on-board mounting is strongly recommended. Avoid applying power exceeding normal rated power; exceeding the power rating under steady-state loading condition may negatively affect product performance and reliability.
- De-rate Power Dissipation depending on ambient temperature. When used in sealed area, confirm that it is the use in the range that does not exceed the maximum junction temperature.
- Confirm that operation temperature is within the specified range described in the product specification.
- ROHM shall not be in any way responsible or liable for failure induced under deviant condition from what is defined in this document.

Precaution for Mounting / Circuit board design

- When a highly active halogenous (chlorine, bromine, etc.) flux is used, the residue of flux may negatively affect product performance and reliability.
- In principle, the reflow soldering method must be used on a surface-mount products, the flow soldering method must be used on a through hole mount products. If the flow soldering method is preferred on a surface-mount products, please consult with the ROHM representative in advance.

For details, please refer to ROHM Mounting specification

Precautions Regarding Application Examples and External Circuits

1. If change is made to the constant of an external circuit, please allow a sufficient margin considering variations of the characteristics of the Products and external components, including transient characteristics, as well as static characteristics.
2. You agree that application notes, reference designs, and associated data and information contained in this document are presented only as guidance for Products use. Therefore, in case you use such information, you are solely responsible for it and you must exercise your own independent verification and judgment in the use of such information contained in this document. ROHM shall not be in any way responsible or liable for any damages, expenses or losses incurred by you or third parties arising from the use of such information.

Precaution for Electrostatic

This Product is electrostatic sensitive product, which may be damaged due to electrostatic discharge. Please take proper caution in your manufacturing process and storage so that voltage exceeding the Products maximum rating will not be applied to Products. Please take special care under dry condition (e.g. Grounding of human body / equipment / solder iron, isolation from charged objects, setting of Ionizer, friction prevention and temperature / humidity control).

Precaution for Storage / Transportation

1. Product performance and soldered connections may deteriorate if the Products are stored in the places where:
 - [a] the Products are exposed to sea winds or corrosive gases, including Cl₂, H₂S, NH₃, SO₂, and NO₂
 - [b] the temperature or humidity exceeds those recommended by ROHM
 - [c] the Products are exposed to direct sunshine or condensation
 - [d] the Products are exposed to high Electrostatic
2. Even under ROHM recommended storage condition, solderability of products out of recommended storage time period may be degraded. It is strongly recommended to confirm solderability before using Products of which storage time is exceeding the recommended storage time period.
3. Store / transport cartons in the correct direction, which is indicated on a carton with a symbol. Otherwise bent leads may occur due to excessive stress applied when dropping of a carton.
4. Use Products within the specified time after opening a humidity barrier bag. Baking is required before using Products of which storage time is exceeding the recommended storage time period.

Precaution for Product Label

A two-dimensional barcode printed on ROHM Products label is for ROHM's internal use only.

Precaution for Disposition

When disposing Products please dispose them properly using an authorized industry waste company.

Precaution for Foreign Exchange and Foreign Trade act

Since concerned goods might be fallen under listed items of export control prescribed by Foreign exchange and Foreign trade act, please consult with ROHM in case of export.

Precaution Regarding Intellectual Property Rights

1. All information and data including but not limited to application example contained in this document is for reference only. ROHM does not warrant that foregoing information or data will not infringe any intellectual property rights or any other rights of any third party regarding such information or data.
2. ROHM shall not have any obligations where the claims, actions or demands arising from the combination of the Products with other articles such as components, circuits, systems or external equipment (including software).
3. No license, expressly or implied, is granted hereby under any intellectual property rights or other rights of ROHM or any third parties with respect to the Products or the information contained in this document. Provided, however, that ROHM will not assert its intellectual property rights or other rights against you or your customers to the extent necessary to manufacture or sell products containing the Products, subject to the terms and conditions herein.

Other Precaution

1. This document may not be reprinted or reproduced, in whole or in part, without prior written consent of ROHM.
2. The Products may not be disassembled, converted, modified, reproduced or otherwise changed without prior written consent of ROHM.
3. In no event shall you use in any way whatsoever the Products and the related technical information contained in the Products or this document for any military purposes, including but not limited to, the development of mass-destruction weapons.
4. The proper names of companies or products described in this document are trademarks or registered trademarks of ROHM, its affiliated companies or third parties.

General Precaution

1. Before you use our Products, you are requested to carefully read this document and fully understand its contents. ROHM shall not be in any way responsible or liable for failure, malfunction or accident arising from the use of any ROHM's Products against warning, caution or note contained in this document.
2. All information contained in this document is current as of the issuing date and subject to change without any prior notice. Before purchasing or using ROHM's Products, please confirm the latest information with a ROHM sales representative.
3. The information contained in this document is provided on an "as is" basis and ROHM does not warrant that all information contained in this document is accurate and/or error-free. ROHM shall not be in any way responsible or liable for any damages, expenses or losses incurred by you or third parties resulting from inaccuracy or errors of or concerning such information.

Looking for pricing, stock, or lifecycle information?

Click below to explore more details on WIN SOURCE:

 [View BQ25756RRVR](#) on WIN SOURCE

 [Texas Instruments](#) Information

Optimize Your Supply Chain with WIN SOURCE Solutions

-  Global Sourcing Solution
-  Obsolete Management
-  Cost Control Management
-  Shortage Management
-  Alternative Solution
-  Excess Inventory Management