



**THE DATASHEET OF
AS333W5-7**



Description

The AS333 is a high precision operational amplifier designed with chopping stabilization technique which eliminates 1/f noise, and the cross over distortion presented in most RRIO amplifiers.

The AS333, RRIO amplifier (rail-to-rail input and output), provides not only maximum output voltage swing capability but also an extended 100mV common-mode voltage beyond the supply rail. The device is fully specified to operate from 1.8V to 5.5V single supply, or $\pm 0.9V$ and $\pm 2.5V$ dual supply applications.

The device features a good speed/power consumption ratio, offering 350kHz gain bandwidth while consuming only 17 μA quiescent current. With the low input offset voltage 8 μV and zero-drift offset voltage 0.02 $\mu V/^{\circ}C$, it is ideal for applications that require precision, especially for low power and high precision ones.

The AS333 is available in SOT25 and SOT353 packages, and is specified for operation from $-40^{\circ}C$ to $+125^{\circ}C$ among all supply voltages. The wide temperature ranges and high ESD tolerance facilitate their use in harsh applications.

Features

- Low Input Offset Voltage: 8 μV (typ)
- Zero Drift: 0.02 $\mu V/^{\circ}C$ (typ)
- 0.01Hz to 10Hz Noise: 1.1 μV_{PP}
- Low Quiescent Current: 17 μA (typ)
- Supply Voltage: 1.8V to 5.5V
- Rail-to-Rail Input and Output
 - V_{CM} : 100mV Beyond Supply Rail @ $V_{CC} = 1.8V$ to 5.5V
- Unity Gain Stable up to 200pF C-Load
 - Gain Bandwidth: 350kHz
- Slew Rate 0.12V/ μs (typ)
- Operation Ambient Temperature Range: $-40^{\circ}C$ to $+125^{\circ}C$
- ESD Protection JESD 22, 4000V HBM (A114)
- SOT25 and SOT353 Packages
- **Totally Lead-Free & Fully RoHS Compliant (Notes 1 & 2)**
- **Halogen and Antimony Free. "Green" Device (Note 3)**
- **For automotive applications requiring specific change control (i.e. parts qualified to AEC-Q100/101/104/200, PPAP capable, and manufactured in IATF 16949 certified facilities), please [contact us](mailto:contact@diodes.com) or your local Diodes representative. <https://www.diodes.com/quality/product-definitions/>**

- Notes:
1. No purposely added lead. Fully EU Directive 2002/95/EC (RoHS), 2011/65/EU (RoHS 2) & 2015/863/EU (RoHS 3) compliant.
 2. See <https://www.diodes.com/quality/lead-free/> for more information about Diodes Incorporated's definitions of Halogen- and Antimony-free, "Green" and Lead-free.
 3. Halogen- and Antimony-free "Green" products are defined as those which contain <900ppm bromine, <900ppm chlorine (<1500ppm total Br + Cl) and <1000ppm antimony compounds.

Pin Assignments

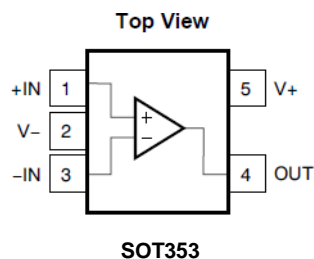
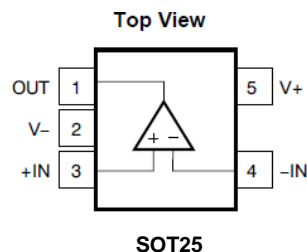

Applications

- Battery-powered instruments
- Handheld test equipment
- Medical instrumentation
- Low voltage current sensing
- Sensor signal conditioning
- Sensors interfaces
- CO detectors, pressure sensors, smoke alarms, pulse blood oximeters, glucose meters

Typical Application

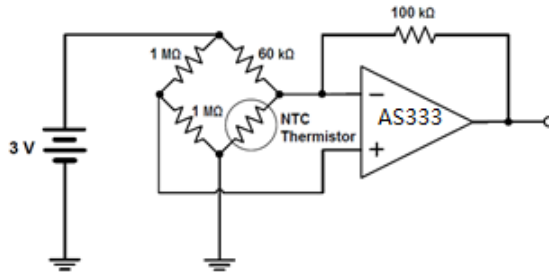

Thermistor Measurement

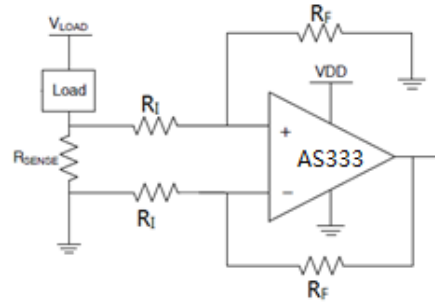

Low-Side Current Monitor

Pin Descriptions

Pin Name	Package Name		I/O	Function
	SOT25	SOT353		
+IN	3	1	I	Noninverting Input
-IN	4	3	I	Inverting Input
OUT	1	4	O	Output
V+	5	5	—	Positive Power Supply
V-	2	2	—	Negative Power Supply

Absolute Maximum Ratings (Note 4)

Symbol	Parameter	Rating		Unit
$V_S = V_+ - V_-$	Supply Voltage Range	6.5		V
V_{-IN} / V_{+IN}	Signal Input Terminals (Note 5)	V- - 0.3V to V+ + 0.3V		V
—	Signal Input Terminals (Note 5)	-1 to +1		mA
	Output Short-Circuit (Note 6)	Continuous		mA
T_{STG}	Storage Temperature	-65 to +150		°C
T_J	Maximum Junction Temperature	+150		°C
T_{LEAD}	Lead Temperature (Soldering, 10 Seconds)	+260		°C
$R_{\theta JA}$	Junction-to-Ambient Thermal Resistance	SOT25	207	°C/W
		SOT353	298	°C/W
$R_{\theta JC}$	Junction-to-Case Thermal Resistance	SOT25	66	°C/W
		SOT353	76	°C/W
ESD HBM	Human Body Model ESD Protection	4		kV
ESD CDM	Charged-Device Model ESD Protection	1		kV

- Notes:
- Stresses greater than those listed under *Absolute Maximum Ratings* can cause permanent damage to the device. These are stress ratings only, and functional operation of the device at these or any other conditions beyond those indicated under *Recommended Operating Conditions* is not implied. Exposure to *Absolute Maximum Ratings* for extended periods can affect device reliability.
 - Input terminals are diode-clamped to the power-supply rails. Input signals that can swing more than 0.3V beyond the supply rails should be current limited to 10mA or less.
 - Short-circuit to ground.

Recommended Operating Conditions (@ $T_A = +25^\circ\text{C}$, unless otherwise specified.)

Symbol	Parameter	Rating	Unit
$V_S = V_+ - V_-$	Supply Voltage Range	1.8 to 5.5	V
T_A	Operating Ambient Temperature Range	-40 to +125	$^\circ\text{C}$

Electrical Characteristics (@ $T_A = +25^\circ\text{C}$, $V_S = 5.0\text{V}$, $R_L = 10\text{k}\Omega$ connected to $V_{OUT} = V_S/2$, $V_{CM} = V_S/2$, unless otherwise specified.)

Symbol	Parameter	Conditions	Min	Typ	Max	Unit	
Offset Voltage							
V_{OS}	Input Offset Voltage	$V_S = 5\text{V}$	—	8	22	μV	
$\Delta V_{OS}/\Delta T$	Input Offset Voltage Drift (Note 7)	$T_A = -40^\circ\text{C}$ to $+85^\circ\text{C}$	—	0.02	0.1	$\mu\text{V}/^\circ\text{C}$	
		$T_A = -40^\circ\text{C}$ to $+125^\circ\text{C}$	—	—	0.2	$\mu\text{V}/^\circ\text{C}$	
PSRR	Power-Supply Rejection Ratio	$V_S = 1.8\text{V}$ to 5.5V , $T_A = -40^\circ\text{C}$ to $+125^\circ\text{C}$	—	1	10	$\mu\text{V}/\text{V}$	
—	Long-Term Stability	—	(Note 7)			μV	
—	Channel Separation, DC	—	—	0.1	—	$\mu\text{V}/\text{V}$	
Input Bias Current							
I_B	Input Bias Current	$T_A = +25^\circ\text{C}$	—	± 70	± 200	pA	
		$T_A = -40^\circ\text{C}$ to $+125^\circ\text{C}$	—	± 400	—		
I_{OS}	Input Offset Current	—	—	± 140	± 400	pA	
Noise							
V_N	Input Voltage Noise	$f = 0.01\text{Hz}$ to 1Hz	—	0.3	—	μV_{PP}	
		$f = 0.1\text{Hz}$ to 10Hz	—	1.1	—		
I_N	Input Current Noise	$f = 10\text{Hz}$	—	100	—	$\text{fA}/\sqrt{\text{Hz}}$	
Input Voltage							
V_{CM}	Common-Mode Voltage Range	—	$(V_-) - 0.1$	—	$(V_+) + 0.1$	V	
CMRR	Common-Mode Rejection Ratio	$(V_-) - 0.1\text{V} < V_{CM} < (V_+) + 0.1\text{V}$ $T_A = -40^\circ\text{C}$ to $+125^\circ\text{C}$	90	120	—	dB	
Input Capacitance							
—	Differential	—	—	2	—	pF	
—	Common-Mode	—	—	4	—	pF	
Open-Loop Gain							
A_{OL}	Open-Loop Voltage Gain	$(V_-) + 100\text{mV} < V_O < (V_+) - 100\text{mV}$ $R_L = 10\text{k}\Omega$, $T_A = -40^\circ\text{C}$ to $+125^\circ\text{C}$	106	130	—	dB	
Frequency Response							
GBW	Gain-Bandwidth Product	$C_L = 100\text{pF}$	—	350	—	kHz	
SR	Slew Rate	$G = +1$	—	0.12	—	$\text{V}/\mu\text{s}$	
Output							
—	Voltage Output Swing from Rail	Positive Rail $R_L = 10\text{k}\Omega$	$T_A = +25^\circ\text{C}$	—	30	50	mV
			$T_A = -40^\circ\text{C}$ to $+125^\circ\text{C}$	—	—	70	
		Negative Rail $R_L = 10\text{k}\Omega$	$T_A = +25^\circ\text{C}$	—	10	50	
			$T_A = -40^\circ\text{C}$ to $+125^\circ\text{C}$	—	—	70	
I_{SC}	Short-Circuit Current	Source Current	—	5	—	mA	
		Sink Current	—	25	—	mA	
—	Open-Loop Output Impedance	$f = 350\text{kHz}$, $I_O = 0\text{A}$	—	2	—	$\text{k}\Omega$	
Power Supply							
V_S	Specified Voltage Range	—	1.8	—	5.5	V	
I_Q	Quiescent Current	$I_O = 0\text{A}$, $T_A = +25^\circ\text{C}$	—	17	28	μA	
		$I_O = 0\text{A}$, $T_A = -40^\circ\text{C}$ to $+125^\circ\text{C}$	—	—	30		
t_{ON}	Turn-On Time	$V_S = 5\text{V}$	—	100	—	μs	

Note: 7. 300-hour life test at $+150^\circ\text{C}$ demonstrated randomly distributed variation of approximately $1\mu\text{V}$. This parameter is guaranteed by design and characterization, not by testing.

Typical Performance Characteristics

Supply Current vs. Temperature

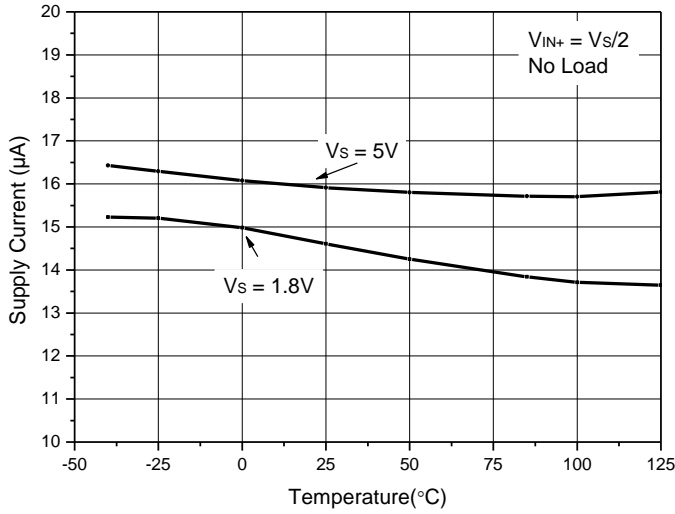

Input Offset Voltage vs. Input Common Mode Voltage

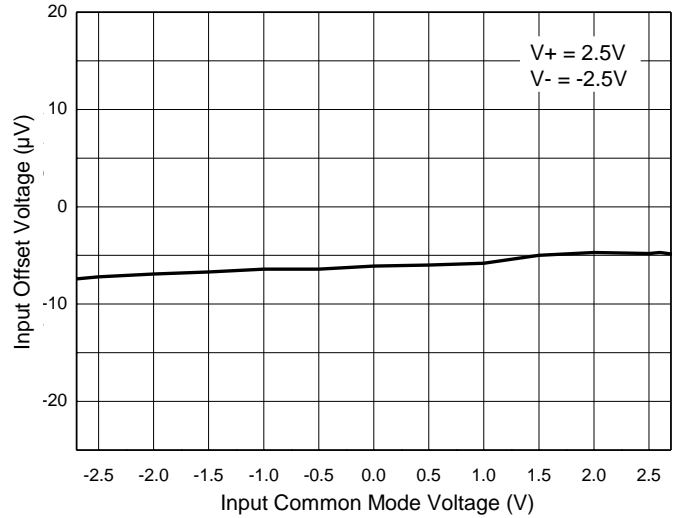

Output Characteristics-Sourcing Current

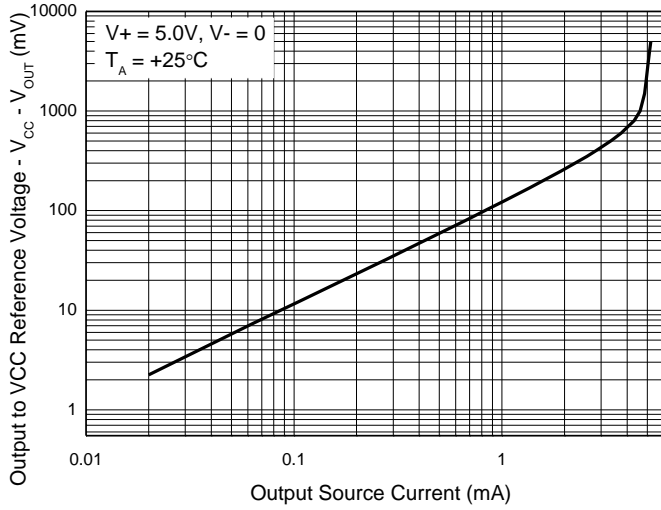

Output Characteristics-Sinking Current

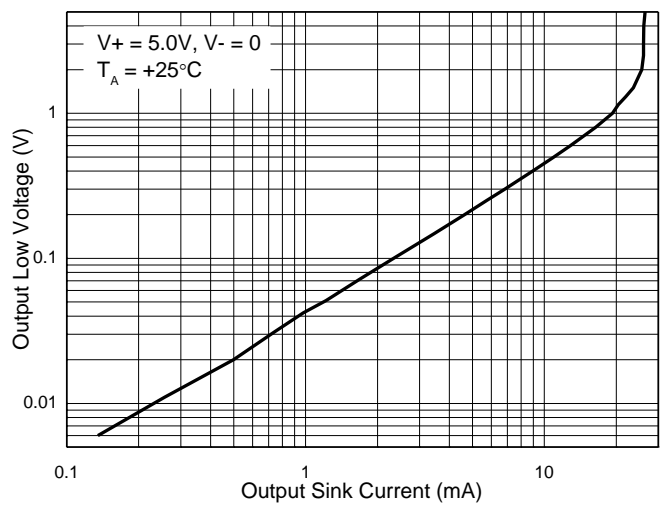

Large Signal Step Response

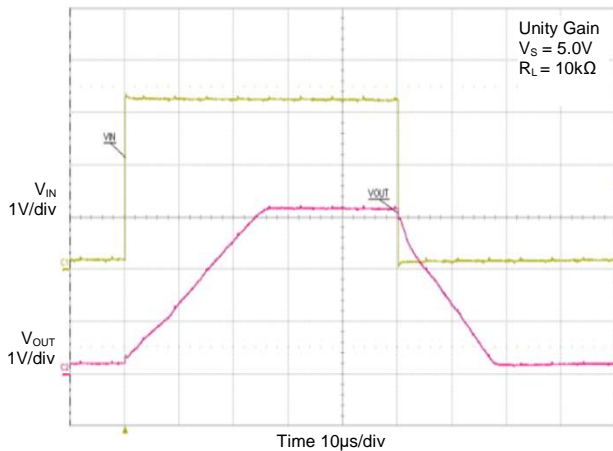

Small Signal Step Response

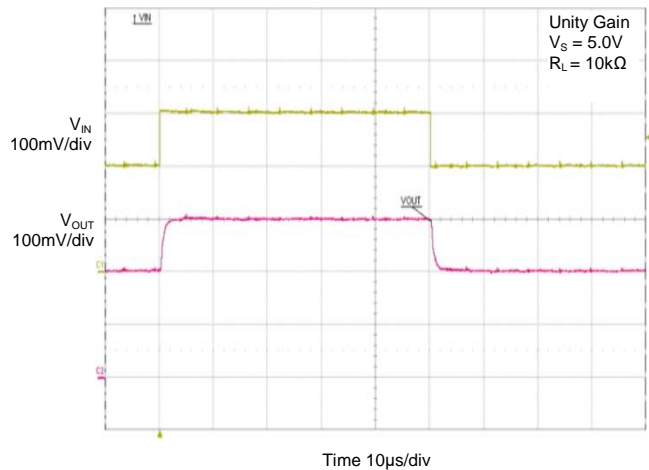

Typical Performance Characteristics (continued)

Small Signal Step Response, $C_L = 100\text{pF}$

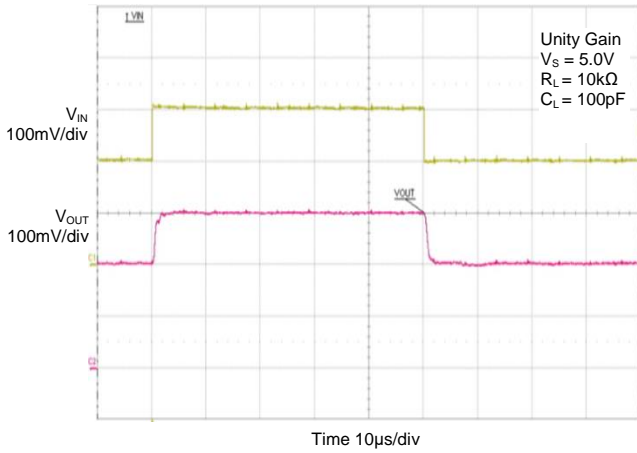

Small Signal Step Response, $C_L = 220\text{pF}$

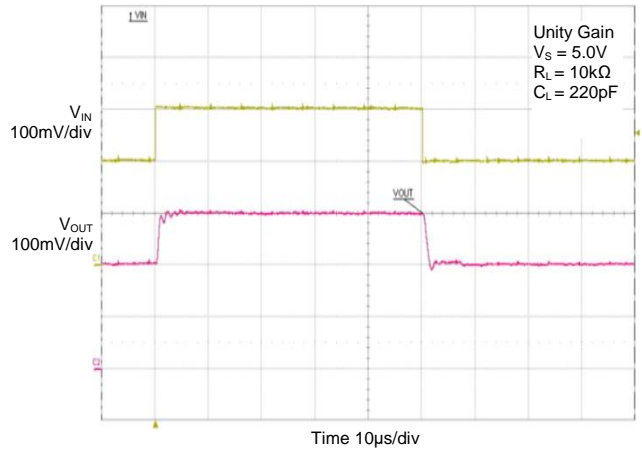

Negative Overvoltage Response

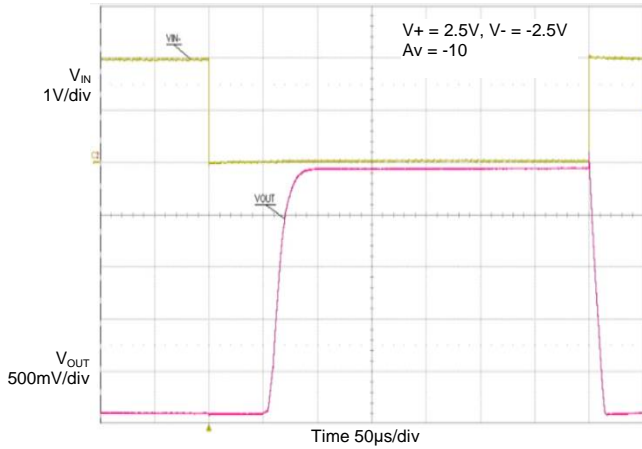

Positive Overvoltage Response

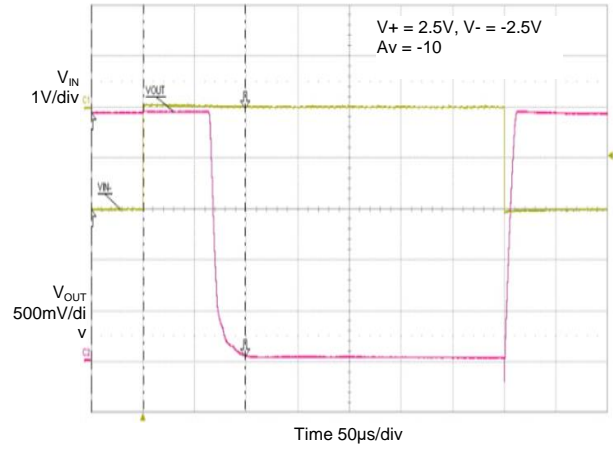

Output Voltage Swing from Rail

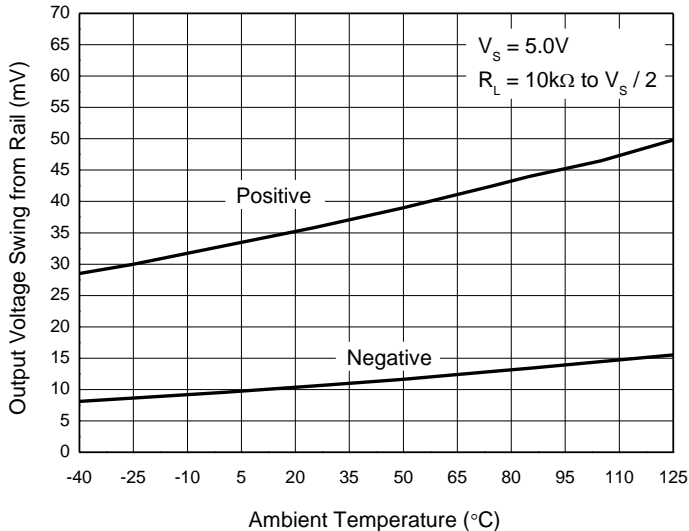

Voltage Noise Spectral Density

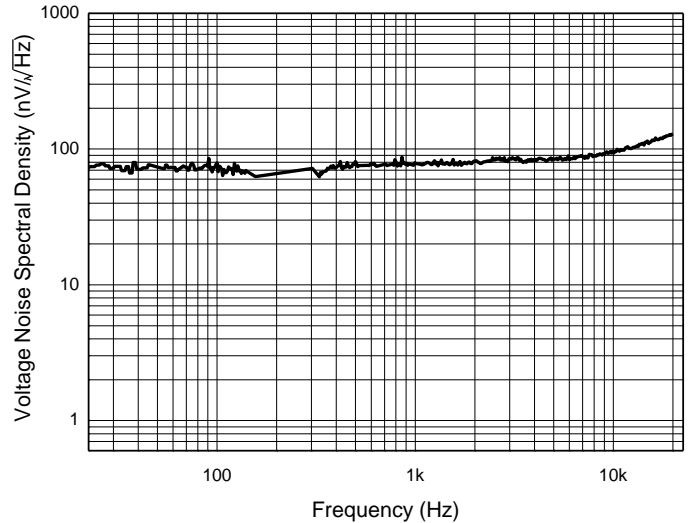

Typical Performance Characteristics (continued)

Frequency Response (Gain and Phase Margin)

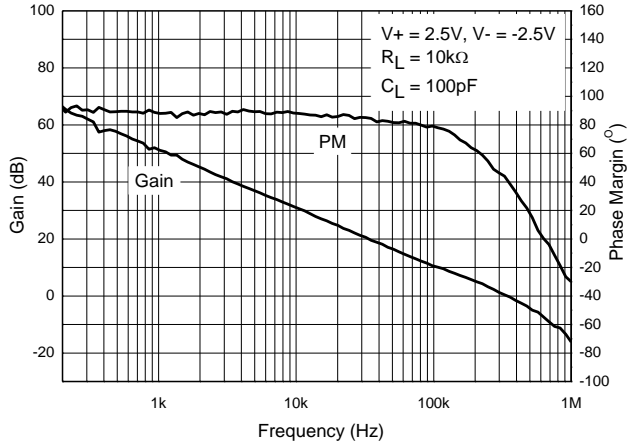

PSRR (Power Supply Rejection Ratio) vs. Frequency

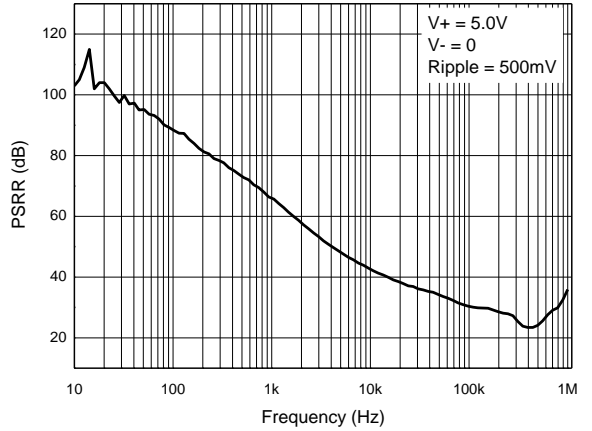

Application Information

Overview

The AS333 is low power, zero-drift, high precision, rail-to-rail input and output operational amplifier, which adopts chopper-stabilized function circuits to provide the advantage of minimizing input offset voltage and offset voltage drift over time and temperature. Its input common-mode voltage range extends 0.1V beyond the supply rails to allow for sensing near ground or system V_{DD} . The device operates from a single-supply voltage as low as 1.8V, is unity-gain stable, has no 1/f noise, has good PSRR and CMRR performance. These features make the part suitable for a wide range of general-purpose applications, especially for low-power high precision ones.

Low Input Referred Noise

The device AS333 is chopper stabilized amplifier, the flicker noise is reduced greatly because of this technique. The zero-drift chopper-stabilized amplifiers are especially suited for accurate, high-gain amplification at lower frequencies. In general, they do not exhibit the higher bandwidth of linear operational amplifier, and the location of their clock frequency establishes a practical frequency limit on signal fidelity. This makes performance at low frequencies especially important, and the chopper-stabilized architecture further contributes to low frequency usefulness by eliminating the classic linear operational amplifier 1/f input voltage noise. Many high gain sensor applications are at low frequencies, making zero-drift amplifiers a natural choice for this function.

Below plots compared conventional amplifier voltage noise density behavior and zero-drift amplifier's, this 1/f noise elimination in zero-drift amplifier allows the AS333 to have much lower noise at DC and low frequency compared to conventional low noise amplifier.

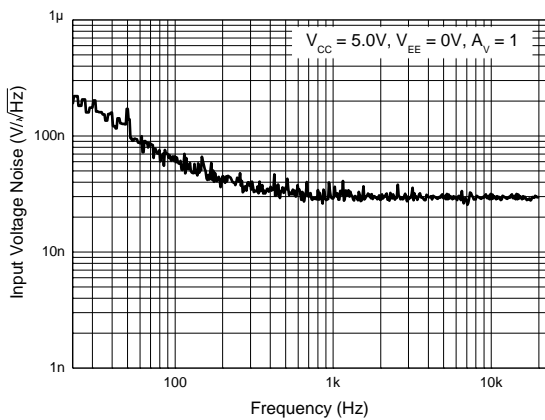

Figure 1. Input Voltage Noise in Conventional Amplifier

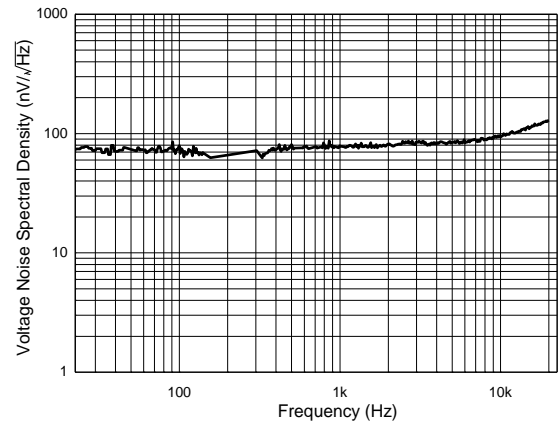

Figure 2. Input Voltage Noise in Zero-Drift Amplifier

Driving a Capacitive Load

The AS333 can directly drive 200pF in unity-gain without oscillation. The unity-gain follower is the most sensitive configuration to capacitive loading. Capacitive loading directly on the output terminal can decrease the device's phase margin leading to high frequency ringing or oscillation.

To drive a heavier capacitive load, the circuit in Figure 3 can be used. The resistor R_{NULL} and C_L form a pole to increase stability by adding more phase margin to the system. The bigger R_{NULL} resistor value the more stable V_{OUT} is. Figure 4 and Figure 5 are AS333 output pulse response waveforms with and without R_{NULL} 330Ω for load conditions $C_L = 470pF$ and $R_L = 10kΩ$.

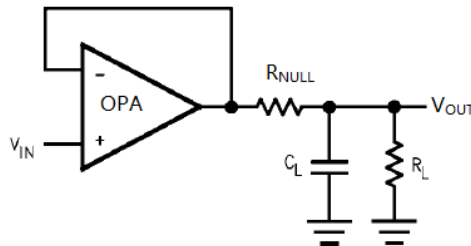

Figure 3. Capacitive Load with R_{NULL}

Application Information (continued)

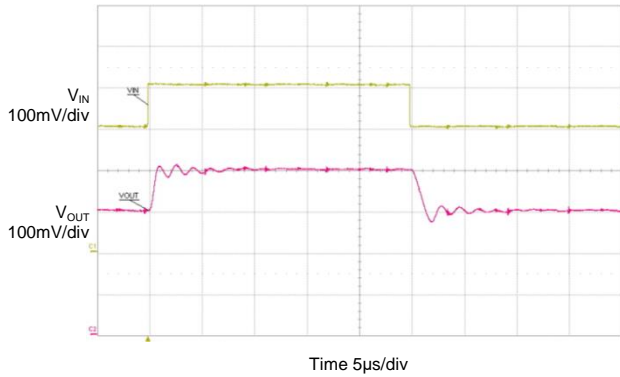

Figure 4. Test Result Without R_{NULL}

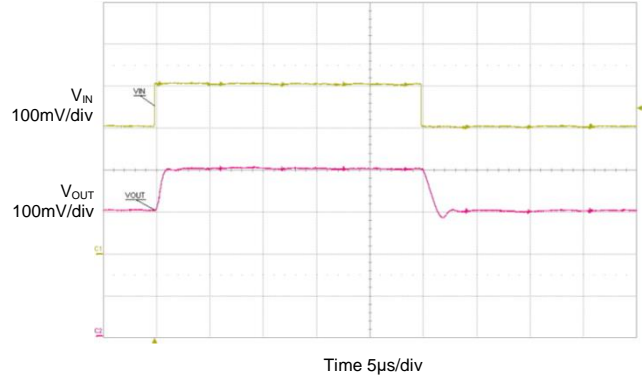

Figure 5. Test Result with R_{NULL} 330Ω

To reduce output ringing and overshoot, another way is to use the RC snubber circuit, shown in Figure 6, it does allow the amplifier to drive larger values of capacitance while maintaining a minimum of overshoot and ringing. Figure 7 shows AS333 test result for capacitive load 470pF with snubber circuit.

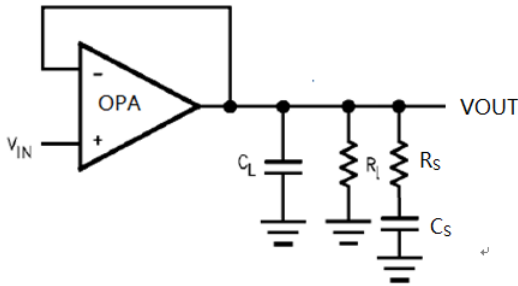

Figure 6. The RC Snubber Circuit

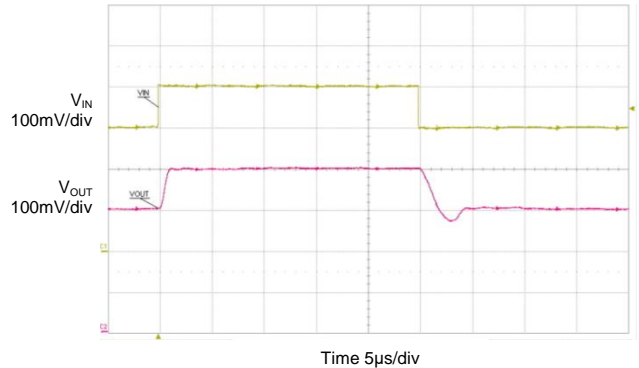

Figure 7. Test Result with Snubber Circuit

Differential Amplifier for Bridged Circuits

Sensors to measure strain, pressure, and temperature are often configured in a Wheatstone bridge circuit as shown in Figure 8. In the measurement, the voltage change that is produced is relatively small and needs to be amplified before going into an ADC. Precision amplifiers are recommended in these types of applications due to their high gain, low noise, and low offset voltage.

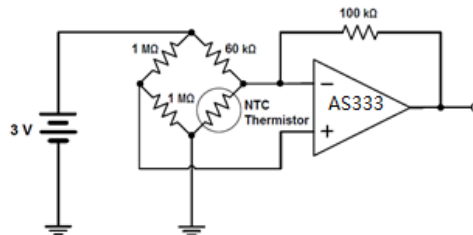
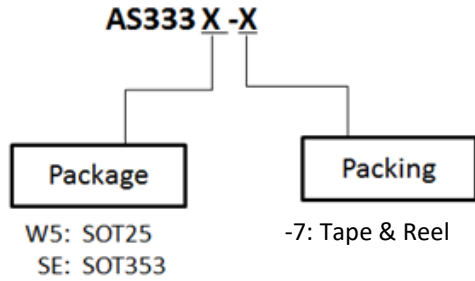

Figure 8. Bridge Circuit Amplification

Ordering Information



Orderable Part Number	Part Number Suffix	Package Code	Package	Packing	
				Quantity	Carrier
AS333W5-7	-7	W5	SOT25	3,000	Tape & Reel
AS333SE-7	-7	SE	SOT353	3,000	Tape & Reel

Marking Information

(1) SOT25 and SOT353

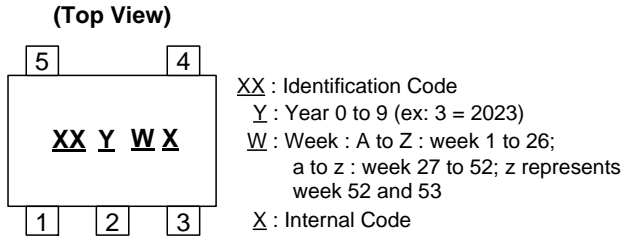

Part Number	Package	Identification Code
AS333SE-7	SOT353	PF
AS333W5-7	SOT25	PG

Package Outline Dimensions

Please see <http://www.diodes.com/package-outlines.html> for the latest version.

SOT25

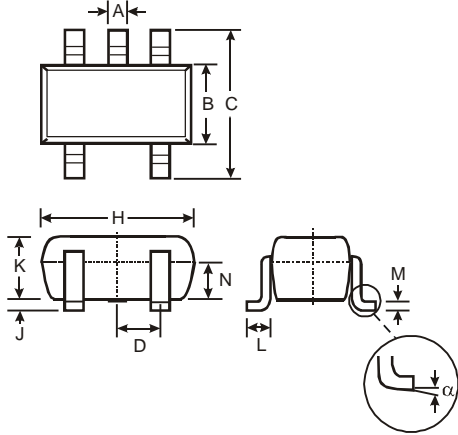

SOT25			
Dim	Min	Max	Typ
A	0.35	0.50	0.38
B	1.50	1.70	1.60
C	2.70	3.00	2.80
D	-	-	0.95
H	2.90	3.10	3.00
J	0.013	0.10	0.05
K	1.00	1.30	1.10
L	0.35	0.55	0.40
M	0.10	0.20	0.15
N	0.70	0.80	0.75
α	0°	8°	-
All Dimensions in mm			

SOT353

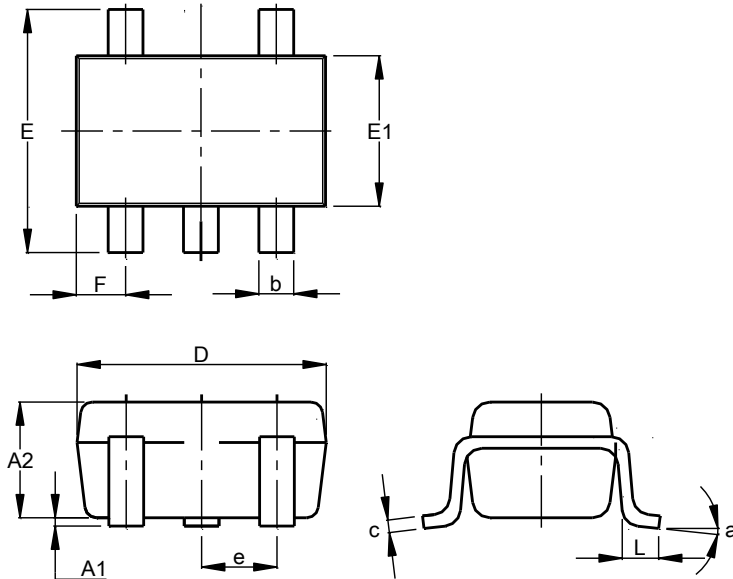

SOT353			
Dim	Min	Max	Typ
A1	0.00	0.10	0.05
A2	0.90	1.00	0.95
b	0.10	0.30	0.25
c	0.10	0.22	0.11
D	1.80	2.20	2.15
E	2.00	2.20	2.10
E1	1.15	1.35	1.30
e	0.650 BSC		
F	0.40	0.45	0.425
L	0.25	0.40	0.30
a	0°	8°	--
All Dimensions in mm			

Suggested Pad Layout

Please see <http://www.diodes.com/package-outlines.html> for the latest version.

SOT25

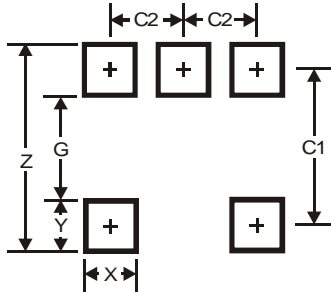

Dimensions	Value
Z	3.20
G	1.60
X	0.55
Y	0.80
C1	2.40
C2	0.95

SOT353

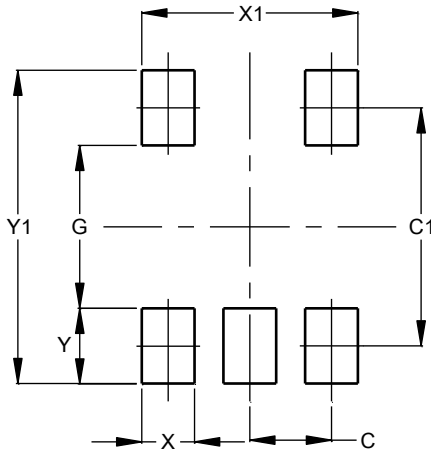

Dimensions	Value (in mm)
C	0.650
C1	1.900
G	1.300
X	0.420
X1	1.720
Y	0.600
Y1	2.500

Mechanical Data

SOT25

- Moisture Sensitivity: Level 1 per J-STD-020
- Terminals: Finish – Matte Tin Plated Leads, Solderable per MIL-STD-202, Method 208 (e3)
- Weight: 0.015 grams (Approximate)

SOT353

- Moisture Sensitivity: Level 1 per J-STD-020
- Terminals: Finish – Matte Tin Plated Leads, Solderable per MIL-STD-202, Method 208 (e3)
- Weight: 0.006 grams (Approximate)

IMPORTANT NOTICE

1. DIODES INCORPORATED (Diodes) AND ITS SUBSIDIARIES MAKE NO WARRANTY OF ANY KIND, EXPRESS OR IMPLIED, WITH REGARDS TO ANY INFORMATION CONTAINED IN THIS DOCUMENT, INCLUDING, BUT NOT LIMITED TO, THE IMPLIED WARRANTIES OF MERCHANTABILITY, FITNESS FOR A PARTICULAR PURPOSE OR NON-INFRINGEMENT OF THIRD PARTY INTELLECTUAL PROPERTY RIGHTS (AND THEIR EQUIVALENTS UNDER THE LAWS OF ANY JURISDICTION).
2. The Information contained herein is for informational purpose only and is provided only to illustrate the operation of Diodes' products described herein and application examples. Diodes does not assume any liability arising out of the application or use of this document or any product described herein. This document is intended for skilled and technically trained engineering customers and users who design with Diodes' products. Diodes' products may be used to facilitate safety-related applications; however, in all instances customers and users are responsible for (a) selecting the appropriate Diodes products for their applications, (b) evaluating the suitability of Diodes' products for their intended applications, (c) ensuring their applications, which incorporate Diodes' products, comply the applicable legal and regulatory requirements as well as safety and functional-safety related standards, and (d) ensuring they design with appropriate safeguards (including testing, validation, quality control techniques, redundancy, malfunction prevention, and appropriate treatment for aging degradation) to minimize the risks associated with their applications.
3. Diodes assumes no liability for any application-related information, support, assistance or feedback that may be provided by Diodes from time to time. Any customer or user of this document or products described herein will assume all risks and liabilities associated with such use, and will hold Diodes and all companies whose products are represented herein or on Diodes' websites, harmless against all damages and liabilities.
4. Products described herein may be covered by one or more United States, international or foreign patents and pending patent applications. Product names and markings noted herein may also be covered by one or more United States, international or foreign trademarks and trademark applications. Diodes does not convey any license under any of its intellectual property rights or the rights of any third parties (including third parties whose products and services may be described in this document or on Diodes' website) under this document.
5. Diodes' products are provided subject to Diodes' Standard Terms and Conditions of Sale (<https://www.diodes.com/about/company/terms-and-conditions/terms-and-conditions-of-sales/>) or other applicable terms. This document does not alter or expand the applicable warranties provided by Diodes. Diodes does not warrant or accept any liability whatsoever in respect of any products purchased through unauthorized sales channel.
6. Diodes' products and technology may not be used for or incorporated into any products or systems whose manufacture, use or sale is prohibited under any applicable laws and regulations. Should customers or users use Diodes' products in contravention of any applicable laws or regulations, or for any unintended or unauthorized application, customers and users will (a) be solely responsible for any damages, losses or penalties arising in connection therewith or as a result thereof, and (b) indemnify and hold Diodes and its representatives and agents harmless against any and all claims, damages, expenses, and attorney fees arising out of, directly or indirectly, any claim relating to any noncompliance with the applicable laws and regulations, as well as any unintended or unauthorized application.
7. While efforts have been made to ensure the information contained in this document is accurate, complete and current, it may contain technical inaccuracies, omissions and typographical errors. Diodes does not warrant that information contained in this document is error-free and Diodes is under no obligation to update or otherwise correct this information. Notwithstanding the foregoing, Diodes reserves the right to make modifications, enhancements, improvements, corrections or other changes without further notice to this document and any product described herein. This document is written in English but may be translated into multiple languages for reference. Only the English version of this document is the final and determinative format released by Diodes.
8. Any unauthorized copying, modification, distribution, transmission, display or other use of this document (or any portion hereof) is prohibited. Diodes assumes no responsibility for any losses incurred by the customers or users or any third parties arising from any such unauthorized use.
9. This Notice may be periodically updated with the most recent version available at <https://www.diodes.com/about/company/terms-and-conditions/important-notice>

The Diodes logo is a registered trademark of Diodes Incorporated in the United States and other countries.
All other trademarks are the property of their respective owners.
© 2023 Diodes Incorporated. All Rights Reserved.

www.diodes.com

Looking for pricing, stock, or lifecycle information?

Click below to explore more details on WIN SOURCE:

- ⊖ [View AS333W5-7 on WIN SOURCE](#)
- ⊖ [Diodes Incorporated Information](#)

Optimize Your Supply Chain with WIN SOURCE Solutions

- ✓ Global Sourcing Solution
- ✓ Obsolete Management
- ✓ Cost Control Management
- ✓ Shortage Management
- ✓ Alternative Solution
- ✓ Excess Inventory Management