

CMOS FIFO Register

4 Bits X 16 Words

High-Voltage Types (20-Volt Rating)

■ CD40105B is a low-power first-in-first-out (FIFO) "elastic" storage register that can store 16 4-bit words. It is capable of handling input and output data at different shifting rates. This feature makes it particularly useful as a buffer between asynchronous systems.

Each word position in the register is clocked by a control flip-flop, which stores a marker bit. A "1" signifies that the position's data is filled and a "0" denotes a vacancy in that position. The control flip-flop detects the state of the preceding flip-flop and communicates its own status to the succeeding flip-flop. When a control flip-flop is in the "0" state and sees a "1" in the preceding flip-flop, it generates a clock pulse that transfers data from the preceding four data latches into its own four data latches and resets the preceding flip-flop to "0". The first and last control flip-flops have buffered outputs. Since all empty locations "bubble" automatically to the input end, and all valid data ripple through to the output end, the status of the first control flip-flop (DATA-IN READY) indicates if the FIFO is full, and the status of the last flip-flop (DATA-OUT READY) indicates if the FIFO contains data. As the earliest data are removed from the bottom of the data stack (the output end), all data entered later will automatically propagate (ripple) toward the output.

Loading Data — Data can be entered whenever the DATA-IN READY (DIR) flag is high, by a low to high transition on the SHIFT-IN (SI) input. This input must go low momentarily before the next word is accepted by the FIFO. The DIR flag will go low momentarily, until the data have been trans-

Features:

- Independent asynchronous inputs and outputs
- 3-state outputs
- Status indicators on input and output
- Standardized, symmetrical output characteristics
- 100% tested for quiescent current at 20 V
- 5-V, 10-V, and 15-V parametric ratings
- Maximum input current of 1 μ A at 18 V over full package-temperature range; 100 nA at 18 V and 25°C
- Noise margin (over full package-temperature range): 1 V at $V_{DD} = 5$ V
2 V at $V_{DD} = 10$ V 2.5 V at $V_{DD} = 15$ V
- Meets all requirements of JEDEC Tentative Standard No. 13B, "Standard Specifications for Description of 'B' Series CMOS Devices"

ferred to the second location. The flag will remain low when all 16-word locations are filled with valid data, and further pulses on the SI input will be ignored until DIR goes high.

Unloading Data — As soon as the first word has rippled to the output, DATA-OUT READY (DOR) goes high, and data can be removed by a falling edge on the SO input. This falling edge causes the DOR signal to go low while the word on the output is dumped and the next word moves to the output. As long as valid data are available in the FIFO, the DOR signal will go high again signifying that the next word is ready at the output. When the FIFO is empty, DOR will remain low, and any further commands will be ignored until a "1" marker ripples down to the last control register,

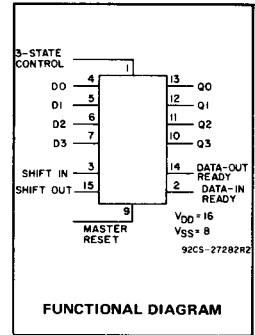

Applications:

- Bit rate smoothing
- CPU/terminal buffering
- Data communications
- Peripheral buffering
- Line printer input buffers
- Auto dialers
- CRT buffer memories
- Radar data acquisition

when DOR goes high. Unloading of data is inhibited while the 3-state control input is high. The 3-state control signal should not be shifted from high to low (data outputs turned on) while the SHIFT-OUT is at logic 0. This level change would cause the first word to be shifted out (unloaded) immediately and the data to be lost.

Cascading — The CD40105B can be cascaded to form longer registers simply by connecting the DIR to SO and DOR to SI. In the cascaded mode, a MASTER RESET pulse must be applied after the supply voltage is turned on. For words wider than 4 bits, the DIR and the DOR outputs must be gated together with AND gates. Their outputs drive the SI and SO inputs in parallel, if expanding is done in both directions (see Figs. 3 and 15).

3-State Outputs — In order to facilitate data busing, 3-state outputs are provided on the data output lines, while the load condition of the register can be detected by the state of the DOR output.

Master Reset — A high on the MASTER RESET (MR) sets all the control logic marker bits to "0". DOR goes low and DIR goes high. The contents of the data register are not changed, only declared invalid, and will be superseded when the first word is loaded. The shift-in must be low during Master Reset.

The CD40105B types are supplied in 16-lead hermetic dual-in-line ceramic packages (D and F suffixes), 16-lead dual-in-line plastic packages (E suffix), and in chip form (H suffix).

MAXIMUM RATINGS, Absolute-Maximum Values:

DC SUPPLY-VOLTAGE RANGE, (V_{DD})	
Voltages referenced to V_{SS} Terminal)	-0.5V to +20V
INPUT VOLTAGE RANGE, ALL INPUTS	-0.5V to $V_{DD} + 0.5V$
DC INPUT CURRENT, ANY ONE INPUT	± 10 mA
POWER DISSIPATION PER PACKAGE (P_D):	
For $T_A = -55^\circ\text{C}$ to $+100^\circ\text{C}$	500mW
For $T_A = +100^\circ\text{C}$ to $+125^\circ\text{C}$	Derate Linearly at 12mW/ $^\circ\text{C}$ to 200mW
DEVICE DISSIPATION PER OUTPUT TRANSISTOR	
FOR $T_A = \text{FULL PACKAGE-TEMPERATURE RANGE (All Package Types)}$	100mW
OPERATING-TEMPERATURE RANGE (T_A)	-55°C to $+125^\circ\text{C}$
STORAGE TEMPERATURE RANGE (T_{stg})	-65°C to $+150^\circ\text{C}$
LEAD TEMPERATURE (DURING SOLDERING):	
At distance 1/16 \pm 1/32 inch (1.59 \pm 0.79mm) from case for 10s max	+265°C

3
COMMERCIAL CMOS
HIGH VOLTAGE ICs

CD40105B Types

RECOMMENDED OPERATING CONDITIONS at 25°C, Except as Noted

For maximum reliability, nominal operating conditions should be selected so that operation is always within the following ranges:

CHARACTERISTIC	V _{DD} (V)	LIMITS		UNITS
		Min.	Max.	
Supply-Voltage Range (For T _A = Full Package - Temperature Range)	—	3	18	V
Shift-In or Shift-Out Rate	5 10 15	—	1.5 3 4	MHz
Shift-In Pulse Width (Pin 3)	5 10 15	200 80 60	— — —	ns
Shift-Out Pulse Width (Pin 15)	5 10 15	180 75 55	— — —	ns
Shift-In or Shift-Out Rise Time	5 10 15	— — —	15 15 15	μs
Shift-In Fall Time	5 10 15	— — —	15 15 15	μs
Shift-Out Fall Time	5 10 15	— — —	15 5 5	μs
Data Hold Time	5 10 15	350 150 120	— — —	ns
Master Reset Pulse Width	5 10 15	220 90 60	— — —	ns

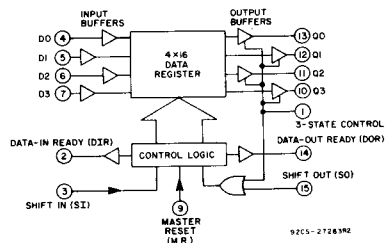
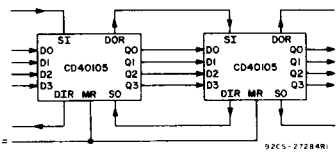

Fig. 2 - CD40105B functional block diagram.



*MASTER RESET pulse must be applied when cascading by 16 N-bits.

Fig. 3 - Expansion, 4-bits wide-by-16 N-bits long.

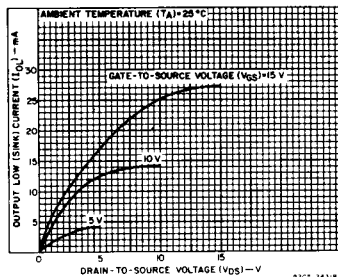

Fig. 4 - Typical output low (sink) current characteristics.

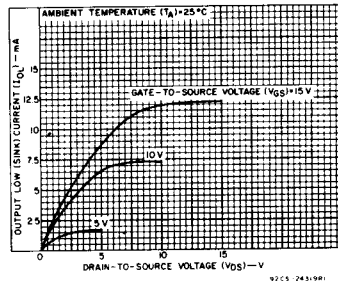

Fig. 5 - Minimum output low (sink) current characteristics.

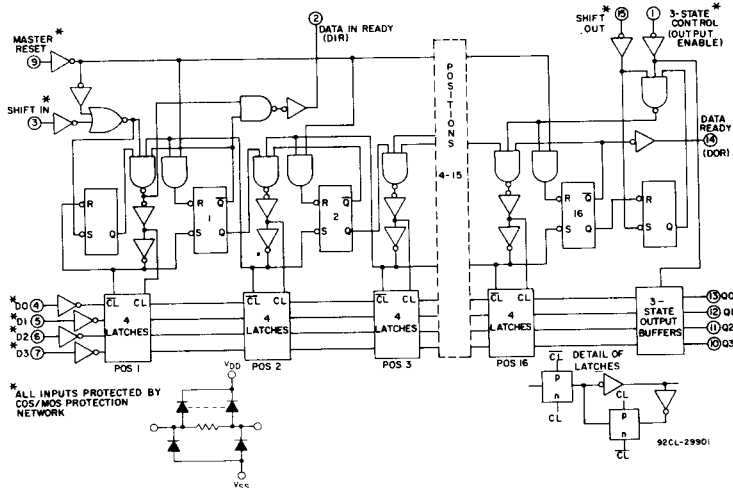

Fig. 1 - Logic diagram for the CD40105B.

CD40105B Types

STATIC ELECTRICAL CHARACTERISTICS

CHARACTERISTIC	CONDITIONS			LIMITS AT INDICATED TEMPERATURES (°C)							UNITS
	V _O (V)	V _{IN} (V)	V _{DD} (V)	-55	-40	+85	+125	+25			
								Min.	Typ.	Max.	
Quiescent Device Current, I _{DD} Max.	-	0,5	5	5	5	150	150	-	0,04	5	μA
	-	0,10	10	10	10	300	300	-	0,04	10	
	-	0,15	15	20	20	600	600	-	0,04	20	
	-	0,20	20	100	100	3000	3000	-	0,08	100	
Output Low (Sink) Current I _{OL} Min.	0,4	0,5	5	0,64	0,61	0,42	0,36	0,51	1	-	mA
	0,5	0,10	10	1,6	1,5	1,1	0,9	1,3	2,6	-	
	1,5	0,15	15	4,2	4	2,8	2,4	3,4	6,8	-	
Output High (Source) Current, I _{OH} Min.	4,6	0,5	5	-0,64	-0,61	-0,42	-0,36	-0,51	-1	-	mA
	2,5	0,5	5	-2	-1,8	-1,3	-1,15	-1,6	-3,2	-	
	9,5	0,10	10	-1,6	-1,5	-1,1	-0,9	-1,3	-2,6	-	
	13,5	0,15	15	-4,2	-4	-2,8	-2,4	-3,4	-6,8	-	
Output Voltage: Low-Level, V _{OL} Max.	-	0,5	5	0,05				-	0	0,05	V
	-	0,10	10	0,05				-	0	0,05	
	-	0,15	15	0,05				-	0	0,05	
Output Voltage: High-Level, V _{OH} Min.	-	0,5	5	4,95				4,95	5	-	V
	-	0,10	10	9,95				9,95	10	-	
	-	0,15	15	14,95				14,95	15	-	
Input Low Voltage V _{IL} Max.	0,5, 4,5	-	5	1,5				-	-	1,5	V
	1,9	-	10	3				-	-	3	
	1,5, 13,5	-	15	4				-	-	4	
Input High Voltage, V _{IH} Min.	0,5, 4,5	-	5	3,5				3,5	-	-	V
	1,9	-	10	7				7	-	-	
	1,5, 13,5	-	15	11				11	-	-	
Input Current I _{IN} Max.	-	0,18	18	±0,1	±0,1	±1	±1	-	±10 ⁻⁵	±0,1	μA
3-State Output Leakage Current I _{OUT} Max.	0,18	0,18	18	±0,4	±0,4	±12	±12	-	±10 ⁻⁴	±0,4	μA

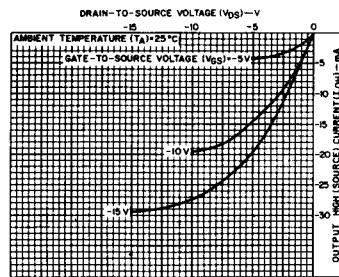

Fig. 6 - Typical output high (source) current characteristics.

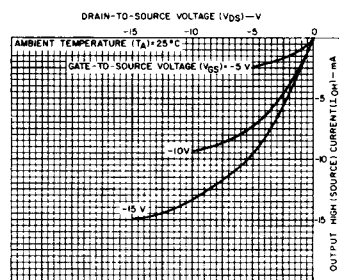

Fig. 7 - Minimum output high (source) current characteristics.

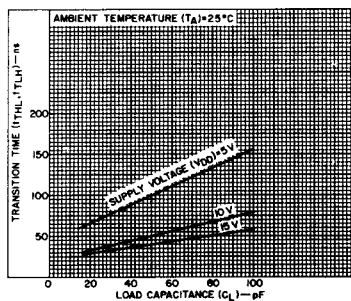

Fig. 8 - Typical transition time as a function of load capacitance.

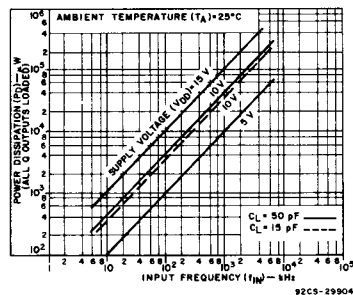

Fig. 9 - Typical dynamic power dissipation as a function of frequency.

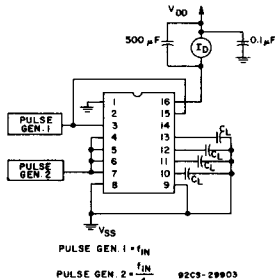

Fig. 10 - Dynamic power dissipation test circuit.

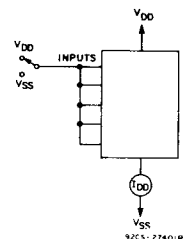

Fig. 11 - Quiescent-device-current test circuit.

COMMERCIAL CMOS HIGH VOLTAGE ICs

CD40105B Types

DYNAMIC ELECTRICAL CHARACTERISTICS at $T_A = 25^\circ\text{C}$;
 Input $t_r, t_f = 20\text{ ns}$, $C_L = 50\text{ pF}$, $R_L = 200\text{ k}\Omega$

CHARACTERISTIC	TEST CONDITIONS	LIMITS			UNITS	
		V_{DD} (V)	Min.	Typ.		Max.
Propagation Delay Time: Shift-Out or Reset to Data-Out Ready, t_{PHL}		5	—	185	370	ns
		10	—	90	180	
		15	—	65	130	
Shift-In to Data-In Ready, t_{PHL}		5	—	160	320	ns
		10	—	65	130	
		15	—	45	90	
Shift-Out to Q_n Out, t_{PHL}, t_{PLH}		5	—	210	420	ns
		10	—	100	205	
		15	—	70	150	
3-State Control to Data Out Note 1 t_{PZH}, t_{PZL}		5	—	140	280	ns
		10	—	60	120	
		15	—	40	80	
t_{PHZ}, t_{PLZ}		5	—	100	200	ns
		10	—	50	100	
		15	—	40	80	
Ripple-Through Delay Input to Output, t_{PLH}		5	—	2	4	μs
		10	—	1	2	
		15	—	0.7	1.4	
Transition Time, t_{THL}, t_{TLH}		5	—	100	200	ns
		10	—	50	100	
		15	—	40	80	
Maximum Shift-In or Shift-Out Rate, f_I		5	1.5	3	—	MHz
		10	3	6	—	
		15	4	8	—	
Minimum Shift-In Pulse Width, (Pin 3) t_W		5	—	100	200	ns
		10	—	40	80	
		15	—	30	60	
Minimum Shift-Out Pulse Width, (Pin 15) t_{WL}		5	—	90	180	ns
		10	—	35	75	
		15	—	25	55	
Maximum Shift-In or Shift-Out Rise Time, t_r		5	—	—	15	μs
		10	—	—	15	
		15	—	—	15	
Maximum Shift-In Fall Time, t_f		5	—	—	15	μs
		10	—	—	15	
		15	—	—	15	
Maximum Shift-Out Fall Time, t_f		5	—	—	15	μs
		10	—	—	5	
		15	—	—	5	
Minimum Data Setup Time, t_{SU}		5	—	—	0	ns
		10	—	—	0	
		15	—	—	0	
Minimum Data Hold Time, t_H		5	—	175	350	ns
		10	—	75	150	
		15	—	60	120	
Data-In Ready Pulse Width, t_{WL} (Pin 2)		5	—	260	520	ns
		10	—	100	200	
		15	—	70	140	
Data-Out Ready Pulse Width, t_{WL} (Pin 14)		5	—	220	440	ns
		10	—	90	180	
		15	—	65	130	
Minimum Master Reset Pulse Width, t_{WH}		5	—	100	200	ns
		10	—	45	90	
		15	—	30	60	
Input Capacitance C_{IN}	(Any Input)	—	—	5	7.5	pF

Note 1: The Output Enable Line (Pin 1) should be low for limits specified.

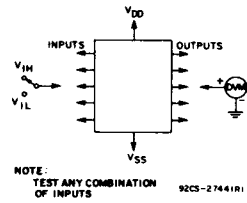

Fig. 12 — Input-voltage test circuit.

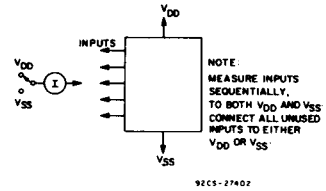
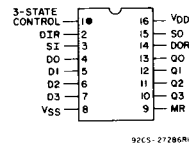

Fig. 13 — Input current test circuit.



TERMINAL ASSIGNMENT

CD40105B Types

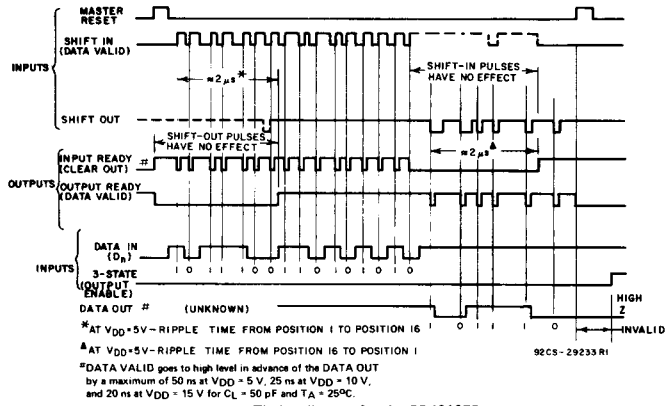

Fig. 14 - Timing diagram for the CD40105B.

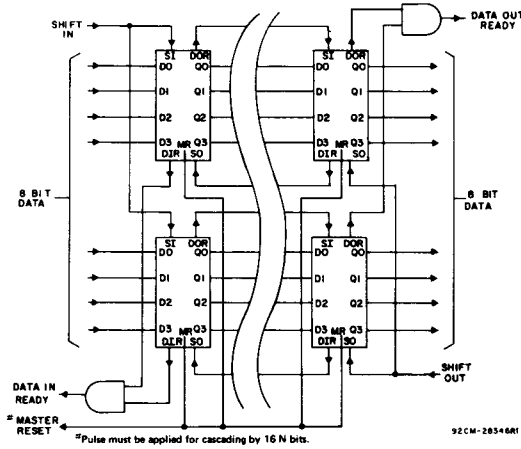
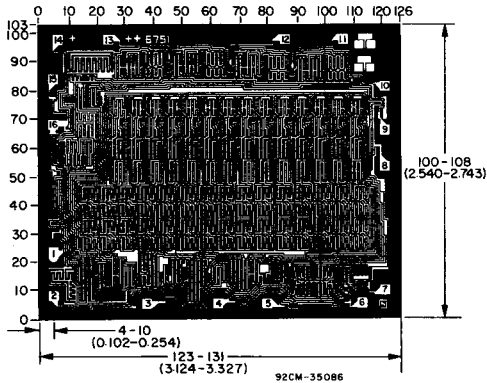

Fig. 15 - Expansion, 8-bits-wide-by-16 N-bits long using CD40105.



Dimensions in parentheses are in millimeters and are derived from the basic inch dimensions as indicated. Grid graduations are in mils (10^{-3} inch).





Looking for pricing, stock, or lifecycle information?

Click below to explore more details on WIN SOURCE:

 [View CD40105BEX on WIN SOURCE](#)

 [Harris Corporation](#) Information

Optimize Your Supply Chain with WIN SOURCE Solutions

-  Global Sourcing Solution
-  Obsolete Management
-  Cost Control Management
-  Shortage Management
-  Alternative Solution
-  Excess Inventory Management