

## Bluetooth<sup>®</sup> Low Energy SoC

### Features

- Bluetooth smart 5.0 Bluetooth Low Energy compliant
- 256 Kbytes embedded Flash memory
- UART/SPI/I<sup>2</sup>C interface supported
- Integrated crystal oscillator operates with 32 MHz external crystal
- Temperature sensor supported
- 31 general purpose I/O (GPIO) pins for IS1870 SoC and 15 GPIO pins for IS1871 SoC
- Supports 4-channel pulse-width modulation (PWM) for IS1870 SoC and 1-channel PWM for IS1871 SoC
- Supports 12-bit ADC (ENOB=10 or 8 bits) for battery and voltage detection
- 16-channel ADC for IS1870 SoC and 6-channel ADC for IS1871 SoC are provided
- AES-CMAC hardware engine
- Beacon support
- Low power consumption
- Compact size:
  - IS1871: 4 mm x 4 mm 32QFN package
  - IS1870: 6 mm x 6 mm 48QFN package

### Radio Frequency (RF)/Analog Features

- ISM band: 2.402 GHz to 2.480 GHz operation
- Channels: 0 to 39
- Rx sensitivity: -90 dBm in Bluetooth Low Energy mode
- Tx power: 0 dBm (typical)
- Received Signal Strength Indicator (RSSI) monitor

### Operating Conditions

- Operating voltage: 1.9V to 3.6V
- Operating temperature: -40°C to +85°C

### Applications

- Internet of Things (IoT)
- Wearable, fitness or healthcare
- Weighing scale
- Proximity/Find Me services
- Secure payment
- Digital beacons
- Consumer appliances or home automation
- Industrial

### Packages

Type	IS1870	IS1871
Pin count	48	32
I/O pins (up to)	31	15
Contact/lead pitch	0.4	0.4
Dimensions	6x6x0.9	4x4x0.9
Package	QFN48	QFN32

**Note:** All dimensions are in millimeters (mm) unless specified.

# IS1870/71

---

NOTES:

## Table of Contents

1.0 Device Overview .....	5
2.0 System Block Details .....	13
3.0 Electrical Characteristics .....	17
4.0 Package Information .....	21
5.0 Reflow Profile and Storage Condition .....	27
6.0 Ordering Guide .....	31
Appendix A: Reference Circuit .....	33
Appendix B: Layout Guidelines .....	37
Appendix C: Revision History .....	39

## TO OUR VALUED CUSTOMERS

It is our intention to provide our valued customers with the best documentation possible to ensure successful use of your Microchip products. To this end, we will continue to improve our publications to better suit your needs. Our publications will be refined and enhanced as new volumes and updates are introduced.

If you have any questions or comments regarding this publication, please contact the Marketing Communications Department via E-mail at [docerrors@microchip.com](mailto:docerrors@microchip.com) or fax the **Reader Response Form** in the back of this data sheet to (480) 792-4150. We welcome your feedback.

### Most Current Data Sheet

To obtain the most up-to-date version of this data sheet, please register at our Worldwide Web site at:

<http://www.microchip.com>

You can determine the version of a data sheet by examining its literature number found on the bottom outside corner of any page. The last character of the literature number is the version number, (e.g., DS30000000A is version A of document DS30000000).

### Errata

An errata sheet, describing minor operational differences from the data sheet and recommended workarounds, may exist for current devices. As device/documentation issues become known to us, we will publish an errata sheet. The errata will specify the revision of silicon and revision of document to which it applies.

To determine if an errata sheet exists for a particular device, please check with one of the following:

- Microchip's Worldwide Web site; <http://www.microchip.com>
- Your local Microchip sales office (see last page)

When contacting a sales office, please specify which device, revision of silicon and data sheet (include literature number) you are using.

### Customer Notification System

Register on our web site at [www.microchip.com](http://www.microchip.com) to receive the most current information on all of our products.

# IS1870/71

---

NOTES:

## 1.0 DEVICE OVERVIEW

The IS1870/71 SoC contains a 2.4 GHz transceiver, a Power Management Unit (PMU), Microchip's Bluetooth Low Energy software stack and an RF power amplifier.

The default factory configuration is designed to work with a host MCU to provide the user with an embedded Bluetooth Low Energy design setup for the IoT application domain.

**Note:** Flexibility of the IS1870/71 SoC enables the user to work in a host-less implementation. In this configuration, the user can embed a full application into the IS1870/71 SoC. Contact your local Microchip representative for further guidance on obtaining this setup.

The IS1870/71 SoC provides:

- Simple integration and programming
- Reduced development time
- Superior Bluetooth Low Energy solution with low-cost system
- Interoperability with Apple® iOS and Android™ OS
- Wide range of application support

With the default factory configuration, the IS1870/71 SoC supports Beacon technology, where the automation of Bluetooth Low Energy connection/control and cloud connectivity are common.

The IS1870/71 SoC is optimized to maintain a low power wireless connection. The low power consumption and flexible power management maximize the IS1870/71 SoC lifetime in battery operated devices. A wide operating temperature range enables its applications in indoor and outdoor environments (industrial temperature range is -40°C to +85°C).

The small form factor package size of the IS1870/71 SoC is designed for wearable applications. The solution providers can minimize the module size to meet the market requirements, which is commonly seen in the IoT application domain.

To operate in the 2.4 GHz ISM band radio, the IS1870/71 SoC is certified for the Bluetooth v5.0 core specification, including support for the enhanced throughput and the Federal Information Processing Standard (FIPS) compliant encryption support for secure data connections.

The IS1870/71 SoC integrates transceiver and base-band functions to decrease external components. Microchip provides free Bluetooth stack firmware to build an embedded Bluetooth Low Energy solution, using the IS1870/71 SoC.

# IS1870/71

Figure 1-1 illustrates a typical block diagram of the IS1870 SoC.

**FIGURE 1-1: BLOCK DIAGRAM OF THE IS1870 SOC**

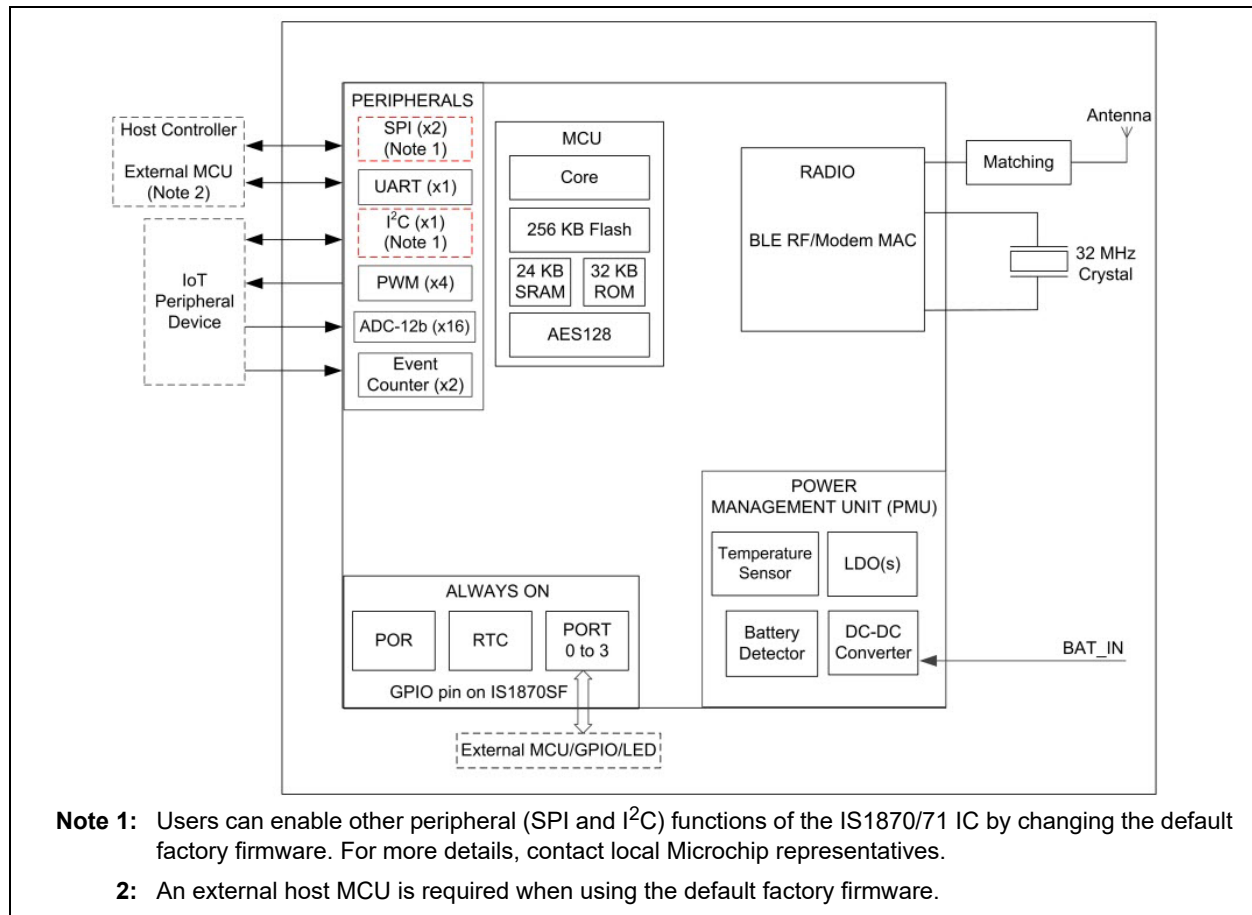

Figure 1-2 illustrates a typical block diagram of the IS1871 SoC-based system.

**FIGURE 1-2: IS1871 SOC-BASED SYSTEM BLOCK DIAGRAM**

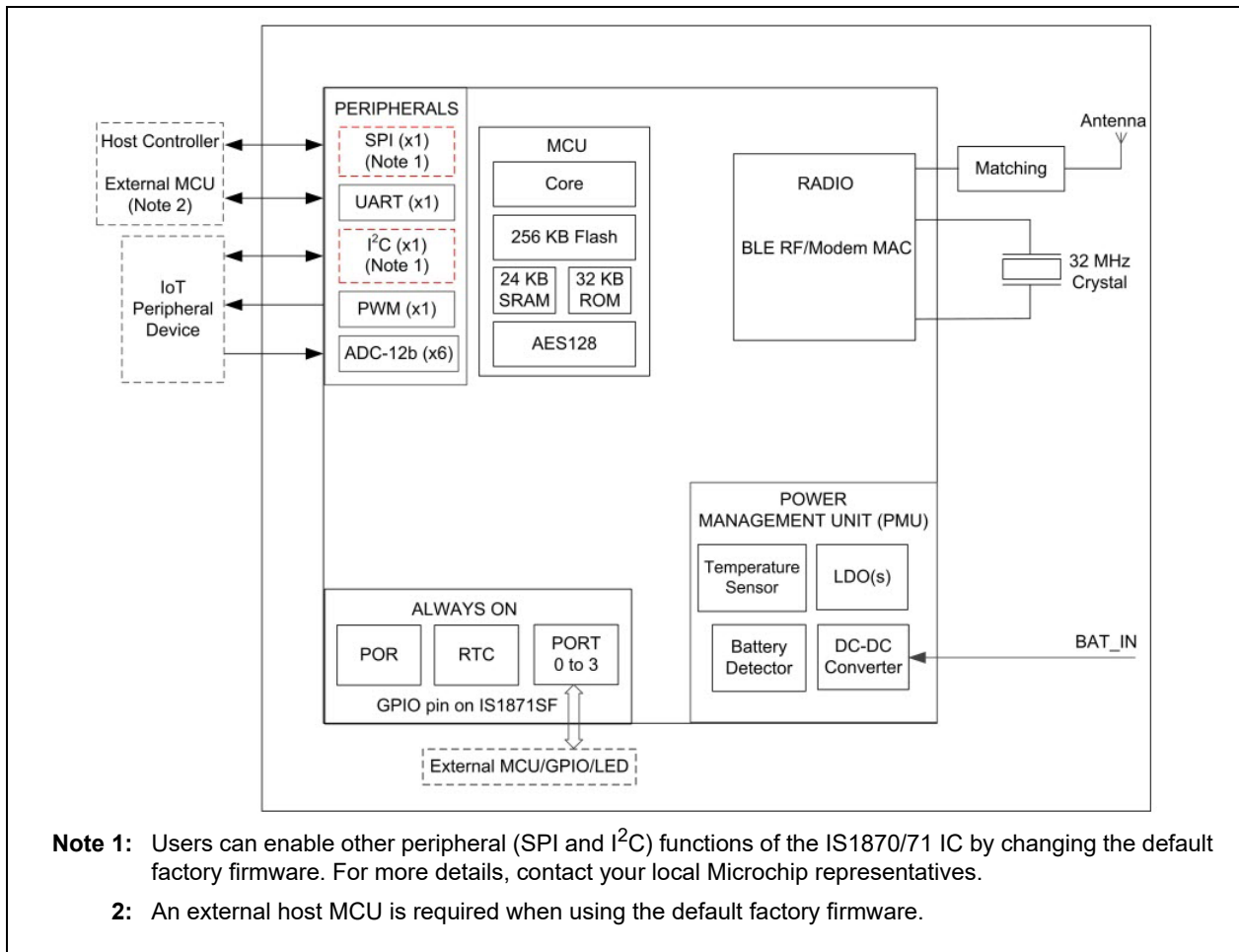

Table 1-1 provides the key features of the IS1870/71 SoC.

**TABLE 1-1: KEY FEATURES**

Features	IS1870	IS1871
UART	1	1
GPIO	31	15
12-bit ADC channels	16	6
PWM	4	1
SPI (see <b>Note 1</b> )	2	1
I <sup>2</sup> C (see <b>Note 1</b> )	1	1
Pins	48	32
Size	6x6x0.9 mm	4x4x0.9 mm
Event counter	2	0
AES-CMAC H/W engine	Yes	Yes

**Note 1:** To make these peripherals available to a designer, contact your local Microchip representative.

# IS1870/71

## Pin Description

Figure 1-3 and Figure 1-4 illustrate the IS1870 and IS1871 pin assignment details.

**FIGURE 1-3: IS1870 SOC PIN ASSIGNMENT**

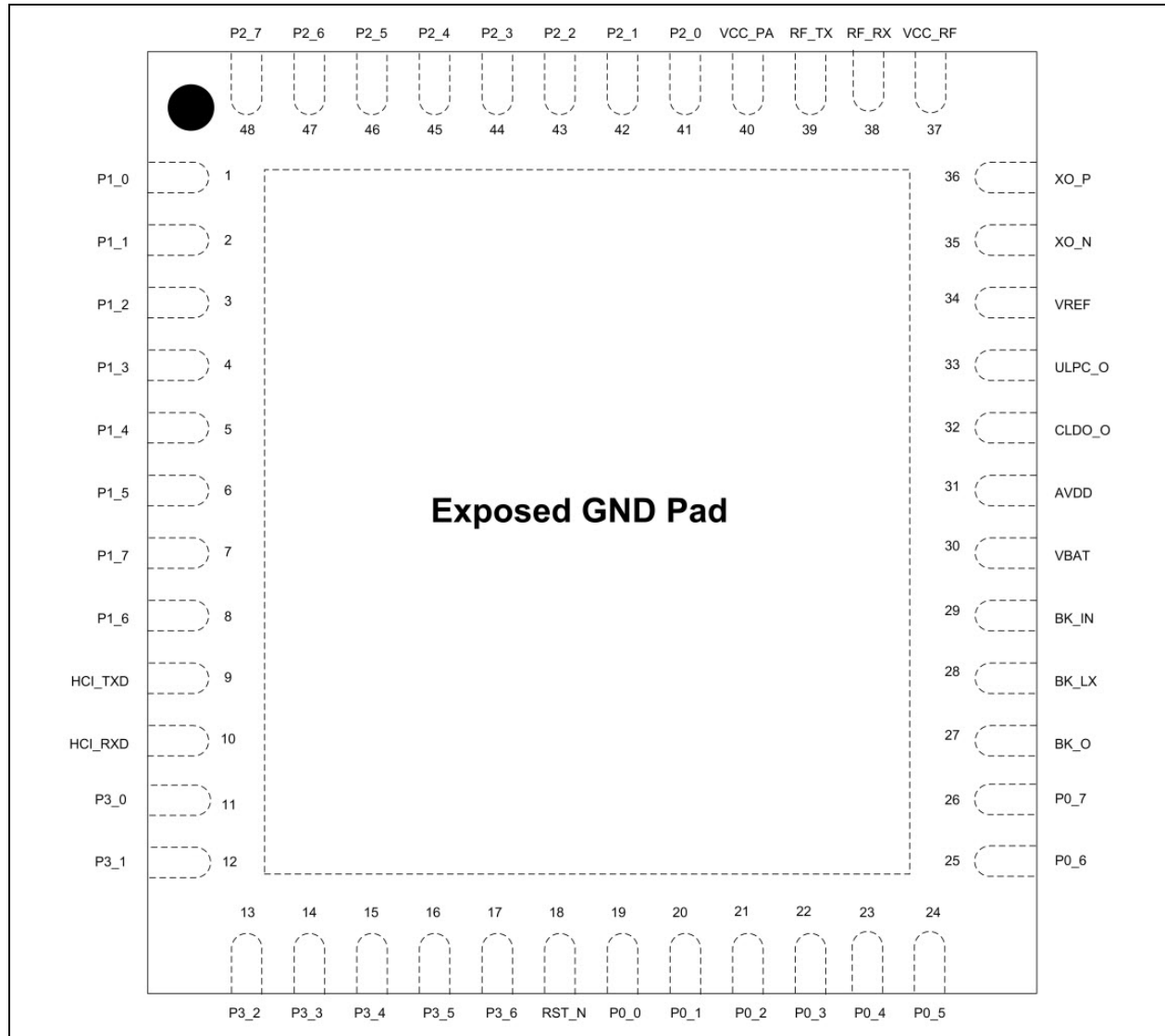

**FIGURE 1-4: IS1871 SOC PIN ASSIGNMENT**

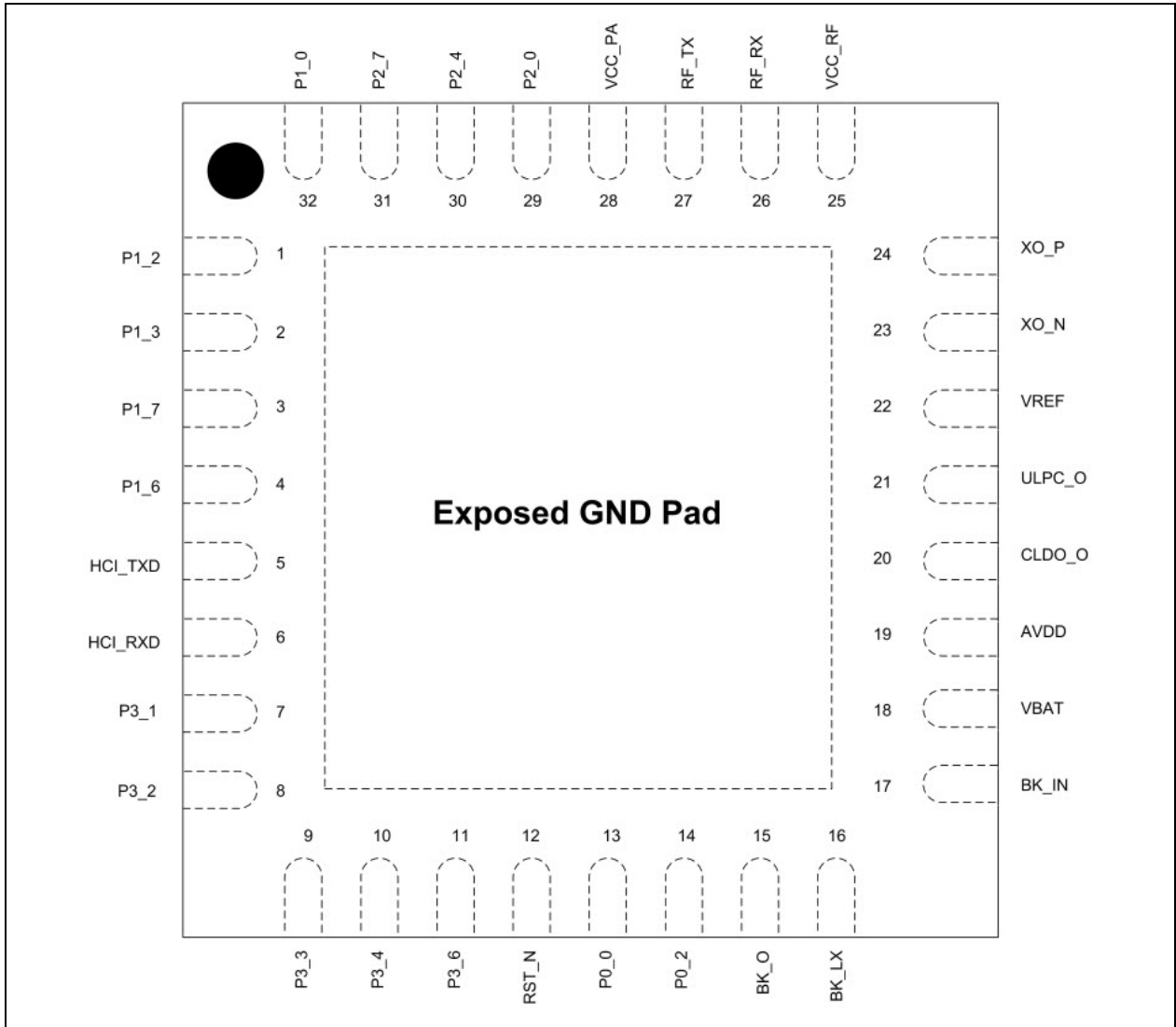

# IS1870/71

Table 1-2 provides the functions of the various pins in the IS1870/71 SoC.

**TABLE 1-2: IS1870/71 SOC PIN DESCRIPTION**

IS1870 Pin No.	IS1871 Pin No.	Pin Name	Type	Description
1	32	P1_0	DIO AI	GPIO: P1_0 ADC input: AD8 TX_CLS1: Class 1 RF Tx Control
2	—	P1_1	DIO AI DI	GPIO: P1_1 ADC input: AD9 SPI bus: MISO2: Second SPI bus (Central mode)
3	1	P1_2	DIO AI I/O	GPIO: P1_2 ADC input: AD10 I <sup>2</sup> C SCL
4	2	P1_3	DIO AI DIO	GPIO: P1_3 ADC input: AD11 I <sup>2</sup> C SDA
5	—	P1_4	DIO AI DI	GPIO: P1_4 ADC input: AD12 Event Counter
6	—	P1_5	DIO AI DI	GPIO: P1_5 ADC input: AD13 Event Counter
7	3	P1_7	DIO AO	GPIO: P1_7 External 32.768 kHz Crystal Output: XO32K
8	4	P1_6	DIO AI	GPIO: P1_6 External 32.768 kHz Crystal Input: XI32K
9	5	HCI_TXD	DO	HCI UART TXD
10	6	HCI_RXD	DI	HCI UART RXD
11	—	P3_0	DIO	GPIO: P3_0
12	7	P3_1	DIO DO	GPIO: P3_1 SPI bus: NCS, SPI Flash: CSN
13	8	P3_2	DIO DI	GPIO: P3_2 SPI bus: MISO, SPI Flash: SDO
14	9	P3_3	DIO DO	GPIO: P3_3 SPI bus: MOSI, SPI Flash: SDI
15	10	P3_4	DIO DO	GPIO: P3_4 SPI bus: SCLK, SPI Flash: SCK
16	—	P3_5	DIO AI	GPIO: P3_5 LED1
17	11	P3_6	DIO DO DO	GPIO: P3_6 UART flow-control RTS PWM0
18	12	RST_N	DI	External Reset
19	13	P0_0	DIO AI DI	GPIO: P0_0 ADC input: AD0 UART flow-control CTS
20	—	P0_1	DIO AI	GPIO: P0_1 ADC input: AD1

**Legend:** A = Analog      D = Digital      I = Input      O = Output      P = Power

**TABLE 1-2: IS1870/71 SOC PIN DESCRIPTION (CONTINUED)**

IS1870 Pin No.	IS1871 Pin No.	Pin Name	Type	Description
21	14	P0_2	DIO AI AI	GPIO: P0_2 ADC input: AD2 LED0
22	—	P0_3	DIO AI	GPIO:P0_3 ADC input: AD3
23	—	P0_4	DIO AI	GPIO:P0_4 ADC input: AD4
24	—	P0_5	DIO AI	GPIO:P0_5 ADC input: AD5
25	—	P0_6	DIO AI	GPIO:P0_6 ADC input: AD6
26	—	P0_7	DIO AI	GPIO:P0_7 ADC input: AD7
27	15	BK_O	P	1.55V buck regulator output. For internal use, do not connect to external devices)
28	16	BK_LX	P	1.55V buck regulator output. For internal use, do not connect to external devices
29	17	BK_IN	P	Buck input. Voltage Range: 1.9V to 3.6V
30	18	VBAT	P	Battery input. Voltage Range: 1.9V to 3.6V. Connect to BK_IN and a 10 $\mu$ F decoupling capacitor, as illustrated in <a href="#">Figure A-1</a> and <a href="#">Figure A-3</a> .
31	19	AVDD	P	Input of LDOs: CLDO, PALDO and RFLDO
32	20	CLDO_O	P	1.2V CLDO Output: Core-logic and memories supply, connect to 1 $\mu$ F (X5R/X7R) capacitor
33	21	ULPC_O	P	1.2V Programmable ULPC Output: Always On logic and retention memory supply (for internal use, do not connect to external devices)
34	22	VREF	P	PMU band-gap reference voltage output for LDOs and buck (for internal use, do not connect to external devices)
35	23	XO_N	A	32 MHz crystal input negative
36	24	XO_P	A	32 MHz crystal input positive
37	25	VCC_RF	P	Power input for VCO and RF (1.28V). Connect to 1 $\mu$ F (X5R/X7R) capacitor
38	26	Rx	AI	RF receive path
39	27	Tx	AO	RF transmit path
40	28	VCC_PA	P	Power supply for power amplifier (1.55V). Connect to 0.22 $\mu$ F X5R/X7R
41	29	P2_0	DIO	Mode Configuration H: Application mode L: Test mode
42	—	P2_1	DIO DO	GPIO: P2_1 PWM0
43	—	P2_2	DIO DO	GPIO: P2_2 PWM1
44	—	P2_3	DIO DO	GPIO: P2_3 PWM2

**Legend:** A = Analog      D = Digital      I = Input      O = Output      P = Power

# IS1870/71

TABLE 1-2: IS1870/71 SOC PIN DESCRIPTION (CONTINUED)

IS1870 Pin No.	IS1871 Pin No.	Pin Name	Type	Description
45	30	P2_4	DIO	GPIO: P2_4 TX_CLS1: Class 1 RF RX Control
46	—	P2_5	DIO AI DO	GPIO: P2_5 ADC input: AD15 PWM3
47	—	P2_6	DIO	P26
48	31	P2_7	DIO AI DO	GPIO: P27 ADC input: AD14 SPI bus: NCS2, second SPI bus (Central mode)

**Legend:** A = Analog      D = Digital      I = Input      O = Output      P = Power

## 2.0 SYSTEM BLOCK DETAILS

### 2.1 System Block Descriptions

This section provides a description of the blocks used in the IS1870/71 SoC.

#### 2.1.1 PMU

The IS1870/71 SoC includes a DC-DC converter and four LDOs. Microchip's Bluetooth Low Energy software stack is used for controlling and operating these LDOs

in various modes, controlling the amount of time the peak current is active, maximizing the battery life. The factory firmware enables the designer to perform the calibration for the internal LDOs to compensate for variations in the board design and other manufacturing-related artifacts.

Figure 2-1 illustrates the power tree diagram of the IS1870/71 SoC.

**FIGURE 2-1: IS1870/71 SOC POWER TREE DIAGRAM**

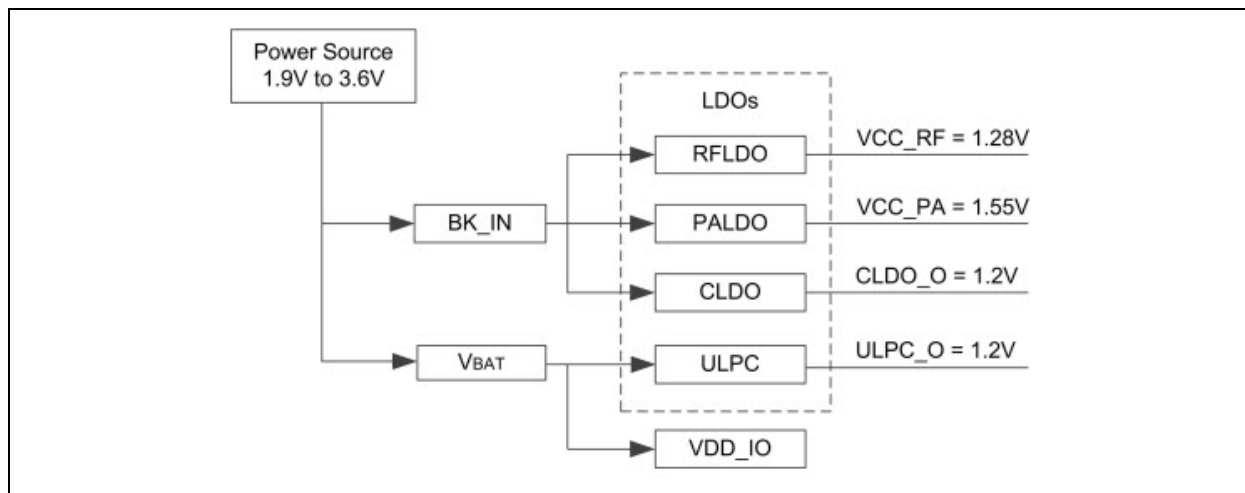

#### 2.1.2 ALWAYS ON LOGIC

Always On (AON) is the hardware-based state machine, which is controlled by Microchip's Bluetooth stack. Together, the software and hardware logic maintain the power-up, power-down and low power sequences of the IS1870/71 SoC, by providing optimal device performance. It includes an RTC timer and I/O detector to wake-up the system from Power-Saving mode using time out or external general I/O transition. This allows the SoC to run in Power-Saving mode while maintaining an active connection with a peer device and minimizing power consumption.

#### 2.1.3 RF

This SoC is controlled by Microchip's Bluetooth stack, which contains an on-chip RF circuit, a controller and a modulator (Tx)/demodulator (Rx). The Tx is used to control the synthesizer's phase and output power and modulate the data based on the Bluetooth Low Energy specifications. The Rx is used to decode the Bluetooth signal and optimize the performance, such as IQ-imbalance, suppress DC and flick noise. It is also used to compensate the frequency drift and offset, and filter out interference to maximize receiver sensitivity.

#### 2.1.4 MCU

Microchip provides the Bluetooth Low Energy software stack, which runs on the IS1870/71 SoC's internal 8051 core. The stack resides in a combination of ROM, RAM and embedded Flash. The software stack is responsible for scheduling the Bluetooth Low Energy tasks and for processing the Bluetooth Low Energy protocol and profiles.

# IS1870/71

## 2.2 System Block Specification

The following are the system block specifications.

**Note:** The system blocks which make up the IS1870/71 SoC are listed below. However, some of the blocks used in the IS1870/71 SoC are controlled by the default factory firmware and are not available to the designer.

### 2.2.1 RF

- Bluetooth BT5.0 LE compliant SoC
- Frequency: 2.402 GHz to 2.480 GHz
- Programmable transmit output power up to +3 dBm maximum
- -25 dBm minimum Tx power to search nearby devices
- -90 dBm typical receiver power sensitivity
- Digital RSSI indicator (-50 dBm to -90 dBm)
- -40°C to +85°C Bluetooth Low Energy RF certified

### 2.2.2 PMU

- Operating battery input voltage range: 1.9V to 3.6V
- 1.28V RFLDO: RF IP power supply
- 1.55V PALDO: RF Tx power amplify supply
- 1.2V CLDO: Core-logic and memories supply
- 1.55V DC-DC switching buck converter
- 1.2V programmable ULPC to supply AON-logic and retention memory
- AON-logic to control power-up, power-down and wake-up procedures
- Internal 32 kHz ( $\pm 250$  ppm) ultra-low power oscillator
- Power-on Reset

### 2.2.3 MCU

- 8051 core with scalable clock
- ROM: 32 KB
- Main SRAM: 24 KB
- Embedded Flash: 256 KB for Device Firmware Upgrade (DFU) and run-time data storage

**Note:** The Microchip provided Bluetooth Low Energy stack uses a portion of the available memory listed above. With the default factory firmware, the amount of memory used is fixed and the free memory is not available to the designer. As it is expected, the application will reside in the external host MCU. For details on altering the default factory setup, please contact your local Microchip representative.

### 2.2.4 PERIPHERALS

- Flexible GPIO pin configuration
- ADC:
  - 0V to 3.6V, 12-bit SDM-ADC with 16-channel (IS1870) or 6-Channel (IS1871) hybrid-I/O (Multi-Function). It can be configured as ADC or GPIO input
- Internal 1.9V to 3.6V battery voltage monitor
- Precision Temperature Sensor (PTS) for ambient temperature detection
- 4 MHz clock-rate full duplex 4-wire SPI with 256 bytes buffer DMA
- HCI over UART up to 921600 bps with flow-control
- Two wire serial interface (compatible to I<sup>2</sup>C)

**Note:** This peripheral is not available with the default factory firmware. For details on altering this default factory setup, contact your local Microchip representative.

- Three wire serial interface (compatible to SPI)

**Note:** This peripheral is not available with the default factory firmware. For details on altering this default factory setup, please contact your local Microchip representative.

- GPIO pins with input internal pull up /Hi-Z selectable
- 24-bit low-power Real Time Counter (RTC) for background timer in Standby mode
- Watchdog timer
- Event Counter option (P1\_4 and P1\_5) provides capture/counter function to external events for frequency calculation. It provides 1K/32K/1M/16M clock rate option to count the frequency range from 60 Hz to 1 MHz. The continuous/one shot count mode can be selected
- Specific GPIO pins (P1\_6 and P1\_7) support external 32.768 kHz crystal option for RTC; however, the default from the factory is set to use the internal 32 kHz ultra low-power oscillator
- PWM:
  - 16-bit PWM design
  - Four Individual frequency and individual duty cycle channel outputs multiplexed with GPIO pins (P2\_1, P2\_2, P2\_3 and P2\_5)
  - Three clock source (32K, 1M and 16M) selections to program frequency range from 0.488 Hz to 8 MHz
  - Double buffers output compare registers and top register to avoid glitch
  - Two pair output configurable as inverse channel

## 2.3 Host MCU Interface Over UART

Figure 2-2 illustrates IS1870/71 SoC application block diagram. In the diagram the power supply (3.3V), UART interface and GPIO control and indication are listed.

**FIGURE 2-2: IS1870/71 SOC APPLICATION BLOCK DIAGRAM WITH MCU**

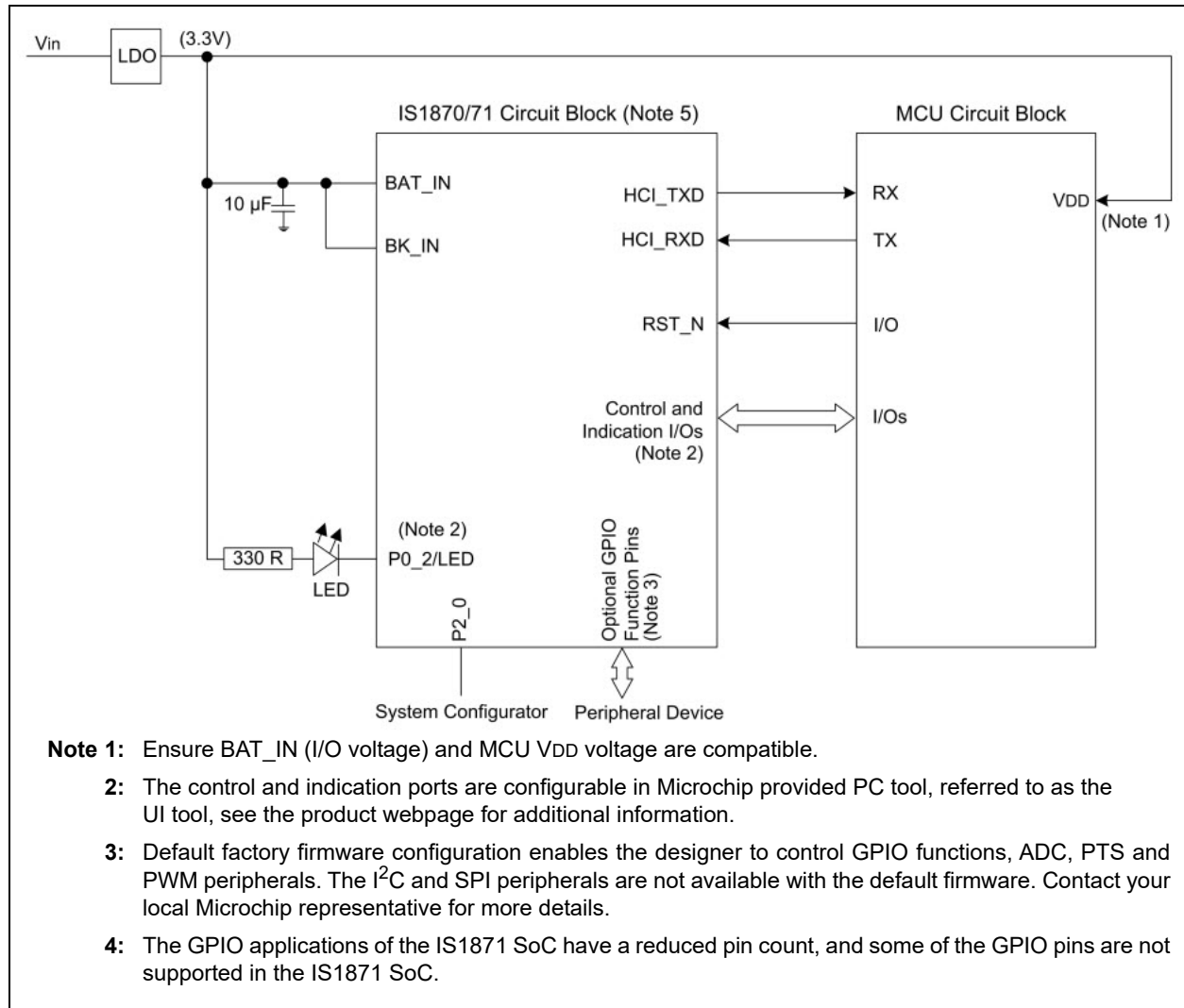

# IS1870/71

---

---

NOTES:

## 3.0 ELECTRICAL CHARACTERISTICS

This section provides an overview of the IS1870/71 SoC electrical characteristics. Additional information will be provided in future revisions of this document.

Absolute maximum ratings for the IS1870/71 devices are listed below. Exposure to the maximum rating conditions for extended periods may affect device reliability. Functional operation of the device at these or any other conditions, above the parameters indicated in the operation listings of this specification, is not implied.

### Absolute Maximum Ratings

(See Note)

Ambient temperature under bias with parts ending with 102 .....	-20°C to +70°C
Ambient temperature under bias with parts ending with 202 .....	-40°C to +85°C
Storage temperature .....	-40°C to +125°C
Voltage on VDD with respect to VSS .....	-0.3V to +3.6V
Voltage on any pin with respect to VSS .....	-0.3V to (VDD + 0.3V)
Maximum output current sunk by any I/O pin.....	12 mA
Maximum output current sourced by any I/O pin.....	12 mA
ESD (according to machine model, JEDEC EIA/JESD22-A115-C)	
Maximum output for all pins, excluding RF Tx pin .....	±200V
Maximum output for all pins .....	±150V
Maximum output (human-body model).....	±2 kV
Maximum output (charge-device model).....	±150V

**Note:** Stresses listed under “**Absolute Maximum Ratings**” may cause permanent damage to the device. This is a stress rating only. The functional operation of the device at those or any other conditions, and those indicated in the operation listings of this specification, is not implied. Exposure to maximum rating conditions for extended periods may affect device reliability.

# IS1870/71

Table 3-1 provides the recommended operating conditions of the IS1870/71 SoC.

**TABLE 3-1: RECOMMENDED OPERATING CONDITIONS**

Symbol	Min.	Typ.	Max.
<b>PMU</b>			
VDD (VBAT, BK_IN, AVDD)	1.9V	3.0V	3.6V
RST_N	1.9V	3.0V	3.6V
Other I/O	1.9V	—	3.6V
<b>GPIO</b>			
V <sub>IH</sub> (Input High Voltage)	0.7 V <sub>DD</sub>	—	V <sub>DD</sub>
V <sub>IL</sub> (Input Low Voltage)	V <sub>SS</sub>	—	0.3 V <sub>DD</sub>
V <sub>OH</sub> (Output High Voltage) (High drive, 12 mA)	0.8 V <sub>DD</sub>	—	V <sub>DD</sub>
V <sub>OL</sub> (Output Low Voltage) (High drive, 12 mA)	V <sub>SS</sub>	—	0.2 V <sub>DD</sub>
Pull up Resistance	34 kOhm	48 kOhm	74 kOhm
Pull down Resistance	29 kOhm	47 kOhm	86 kOhm
<b>Supply Current (see Note 1)</b>			
Tx mode peak current at V <sub>DD</sub> =3V, Tx=0 dBm, Buck mode	—	10 mA at +25°C	13 mA at +70°C/+85°C
Rx mode peak current at V <sub>DD</sub> =3V, Buck mode	—	10 mA at +25°C	13 mA at +70°C/+85°C
“Reduced current consumption” low power mode current (see Note 2)	—	60 μA at +25°C	—
“Shutdown” low power mode current (see Note 2)	1.0 μA	—	2.9 μA
<b>Analog-to-Digital Converter (ADC) for IS1870/71-202</b>			
Full scale (BAT_IN)	0V	3.0V	3.6V
Full scale (AD0 to AD15)	0V	—	3.6V
Operating Temperature Range	-40°C	25°C	85°C
Operating current	—	—	500 μA
DNL (ENOB 10-bit, ADC in 32 KHz Mode) (see Note 3 and 4)	-1	—	+1.5
INL (ENOB 10-bit, ADC in 32 KHz Mode) (see Note 3 and 4)	-2 LSB	—	+2 LSB
<b>Precise Temperature Sensor (PTS) for IS1870/71-202</b>			
Detect range	-40°C	—	+85°C
Digital Output	1160	—	2649
Resolution	—	12-bit/°C	—
Accuracy	-3°C	—	+3°C

**Note 1:** The current measurements are characterized across a sample of the BM70/71 module at room temperature (+25°C), unless otherwise noted.

**2:** For more details on “Reduced current consumption” or “Shutdown” low power modes, refer to the “*BM70/71 Bluetooth® Low Energy Module User’s Guide*” (DS50002542). This rating is part of the characterization of the default factory firmware.

**3:** ADC performance characterized with V1.06 production firmware across a set of IC’s are not tested during production.

**4:** Calculated DNL/INL values are determined using “Best Fit” method.

Table 3-2 provides the RF specifications of the IS1870/71 SoC.

**TABLE 3-2: RF SPECIFICATIONS**

Parameter	Min.	Typ.	Max.
<b>Transmitter</b>			
Frequency	2402 MHz	—	2480 MHz
Output Power	—	0 dBm	—
RF Power Control Range	-25 dBm	—	3 dBm
In-band Spurious (N±2)	—	-38.5 dBm	—
In-band Spurious (N±3)	—	-43.25 dBm	—
Modulation Characteristic - Frequency Deviation (see <b>Note 1</b> )	—	247 kHz	—
<b>Receiver</b>			
Frequency	2402 MHz	—	2480 MHz
Sensitivity Level (Interference active)	—	-90 dBm	—
Interference Performance	Co-channel	—	17 dB
	Adjacent ± 1 MHz	—	0 dB
	Adjacent ± 2 MHz	—	-25 dB
	Adjacent ≥ ± 3 MHz	—	-32 dB
Intermodulation Characteristic (n=3,4,5)	—	-37.5 dBm	—
Maximum Usable Level		0 dBm	

**Note 1:** Tested with a known pattern of '00001111'b being transmitted.

# IS1870/71

## 3.1 Current Consumption Details

### 3.1.1 Tx/Rx CURRENT CONSUMPTION DETAILS

Figure 3-1 illustrates the average current consumption of an advertising event during Bluetooth Low Energy operation of the IS1870/71 SoC.

The peak current of the VBAT input is 12 mA and the average current is around 230  $\mu$ A. In this example the advertising interval is 100 ms and current consumption is measured at 3.3V VBAT input.

FIGURE 3-1: AVERAGE CURRENT CONSUMPTION DURING ADVERTISING

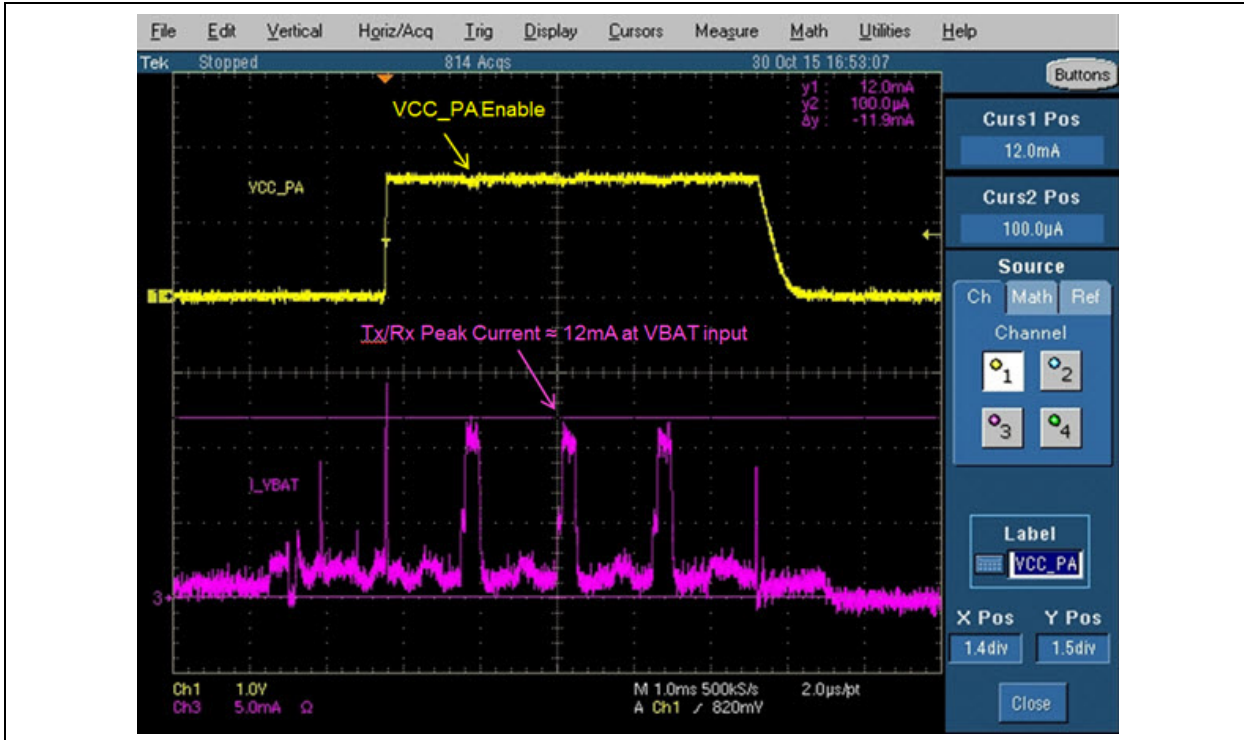

## 4.0 PACKAGE INFORMATION

Figure 4-1 through Figure 4-5 illustrate the package marking information of the IS1870SF IC.

### 4.1 48QFN, 6x6 mm SoC Outline (IS1870SF)

FIGURE 4-1: 48QFN, 6X6 MM PACKAGE INFORMATION (IS1870SF)

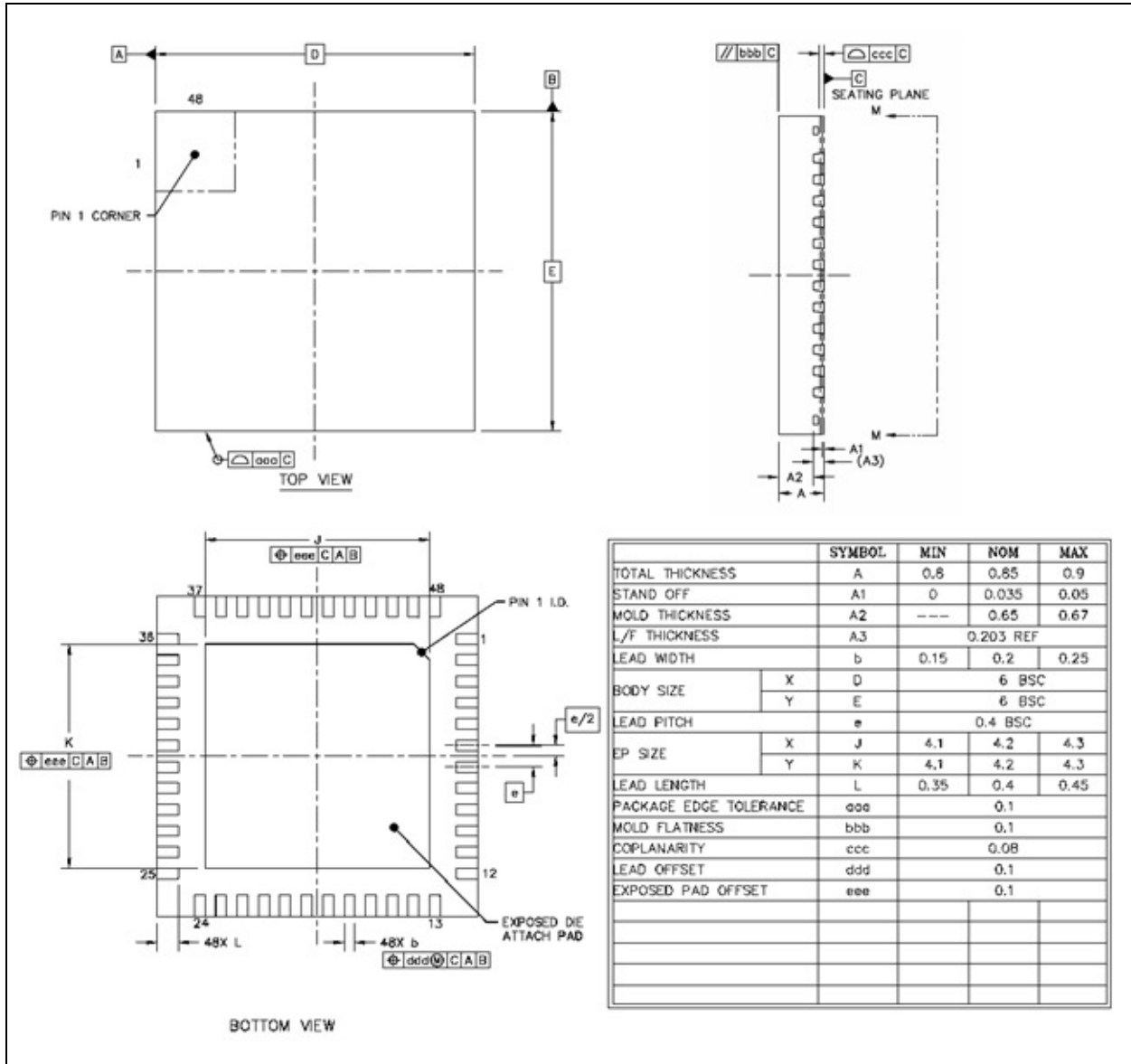



## 4.2 32QFN, 4x4 mm SoC Outline (IS1871SF)

FIGURE 4-3: 32QFN, 4X4 MM PACKAGE SIZE INFORMATION (IS1871SF)

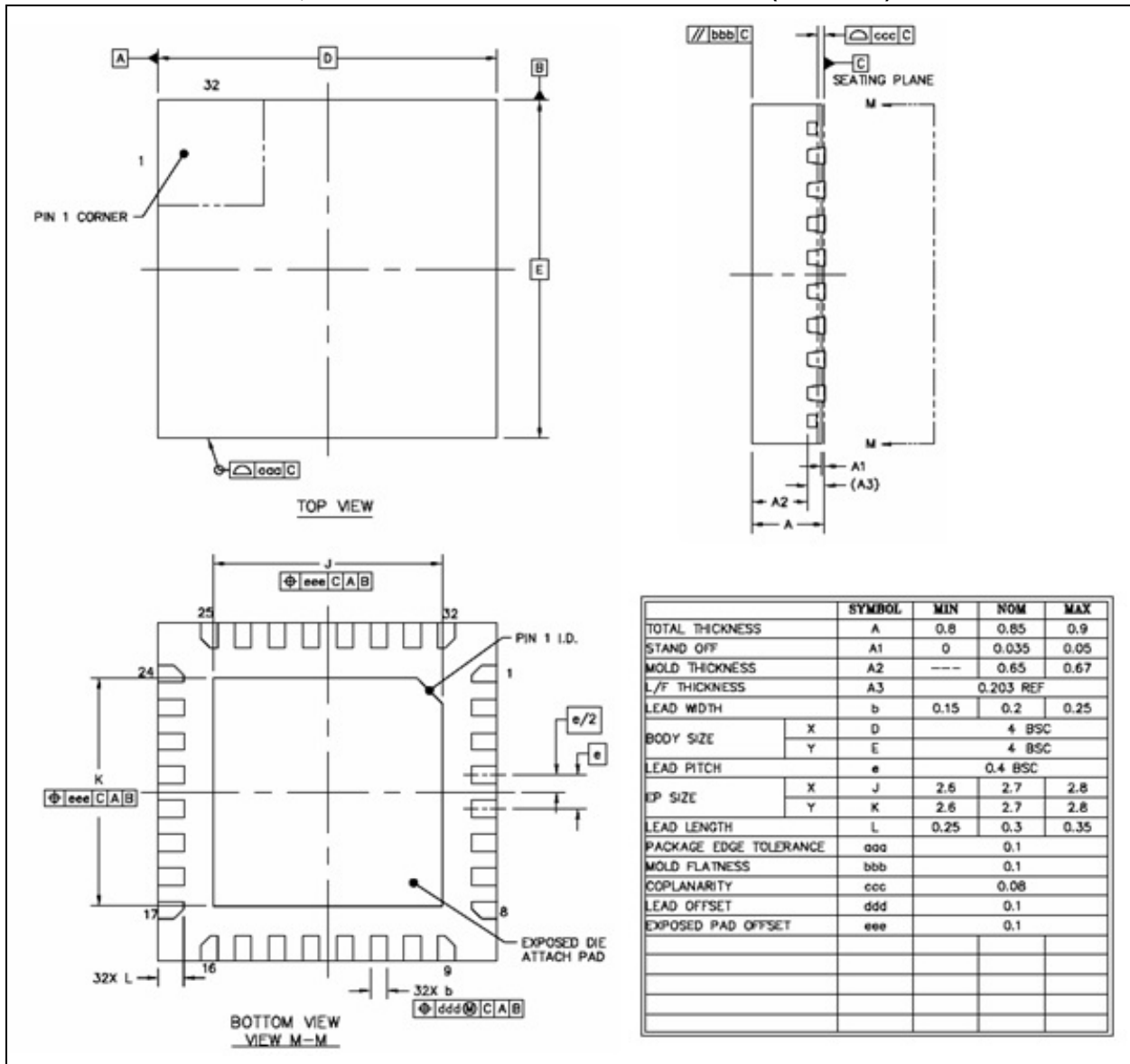
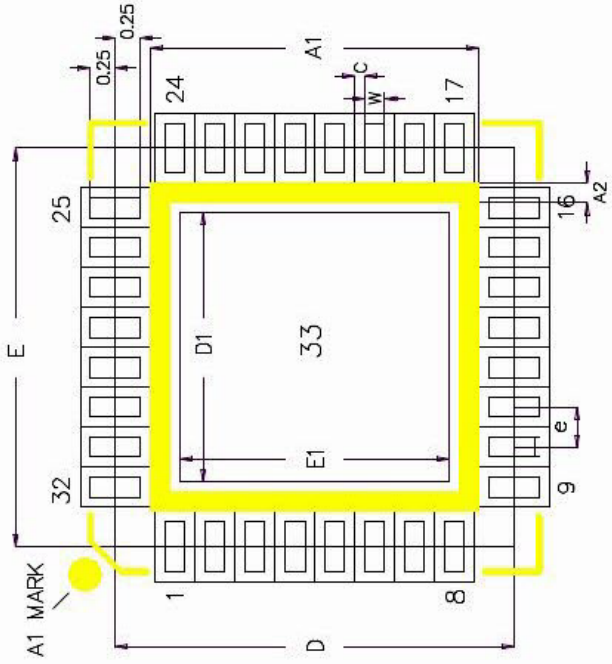

FIGURE 4-4: 32QFN FOOTPRINT INFORMATION (IS1871SF)

### Recommended Board Layout of Solder Pad



TOP VIEW

	SYMBOL	COMMON MIN.
SILKSCREEN TOP L	A1	
SILKSCREEN TOP W	A2	
BODY SIZE	D	
	E	
	D1	
EXPOSED PAD SIZE	E1	
LEAD LENGTH	L	
LEAD WIDTH	W	
SOLDER MASKER OPEN	c	
LEAD PITCH	e	
LEAD COUNT	n1	

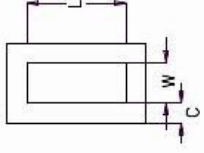

SOLDERMASK OPENING OUTSIDE OF  
SCALE 2:1

**FIGURE 4-5: PACKAGE MARKING INFORMATION**

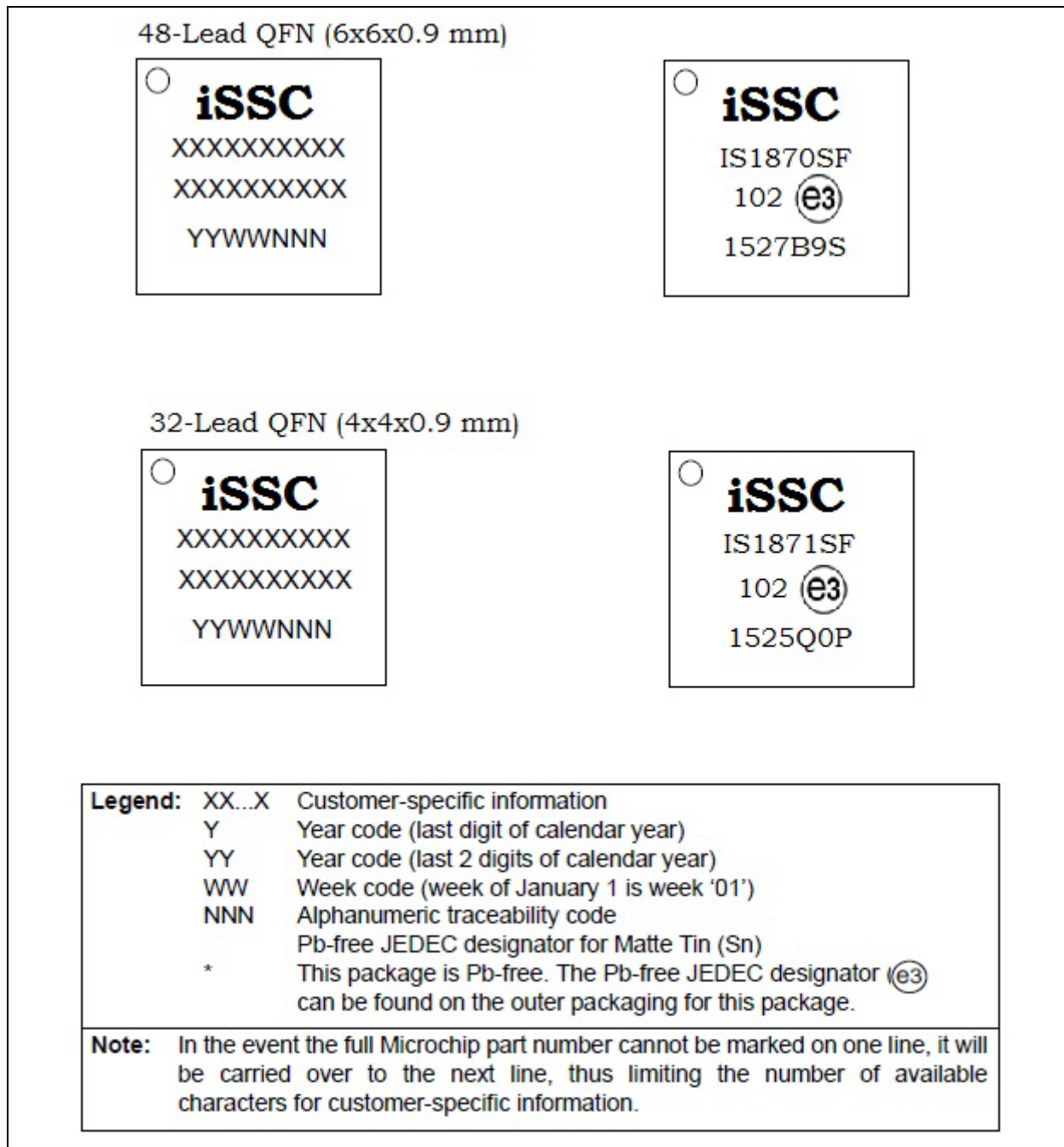

# IS1870/71

---

NOTES:

## 5.0 REFLOW PROFILE AND STORAGE CONDITION

Figure 5-1 and Figure 5-2 illustrate the reflow profiles and stencil information of the IS1870/71 SoC.

### 5.1 Stencil of SMT Assembly Suggestion

#### 5.1.1 STENCIL TYPE AND THICKNESS

- Laser cutting
- Stainless steel
- Thickness: 0.5 mm pitch, thickness more than 0.15 mm

#### 5.1.2 APERTURE SIZE AND SHAPE FOR TERMINAL PAD

- Aspect ratio (width/thickness) more than 1.5
- Aperture shape
  - The stencil aperture is designed to match the

pad size on the PCB

- Oval-shape opening is used to get the optimum paste release
- Rounded corners to minimize the clogging
- Positive taper walls (5° tapering) with the bottom opening larger than the top opening

#### 5.1.3 APERTURE DESIGN FOR THERMAL PAD

- Small multiple openings are used instead of one big opening, see Figure 5-1
- 60 to 80% solder paste coverage
- Rounded corners to minimize clogging
- Positive taper walls (5° tapering) with the bottom opening larger than the top opening, see Figure 5-2

FIGURE 5-1: REFLOW PROFILE

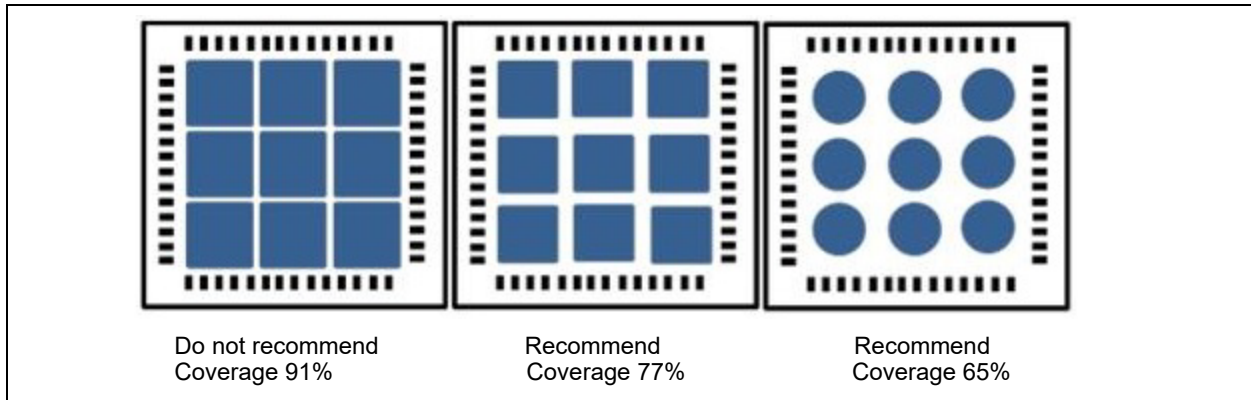
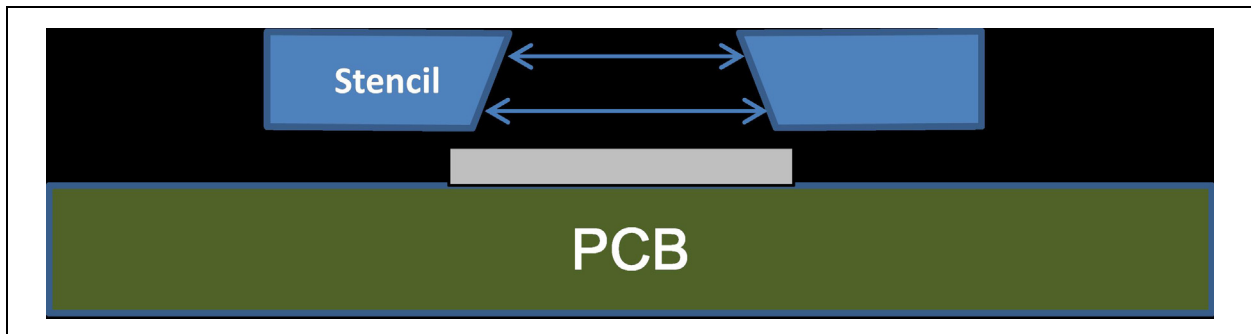

FIGURE 5-2: STENCIL TYPE



# IS1870/71

## 5.2 Reflow Profile

Figure 5-3 illustrates the reflow profile and the following are its specific features:

- Standard Condition: IPC/JEDEC J-STD-020
- Preheat: +150 °C to +200 °C for 60 to 120 seconds
- Average ramp-up rate (+217°C to peak): +3°C/sec max
- Temperature maintained above +217 °C : 60 to 150 seconds
- Time within +5 °C of peak temperature: 30 to 40 seconds
- Peak temperature: +260 °C with 5/-0 °C tolerance
- Ramp-down rate (peak to +217°C): +6°C/sec. max
- Time within +25°C to peak temperature: 8 minutes max
- Cycle interval: 5 minutes

FIGURE 5-3: REFLOW PROFILE

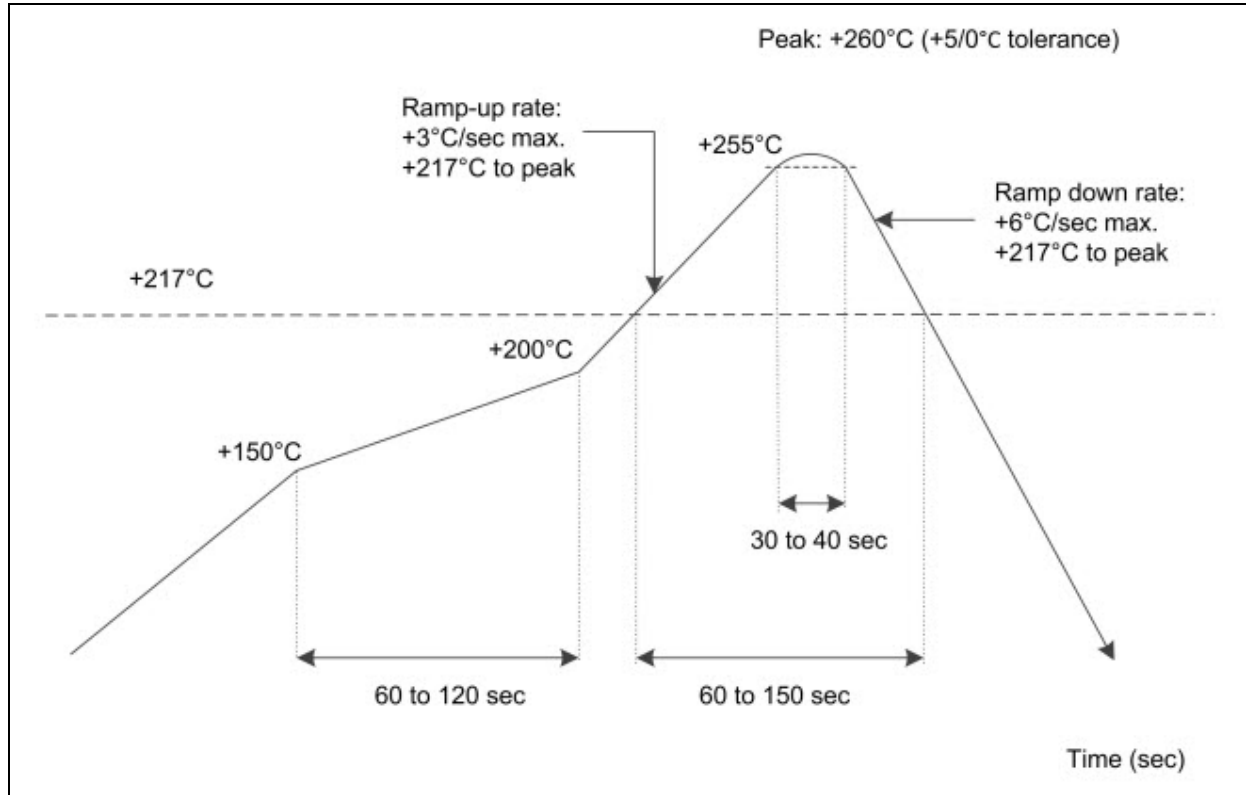

## 5.3 Storage Condition

Users are required to follow these specific storage conditions for the IS1870/71 SoC.

- The calculated shelf life in the sealed bag is 24 months at  $<+40\text{ }^{\circ}\text{C}$  and  $<90\%$  Relative Humidity (RH)
- After the bag is opened, devices that are subjected to reflow solder or other high temperature process must be mounted within 168 hours of factory conditions, i.e  $<+30\text{ }^{\circ}\text{C}$  /60% RH

# IS1870/71

---

NOTES:

## 6.0 ORDERING GUIDE

Table 6-1 provides the ordering information for the IS1870/71 SoC.

**TABLE 6-1: ORDERING GUIDE**

Device	Bluetooth Version	Operating Temperature Range	Package	Part No.
IS1870SF-102	Bluetooth Low Energy SoC, Bluetooth Low Energy 5.0 compliant	-20°C to +70°C	48-Lead QFN, 6x6x0.9 mm <sup>3</sup> , 0.4 mm pitch	IS1870SF-102
IS1871SF-102	Bluetooth Low Energy SoC, Bluetooth Low Energy 5.0 compliant	-20°C to +70°C	32-Lead QFN, 4x4x0.9 mm <sup>3</sup> , 0.4 mm pitch	IS1871SF-102
IS1870SF-202	Bluetooth Low Energy SoC, Bluetooth Low Energy 5.0 compliant	-40°C to +85°C	48-Lead QFN, 6x6x0.9 mm <sup>3</sup> , 0.4 mm pitch	IS1870SF-202
IS1871SF-202	Bluetooth Low Energy SoC, Bluetooth Low Energy 5.0 compliant	-40°C to +85°C	32-Lead QFN, 4x4x0.9 mm <sup>3</sup> , 0.4 mm pitch	IS1871SF-202

**Note:** The IS1870/71 SoC can be purchased through a Microchip representative. Visit <http://www.microchip.com/> for ordering information.

# IS1870/71

---

---

NOTES:

## APPENDIX A: REFERENCE CIRCUIT

The application circuit lists the RF matching circuit option, test points and configuration table. The GPIOs are used for general I/O functions or the function of ADC, PTS, PWT, and 100 kHz crystal.

Figure A-1 through Figure A-4 illustrate a typical application circuit of the IS1870 and IS1871 SoC.

FIGURE A-1: IS1870 SOC APPLICATION CIRCUIT

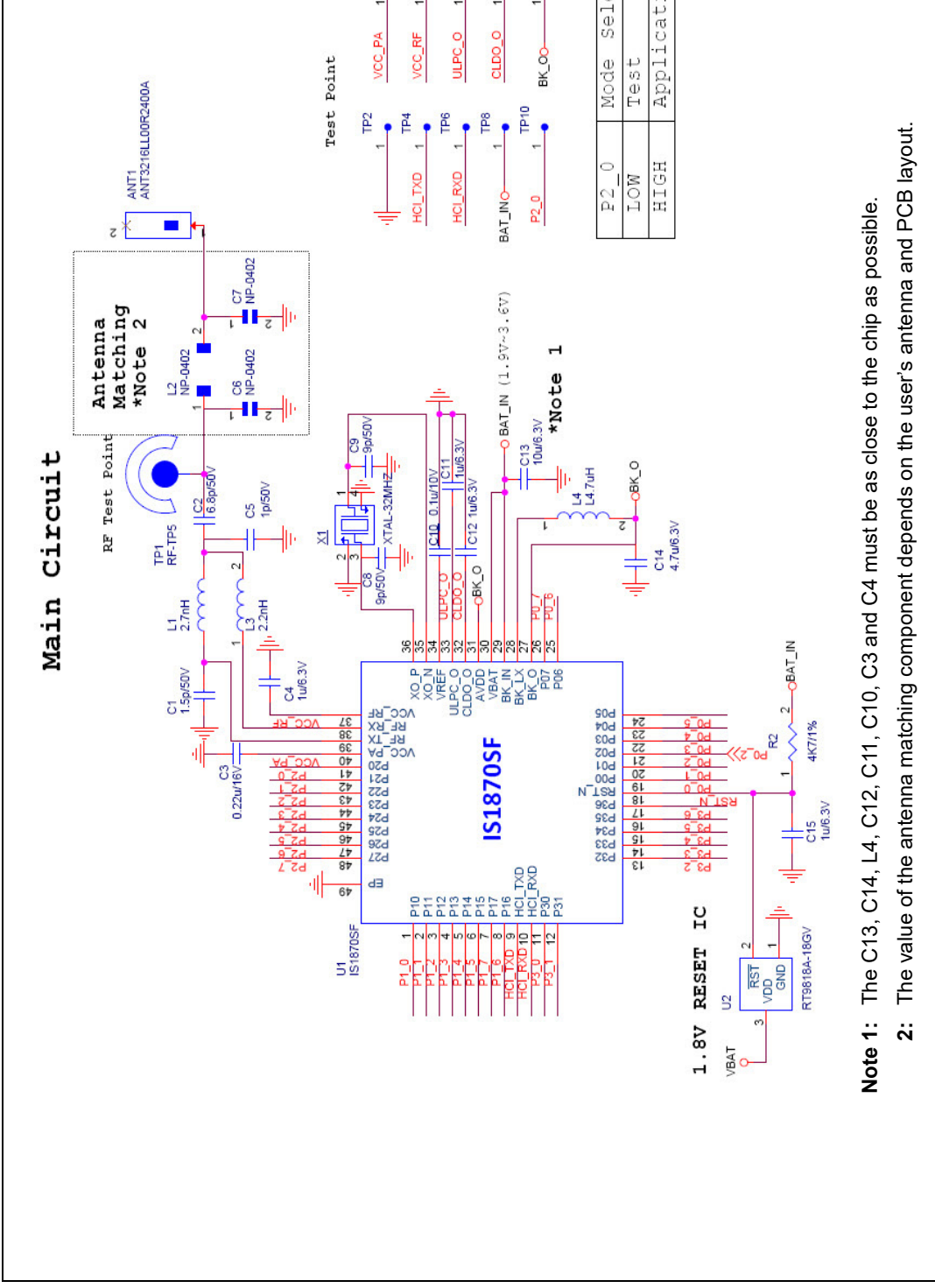

**Note 1:** The C13, C14, L4, C12, C11, C10, C3 and C4 must be as close to the chip as possible.

**2:** The value of the antenna matching component depends on the user's antenna and PCB layout.

**FIGURE A-2: IS1870 SOC APPLICATION CIRCUIT (OPTIONAL)**

**Optional Circuit**

**LED Option**

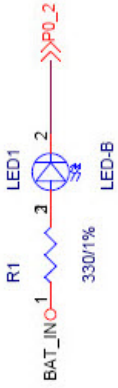

\*Used in BAT\_IN > 3.0V condition to ensure LED is bright enough

**Battery Reverse Protection**

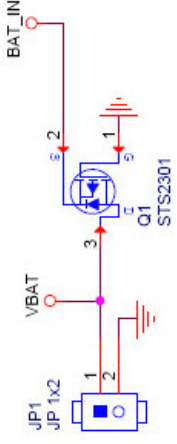

\*Voltage reverse protection reverse battery input

**External 32KHz Crystal Option**

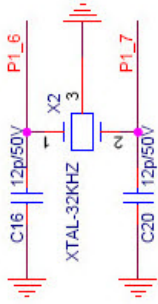
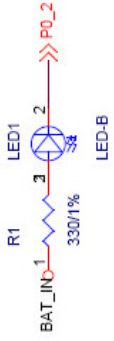



FIGURE A-4: IS1871 SOC APPLICATION CIRCUIT (OPTIONAL)

## Optional Circuit

### LED Option



\*Used in BAT\_IN > 3.0V condition to ensure LED is bright enough

### Battery Reverse Protection

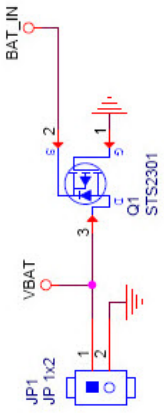

\*Voltage reverse protection in reverse battery input condition

### External 32KHz Crystal Option

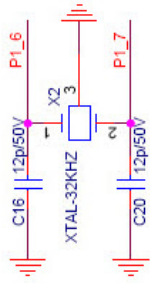

## APPENDIX B: LAYOUT GUIDELINES

### B.1 RF Matching

The RF traces (Tx, Rx and antenna path) on the PCB antenna must match the 50 Ohm impedance. In [Figure A-1](#), value of L1, L3, C1, C2 and C5 are fixed. The antenna matching components, C6, C7 and L2, must be adjusted to match with the 50 Ohm 2.4 GHz antenna.

### B.2 PMU

The PMU section components, such as VBAT, BK\_IN, BK\_O, BK\_LX, AVDD, ULPC\_O, CLDO\_O, VREF must be kept close to the IS1870/71 SoC. The L4 and C14 of Buck section, illustrated in [Figure A-1](#), must be selected carefully. The capacitor C14 is either 4.7  $\mu$ F/6.3V, X5R or X7R type. The inductor L4 must be a high current ( $I_{bc}>300$  mA) and low DCR ( $<1$  Ohm) type.

For additional information on the PCB antenna design guidelines, contact your local Microchip sales office. A list of Microchip sales offices is given on the back page of this document.

### B.3 Crystal

The XI 32 MHz crystal specification must be within the  $\pm 10$  ppm range, see [Figure A-1](#).

NOTES:

## APPENDIX C: REVISION HISTORY

### Revision A (October 2015)

This is the initial released version of this document.

### Revision B (October 2015)

This revision includes the following changes as well as minor updates to text and formatting, which were incorporated throughout the document.

Status	Description
<b>“Features”</b>	The section has been updated with new information.
<b>“Packages”</b>	The section is updated with the package information.
<b>1.0 “Device Overview”</b>	Updated <a href="#">Figure 1-1</a> and <a href="#">Figure 1-2</a> . Added <a href="#">Table 1-1</a>

### Revision C (March 2016)

This revision includes the following changes and minor updates to text and formatting, which were incorporated throughout the document.

Status	Description
<b>“Features”</b>	The section is updated with new information.
<b>1.0 “Device Overview”</b>	Updated <a href="#">Figure 1-1</a> and <a href="#">Figure 1-2</a> . Updated <a href="#">Table 1-1</a> and <a href="#">Table 1-2</a> .
<b>2.0 “System Block Details”</b>	Updated <b>2.2 “System Block Specification”</b> and <b>2.3 “Host MCU Interface Over UART”</b> with new information.
<b>3.0 “Electrical Characteristics”</b>	Updated <b>3.1.1 “Tx/Rx Current Consumption Details”</b> . Updated <a href="#">Figure 3-1</a> and <a href="#">Figure 3-1</a> . Updated <a href="#">Table 3-1</a> and <a href="#">Table 3-2</a> .
<b>5.3 “Storage Condition”</b>	Deleted <a href="#">Figure 5-4</a> .
<b>6.0 “Ordering Guide”</b>	Updated <a href="#">Table 6-1</a>
<b>Appendix A: “Reference Circuit”</b>	Updated <a href="#">Figure A-1</a> and <a href="#">Figure A-3</a> Added <a href="#">Figure A-2</a> and <a href="#">Figure A-4</a>
<b>Appendix C: Bill of Material</b>	Deleted

### Revision D (February 2017)

This revision includes the following changes and minor updates to text and formatting, which were incorporated throughout the document.

Section	Update Description
<b>“Features”</b>	Updated this section.
<b>“Packages”</b>	Updated the I/O pins details.
<b>“Operating Conditions”</b>	Updated the operating temperature details.
<b>1.0 “Device Overview”</b>	Updated <a href="#">Figure 1-1</a> and <a href="#">Figure 1-2</a> .
<b>2.0 “System Block Details”</b>	Updated <a href="#">Figure 2-2</a> .
<b>3.0 “Electrical Characteristics”</b>	Updated ambient temperature, maximum output (human-body model) details and <a href="#">Table 3-1</a> . Added <a href="#">Table 3-2</a> .
<b>6.0 “Ordering Guide”</b>	Updated <a href="#">Table 6-1</a>

# IS1870/71

## Revision E (February 2018)

This revision includes the following changes and minor updates to text and formatting, which were incorporated throughout the document.

Section	Update Description
1.0 “Device Overview”	Updated <a href="#">Table 1-2</a> .
3.0 “Electrical Characteristics”	Updated <a href="#">Table 3-1</a> .

## Revision F (February 2021)

This revision includes the following changes and minor updates to text and formatting, which were incorporated throughout the document.

Section	Update Description
2.2 “System Block Specification”	Performed following change: <ul style="list-style-type: none"><li>• 4-wire master/slave SPI to 4-wire SPI</li></ul>
3.0 “Electrical Characteristics”	Updated the following values in <a href="#">Table 3-1</a> . <ul style="list-style-type: none"><li>• Digital Output Min value from 1387 to 1160</li><li>• Digital Output Max value from 2448 to 2649</li></ul>

## Revision G (September 2021)

This revision includes the following changes and minor updates to text and formatting, which were incorporated throughout the document.

Section	Update Description
1.0 “Device Overview”	Performed following change: <ul style="list-style-type: none"><li>• Updated Bluetooth version from 4.2 to 5.0</li><li>• Updated <a href="#">Table 1-2</a> with new terminology, see the following note</li></ul>
2.2 “System Block Specification”	Performed the following change: <ul style="list-style-type: none"><li>• Updated Bluetooth version from 4.2 to 5.0</li></ul>
6.0 “Ordering Guide”	Performed the following change: <ul style="list-style-type: none"><li>• Updated Bluetooth version from 4.2 to 5.0</li></ul>

**Note:** Microchip is aware that some terminologies used in the technical documents and existing software codes of this product are outdated and unsuitable. This document may use these new terminologies, which may or may not reflect on the source codes, software GUIs, and the documents referenced within this document. The following table shows the relevant terminology changes made in this document.

**TABLE G-1: TERMINOLOGY RELATED CHANGES**

Old Terminology	New Terminology	Description
Master mode	Central mode	<a href="#">Table 1-2</a> is updated with new terminology.

---

---

**Note the following details of the code protection feature on Microchip products:**

- Microchip products meet the specifications contained in their particular Microchip Data Sheet.
- Microchip believes that its family of products is secure when used in the intended manner, within operating specifications, and under normal conditions.
- Microchip values and aggressively protects its intellectual property rights. Attempts to breach the code protection features of Microchip product is strictly prohibited and may violate the Digital Millennium Copyright Act.
- Neither Microchip nor any other semiconductor manufacturer can guarantee the security of its code. Code protection does not mean that we are guaranteeing the product is “unbreakable”. Code protection is constantly evolving. Microchip is committed to continuously improving the code protection features of our products.

---

This publication and the information herein may be used only with Microchip products, including to design, test, and integrate Microchip products with your application. Use of this information in any other manner violates these terms. Information regarding device applications is provided only for your convenience and may be superseded by updates. It is your responsibility to ensure that your application meets with your specifications. Contact your local Microchip sales office for additional support or, obtain additional support at <https://www.microchip.com/en-us/support/design-help/client-support-services>.

THIS INFORMATION IS PROVIDED BY MICROCHIP "AS IS". MICROCHIP MAKES NO REPRESENTATIONS OR WARRANTIES OF ANY KIND WHETHER EXPRESS OR IMPLIED, WRITTEN OR ORAL, STATUTORY OR OTHERWISE, RELATED TO THE INFORMATION INCLUDING BUT NOT LIMITED TO ANY IMPLIED WARRANTIES OF NON-INFRINGEMENT, MERCHANTABILITY, AND FITNESS FOR A PARTICULAR PURPOSE, OR WARRANTIES RELATED TO ITS CONDITION, QUALITY, OR PERFORMANCE.

IN NO EVENT WILL MICROCHIP BE LIABLE FOR ANY INDIRECT, SPECIAL, PUNITIVE, INCIDENTAL, OR CONSEQUENTIAL LOSS, DAMAGE, COST, OR EXPENSE OF ANY KIND WHATSOEVER RELATED TO THE INFORMATION OR ITS USE, HOWEVER CAUSED, EVEN IF MICROCHIP HAS BEEN ADVISED OF THE POSSIBILITY OR THE DAMAGES ARE FORESEEABLE. TO THE FULLEST EXTENT ALLOWED BY LAW, MICROCHIP'S TOTAL LIABILITY ON ALL CLAIMS IN ANY WAY RELATED TO THE INFORMATION OR ITS USE WILL NOT EXCEED THE AMOUNT OF FEES, IF ANY, THAT YOU HAVE PAID DIRECTLY TO MICROCHIP FOR THE INFORMATION.

Use of Microchip devices in life support and/or safety applications is entirely at the buyer's risk, and the buyer agrees to defend, indemnify and hold harmless Microchip from any and all damages, claims, suits, or expenses resulting from such use. No licenses are conveyed, implicitly or otherwise, under any Microchip intellectual property rights unless otherwise stated.

For information regarding Microchip's Quality Management Systems, please visit [www.microchip.com/quality](http://www.microchip.com/quality).

**Trademarks**

The Microchip name and logo, the Microchip logo, Adaptec, AnyRate, AVR, AVR logo, AVR Freaks, BesTime, BitCloud, CryptoMemory, CryptoRF, dsPIC, flexPWR, HELDO, IGLOO, JukeBlox, KeeLoq, Kleer, LANCheck, LinkMD, maXStylus, maXTouch, MediaLB, megaAVR, Microsemi, Microsemi logo, MOST, MOST logo, MPLAB, OptoLyzer, PIC, picoPower, PICSTART, PIC32 logo, PolarFire, Prochip Designer, QTouch, SAM-BA, SenGenuity, SpyNIC, SST, SST Logo, SuperFlash, Symmetricom, SyncServer, Tachyon, TimeSource, tinyAVR, UNI/O, Vectron, and XMEGA are registered trademarks of Microchip Technology Incorporated in the U.S.A. and other countries.

AgileSwitch, APT, ClockWorks, The Embedded Control Solutions Company, EtherSynch, Flashtec, Hyper Speed Control, HyperLight Load, IntelliMOS, Libero, motorBench, mTouch, Powermite 3, Precision Edge, ProASIC, ProASIC Plus, ProASIC Plus logo, QuietWire, SmartFusion, SyncWorld, Temux, TimeCesium, TimeHub, TimePictra, TimeProvider, TrueTime, WinPath, and ZL are registered trademarks of Microchip Technology Incorporated in the U.S.A.

Adjacent Key Suppression, AKS, Analog-for-the-Digital Age, Any Capacitor, AnyIn, AnyOut, Augmented Switching, BlueSky, BodyCom, CodeGuard, CryptoAuthentication, CryptoAutomotive, CryptoCompanion, CryptoController, dsPICDEM, dsPICDEM.net, Dynamic Average Matching, DAM, ECAN, Espresso T1S, EtherGREEN, GridTime, IdealBridge, In-Circuit Serial Programming, ICSP, INICnet, Intelligent Paralleling, Inter-Chip Connectivity, JitterBlocker, Knob-on-Display, maxCrypto, maxView, memBrain, Mindi, MiWi, MPASM, MPF, MPLAB Certified logo, MPLIB, MPLINK, MultiTRAK, NetDetach, NVM Express, NVMe, Omniscient Code Generation, PICDEM, PICDEM.net, PICKit, PICtail, PowerSmart, PureSilicon, QMatrix, REAL ICE, Ripple Blocker, RTAX, RTG4, SAM-ICE, Serial Quad I/O, simpleMAP, SimpliPHY, SmartBuffer, SmartHLS, SMART-I.S., storClad, SQL, SuperSwitcher, SuperSwitcher II, Switchtec, SynchroPHY, Total Endurance, TSHARC, USBCheck, VariSense, VectorBlox, VeriPHY, ViewSpan, WiperLock, XpressConnect, and ZENA are trademarks of Microchip Technology Incorporated in the U.S.A. and other countries.

SQTP is a service mark of Microchip Technology Incorporated in the U.S.A.

The Adaptec logo, Frequency on Demand, Silicon Storage Technology, Symmcom, and Trusted Time are registered trademarks of Microchip Technology Inc. in other countries.

GestIC is a registered trademark of Microchip Technology Germany II GmbH & Co. KG, a subsidiary of Microchip Technology Inc., in other countries.

All other trademarks mentioned herein are property of their respective companies.

© 2015-2021, Microchip Technology Incorporated and its subsidiaries.

All Rights Reserved.

ISBN: 978-1-5224-8899-6



# MICROCHIP

## Worldwide Sales and Service

### AMERICAS

**Corporate Office**  
2355 West Chandler Blvd.  
Chandler, AZ 85224-6199  
Tel: 480-792-7200  
Fax: 480-792-7277  
Technical Support:  
[http://www.microchip.com/  
support](http://www.microchip.com/support)  
Web Address:  
[www.microchip.com](http://www.microchip.com)

#### Atlanta

Duluth, GA  
Tel: 678-957-9614  
Fax: 678-957-1455

#### Austin, TX

Tel: 512-257-3370

#### Boston

Westborough, MA  
Tel: 774-760-0087  
Fax: 774-760-0088

#### Chicago

Itasca, IL  
Tel: 630-285-0071  
Fax: 630-285-0075

#### Dallas

Addison, TX  
Tel: 972-818-7423  
Fax: 972-818-2924

#### Detroit

Novi, MI  
Tel: 248-848-4000

#### Houston, TX

Tel: 281-894-5983

#### Indianapolis

Noblesville, IN  
Tel: 317-773-8323  
Fax: 317-773-5453  
Tel: 317-536-2380

#### Los Angeles

Mission Viejo, CA  
Tel: 949-462-9523  
Fax: 949-462-9608  
Tel: 951-273-7800

#### Raleigh, NC

Tel: 919-844-7510

#### New York, NY

Tel: 631-435-6000

#### San Jose, CA

Tel: 408-735-9110  
Tel: 408-436-4270

#### Canada - Toronto

Tel: 905-695-1980  
Fax: 905-695-2078

### ASIA/PACIFIC

**Australia - Sydney**  
Tel: 61-2-9868-6733

**China - Beijing**  
Tel: 86-10-8569-7000

**China - Chengdu**  
Tel: 86-28-8665-5511

**China - Chongqing**  
Tel: 86-23-8980-9588

**China - Dongguan**  
Tel: 86-769-8702-9880

**China - Guangzhou**  
Tel: 86-20-8755-8029

**China - Hangzhou**  
Tel: 86-571-8792-8115

**China - Hong Kong SAR**  
Tel: 852-2943-5100

**China - Nanjing**  
Tel: 86-25-8473-2460

**China - Qingdao**  
Tel: 86-532-8502-7355

**China - Shanghai**  
Tel: 86-21-3326-8000

**China - Shenyang**  
Tel: 86-24-2334-2829

**China - Shenzhen**  
Tel: 86-755-8864-2200

**China - Suzhou**  
Tel: 86-186-6233-1526

**China - Wuhan**  
Tel: 86-27-5980-5300

**China - Xian**  
Tel: 86-29-8833-7252

**China - Xiamen**  
Tel: 86-592-2388138

**China - Zhuhai**  
Tel: 86-756-3210040

### ASIA/PACIFIC

**India - Bangalore**  
Tel: 91-80-3090-4444

**India - New Delhi**  
Tel: 91-11-4160-8631

**India - Pune**  
Tel: 91-20-4121-0141

**Japan - Osaka**  
Tel: 81-6-6152-7160

**Japan - Tokyo**  
Tel: 81-3-6880-3770

**Korea - Daegu**  
Tel: 82-53-744-4301

**Korea - Seoul**  
Tel: 82-2-554-7200

**Malaysia - Kuala Lumpur**  
Tel: 60-3-7651-7906

**Malaysia - Penang**  
Tel: 60-4-227-8870

**Philippines - Manila**  
Tel: 63-2-634-9065

**Singapore**  
Tel: 65-6334-8870

**Taiwan - Hsin Chu**  
Tel: 886-3-577-8366

**Taiwan - Kaohsiung**  
Tel: 886-7-213-7830

**Taiwan - Taipei**  
Tel: 886-2-2508-8600

**Thailand - Bangkok**  
Tel: 66-2-694-1351

**Vietnam - Ho Chi Minh**  
Tel: 84-28-5448-2100

### EUROPE

**Austria - Wels**  
Tel: 43-7242-2244-39  
Fax: 43-7242-2244-393

**Denmark - Copenhagen**  
Tel: 45-4485-5910  
Fax: 45-4485-2829

**Finland - Espoo**  
Tel: 358-9-4520-820

**France - Paris**  
Tel: 33-1-69-53-63-20  
Fax: 33-1-69-30-90-79

**Germany - Garching**  
Tel: 49-8931-9700

**Germany - Haan**  
Tel: 49-2129-3766400

**Germany - Heilbronn**  
Tel: 49-7131-72400

**Germany - Karlsruhe**  
Tel: 49-721-625370

**Germany - Munich**  
Tel: 49-89-627-144-0  
Fax: 49-89-627-144-44

**Germany - Rosenheim**  
Tel: 49-8031-354-560

**Israel - Ra'anana**  
Tel: 972-9-744-7705

**Italy - Milan**  
Tel: 39-0331-742611  
Fax: 39-0331-466781

**Italy - Padova**  
Tel: 39-049-7625286

**Netherlands - Drunen**  
Tel: 31-416-690399  
Fax: 31-416-690340

**Norway - Trondheim**  
Tel: 47-7288-4388

**Poland - Warsaw**  
Tel: 48-22-3325737

**Romania - Bucharest**  
Tel: 40-21-407-87-50

**Spain - Madrid**  
Tel: 34-91-708-08-90  
Fax: 34-91-708-08-91

**Sweden - Gothenberg**  
Tel: 46-31-704-60-40

**Sweden - Stockholm**  
Tel: 46-8-5090-4654

**UK - Wokingham**  
Tel: 44-118-921-5800  
Fax: 44-118-921-5820

## Looking for pricing, stock, or lifecycle information?

Click below to explore more details on WIN SOURCE:

-  [View IS1871SF-102 on WIN SOURCE](#)
-  [Microchip Technology](#) Information

## Optimize Your Supply Chain with WIN SOURCE Solutions

-  Global Sourcing Solution
-  Obsolete Management
-  Cost Control Management
-  Shortage Management
-  Alternative Solution
-  Excess Inventory Management