

1cell Li-ion/Li-polymer battery protection IC

MM3860 Series

Description

MM3860 series are Li-ion battery protection IC and detect charge current / discharge current with high precision by current sensing resistor (Rsns). MM3860 have two step discharge overcurrent detection. And system is protected appropriately in the next 2 state, Normal discharge mode and large current discharge mode.

Features

(Unless otherwise specified, Ta=25 degC)

•Detection voltage	Range	Accuracy
Overcharge detection voltage	4.1V to 5.0V, 5mV steps	+/-20mV(Ta=-20 to +60 degC)
Overdischarge detection voltage	2.1V to 3.0V, 50mV steps	+/-35mV
Discharging overcurrent detection voltage 1	6mV to +50mV, 1mV steps	+/-1mV
Discharging overcurrent detection voltage 2	10mV to +100mV, 1mV steps	+/-2mV
Charging overcurrent detection voltage	-6mV to -50mV, 1mV steps	+/-1mV
Short detection voltage1	30mV to 200mV, 10mV steps	+/-5mV
0V battery charge inhibition battery voltage	0.9V fixed	+/-0.3V
•0V battery charge function	Selectable "Permission" or "inhibition"	
•Current consumption at Ta=25 degC		
Normal mode	2.5uA typ. 4.0uA max.	
Standby mode	0.1uA max. (Overdischarge latch function enable.) 0.6uA max. (Overdischarge latch function disable.)	

Applications

- Lithium-ion rechargeable battery pack
- Lithium polymer rechargeable battery pack

Package type

•SON-6F	1.60 × 1.60 × 0.55 [mm]
•SSON-6J/6M	1.40 × 1.40 × 0.55 [mm]
•SSON-6U/6V	1.40 × 1.80 × 0.40 [mm]

Block diagram

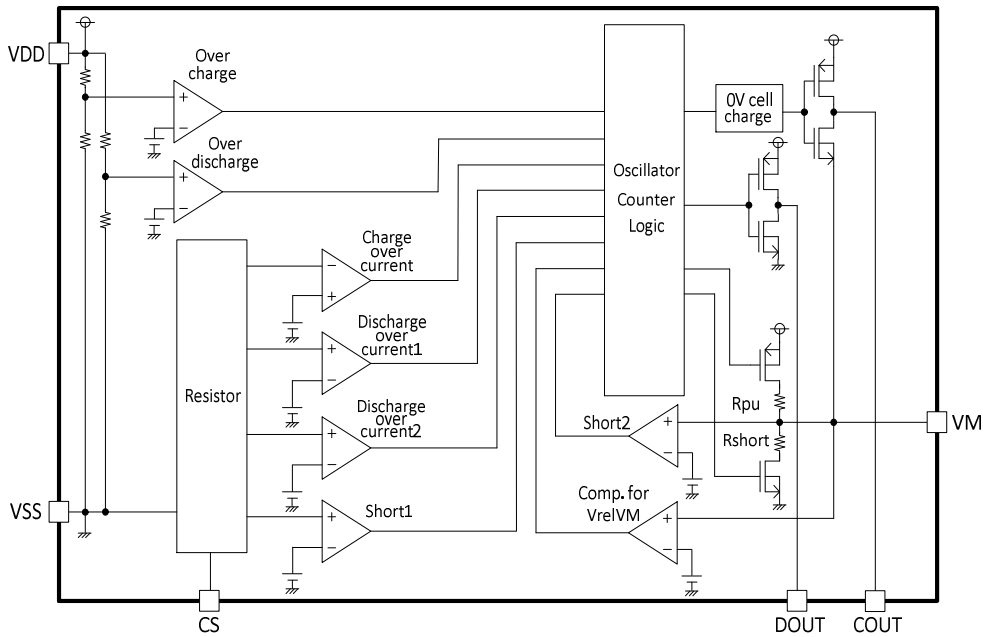

Package and pin configuration

SON-6F		Pin No.	Symbol	Function
	1	VM	Input terminal for charger negative voltage	
	2	COUT	Control terminal for charge FET	
	3	DOUT	Control terminal for discharge FET	
	4	VSS	Input terminal for negative power supply voltage	
	5	VDD	Input terminal for positive power supply voltage	
	6	CS	Input terminal for overcurrent detection	

SSON-6J/6M		Pin No.	Symbol	Function
	1	VSS	Input terminal for negative power supply voltage	
	2	VDD	Input terminal for positive power supply voltage	
	3	CS	Input terminal for overcurrent detection	
	4	VM	Input terminal for charger negative voltage	
	5	COUT	Control terminal for charge FET	
	6	DOUT	Control terminal for discharge FET	

SSON-6U/6V		Pin No.	Symbol	Function
	1	V-	Input terminal for charger negative voltage	
	2	COUT	Control terminal for charge FET	
	3	DOUT	Control terminal for discharge FET	
	4	VSS	Input terminal for negative power supply voltage	
	5	VDD	Input terminal for positive power supply voltage	
	6	CS	Input terminal for overcurrent detection	

Package dimensions

Unit:mm

SON-6F

Top View

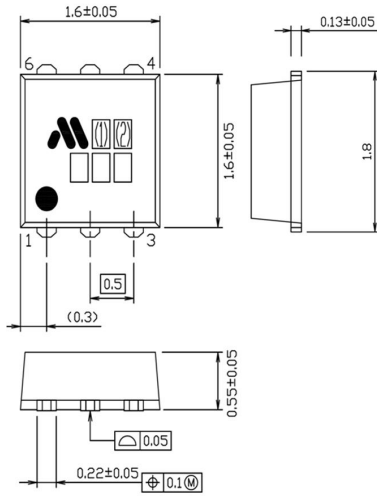

Bottom View

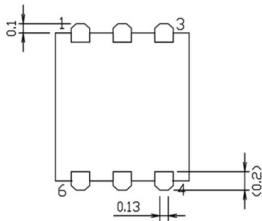

Marking Contents / SON-6F

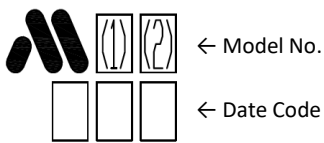

SSON-6J

Top View

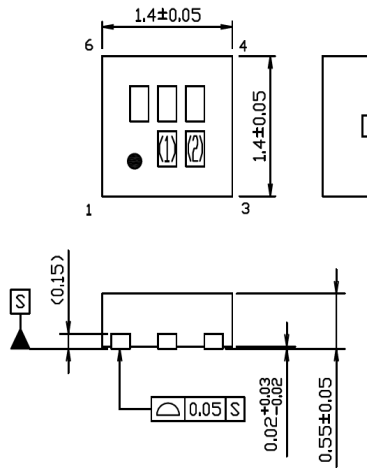

Bottom View

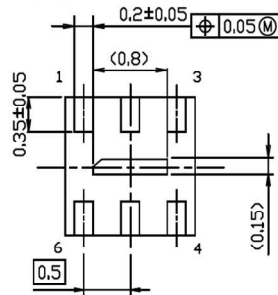

Marking Contents / SSON-6J

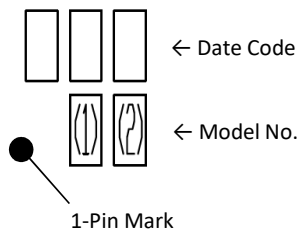

SSON-6M

Top View

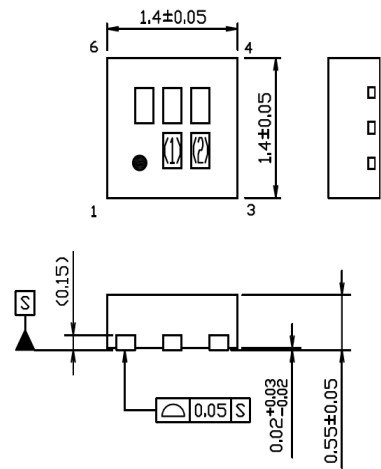

Bottom View

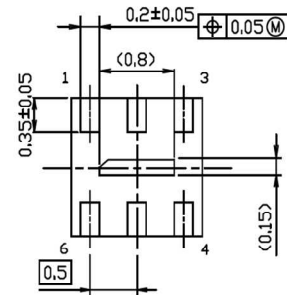

Marking Contents / SSON-6M

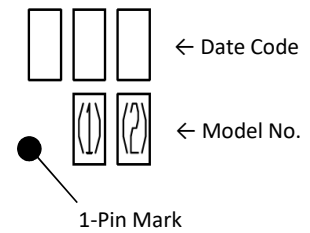

Package dimensions

Unit:mm

SSON-6U

Top View

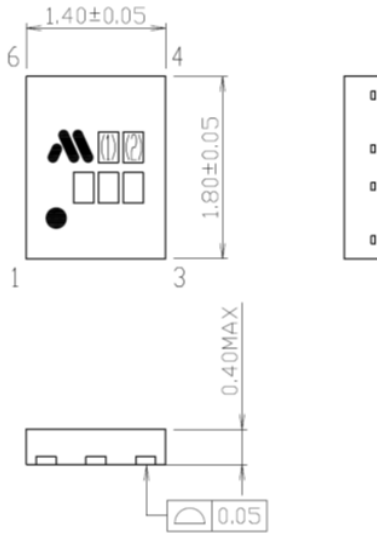

SSON-6V

Top View

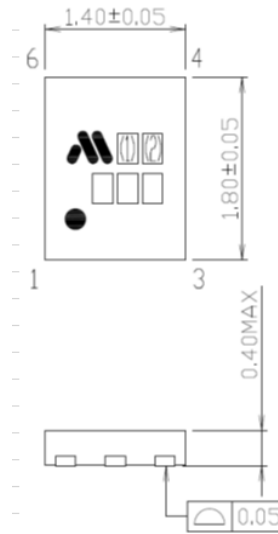

Bottom View

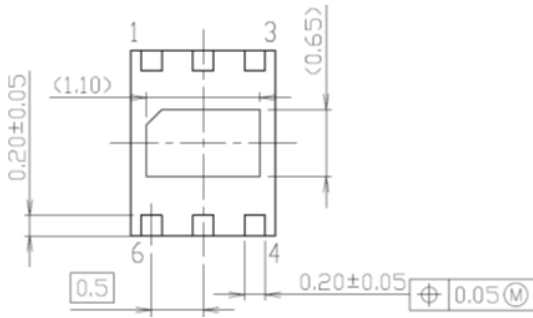

Bottom View

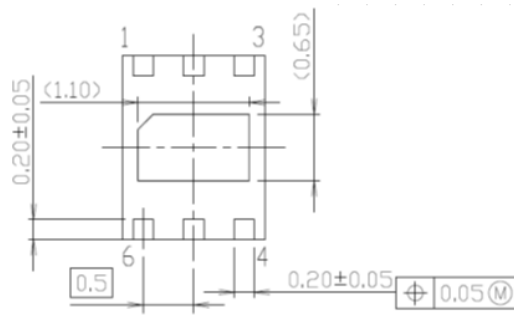

Marking Contents / SSON-6C

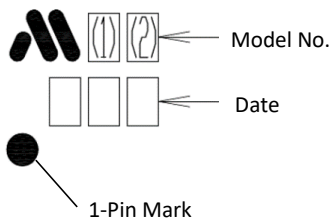

Marking Contents / SSON-6J

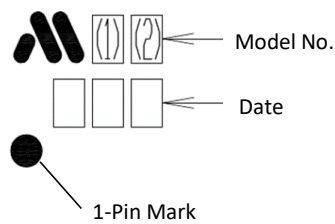

Absolute maximum ratings

Parameter	Symbol	Rating	Unit
Supply voltage	VDD	-0.3 to 12	V
V- terminal	V-	VDD-28 to VDD+0.3	V
COUT terminal	VCO	VDD-28 to VDD+0.3	V
DOUT terminal	VDO	-0.3 to VDD+0.3	V
CS terminal	VCS	-0.3 to VDD+0.3	V
Storage temperature	Tstg	-55 to +125	degC

Recommend operating conditions

Parameter	Symbol	Rating	Unit
Operating ambient temperature	Topr	-40 to +85	degC
Operating voltage	Vop	1.5 to 5.5	V

Electrical characteristics

(Unless otherwise specified, Ta=25 degC)

Parameter	Symbol	Condition	Min.	Typ.	Max.	Unit
Discharge overcurrent release resistance	Rshort	VDD=3.6V, V-=Vcs=1.0V	5.0	10.0	15.0	kohm
V- terminal pull-up resistances	Rpu	VDD=2.0V, V-=Vcs=0V	150	300	600	kohm
COUT L level output voltage	VcoL	VDD=4.5V, Icout=30uA	-	0.1	0.5	V
COUT H level output voltage	VcoH	VDD=4.0V, Icout=-30uA	VDD-0.5	VDD-0.1	-	V
DOUT L level output voltage	VdoL	VDD=2.0V, Idout=30uA	-	0.1	0.5	V
DOUT H level output voltage	VdoH	VDD=4.0V, Idout=-30uA	VDD-0.5	VDD-0.1	-	V
Current consumption	Idd	VDD=4.0V, V-=Vcs=0V	-	2.5	4.0	uA
Standby current	Is	VDD=2.0V, Vcs=0V, V-=VDD※1	-	-	0.1	uA
		VDD=2.0V, Vcs=0V, V-=VDD※2	-	0.3	0.6	

※1 Overdischarge latch function enable.

※2 Overdischarge latch function disable.

Electrical characteristics

(Unless otherwise specified, Ta=25 degC)

Parameter	Symbol	Condition	Min.	Typ.	Max.	Unit
Overcharge detection voltage	Vdet1	Ta=25 degC	-0.020	Vdet1	+0.020	V
		Ta=-20 to +60 degC				
Overcharge release voltage	Vrel1		-0.030	Vrel1	+0.030	V
Overdischarge detection voltage	Vdet2		-0.035	Vdet2	+0.035	V
Overdischarge release voltage	Vrel2		-0.065	Vrel2	+0.090	V
Discharging overcurrent detection voltage 1	Vdet3-1	Ta=25 degC	-1.0	Vdet3-1	+1.0	mV
		Ta=-20 to +60 degC	-1.5		+1.5	
Discharging overcurrent detection voltage 2	Vdet3-2	Ta=25 degC	-2.0	Vdet3-2	+2.0	mV
		Ta=-20 to +60 degC	-2.5		+2.5	
Charging overcurrent detection voltage	Vdet4	Ta=25 degC	-1.0	Vdet4	+1.0	mV
		Ta=-20 to +60 degC	-1.5		+1.5	
Short detection voltage 1	Vshort 1	Ta=25 degC	-5.0	Vshort 1	+5.0	mV
		Ta=-20 to +60 degC	-5.5		+5.5	
Short detection voltage 2	Vshort 2		-0.300	VDD-0.9	+0.300	V
0V battery charge permission charger voltage	Vst		-	-	1.2	V
0V battery charge inhibition battery voltage	Vst		-0.300	0.900	+0.300	V
Monitor voltage for the charger connection	VrelVM		0.150	0.250	0.350	V
Release voltage from discharging overcurrent mode	VrelVM2	VDD=3.7V VCS=0V	-0.300	VDD-1.1	+0.300	V
Overcharge detection delay time	tVdet1		-20%	tVdet1	+20%	s
Overdischarge detection delay time	tVdet2		-20%	tVdet2	+20%	ms
Discharging overcurrent detection1 delay time	tVdet3-1		-20%	tVdet3-1	+20%	ms
Discharging overcurrent detection2 delay time	tVdet3-2		-20%	tVdet3-2	+20%	ms
Charging overcurrent detection delay time	tVdet4		-20%	tVdet4	+20%	ms
Short detection delay time	tshort		-30%	tshort	+40%	us

Typical application circuit

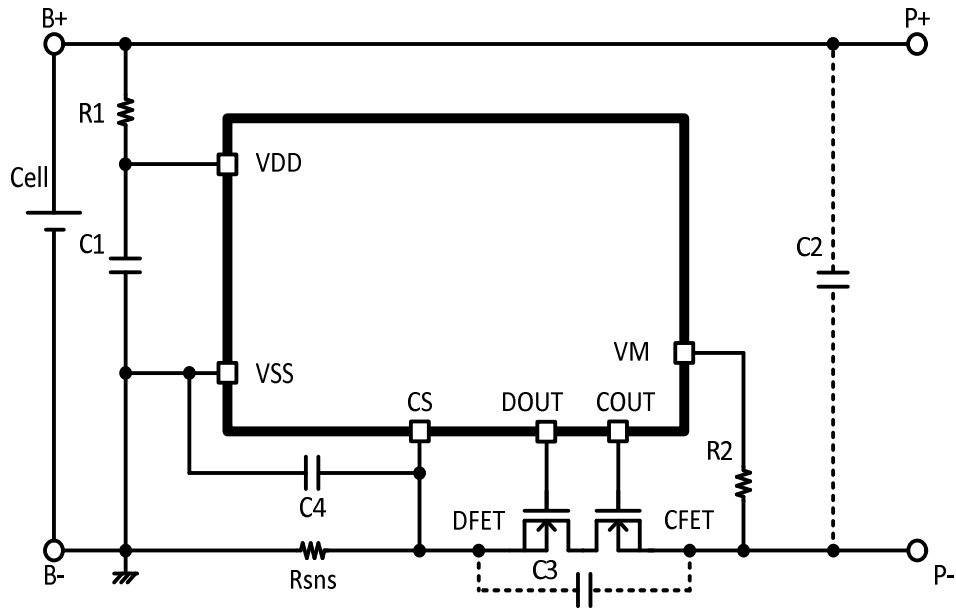

Unit:ohm ,F

Symbol	Part	Min.	Typ.	Max.	Purpose
R1	Resistor	-	100	1k	For voltage fluctuation and ESD
R2	Resistor	-	1k	10k	For current limit of charger reverse connection
Rsns	Resistor	-	-	-	Charge and discharge current sensing
C1	Capacitor	0.01u	0.1u	1.0u	For voltage fluctuation
C2	Capacitor	-	0.1u	-	For exogenous noise
C3	Capacitor	-	0.1u	-	For exogenous noise
C4	Capacitor	-	0.1u	-	For exogenous noise
DFET	Nch MOS FET	-	-	-	Charge and discharge control
CFET					

*The above application circuit and constant value do not guarantee proper operation.

*Please evaluate thoroughly by actual application to set up constants.

Lineup

MODEL	PKG	OV charge	Protection mode latch function			Hys-Cancel		Overcharge detection voltage	Overcharge release voltage	Overdischarge detection voltage	Overdischarge release voltage	Discharging overcurrent detection voltage	Discharging overcurrent detection voltage	Charging overcurrent detection voltage	Short detection voltage	Delay time *1
			Overcharge	Overdischarge	Discharge overcurrent	Overcharge	Overdischarge									
MM3860AC5ZRE	SON-6F	0.9	Disable	Disable	Disable	Enable	Enable	4.475	4.275	2.500	2.900	7.0	-	-11.0	25.0	L
MM3860AC6ZRE	SON-6F	0.9	Disable	Disable	Disable	Enable	Enable	4.520	4.320	2.300	2.500	7.0	-	-11.0	30.0	N
MM3860AC7ZRE	SON-6F	0.9	Disable	Disable	Disable	Enable	Enable	4.540	4.340	2.300	2.500	7.0	-	-11.0	30.0	N
MM3860ACAZRE	SON-6F	0.9	Disable	Disable	Disable	Enable	Enable	4.540	4.340	2.300	2.500	7.0	-	-13.0	30.0	N
MM3860AF4RR4	SSON-6UorV	0.9	Disable	Disable	Disable	Enable	Enable	4.580	4.405	2.300	2.500	15.0	22.0	-20.0	40.0	O
MM3860AF5RR4	SSON-6UorV	0.9	Disable	Disable	Disable	Enable	Enable	4.580	4.405	2.300	2.500	7.0	11.0	-13.0	22.0	O
MM3860AL1ZRE	SON-6F	Permission	Disable	Disable	Disable	Enable	Enable	4.475	4.275	2.500	2.900	7.0	20.0	-7.0	70.0	A
MM3860AL2ZRE	SON-6F	Permission	Disable	Disable	Disable	Enable	Enable	4.530	4.330	2.100	2.300	14.0	20.0	-20.0	55.0	B
MM3860AL3ZRE	SON-6F	Permission	Disable	Disable	Disable	Enable	Enable	4.530	4.330	2.100	2.300	10.5	15.0	-15.0	40.0	B
MM3860AL4ZRE	SON-6F	Permission	Disable	Disable	Disable	Enable	Enable	4.550	4.350	2.100	2.300	7.0	10.0	-10.0	27.0	B
MM3860AL5ZRE	SON-6F	0.9	Disable	Disable	Disable	Enable	Enable	4.475	4.275	2.500	2.900	15.0	-	-15.0	32.0	C
MM3860AL6ZRE	SON-6F	0.9	Disable	Disable	Disable	Enable	Enable	4.520	4.320	2.300	2.500	15.0	-	-15.0	36.0	D
MM3860AL7ZRE	SON-6F	Permission	Disable	Disable	Disable	Enable	Enable	4.500	4.300	2.100	2.300	7.0	10.0	-13.0	27.0	B
MM3860ALDZRE	SON-6F	Permission	Disable	Disable	Disable	Enable	Enable	4.530	4.330	2.350	2.550	21.0	33.0	-24.0	80.0	I
MM3860ALEZRE	SON-6F	Permission	Disable	Disable	Disable	Enable	Enable	4.550	4.350	2.100	2.300	21.0	33.0	-30.0	80.0	I
MM3860ALFZRE	SON-6F	Permission	Disable	Disable	Disable	Enable	Enable	4.530	4.330	2.350	2.550	7.0	12.0	-12.0	28.0	I
MM3860ALGZRE	SON-6F	Permission	Disable	Disable	Disable	Enable	Enable	4.550	4.350	2.100	2.300	7.0	12.0	-14.0	28.0	I
MM3860ALHZRE	SON-6F	Permission	Disable	Disable	Disable	Enable	Enable	4.250	4.150	2.800	3.000	35.0	55.0	-8.0	80.0	M
MM3860ALJRR4	SSON-6UorV	Permission	Disable	Disable	Disable	Enable	Enable	4.555	4.380	2.600	2.800	15.0	22.0	-20.0	40.0	O
MM3860ALKRR4	SSON-6UorV	Permission	Disable	Disable	Disable	Enable	Enable	4.555	4.380	2.600	2.800	7.0	11.0	-13.0	22.0	O
MM3860AN1ZRE	SON-6F	Permission	Disable	Disable	Disable	Enable	Enable	4.445	4.245	2.500	2.900	21.0	-	-16.0	60.0	G
MM3860AN2ZRE	SON-6F	Permission	Disable	Disable	Disable	Enable	Enable	4.480	4.380	2.300	2.700	23.0	-	-18.0	60.0	H
MM3860AN3ZRE	SON-6F	Permission	Disable	Disable	Disable	Enable	Enable	4.445	4.245	2.500	2.900	21.0	-	-22.0	60.0	G
MM3860AN4ZRE	SON-6F	Permission	Disable	Disable	Disable	Enable	Enable	4.480	4.380	2.300	2.700	23.0	-	-24.0	60.0	H
MM3860AN5ZRE	SON-6F	Permission	Disable	Disable	Disable	Enable	Enable	4.445	4.245	2.500	2.900	11.0	-	-12.5	30.0	G
MM3860AN6ZRE	SON-6F	Permission	Disable	Disable	Disable	Enable	Enable	4.480	4.380	2.300	2.700	13.0	-	-14.0	30.0	H
MM3860AN7ZRE	SON-6F	Permission	Disable	Disable	Disable	Enable	Enable	4.480	4.380	2.300	2.700	7.0	-	-7.5	18.0	H
MM3860AN8ZRE	SON-6F	Permission	Disable	Disable	Disable	Enable	Enable	4.450	4.250	2.500	2.900	14.5	22.0	-16.0	60.0	J
MM3860AN9ZRE	SON-6F	Permission	Disable	Disable	Disable	Enable	Enable	4.485	4.385	2.300	2.700	14.5	24.0	-18.0	60.0	K
MM3860ANAZRE	SON-6F	Permission	Disable	Disable	Disable	Enable	Enable	4.450	4.250	2.500	2.900	7.5	12.0	-12.5	30.0	J
MM3860ANBZRE	SON-6F	Permission	Disable	Disable	Disable	Enable	Enable	4.485	4.385	2.300	2.700	7.5	14.0	-14.0	30.0	K
MM3860ANCZRE	SON-6F	Permission	Disable	Disable	Disable	Enable	Enable	4.490	4.290	2.500	2.900	11.0	-	-8.5	30.0	G
MM3860ANDZRE	SON-6F	Permission	Disable	Disable	Disable	Enable	Enable	4.525	4.425	2.300	2.700	13.0	-	-10.0	30.0	H
MM3860ANEZRE	SON-6F	Permission	Disable	Disable	Disable	Enable	Enable	4.490	4.290	2.500	2.900	11.0	-	-12.5	30.0	G
MM3860ANFZRE	SON-6F	Permission	Disable	Disable	Disable	Enable	Enable	4.525	4.425	2.300	2.700	13.0	-	-14.0	30.0	H
MM3860ANGZRE	SON-6F	Permission	Disable	Disable	Disable	Enable	Enable	4.490	4.290	2.500	2.900	7.5	12.0	-8.5	30.0	P
MM3860ANHZRE	SON-6F	Permission	Disable	Disable	Disable	Enable	Enable	4.525	4.425	2.300	2.700	7.5	14.0	-10.0	30.0	K
MM3860ANJZRE	SON-6F	Permission	Disable	Disable	Disable	Enable	Enable	4.490	4.290	2.500	2.900	7.5	12.0	-12.5	30.0	P
MM3860ANKZRE	SON-6F	Permission	Disable	Disable	Disable	Enable	Enable	4.525	4.425	2.300	2.700	7.5	14.0	-14.0	30.0	K
MM3860BC3ZRE	SON-6F	0.9	Disable	Disable	Disable	Enable	Enable	4.495	4.295	2.500	2.900	7.0	-	-11.0	25.0	L

Lineup

*1 Delay time

	tVdet1 [s]	tVrel1 [ms]	tVdet2 [ms]	tVrel2 [ms]	tVdet3-1 [ms]	tVdet3-2 [ms]	tVrel3 [ms]	tVdet4 [ms]	tVrel4 [ms]	tshort [us]
A	1.024	1.00	64.00	1.00	4096.00	16.00	8.00	16.00	4.00	280
B	1.024	1.00	64.00	1.00	3584.00	16.00	8.00	16.00	1.00	280
C	1.024	1.00	32.00	1.00	64.00	-	8.00	16.00	4.00	250
D	1.024	1.00	64.00	1.00	128.00	-	8.00	64.00	4.00	250
E	1.024	16.00	20.00	1.00	12.00	-	2.00	16.00	1.00	250
F	1.024	16.00	32.00	1.00	3584.00	32.00	8.00	32.00	1.00	250
G	1.024	16.00	128.00	4.00	16.00	-	4.00	8.00	4.00	280
H	1.024	16.00	128.00	1.00	32.00	-	4.00	32.00	4.00	530
I	1.024	1.00	64.00	1.00	3584.00	16.00	8.00	16.00	4.00	280
J	1.024	16.00	128.00	4.00	3584.00	16.00	4.00	8.00	4.00	280
K	1.024	16.00	128.00	1.00	3584.00	32.00	4.00	32.00	4.00	530
L	0.512	1.00	64.00	1.00	128.00	-	8.00	32.00	1.00	280
N	1.024	1.00	64.00	1.00	256.00	-	8.00	64.00	1.00	280
M	1.024	16.00	128.00	1.00	2048.00	4.00	2.00	16.00	1.00	280
O	1.024	1.00	64.00	1.00	3072.00	256.00	8.00	16.00	4.00	280
P	1.024	16.00	128.00	4.00	2048.00	16.00	4.00	8.00	4.00	280
Q	1.024	1.00	32.00	1.00	16.00	-	1.00	16.00	1.00	250
R	1.024	16.00	20.00	1.00	12.00	-	1.00	16.00	1.00	250
S	1.024	16.00	32.00	1.00	20.00	-	1.00	32.00	1.00	500
T	1.024	16.00	96.00	4.00	12.00	-	2.00	8.00	4.00	250
U	2.048	16.00	128.00	4.00	512.00	-	8.00	32.00	8.00	400

NOTES

【Safety Precautions】

- Though Mitsumi Electric Co., Ltd. (hereinafter referred to as "Mitsumi") works continually to improve our product's quality and reliability, semiconductor products may generally malfunction or fail. Customers are responsible for complying with safety standards and for providing adequate designs and safeguards for their hardware, software and systems which minimize risk and avoid situations in which a malfunction or failure of this product could cause loss of human life, bodily injury, or damage to property, including data loss or corruption. Before customers use this product, create designs including this product, or incorporate this product into their own applications, customers must also refer to and comply with (a) the latest versions or all of our relevant information, including without limitation, product specifications, data sheets and application notes for this product and (b) the user's manual, handling instructions or all relevant information for any products which is to be used, or combined with this products. Customers are solely responsible for all aspects of their own product design or applications, including but not limited to (a) determining the appropriateness of the use of this product in such design or applications; (b) evaluating and determining the applicability of any information contained in this document, or in charts, diagrams, programs, algorithms, sample application circuits, or any other referenced documents; and (c) validating all operating parameters for such designs and applications. Mitsumi assumes no liability for customers' product design or applications.
- This product is intended for applying to computers, OA units, communication units, instrumentation units, machine tools, industrial robots, AV units, household electrical appliances, and other general electronic units.

【Precautions for Product Liability Act】

- No responsibility is assumed by us for any consequence resulting from any wrong or improper use or operation, etc. of this product.

【ATTENTION】

- This product is designed and manufactured with the intention of normal use in general electronics. No special circumstance as described below is considered for the use of it when it is designed. With this reason, any use and storage under the circumstances below may affect the performance of this product. Prior confirmation of performance and reliability is requested to customers.
 - Environment with strong static electricity or electromagnetic wave
 - Environment with high temperature or high humidity where dew condensation may occur
- This product is not designed to withstand radioactivity, and must avoid using in a radioactive environment.
- This specification is written in Japanese and English. The English text is faithfully translated into the Japanese. However, if any question arises, Japanese text shall prevail.

Looking for pricing, stock, or lifecycle information?

Click below to explore more details on WIN SOURCE:

 [View MM3860AL5ZRE on WIN SOURCE](#)

 [Mitsumi Information](#)

Optimize Your Supply Chain with WIN SOURCE Solutions

-  Global Sourcing Solution
-  Obsolete Management
-  Cost Control Management
-  Shortage Management
-  Alternative Solution
-  Excess Inventory Management