

D-SUB bus connector - SUBCON-PLUS-MODBUS/IL/BK - 2310808

Please be informed that the data shown in this PDF Document is generated from our Online Catalog. Please find the complete data in the user's documentation. Our General Terms of Use for Downloads are valid (<http://phoenixcontact.com/download>)



D-SUB connector, 9-pos., male connector, two cables to be fed in at 35°, bus system: for Inline Modbus RTU/ ASCII bus coupler termination resistance can be connected via slide switch, pin assignment: 3, 5, 6, 8; screw connection terminal blocks

SUBCON-PLUS-PROFIB



Key commercial data

Packing unit	1 pc
Weight per Piece (excluding packing)	49.1 GRM
Custom tariff number	85366990
Country of origin	Germany

Technical data

Dimensions

Max. cable diameter	10 mm
Min. cable diameter	7.6 mm
Width	16 mm
Height	49.5 mm
Length	60 mm

Ambient conditions

Ambient temperature (operation)	-20 °C ... 75 °C
Ambient temperature (storage/transport)	-25 °C ... 80 °C
Altitude	5000 m (For restrictions see manufacturer's declaration)

General

Nominal voltage U_N	5 V
Nominal current I_N	100 mA
Signal	Modbus
Insertion/withdrawal cycles	> 200

D-SUB bus connector - SUBCON-PLUS-MODBUS/IL/BK - 2310808

Technical data

General

SUBCON fixing screws	4-40 UNC
Tightening torque	0.4 Nm
Housing material	ABS, metal-plated
Pin assignment	3, 5, 6, 8

Connection data

Connection	D-SUB connection
Number of positions	9
Connection method	D-SUB connector
Termination resistor	150 Ω (Can be connected externally) 470 Ω (Can be connected externally)
Connection	PCB connection
Connection method	Screw connection
Conductor cross section stranded min.	0.14 mm ²
Conductor cross section stranded max.	1 mm ²
Conductor cross section solid min.	0.14 mm ²
Conductor cross section solid max.	1.5 mm ²
Conductor cross section AWG/kcmil min.	26
Conductor cross section AWG/kcmil max	16
Stripping length	5 mm
Tightening torque	0.4 Nm

Classifications

eCl@ss

eCl@ss 4.0	27140816
eCl@ss 4.1	27140816
eCl@ss 5.0	27143424
eCl@ss 5.1	27143424
eCl@ss 6.0	27143424
eCl@ss 7.0	27440209
eCl@ss 8.0	27440302

ETIM

ETIM 2.0	EC001132
ETIM 3.0	EC001132
ETIM 4.0	EC001132
ETIM 5.0	EC001132

D-SUB bus connector - SUBCON-PLUS-MODBUS/IL/BK - 2310808

Classifications

UNSPSC

UNSPSC 6.01	30211802
UNSPSC 7.0901	39121402
UNSPSC 11	39121402
UNSPSC 12.01	39121402
UNSPSC 13.2	39121402

Drawings

Dimensioned drawing

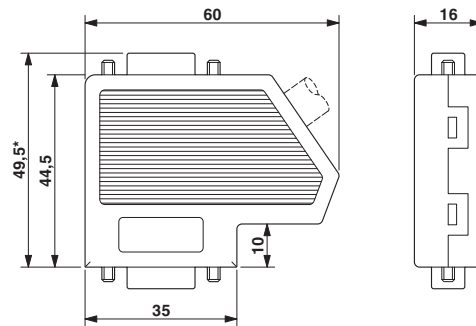

Looking for pricing, stock, or lifecycle information?

Click below to explore more details on WIN SOURCE:

 [View 1689271 on WIN SOURCE](#)

 [Phoenix Contact Information](#)

Optimize Your Supply Chain with WIN SOURCE Solutions

-  Global Sourcing Solution
-  Obsolete Management
-  Cost Control Management
-  Shortage Management
-  Alternative Solution
-  Excess Inventory Management