



THE DATASHEET OF
1519778



SACC-EC-FS-8CON-M16/0,5 SCO

Order No.: 1523489

<http://eshop.phoenixcontact.de/phoenix/treeViewClick.do?UID=1523489>

Sensor/Actuator flush-type socket, 8-pos., M12-SPEEDCON, A-coded, front/screw mounting with M16 thread, can be positioned, with 0.5 m TPE litz wire, 8 x 0.25 mm²



Commercial data	
GTIN (EAN)	 4 046356 021319
sales group	D125
Pack	1 pcs.
Customs tariff	85444290
Catalog page information	Page 25 (PC-2009)

Product notes

WEEE/RoHS-compliant since:
08/09/2006



<http://www.download.phoenixcontact.com>
Please note that the data given here has been taken from the online catalog. For comprehensive information and data, please refer to the user documentation. The General Terms and Conditions of Use apply to Internet downloads.

Technical data**General data**

Rated current at 40°C	2 A
Rated voltage	30 V
Number of positions	8
Volume resistance	≤ 3 mΩ

Insulation resistance	≥ 100 MΩ
Length of cable	0.5 m
Ambient temperature (operation)	-25 °C ... 85 °C (Male connector / female connector)

General characteristics

Standards/regulations	M12 connector IEC 61076-2-101
Coding	A - standard
Surge voltage category	II
Pollution degree	3
Degree of protection	IP67
Contact material	CuZn
Contact surface material	Au
Contact carrier material	PA 66
Material, knurls	Zinc die-cast, (nickel-plated)
Sealing material	NBR
Mounting type	Front mounting M16 x 1.5 With locking nut
Type of connection	Individual wires
Status display	No

Conductor data

Cable type	TPE litz wire
Conductor cross section	0.25 mm ²
AWG signal line	24
Conductor structure signal line	14x 0.15 mm
Core diameter including insulation	1.15 mm ±0.07 mm
Thickness, insulation	0.21 mm (Core insulation)
Wire colors	Brown, blue, white, gray, pink, green, yellow, red
Insulation resistance	≥ 20 MΩ*km
Conductor resistance	≤ 80 mΩ/m
Nominal voltage, conductor	300 V
Test voltage, conductor	2000 V AC
Material conductor insulation	TPE
Conductor material	Tin-plated Cu litz wires
Ambient temperature (operation)	-25 °C ... 90 °C (cable, fixed installation)

Certificates / Approvals



Certification

UL

Diagrams/Drawings

Dimensioned drawing

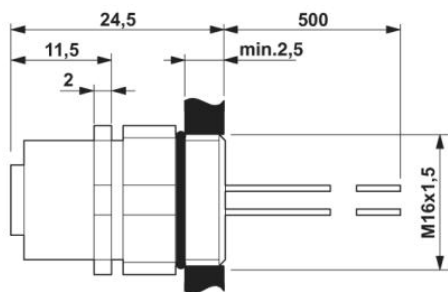

M12 flush-type socket, can be positioned

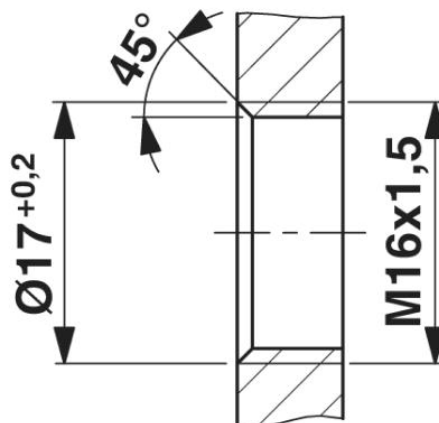

Housing cutout for M16 fastening thread, mounting panel with thread

Circuit diagram

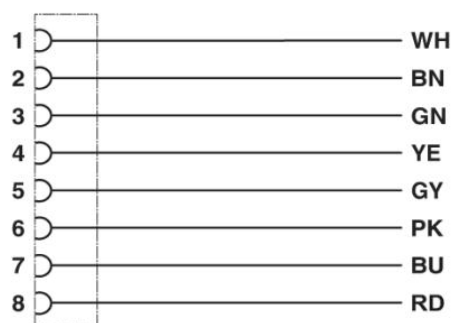

Contact assignment of the M12 socket

Schematic diagram

Pin assignment M12 socket, 8-pos., A-coded, view female side

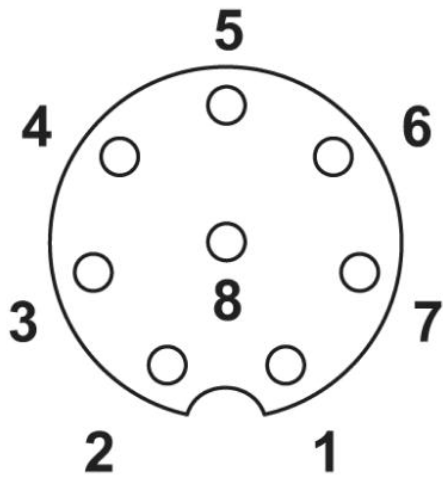

Address

PHOENIX CONTACT Inc., USA
586 Fulling Mill Road
Middletown, PA 17057, USA
Phone (800) 888-7388
Fax (717) 944-1625
<http://www.phoenixcon.com>



© 2010 Phoenix Contact
Technical modifications reserved;

Looking for pricing, stock, or lifecycle information?

Click below to explore more details on WIN SOURCE:

 [View 1519778 on WIN SOURCE](#)

 [Phoenix Contact Information](#)

Optimize Your Supply Chain with WIN SOURCE Solutions

-  Global Sourcing Solution
-  Obsolete Management
-  Cost Control Management
-  Shortage Management
-  Alternative Solution
-  Excess Inventory Management