



THE DATASHEET OF
1300990107



The copying, distribution and utilization of this document as well as the communication of the contents to others without expressed authorization is prohibited according to §18 UWG German Law. Offenders will be held liable for the payment of damages according to §19 UWG German Law. All rights reserved, in particular the right to carry out patent, utility model or ornamental design registrations.

Mechanical data (according to IEC 61076-2-101)		Material	
no. of poles / coding	4 / A	housing	V4A
contact termination	crimp / pin	contact carrier	PA 66 / UL 94 V0
contact-Ø	1mm	colour	black
temperature range	-40 °C / +85 °C	wire	TPE
protection class	IP 67	cross section	0,34mm ²
mating cycles	>100	contacts / surface	CuZn / Au
locking system	M12 STANDARD	sealing gasket	FKM
		potting	PU 2k / UL 94 V0

further information:
 - see technical data M12-1
 - see installation recommendation PG9 design DSI

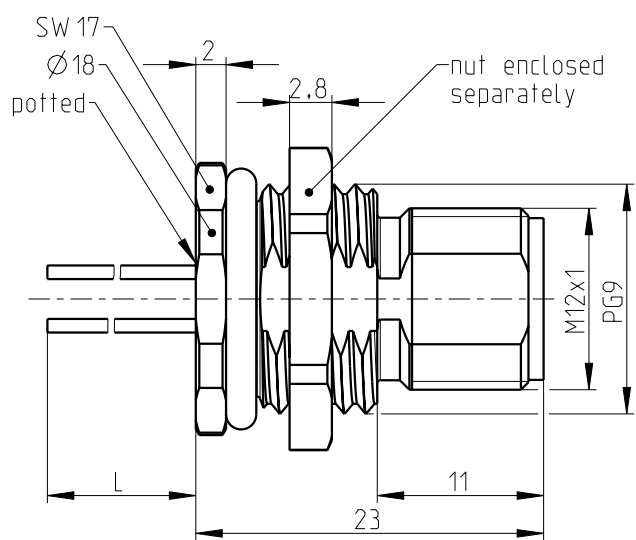
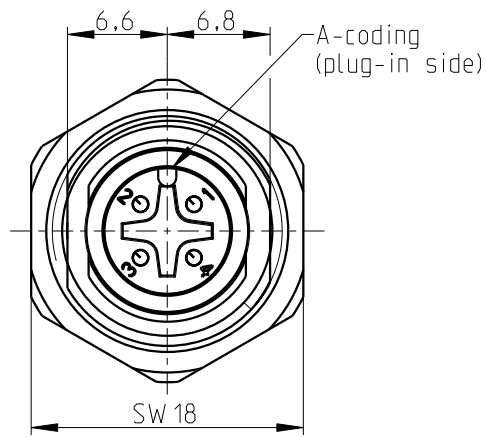

All specified data refers to the mounted M12 installation plugs ≥ IP54 and requires that the connector pair be correctly plugged and locked. Influences from wires, cables or PCB mounting are also to be taken into consideration.

Weitergabe sowie Vervielfältigung dieses Dokuments, Verwertung und Mitteilung seines Inhalts gem §18 UWG verboten, soweit nicht ausdrücklich gestattet. Zuwiderhandlungen verpflichten zu Schadensersatz (§19 UWG). Alle Rechte vorbehalten, insbesondere das Recht, Patent-, Gebrauchsmuster- oder Geschmacksmusteranmeldungen durchzuführen. CONIVERS GmbH Heisenbergstrasse 1 D-71083 Herrenberg

View of pin assignment
Plug-in side

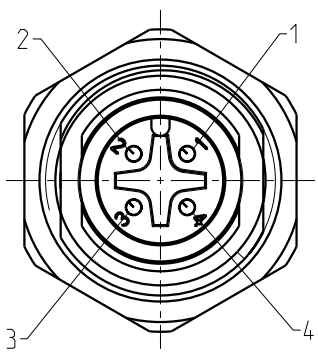

Pin layout

pin	colour
1	brown
2	white
3	blue
4	black

order-no.	L (m)
1405239	0,5

general tolerance acc. to DIN ISO 2768-c		technical changes reserved		Index 1 / 2011-11-30		scale: 2:1	
design	date	name	description: Housing with crimp contacts Rear mounting (PG9)	page: 1 of: 1			
chk.	2011-11-30	Thumm					
		drawing-no.:	BA-L11RVC0BX,XX (X,XX=L)				
		order-no.:	see chart				
		article designation:	SACC-DSI-M12MS-4CON-PG9/L (see chart) VA				

Looking for pricing, stock, or lifecycle information?

Click below to explore more details on WIN SOURCE:

 [View 1300990107 on WIN SOURCE](#)

 [Molex, LLC Information](#)

Optimize Your Supply Chain with WIN SOURCE Solutions

-  Global Sourcing Solution
-  Obsolete Management
-  Cost Control Management
-  Shortage Management
-  Alternative Solution
-  Excess Inventory Management