

MPU IMU click™

1. Introduction

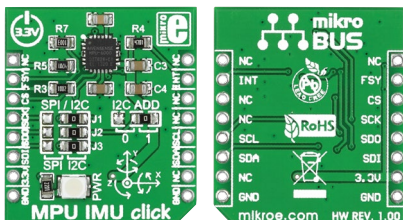

MPU IMU click is an add-on board in mikroBUS™ form factor. It carries the MPU-6000, the integrated 6-axis motion tracking device from InvenSense. The MPU-6000 is the world's first to combine a 3-axis gyroscope, a 3-axis accelerometer, and a Digital Motion Processor (DMP) into a single small chip. Together they constitute an Inertial Measurement Unit. The MPU IMU click communicates with the target board microcontroller through mikroBUS™ SPI, I2C, RST and INT lines. The board is designed to use a 3.3V power supply only. A LED diode serves as a power indicator.

2. Soldering the headers

Before using your click™ board, make sure to solder 1x8 male headers to both left and right side of the board. Two 1x8 male headers are included with the board in the package.

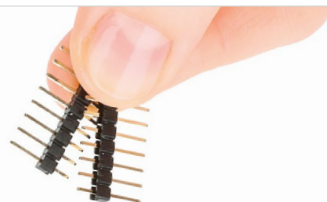

1

2

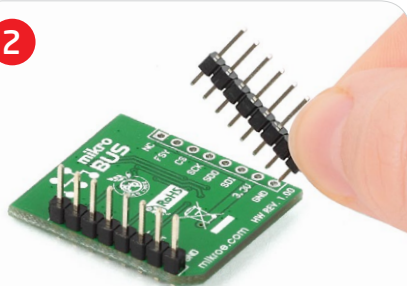

Turn the board upside down so that the bottom side is facing you upwards. Place shorter pins of the header into the appropriate soldering pads.

3

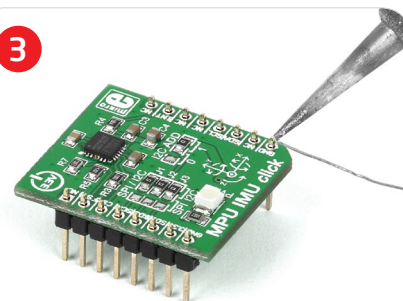

Turn the board upward again. Make sure to align the headers so that they are perpendicular to the board, then solder the pins carefully.

3. Plugging the board in

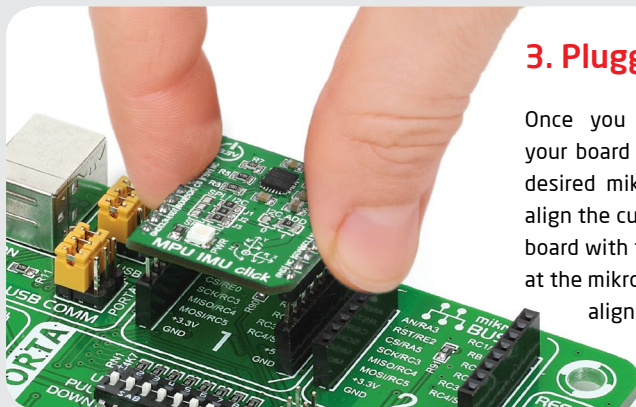

Once you have soldered the headers your board is ready to be placed into the desired mikroBUS™ socket. Make sure to align the cut in the lower-right part of the board with the markings on the silkscreen at the mikroBUS™ socket. If all the pins are aligned correctly, push the board all the way into the socket.

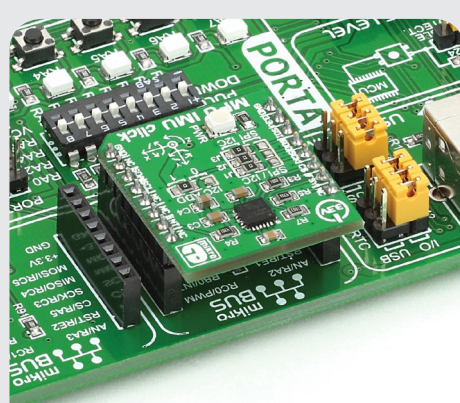

4. Essential features

The MPU IMU click offers a single solution for adding motion tracking to your design. The on-board MPU-6000 combines a DMP with a 3-axis gyro with a sensitivity up to 131 LSBs/dps and a full-scale range of ±250, ±500, ±1000, and ±2000dps; and a 3-axis accelerometer with a programmable full scale range of ±2g, ±4g, ±8g and ±16g. These features make this board ideal for applications like motion-based remote controls, wearable fitness and sports gadgets, toys etc.

click™
BOARD
www.mikroe.com



MPU IMU click Manual
ver. 1.00



0 100000 025994

5. MPU IMU click™ Board Schematic

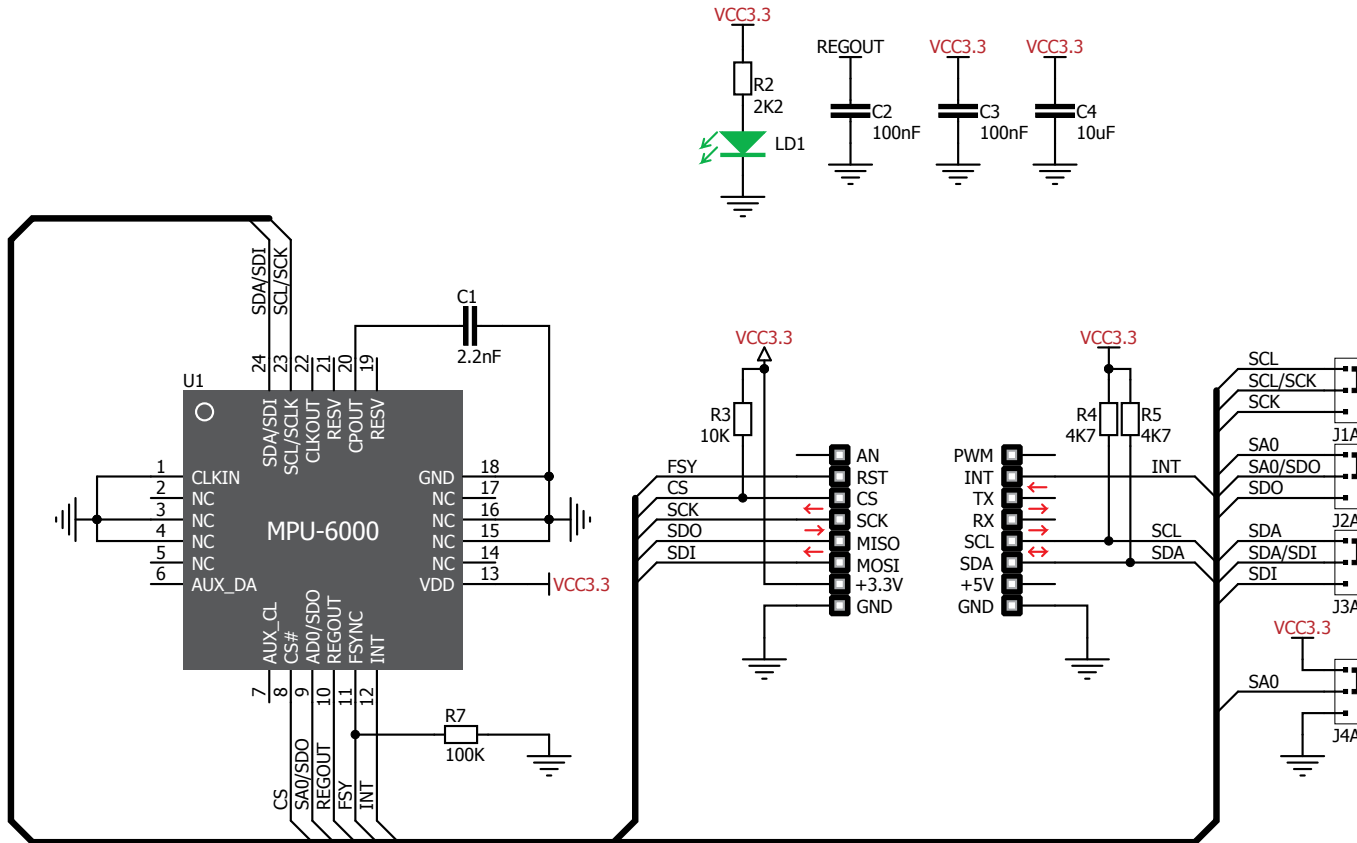

6. Motion Processing

The internal Digital Motion Processing engine supports 3D MotionProcessing and gesture recognition algorithms. Panning, zooming, scrolling, zero-motion detection, shake detection and tap detection are among the many features supported by programmable interrupt. There's also a low-power pedometer functionality that allows the target board's MCU to sleep while the DMP maintains the step count.

7. Code Examples

Once you have done all the necessary preparations, it's time to get your click™ board up and running. We have provided examples for mikroC™, mikroBasic™ and mikroPascal™ compilers on our **Libstock** website. Just download them and you are ready to start.



8. Support

MikroElektronika offers **Free Tech Support** (www.mikroe.com/support/) until the end of the product's lifetime, so if something goes wrong, we're ready and willing to help!

Looking for pricing, stock, or lifecycle information?

Click below to explore more details on WIN SOURCE:

 [View D7H-B2 on WIN SOURCE](#)

 [Omron Information](#)

Optimize Your Supply Chain with WIN SOURCE Solutions

-  Global Sourcing Solution
-  Obsolete Management
-  Cost Control Management
-  Shortage Management
-  Alternative Solution
-  Excess Inventory Management