



**THE DATASHEET OF
TPS92411EVM-001**



TPS92411EVM-002 Offline LED Driver Evaluation Module

User's Guide



Literature Number: SLVUA08

December 2013

1	Introduction	4
2	Warnings and Cautions	4
3	Description	5
	3.1 Typical Applications	5
	3.2 Connector Descriptions	5
4	Electrical Performance Specifications	6
5	TPS92411EVM-002 Schematic	7
6	Performance Data and Typical Characteristic Curves	8
	6.1 Power Factor	8
	6.2 Line Regulation	8
	6.3 Input Voltage and Input Current	9
	6.4 Linear Regulator Drain Voltage and Input Current	9
	6.5 Triac Dimming Waveforms	10
	6.6 EMI Performance	13
7	TPS92411EVM-002 PCB Layout	14
8	Bill of Materials	15

List of Figures

1	TPS92411EVM-002 Schematic	7
2	Power Factor Versus Input Voltage	8
3	Input (Linear Regulator) Current Versus Input Voltage	8
4	Input Voltage (Top) and Input Current (Bottom)	9
5	Drain Voltage (Top) and Input Current (Bottom)	9
6	Forward Phase Triac Dimming: Rectified Input Voltage (Top) and Input Current (Bottom)	10
7	Forward Phase Triac Dimming: Rectified Input Voltage (Top) and Input Current (Bottom)	10
8	Forward Phase Triac Dimming: Rectified Input Voltage (Top) and Input Current (Bottom)	11
9	Reverse Phase Triac Dimming: Rectified Input Voltage (Top) and Input Current (Bottom)	11
10	Reverse Phase Triac Dimming: Rectified Input Voltage (Top) and Input Current (Bottom)	12
11	Reverse Phase Triac Dimming: Rectified Input Voltage (Top) and Input Current (Bottom)	12
12	Conducted EMI Performance	13
13	Top Layer and Top Overlay (Top View)	14
14	Bottom Layer and Bottom Overlay (Bottom View)	14

List of Tables

1	TPS92411EVM-002 Electrical Performance Specifications	6
2	TPS92411EVM-002 Bill of Materials	15

Switch Controlled Direct Drive Switch for Offline LED Drivers

1 Introduction

The TPS92411EVM-002 evaluation module (EVM) helps designers evaluate the operation and performance of the TPS92411P direct drive switch designed for use with a linear regulator in offline LED drive applications. The TPS92411P is designed to control the drive of high-brightness light emitting diodes (LEDs) and features a wide input voltage range (7.5 V to 100 V) and overvoltage protection.

2 Warnings and Cautions

Observe the following precautions when using the TPS92411EVM-002.

CAUTION



DO NOT STARE DIRECTLY INTO THE LED LIGHT SOURCE.

Intense light sources have a high secondary blinding effect. A temporary reduction in visual acuity and afterimages can occur, leading to irritation, annoyance, visual impairment, and even accidents – depending on the situation. Always consider the use of light filtering and darkening protective eyewear and be fully aware of surrounding laboratory type set-ups when viewing intense light sources to minimize or eliminate such risks in order to avoid accidents related to temporary blindness.

WARNING



Do not stare at the operating LED – (Risk Group 1 (RG1)). See IEC32471-1 ed1.0:2009-08 for risk group definitions.

3 Description

The TPS92411EVM-002 provides a high-brightness LED driver based on the TPS92411P in conjunction with a discrete linear regulator. It is designed to operate with an input voltage in the range of 190 VAC to 260 VAC with a 230-VAC nominal input voltage. This input voltage range is typical for offline applications. The EVM is set up for a default input current of 70 mA for 16 W total power and 3 LED voltage stacks of 40 V, 80 V, and 160 V. The TPS92411 helps provide high LED utilization, good power factor, low THD, and flicker free dimming.

3.1 Typical Applications

This converter design describes an application of the TPS92411P as an LED driver controller with the specifications listed below. For applications with a different input voltage range or different output voltage range refer to the TPS92411 datasheet.

3.2 Connector Descriptions

This section describes the connectors and test points on the EVM and how to properly connect, setup, and use the TPS92411EVM-002.

3.2.1 J1

The screw down connector J1 is for the input voltage supply to the LED driver. The leads to the input supply should be twisted and kept as short as possible to minimize voltage drop, inductance, and EMI transmission. The input is not polarized. Line and neutral may be connected to either terminal.

3.2.2 VPx, VSx, ISx

The test points VP1, VS1, IS1, VP2, VS2, IS2, VP3, VS3, and IS3 are for testing the different LED stack voltages and currents. For example, connect a voltmeter from VP1 to IS1 across the 1- Ω resistor R24 to measure the current in the top (160 V) LED string (1 mV = 1 mA). Connect a voltmeter from VP1 to VS1 to measure the top stack voltage. The middle and lower stack currents and voltages can be measured in the same way using the test points labeled with 2 and 3, respectively.

4 Electrical Performance Specifications

Table 1 contains the electrical performance specifications for the EVM.

Table 1. TPS92411EVM-002 Electrical Performance Specifications

Parameter	Test Conditions	MIN	TYP	MAX	Units
Input Characteristics					
Voltage range		190	230	260	VAC
Maximum input current		64	72	80	mA
Output Characteristics					
Output voltage, VOUT	Upper LED stack		160		V
	Middle LED stack		80		
	Lower LED stack		40		
Flicker Index			0.06		
Output current ripple percent			23		%
Output current ripple	Each stack		30		mApp
Overvoltage protection level	Each individual TPS92411P		100		V
Systems Characteristics					
Efficiency	Input voltage = 230 VAC, No triac dimmer		77		%
Power Factor	Input voltage = 230 VAC, No triac dimmer		0.966		
THD	Input voltage = 230 VAC, No triac dimmer		16.6		%

5 TPS92411EVM-002 Schematic

Figure 1 illustrates the TPS92411EVM-002 schematic.

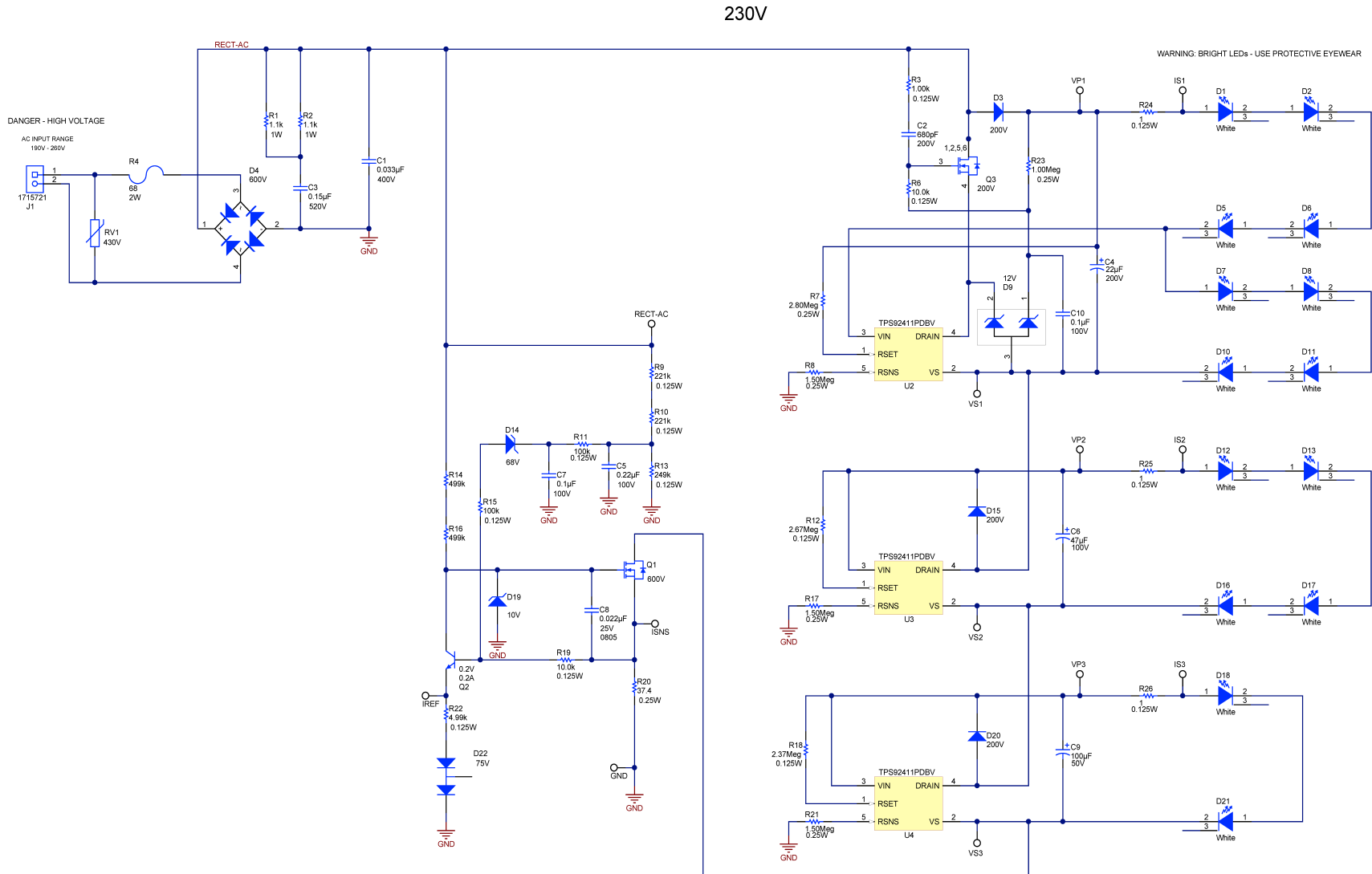

Figure 1. TPS92411EVM-002 Schematic

6 Performance Data and Typical Characteristic Curves

Figure 2 through Figure 11 present typical performance curves for TPS92411EVM-002.

6.1 Power Factor

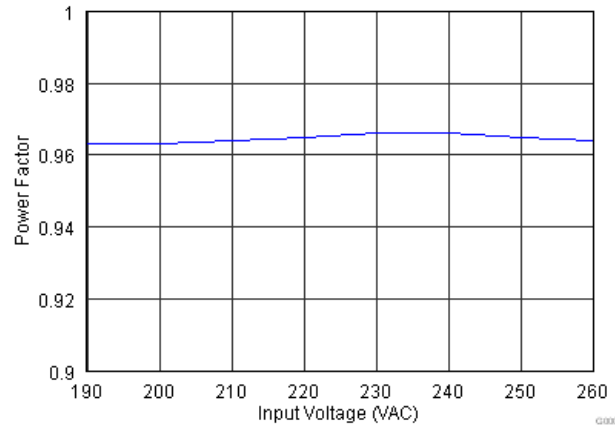

Figure 2. Power Factor Versus Input Voltage

6.2 Line Regulation

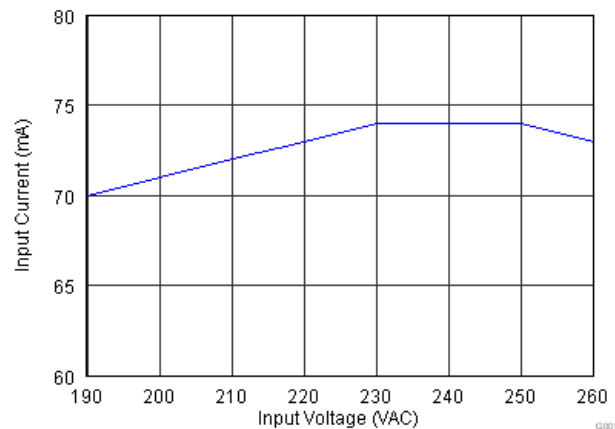

Figure 3. Input (Linear Regulator) Current Versus Input Voltage

6.3 Input Voltage and Input Current

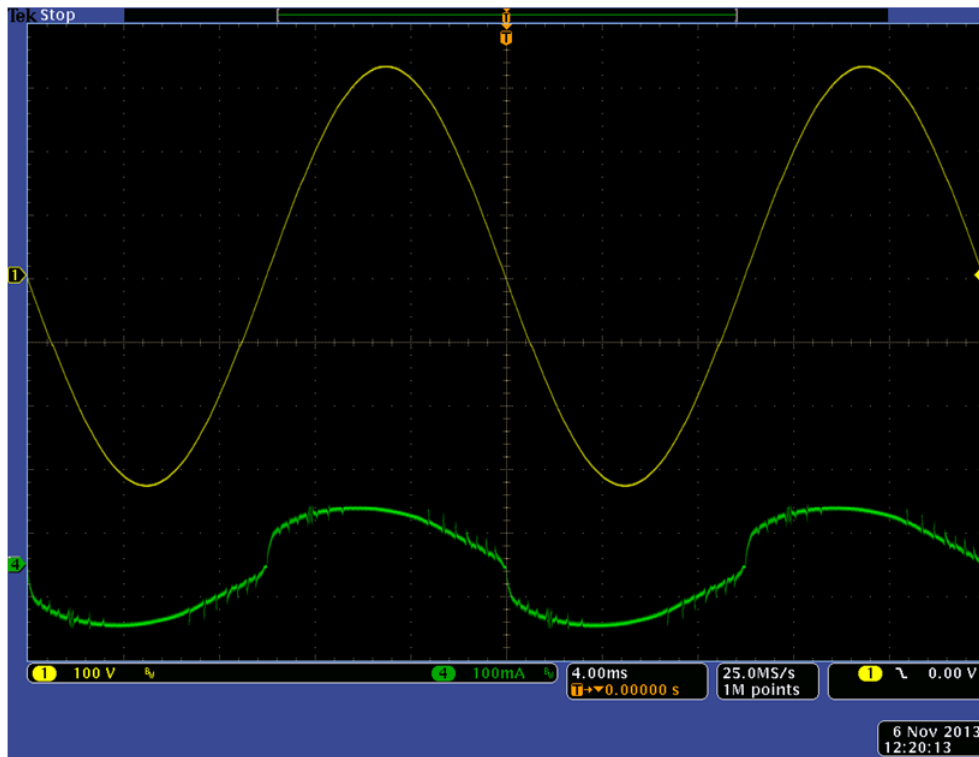

Figure 4. Input Voltage (Top) and Input Current (Bottom)

6.4 Linear Regulator Drain Voltage and Input Current

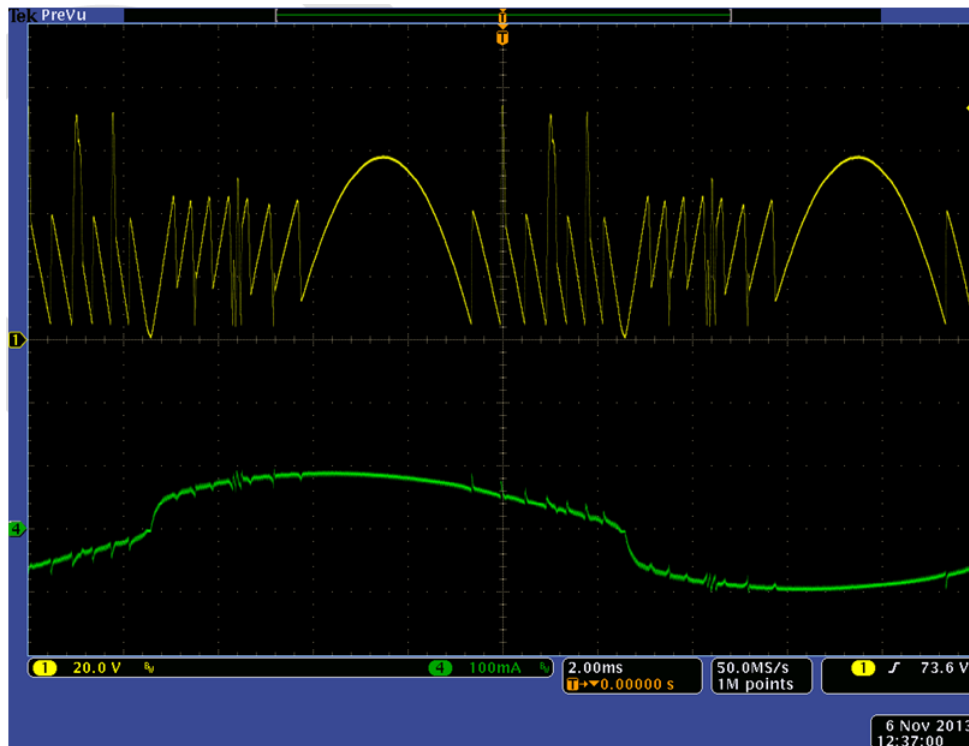

Figure 5. Drain Voltage (Top) and Input Current (Bottom)

6.5 Triac Dimming Waveforms

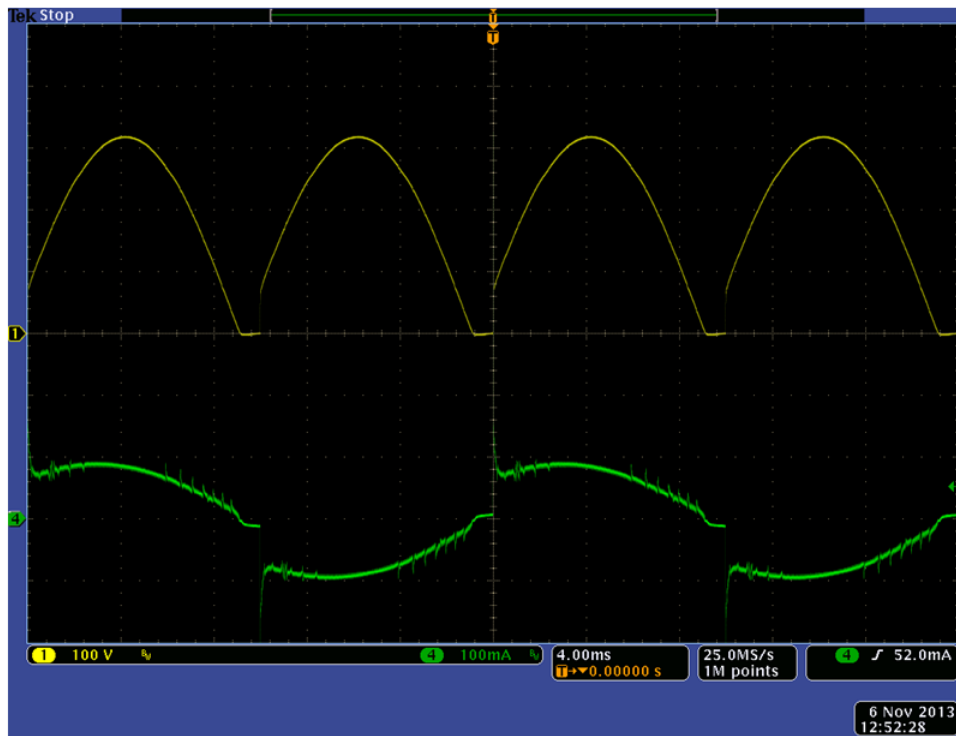

Figure 6. Forward Phase Triac Dimming: Rectified Input Voltage (Top) and Input Current (Bottom)

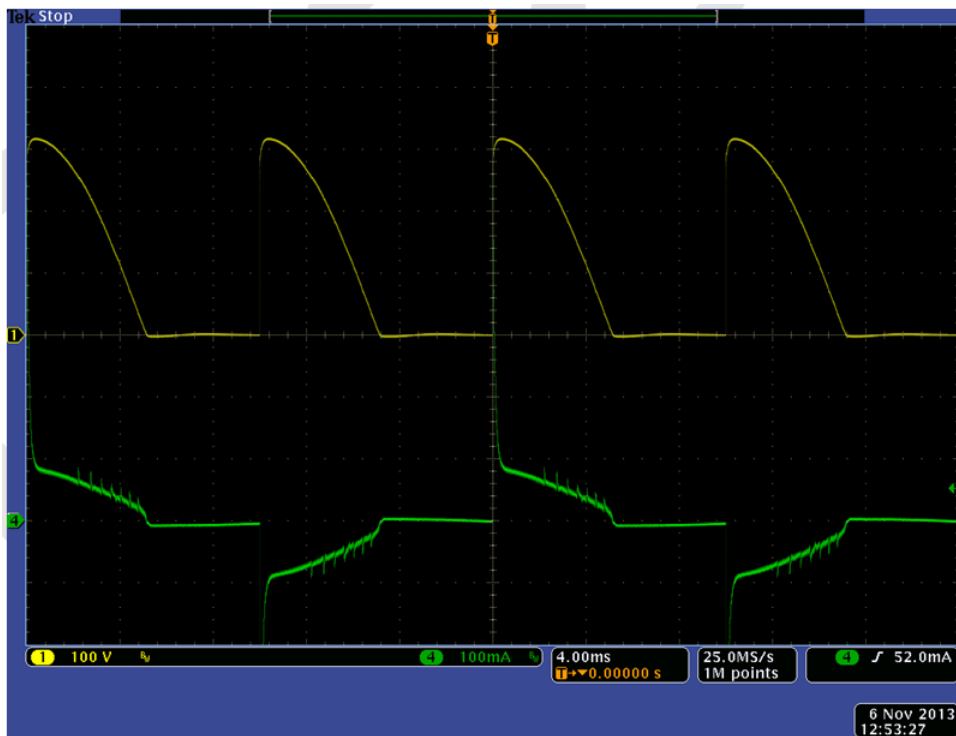

Figure 7. Forward Phase Triac Dimming: Rectified Input Voltage (Top) and Input Current (Bottom)

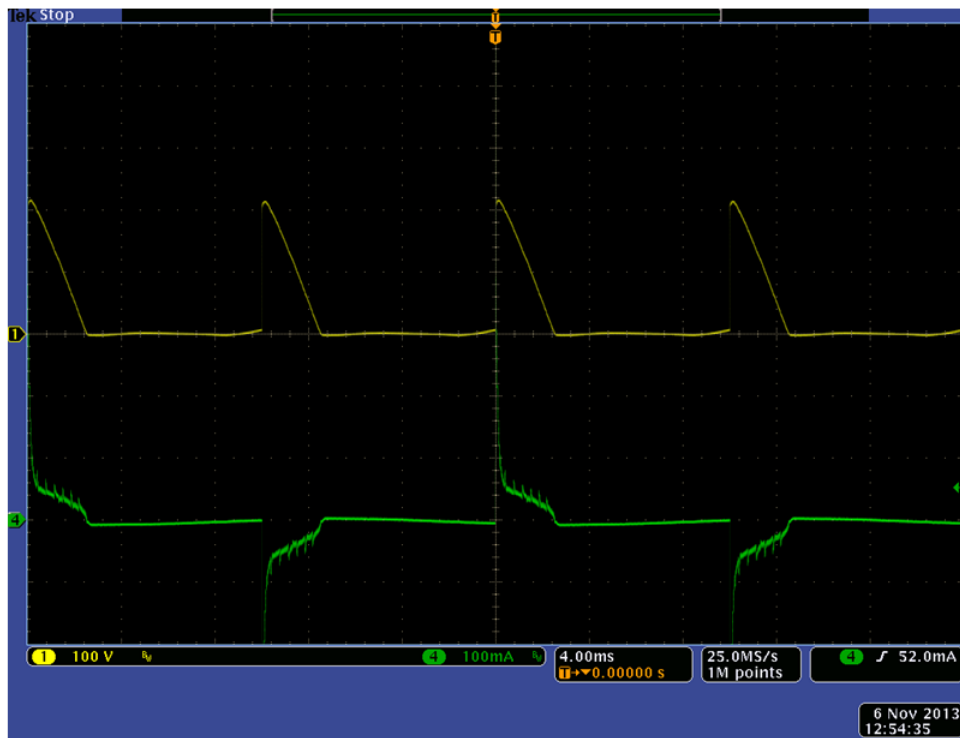

Figure 8. Forward Phase Triac Dimming: Rectified Input Voltage (Top) and Input Current (Bottom)

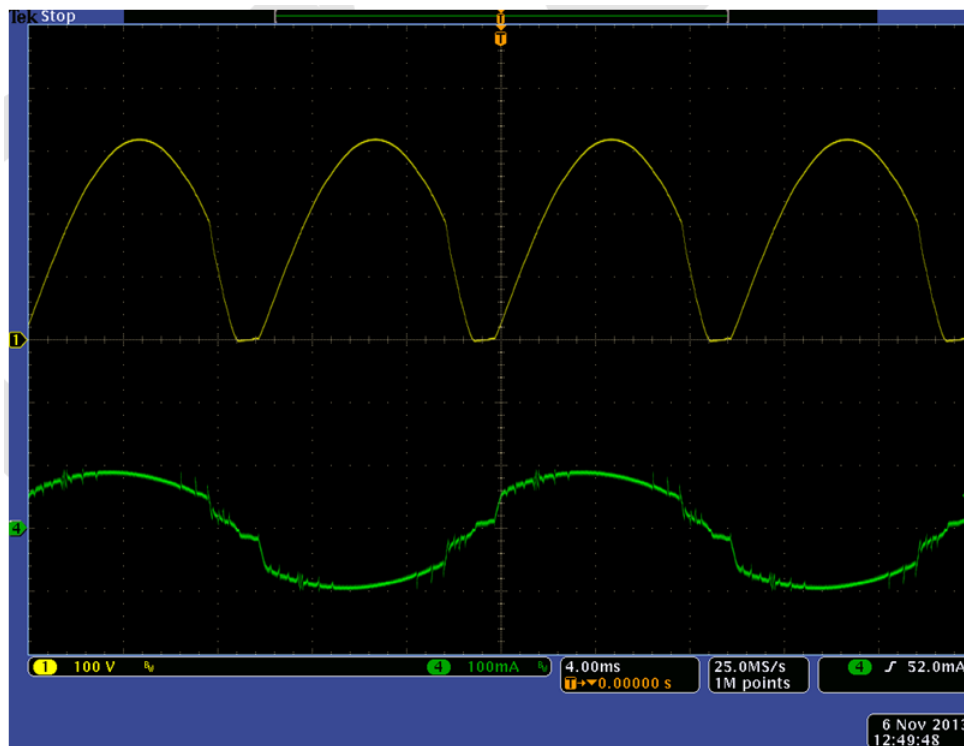

Figure 9. Reverse Phase Triac Dimming: Rectified Input Voltage (Top) and Input Current (Bottom)

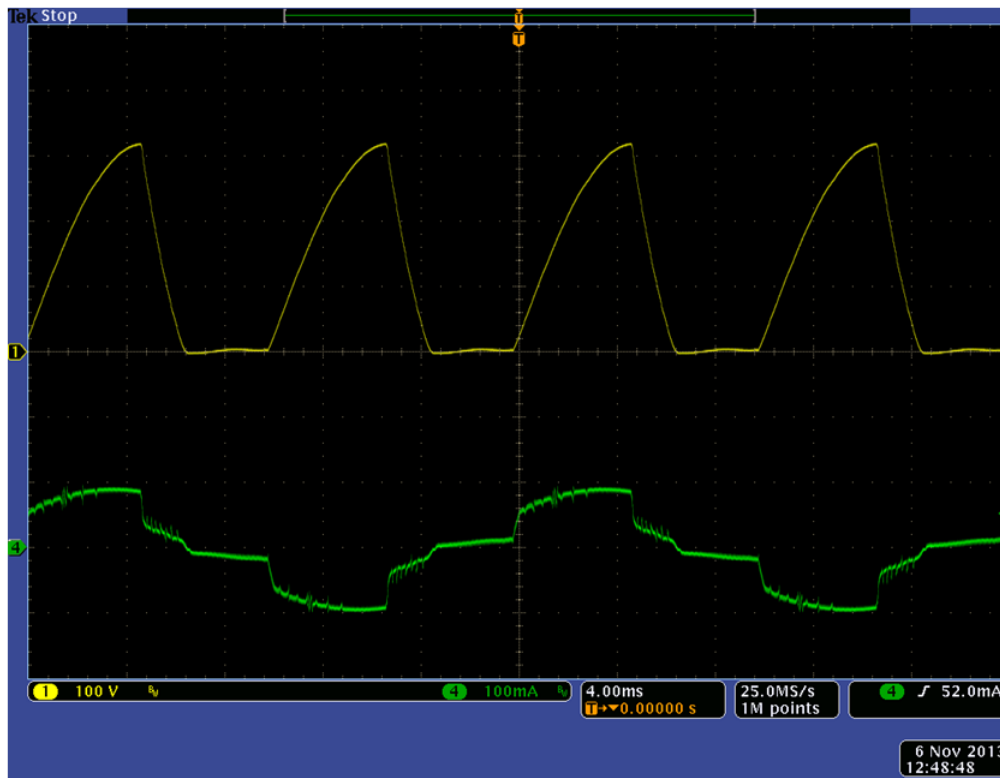

Figure 10. Reverse Phase Triac Dimming: Rectified Input Voltage (Top) and Input Current (Bottom)

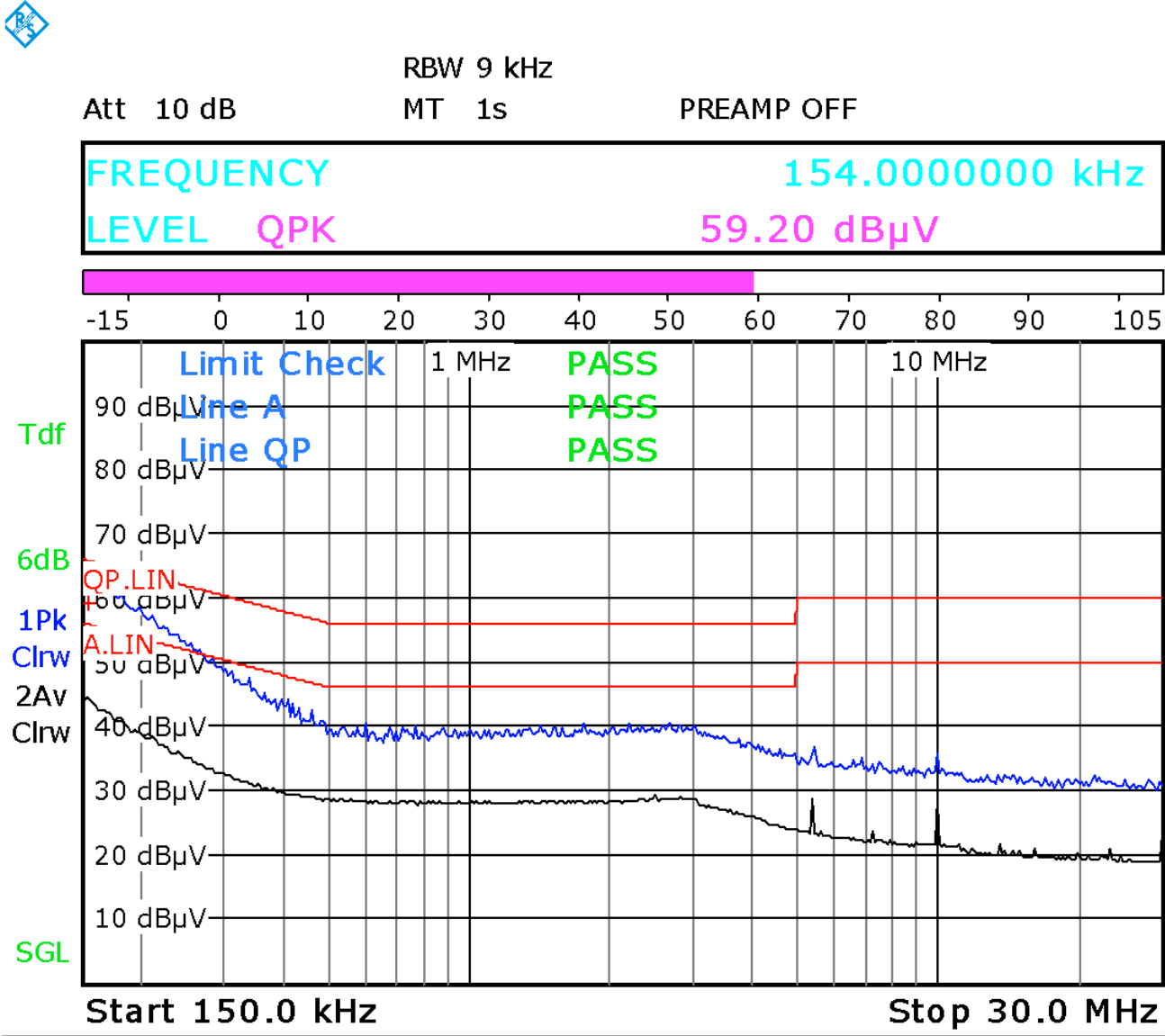

Figure 11. Reverse Phase Triac Dimming: Rectified Input Voltage (Top) and Input Current (Bottom)

6.6 EMI Performance

Figure 12 shows the conducted EMI performance of the EVM under the following conditions:

- $P_{IN} = 16\text{ W}$
- $V_{IN} = 230\text{ VAC}$
- QP = quasi-peak limit line
- A = average limit line
- Blue trace = peak scan
- Black trace = average scan



Date: 6.NOV.2013 00:52:38

Figure 12. Conducted EMI Performance

7 TPS92411EVM-002 PCB Layout

Figure 13 and Figure 14 show the design of the TPS92411EVM-002 printed circuit board.

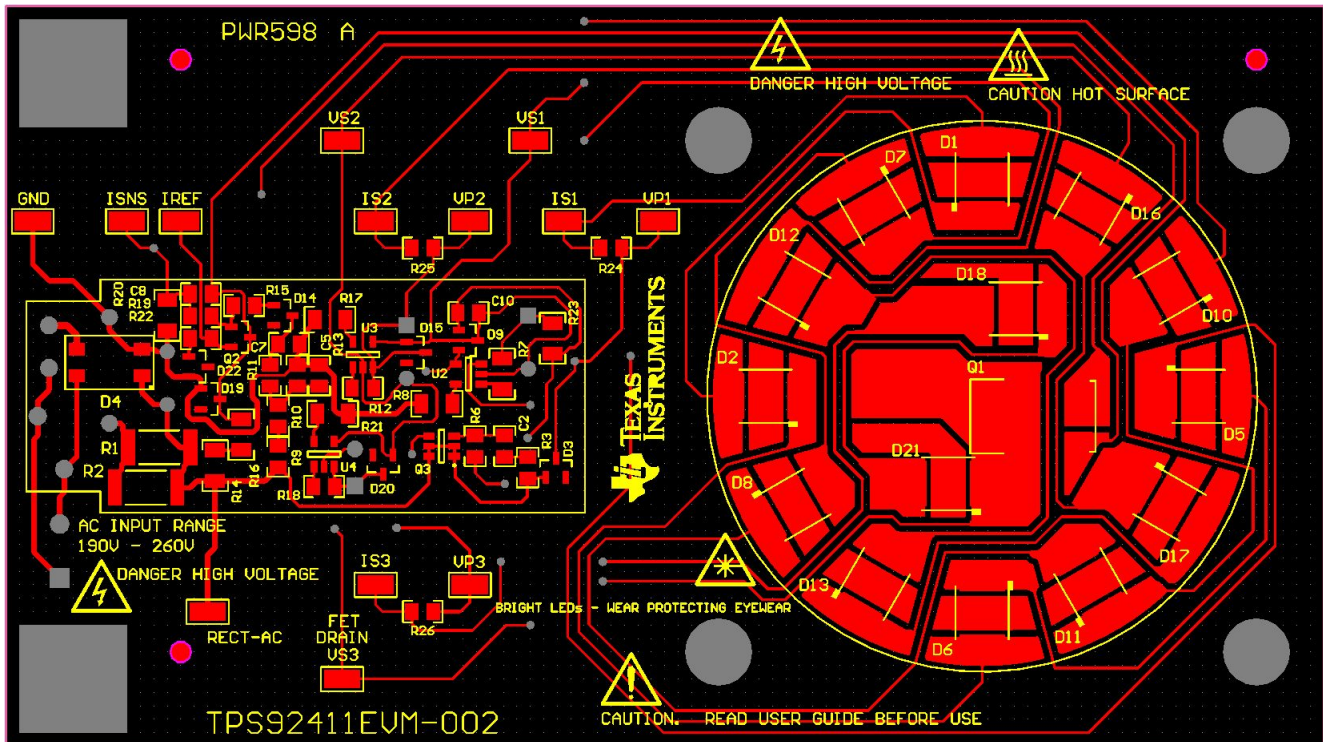

Figure 13. Top Layer and Top Overlay (Top View)

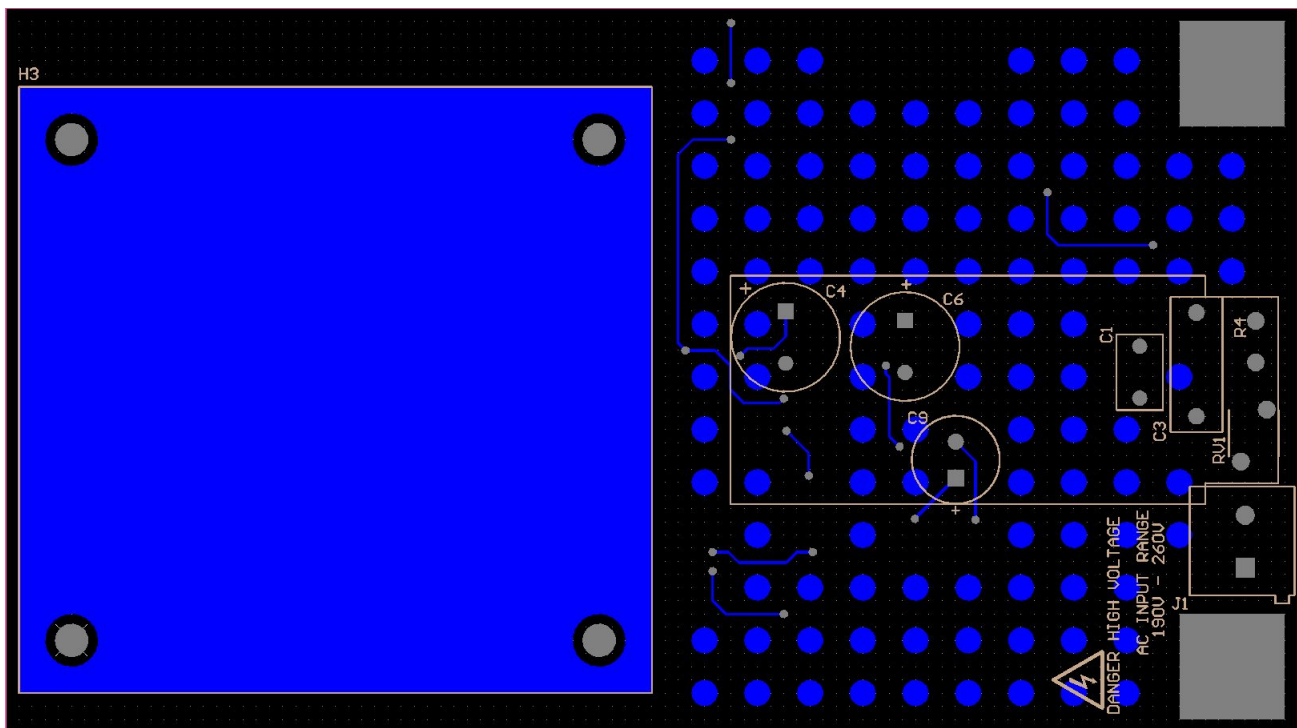

Figure 14. Bottom Layer and Bottom Overlay (Bottom View)

8 Bill of Materials

Table 2 contains the TPS92411EVM-002 components list according to the schematic shown in Figure 1.

Table 2. TPS92411EVM-002 Bill of Materials

Reference Designator	QTY	Value	Description	Size	Part Number	MFR
C1	1	0.033µF	CAP, Film, 0.033µF, 400V, Radial	Radial	B32529C6333J289	EPCOS Inc.
C2	1	680pF	CAP, CERM, 680pF, 200V, X7R, 10%	0805	CC0805KRX7RABB681	Yageo
C3	1	0.15µF	CAP, Film, 0.15µF, 520V, Radial	Radial	B32671P5154K	EPCOS Inc.
C4	1	22µF	CAP, Alum, 22µF, 200V, +/-20%, Radial	Radial, Can	UPW2D220MPD	Nichicon
C5	1	0.22µF	CAP, CERM, 0.22µF, 100V, X7R, 10%	0805	CL21B224KCFSNWE	Samsung Electro-Mechanics
C6	1	47µF	CAP, Alum, 47µF, 100V, +/-20%, Radial	Radial, Can	UHE2A470MPD	Nichicon
C7, C10	2	0.1µF	CAP, CERM, 0.1µF, 250V, X7R, 10%	0805	CL21B104KCFSFNE	Samsung Electro-Mechanics
C8	1	0.022µF	CAP, CERM, 0.022µF, 25V, +/-5%, C0G/NP0	0805	C2012C0G1E223J	TDK
C9	1	100µF	CAP, Alum, 100µF, 50V, +/-20%, Radial	Radial, Can	UHE1H101MPD	Nichicon
D1, D2, D5, D6, D7, D8, D10, D11, D12, D13, D16, D17, D18, D21	14	XLamp MX-6S	LED, SMT, Warm White, XLamp MX-6S	2-SMD, Gull Wing Tabs	MX6SWT-A1-0000-000AE8	Cree Inc
D3, D15, D20	3	200V	Diode, Switching, 200V, 0.2A	SOT-23	BAS21-7-F	Diodes Inc.
D4	1		Diode, Switching-Bridge, 600V, 0.8A, MiniDIP	MiniDIP	HD06-T	Diodes Inc.
D9	1		Diode, Zener, Dual, 12V	SOT-23		
D14	1	900mV @ 10mA	Diode, Zener, 68V, 225mW	SOT-23	BZX84C68LT1G	ON Semiconductor
D19	1	900mV @ 10mA	Diode, Zener, 10V, 225mW	SOT-23	BZX84C10LT1G	ON Semiconductor
D22	1	1.25V @ 150mA	Diode, 75V, 0.3A	SOT-23	BAV99-7-F	Diodes Inc.
H3	1		HEATSINK DC/DC HALF BRICK VERT		518-95AB	Wakefield Thermal Solutions
J1	1		Header, Term Blk, 2Pos, 5.08mm, TH	2POS Terminal Block	1715721	Phoenix Contact
Q1	1	600V	MOSFET, N-CH, 600V, 2	TO-252-3, DPak	AOD2N60	Alpha & Omega Semiconductor Inc
Q2	1	0.2V	Transistor, NPN, 40V, 0.2A	SOT-23	MMBT3904-7-F	Diodes Inc
Q3	1		MOSFET, N-CH, 200V, 600mA	6-TSOP	IRF5801TRPBF	International Rectifier
R1, R2	2	1.1k	RES, 1.1k ohm, 5%, 1W	2512 (6432 Metric)	CRCW25121K10JNEG	Vishay-Dale
R3	1	1.00k	RES, 1.00k ohm, 1%, 0.125W	0805	CRCW08052M67FKEA	Vishay-Dale
R4	1	68	RES, 68 ohm, 10%, 2W, Fusible, Axial	Axial	EMC2-68RKI	TT Electronics/Welwyn
R6, R19	2	10.0k	RES, 10.0k ohm, 1%, 0.125W	0805	CRCW080510K0FKEA	Vishay-Dale
R7	1	2.80Meg	RES, 2.80Meg ohm, 1%, 0.25W	1206	CRCW12062M80FKEA	Vishay-Dale
R8, R17, R21	3	1.5Meg	RES, 1.5Meg ohm, 1%, 0.25W	1206	RC1206FR-071M5L	Yageo America
R9, R10	2	221k	RES, 221k ohm, 1%, 0.125W	0805	CRCW0805221KFKEA	Vishay-Dale
R11, R15	2	100k	RES, 100k ohm, 1%, 0.125W	0805	CRCW0805100KFKEA	Vishay-Dale
R12	1	2.67Meg	RES, 2.67Meg ohm, 1%, 0.125W	0805	CRCW08052M67FKEA	Vishay-Dale
R13	1	249k	RES, 249k ohm, 1%, 0.125W	0805	CRCW0805249KFKEA	Vishay-Dale
R14, R16	2	499k	RES, 499k ohm, 1%, 0.25W	1206	CRCW1206499KFKEA	Vishay-Dale
R18	1	2.37Meg	RES, 2.37Meg ohm, 1%, 0.125W	0805	CRCW08052N37FKEA	Vishay-Dale
R20	1	37.4	RES, 37.4 ohm, 1%, 0.25W	1206	CRCW120637R4FKEA	Vishay-Dale
R22	1	4.99k	RES, 4.99k ohm, 1%, 0.125W	0805	CRCW08054K99FKEA	Vishay-Dale
R23	1	1.00Meg	RES, 1.00Meg ohm, 1%, 0.25W	1206	CRCW12061M00FKEA	Vishay-Dale

Table 2. TPS92411EVM-002 Bill of Materials (continued)

Reference Designator	QTY	Value	Description	Size	Part Number	MFR
R24, R25, R26	3	1	RES, 1 ohm, 1%, 0.125W	0805	RMCF0805FT1R00	Stackpole Electronics Inc.
RV1	1		Varistor, 430V, 28J, 7MM, Radial	Disc 7mm	MOV-07D431K	Bourns Inc.
U2, U3, U4	4		Switch Controlled Direct Drive Switch for Offline LED Drivers, DBV0005A	SOT23-5	TPS92411PDBV	Texas Instruments

EVALUATION BOARD/KIT/MODULE (EVM) ADDITIONAL TERMS

Texas Instruments (TI) provides the enclosed Evaluation Board/Kit/Module (EVM) under the following conditions:

The user assumes all responsibility and liability for proper and safe handling of the goods. Further, the user indemnifies TI from all claims arising from the handling or use of the goods.

Should this evaluation board/kit not meet the specifications indicated in the User's Guide, the board/kit may be returned within 30 days from the date of delivery for a full refund. THE FOREGOING LIMITED WARRANTY IS THE EXCLUSIVE WARRANTY MADE BY SELLER TO BUYER AND IS IN LIEU OF ALL OTHER WARRANTIES, EXPRESSED, IMPLIED, OR STATUTORY, INCLUDING ANY WARRANTY OF MERCHANTABILITY OR FITNESS FOR ANY PARTICULAR PURPOSE. EXCEPT TO THE EXTENT OF THE INDEMNITY SET FORTH ABOVE, NEITHER PARTY SHALL BE LIABLE TO THE OTHER FOR ANY INDIRECT, SPECIAL, INCIDENTAL, OR CONSEQUENTIAL DAMAGES.

Please read the User's Guide and, specifically, the Warnings and Restrictions notice in the User's Guide prior to handling the product. This notice contains important safety information about temperatures and voltages. For additional information on TI's environmental and/or safety programs, please visit www.ti.com/esh or contact TI.

No license is granted under any patent right or other intellectual property right of TI covering or relating to any machine, process, or combination in which such TI products or services might be or are used. TI currently deals with a variety of customers for products, and therefore our arrangement with the user is not exclusive. TI assumes no liability for applications assistance, customer product design, software performance, or infringement of patents or services described herein.

REGULATORY COMPLIANCE INFORMATION

As noted in the EVM User's Guide and/or EVM itself, this EVM and/or accompanying hardware may or may not be subject to the Federal Communications Commission (FCC) and Industry Canada (IC) rules.

For EVMs **not** subject to the above rules, this evaluation board/kit/module is intended for use for ENGINEERING DEVELOPMENT, DEMONSTRATION OR EVALUATION PURPOSES ONLY and is not considered by TI to be a finished end product fit for general consumer use. It generates, uses, and can radiate radio frequency energy and has not been tested for compliance with the limits of computing devices pursuant to part 15 of FCC or ICES-003 rules, which are designed to provide reasonable protection against radio frequency interference. Operation of the equipment may cause interference with radio communications, in which case the user at his own expense will be required to take whatever measures may be required to correct this interference.

General Statement for EVMs including a radio

User Power/Frequency Use Obligations: This radio is intended for development/professional use only in legally allocated frequency and power limits. Any use of radio frequencies and/or power availability of this EVM and its development application(s) must comply with local laws governing radio spectrum allocation and power limits for this evaluation module. It is the user's sole responsibility to only operate this radio in legally acceptable frequency space and within legally mandated power limitations. Any exceptions to this are strictly prohibited and unauthorized by Texas Instruments unless user has obtained appropriate experimental/development licenses from local regulatory authorities, which is responsibility of user including its acceptable authorization.

For EVMs annotated as FCC – FEDERAL COMMUNICATIONS COMMISSION Part 15 Compliant

Caution

This device complies with part 15 of the FCC Rules. Operation is subject to the following two conditions: (1) This device may not cause harmful interference, and (2) this device must accept any interference received, including interference that may cause undesired operation.

Changes or modifications not expressly approved by the party responsible for compliance could void the user's authority to operate the equipment.

FCC Interference Statement for Class A EVM devices

This equipment has been tested and found to comply with the limits for a Class A digital device, pursuant to part 15 of the FCC Rules. These limits are designed to provide reasonable protection against harmful interference when the equipment is operated in a commercial environment. This equipment generates, uses, and can radiate radio frequency energy and, if not installed and used in accordance with the instruction manual, may cause harmful interference to radio communications. Operation of this equipment in a residential area is likely to cause harmful interference in which case the user will be required to correct the interference at his own expense.

FCC Interference Statement for Class B EVM devices

This equipment has been tested and found to comply with the limits for a Class B digital device, pursuant to part 15 of the FCC Rules. These limits are designed to provide reasonable protection against harmful interference in a residential installation. This equipment generates, uses and can radiate radio frequency energy and, if not installed and used in accordance with the instructions, may cause harmful interference to radio communications. However, there is no guarantee that interference will not occur in a particular installation. If this equipment does cause harmful interference to radio or television reception, which can be determined by turning the equipment off and on, the user is encouraged to try to correct the interference by one or more of the following measures:

- Reorient or relocate the receiving antenna.
- Increase the separation between the equipment and receiver.
- Connect the equipment into an outlet on a circuit different from that to which the receiver is connected.
- Consult the dealer or an experienced radio/TV technician for help.

For EVMs annotated as IC – INDUSTRY CANADA Compliant

This Class A or B digital apparatus complies with Canadian ICES-003.

Changes or modifications not expressly approved by the party responsible for compliance could void the user's authority to operate the equipment.

Concerning EVMs including radio transmitters

This device complies with Industry Canada licence-exempt RSS standard(s). Operation is subject to the following two conditions: (1) this device may not cause interference, and (2) this device must accept any interference, including interference that may cause undesired operation of the device.

Concerning EVMs including detachable antennas

Under Industry Canada regulations, this radio transmitter may only operate using an antenna of a type and maximum (or lesser) gain approved for the transmitter by Industry Canada. To reduce potential radio interference to other users, the antenna type and its gain should be so chosen that the equivalent isotropically radiated power (e.i.r.p.) is not more than that necessary for successful communication.

This radio transmitter has been approved by Industry Canada to operate with the antenna types listed in the user guide with the maximum permissible gain and required antenna impedance for each antenna type indicated. Antenna types not included in this list, having a gain greater than the maximum gain indicated for that type, are strictly prohibited for use with this device.

Cet appareil numérique de la classe A ou B est conforme à la norme NMB-003 du Canada.

Les changements ou les modifications pas expressément approuvés par la partie responsable de la conformité ont pu vider l'autorité de l'utilisateur pour actionner l'équipement.

Concernant les EVMs avec appareils radio

Le présent appareil est conforme aux CNR d'Industrie Canada applicables aux appareils radio exempts de licence. L'exploitation est autorisée aux deux conditions suivantes : (1) l'appareil ne doit pas produire de brouillage, et (2) l'utilisateur de l'appareil doit accepter tout brouillage radioélectrique subi, même si le brouillage est susceptible d'en compromettre le fonctionnement.

Concernant les EVMs avec antennes détachables

Conformément à la réglementation d'Industrie Canada, le présent émetteur radio peut fonctionner avec une antenne d'un type et d'un gain maximal (ou inférieur) approuvé pour l'émetteur par Industrie Canada. Dans le but de réduire les risques de brouillage radioélectrique à l'intention des autres utilisateurs, il faut choisir le type d'antenne et son gain de sorte que la puissance isotrope rayonnée équivalente (p.i.r.e.) ne dépasse pas l'intensité nécessaire à l'établissement d'une communication satisfaisante.

Le présent émetteur radio a été approuvé par Industrie Canada pour fonctionner avec les types d'antenne énumérés dans le manuel d'usage et ayant un gain admissible maximal et l'impédance requise pour chaque type d'antenne. Les types d'antenne non inclus dans cette liste, ou dont le gain est supérieur au gain maximal indiqué, sont strictement interdits pour l'exploitation de l'émetteur.

【Important Notice for Users of EVMs for RF Products in Japan】

This development kit is NOT certified as Confirming to Technical Regulations of Radio Law of Japan

If you use this product in Japan, you are required by Radio Law of Japan to follow the instructions below with respect to this product:

1. Use this product in a shielded room or any other test facility as defined in the notification #173 issued by Ministry of Internal Affairs and Communications on March 28, 2006, based on Sub-section 1.1 of Article 6 of the Ministry's Rule for Enforcement of Radio Law of Japan,
2. Use this product only after you obtained the license of Test Radio Station as provided in Radio Law of Japan with respect to this product, or
3. Use of this product only after you obtained the Technical Regulations Conformity Certification as provided in Radio Law of Japan with respect to this product. Also, please do not transfer this product, unless you give the same notice above to the transferee. Please note that if you could not follow the instructions above, you will be subject to penalties of Radio Law of Japan.

Texas Instruments Japan Limited
(address) 24-1, Nishi-Shinjuku 6 chome, Shinjuku-ku, Tokyo, Japan

<http://www.tij.co.jp>

【無線電波を送信する製品の開発キットをお使いになる際の注意事項】

本開発キットは技術基準適合証明を受けておりません。

本製品のご使用に際しては、電波法遵守のため、以下のいずれかの措置を取っていただく必要がありますのでご注意ください。

1. 電波法施行規則第6条第1項第1号に基づく平成18年3月28日総務省告示第173号で定められた電波暗室等の試験設備でご使用いただく。
2. 実験局の免許を取得後ご使用いただく。
3. 技術基準適合証明を取得後ご使用いただく。

なお、本製品は、上記の「ご使用にあたっての注意」を譲渡先、移転先に通知しない限り、譲渡、移転できないものとします。

上記を遵守頂けない場合は、電波法の罰則が適用される可能性があることをご留意ください。

日本テキサス・インスツルメンツ株式会社
東京都新宿区西新宿6丁目24番1号
西新宿三井ビル

<http://www.tij.co.jp>

EVALUATION BOARD/KIT/MODULE (EVM) WARNINGS, RESTRICTIONS AND DISCLAIMERS

For Feasibility Evaluation Only, in Laboratory/Development Environments. Unless otherwise indicated, this EVM is not a finished electrical equipment and not intended for consumer use. It is intended solely for use for preliminary feasibility evaluation in laboratory/development environments by technically qualified electronics experts who are familiar with the dangers and application risks associated with handling electrical mechanical components, systems and subsystems. It should not be used as all or part of a finished end product.

Your Sole Responsibility and Risk. You acknowledge, represent and agree that:

1. You have unique knowledge concerning Federal, State and local regulatory requirements (including but not limited to Food and Drug Administration regulations, if applicable) which relate to your products and which relate to your use (and/or that of your employees, affiliates, contractors or designees) of the EVM for evaluation, testing and other purposes.
2. You have full and exclusive responsibility to assure the safety and compliance of your products with all such laws and other applicable regulatory requirements, and also to assure the safety of any activities to be conducted by you and/or your employees, affiliates, contractors or designees, using the EVM. Further, you are responsible to assure that any interfaces (electronic and/or mechanical) between the EVM and any human body are designed with suitable isolation and means to safely limit accessible leakage currents to minimize the risk of electrical shock hazard.
3. Since the EVM is not a completed product, it may not meet all applicable regulatory and safety compliance standards (such as UL, CSA, VDE, CE, RoHS and WEEE) which may normally be associated with similar items. You assume full responsibility to determine and/or assure compliance with any such standards and related certifications as may be applicable. You will employ reasonable safeguards to ensure that your use of the EVM will not result in any property damage, injury or death, even if the EVM should fail to perform as described or expected.
4. You will take care of proper disposal and recycling of the EVM's electronic components and packing materials.

Certain Instructions. It is important to operate this EVM within TI's recommended specifications and environmental considerations per the user guidelines. Exceeding the specified EVM ratings (including but not limited to input and output voltage, current, power, and environmental ranges) may cause property damage, personal injury or death. If there are questions concerning these ratings please contact a TI field representative prior to connecting interface electronics including input power and intended loads. Any loads applied outside of the specified output range may result in unintended and/or inaccurate operation and/or possible permanent damage to the EVM and/or interface electronics. Please consult the EVM User's Guide prior to connecting any load to the EVM output. If there is uncertainty as to the load specification, please contact a TI field representative. During normal operation, some circuit components may have case temperatures greater than 60°C as long as the input and output are maintained at a normal ambient operating temperature. These components include but are not limited to linear regulators, switching transistors, pass transistors, and current sense resistors which can be identified using the EVM schematic located in the EVM User's Guide. When placing measurement probes near these devices during normal operation, please be aware that these devices may be very warm to the touch. As with all electronic evaluation tools, only qualified personnel knowledgeable in electronic measurement and diagnostics normally found in development environments should use these EVMs.

Agreement to Defend, Indemnify and Hold Harmless. You agree to defend, indemnify and hold TI, its licensors and their representatives harmless from and against any and all claims, damages, losses, expenses, costs and liabilities (collectively, "Claims") arising out of or in connection with any use of the EVM that is not in accordance with the terms of the agreement. This obligation shall apply whether Claims arise under law of tort or contract or any other legal theory, and even if the EVM fails to perform as described or expected.

Safety-Critical or Life-Critical Applications. If you intend to evaluate the components for possible use in safety critical applications (such as life support) where a failure of the TI product would reasonably be expected to cause severe personal injury or death, such as devices which are classified as FDA Class III or similar classification, then you must specifically notify TI of such intent and enter into a separate Assurance and Indemnity Agreement.

Mailing Address: Texas Instruments, Post Office Box 655303, Dallas, Texas 75265
Copyright © 2013, Texas Instruments Incorporated

IMPORTANT NOTICE

Texas Instruments Incorporated and its subsidiaries (TI) reserve the right to make corrections, enhancements, improvements and other changes to its semiconductor products and services per JESD46, latest issue, and to discontinue any product or service per JESD48, latest issue. Buyers should obtain the latest relevant information before placing orders and should verify that such information is current and complete. All semiconductor products (also referred to herein as "components") are sold subject to TI's terms and conditions of sale supplied at the time of order acknowledgment.

TI warrants performance of its components to the specifications applicable at the time of sale, in accordance with the warranty in TI's terms and conditions of sale of semiconductor products. Testing and other quality control techniques are used to the extent TI deems necessary to support this warranty. Except where mandated by applicable law, testing of all parameters of each component is not necessarily performed.

TI assumes no liability for applications assistance or the design of Buyers' products. Buyers are responsible for their products and applications using TI components. To minimize the risks associated with Buyers' products and applications, Buyers should provide adequate design and operating safeguards.

TI does not warrant or represent that any license, either express or implied, is granted under any patent right, copyright, mask work right, or other intellectual property right relating to any combination, machine, or process in which TI components or services are used. Information published by TI regarding third-party products or services does not constitute a license to use such products or services or a warranty or endorsement thereof. Use of such information may require a license from a third party under the patents or other intellectual property of the third party, or a license from TI under the patents or other intellectual property of TI.

Reproduction of significant portions of TI information in TI data books or data sheets is permissible only if reproduction is without alteration and is accompanied by all associated warranties, conditions, limitations, and notices. TI is not responsible or liable for such altered documentation. Information of third parties may be subject to additional restrictions.

Resale of TI components or services with statements different from or beyond the parameters stated by TI for that component or service voids all express and any implied warranties for the associated TI component or service and is an unfair and deceptive business practice. TI is not responsible or liable for any such statements.

Buyer acknowledges and agrees that it is solely responsible for compliance with all legal, regulatory and safety-related requirements concerning its products, and any use of TI components in its applications, notwithstanding any applications-related information or support that may be provided by TI. Buyer represents and agrees that it has all the necessary expertise to create and implement safeguards which anticipate dangerous consequences of failures, monitor failures and their consequences, lessen the likelihood of failures that might cause harm and take appropriate remedial actions. Buyer will fully indemnify TI and its representatives against any damages arising out of the use of any TI components in safety-critical applications.

In some cases, TI components may be promoted specifically to facilitate safety-related applications. With such components, TI's goal is to help enable customers to design and create their own end-product solutions that meet applicable functional safety standards and requirements. Nonetheless, such components are subject to these terms.

No TI components are authorized for use in FDA Class III (or similar life-critical medical equipment) unless authorized officers of the parties have executed a special agreement specifically governing such use.

Only those TI components which TI has specifically designated as military grade or "enhanced plastic" are designed and intended for use in military/aerospace applications or environments. Buyer acknowledges and agrees that any military or aerospace use of TI components which have **not** been so designated is solely at the Buyer's risk, and that Buyer is solely responsible for compliance with all legal and regulatory requirements in connection with such use.

TI has specifically designated certain components as meeting ISO/TS16949 requirements, mainly for automotive use. In any case of use of non-designated products, TI will not be responsible for any failure to meet ISO/TS16949.

Products

Audio	www.ti.com/audio
Amplifiers	amplifier.ti.com
Data Converters	dataconverter.ti.com
DLP® Products	www.dlp.com
DSP	dsp.ti.com
Clocks and Timers	www.ti.com/clocks
Interface	interface.ti.com
Logic	logic.ti.com
Power Mgmt	power.ti.com
Microcontrollers	microcontroller.ti.com
RFID	www.ti-rfid.com
OMAP Applications Processors	www.ti.com/omap
Wireless Connectivity	www.ti.com/wirelessconnectivity

Applications

Automotive and Transportation	www.ti.com/automotive
Communications and Telecom	www.ti.com/communications
Computers and Peripherals	www.ti.com/computers
Consumer Electronics	www.ti.com/consumer-apps
Energy and Lighting	www.ti.com/energy
Industrial	www.ti.com/industrial
Medical	www.ti.com/medical
Security	www.ti.com/security
Space, Avionics and Defense	www.ti.com/space-avionics-defense
Video and Imaging	www.ti.com/video

TI E2E Community

e2e.ti.com

Looking for pricing, stock, or lifecycle information?

Click below to explore more details on WIN SOURCE:

 [View TPS92411EVM-001 on WIN SOURCE](#)

 [Texas Instruments](#) Information

Optimize Your Supply Chain with WIN SOURCE Solutions

-  Global Sourcing Solution
-  Obsolete Management
-  Cost Control Management
-  Shortage Management
-  Alternative Solution
-  Excess Inventory Management