



**THE DATASHEET OF
ZB4BK1213**



Product data sheet

Specifications



Push button, Harmony 9001SK,
plastic, flush, green, 30mm, spring
return, 1 C/O

9001SKR1GH13

Main

Range of product	Harmony 9001SK
Product or component type	Push-button
Device short name	9001SK
Type of operator	spring return
Operator profile	Green flush, unmarked
Operator additional information	Plastic guard

Complementary

Bezel material	Plastic
Mounting diameter	30 mm
Shape of signaling unit head	Octagonal
Contacts type and composition	1 C/O
Contact operation	Standard
Connections - terminals	Screw clamp terminals 1 x 0.22...2 x 1.5 mm ² conforming to IEC 60947-1
Tightening torque	0.8 N.m conforming to IEC 60947-1
Shape of screw head	Cross slotted
Mechanical durability	5000000 cycles
Operating position	Any position
[Ie] rated operational current	3 A at 240 V, AC-15, A600-Q600 0.55 A at 125 V, DC-13, A600-Q600
[Ui] rated insulation voltage	250 V (pollution degree 3) conforming to IEC 60947-1
[Uimp] rated impulse withstand voltage	2.5 kV conforming to IEC 60947-1
Contacts material	Silver alloy contacts
Positive opening	Without
Short-circuit protection	10 A cartridge fuse conforming to IEC 60947-5-1
[Ith] conventional free air thermal current	10 A
[Icm] rated short-circuit making capacity	12 kA at 600 V AC-15, 7200 VA 15 kA at 480 V AC-15, 7200 VA 30 kA at 240 V AC-15, 7200 VA 60 kA at 120 V AC-15, 7200 VA 0.1 kA at 600 V DC-13 0.27 kA at 250 V DC-13 0.55 kA at 125 V DC-13

Rated breaking capacity	3 kA at 240 V AC-15, 720 VA 6 kA at 120 V AC-15, 720 VA 1.2 kA at 600 V AC-15, 720 VA 1.5 kA at 480 V AC-15, 720 VA 0.1 kA at 600 V DC-13 0.27 kA at 250 V DC-13 0.55 kA at 125 V DC-13
Product weight	0.086 kg
Device presentation	Complete product
Cap/operator or lens colour	Green
Operator profile	Flush
Type of operator	Spring return
Size	30 mm

Environment

Standards	IEC 60947-1 IEC 60947-5-4 JIS C 852 IEC 60947-5-1 CSA C22.2 No 14 JIS C 4520
Product certifications	NEMA UL 508
Protective treatment	TC
Ambient air temperature for storage	-40...70 °C
Ambient air temperature for operation	-25...70 °C
Vibration resistance	7 gn (f= 2...500 Hz) conforming to IEC 60068-2-6
Shock resistance	50 gn conforming to IEC 60068-2-27
Electrical shock protection class	Class II conforming to IEC 61140
IP degree of protection	IP66 conforming to IEC 60529
NEMA degree of protection	NEMA 1 NEMA 12 NEMA 13 NEMA 2 NEMA 3 NEMA 3R NEMA 4 NEMA 4X

Packing Units

Unit Type of Package 1	PCE
Number of Units in Package 1	1
Package 1 Height	5.1 cm
Package 1 Width	5.8 cm
Package 1 Length	9.4 cm
Package 1 Weight	91.0 g

Contractual warranty

Warranty	18 months
-----------------	-----------

Environmental Data

Schneider Electric aims to achieve Net Zero status by 2050 through supply chain partnerships, lower impact materials, and circularity via our ongoing “Use Better, Use Longer, Use Again” campaign to extend product lifetimes and recyclability.



[Environmental Data explained >](#)

[How we assess product sustainability >](#)

Use Better

 Materials and Substances	
Packaging made with recycled cardboard	Yes
Packaging without single use plastic	Yes
EU RoHS Directive	Pro-active compliance (Product out of EU RoHS legal scope)
California proposition 65	WARNING: This product can expose you to chemicals including: Lead and lead compounds, which is known to the State of California to cause cancer and birth defects or other reproductive harm. For more information go to www.P65Warnings.ca.gov

Use Again

 Repack and remanufacture	
Take-back	No
WEEE Label	 The product must be disposed on European Union markets following specific waste collection and never end up in rubbish bins

Dimensions Drawings

Dimensions

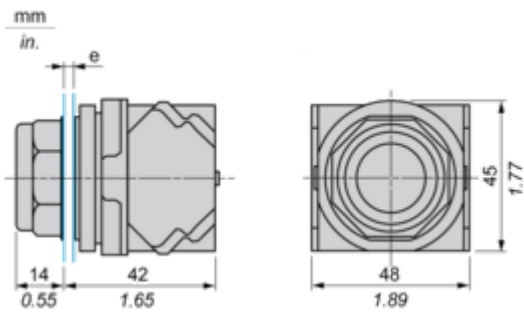

e panel thickness: 1 to 6 mm / 0.04 to 0.24 in.

Mounting and Clearance

Contact Block Mounting Position

Top and Rear views

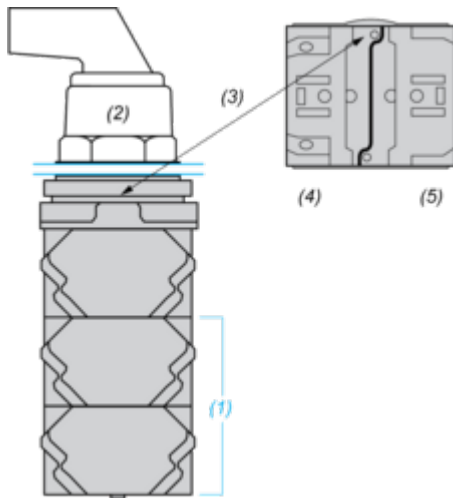

- (1) It is possible to mount up to 3 levels of contacts blocks (maximum of 6 contacts blocks)
- (2) Operator
- (3) Locating notch
- (4) Side 1
- (5) Side 2

Looking for pricing, stock, or lifecycle information?

Click below to explore more details on WIN SOURCE:

 [View ZB4BK1213 on WIN SOURCE](#)

 [Schneider Electric](#) Information

Optimize Your Supply Chain with WIN SOURCE Solutions

-  Global Sourcing Solution
-  Obsolete Management
-  Cost Control Management
-  Shortage Management
-  Alternative Solution
-  Excess Inventory Management