



THE DATASHEET OF
704.413.0



Actuator

704.504.0

Distribution by
DigiKey

DigiKey

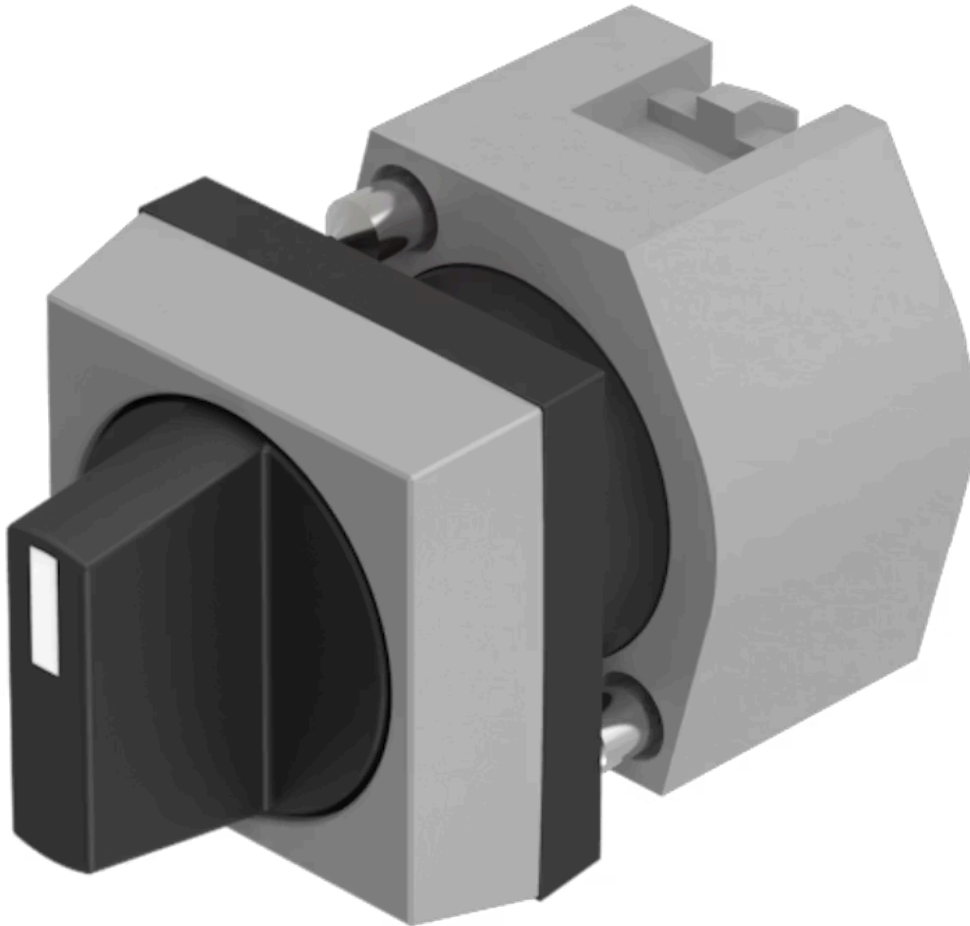

<https://digkey.eao.com/component/704.504.0/e...>

Your product:



704.504.0 Actuator

Loading ...

FRONT

Front dimension:	30 mm x 30 mm
Front form:	Square
Front bezel colour:	Grey
Front bezel material:	Plastic

MOUNTING

Design:	Raised
Mounting cut-out:	Ø 22.5 mm
Mounting type:	Panel mounting

OPERATING-/INDICATION PART

Lever colour:	Black
Lever bar colour:	White
Lever material:	plastic
Lever shape:	short

ELECTRICAL CHARACTERISTICS

Standards:	The switches comply with the "Standards for low-voltage switching devices" DIN EN 60947-1
-------------------	---

MECHANICAL CHARACTERISTICS

Switching action:	Momentary - Rest - Momentary
Switching positions:	3 positions

Switching angle: 42° left / 42° right
Mechanical lifetime: ≤2.5 Mil. cycles of operation
Weight: 0.027 kg

AMBIENT CONDITION

IP Protection: IP65 front side
Operating temperature: - 40 °C ... + 55 °C
Storage temperature: - 40 °C ... + 85 °C

CERTIFICATE

REACH: REACH compliant
RoHS: RoHS compliant

OTHER

Short Description: Actuator, Ø 22.5 mm, 30 mm x 30 mm, non illuminative, Black, short, Square, Grey, Plastic, Momentary - Rest - Momentary

Hints: Max. 3 switching elements can be clipped on

max. number of switching elements: 3

Switching positions:

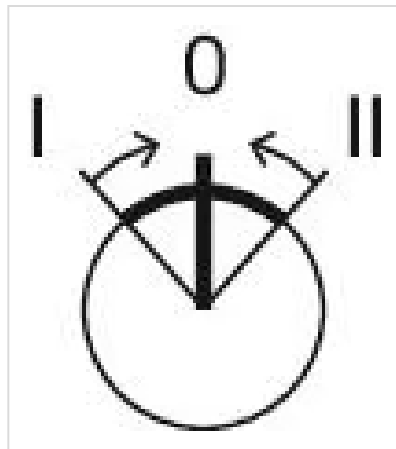

Wiring diagrams:



Mounting cut-outs:

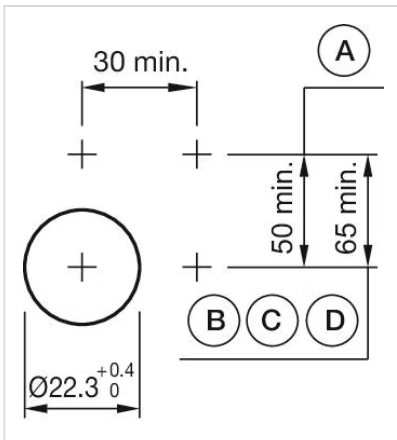

- A = Screw terminal
- B = Push-in terminal (PIT)
- C = Plug-in terminal 6.3 mm x 0.8 mm
- D = Double plug-in terminal 6.3 mm x 0.8 mm

Dimension drawings:

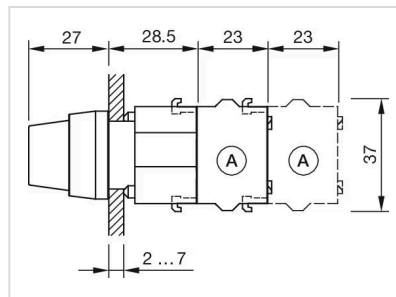

A = Screw terminal

Looking for pricing, stock, or lifecycle information?

Click below to explore more details on WIN SOURCE:

 [View 704.413.0 on WIN SOURCE](#)

 [EAO Information](#)

Optimize Your Supply Chain with WIN SOURCE Solutions

-  Global Sourcing Solution
-  Obsolete Management
-  Cost Control Management
-  Shortage Management
-  Alternative Solution
-  Excess Inventory Management