



**THE DATASHEET OF
RB901-VB-B-1-V**



Actuator

61-4110.0

Distribution by
DigiKey

DigiKey



<https://digikey.eao.com/component/61-4110.0/e...>

Your product:



61-4110.0 Actuator

Loading ...

MOUNTING

Mounting type: Panel mounting

OPERATING-/INDICATION PART

Lever material: plastic

Lever shape: short

MECHANICAL CHARACTERISTICS

Switching action: Rest - Momentary

Switching positions: 2 positions

Switching angle: 42° right

Mechanical lifetime: According to DIN/IEC 60512-5-6 and EN/IEC 60947-5-1, 100 000 cycles of operation

Operating force: 0.025...0.1 Nm snap-action switching element, 0.4 ... 0.16 Nm slow-make switching element

Operating Travel: ca. 42°

Tightening torque: Max. 0.5 Nm

Weight: 0.005 kg

AMBIENT CONDITION

IP Protection: IP40 rear side, according to EN IEC 60529, IP67 front side, according to EN IEC 60529

Operating temperature: – 25 °C ... + 55 °C

Storage temperature: – 40 °C ... + 85 °C

CERTIFICATE

REACH: REACH compliant

RoHS: RoHS compliant

OTHER

Short Description: Actuator, optional illuminative, short, Rest - Momentary

Housing material: Plastic, according to UL 94 V0, self-extinguishing

Product attributes: Illuminative

Switching positions:

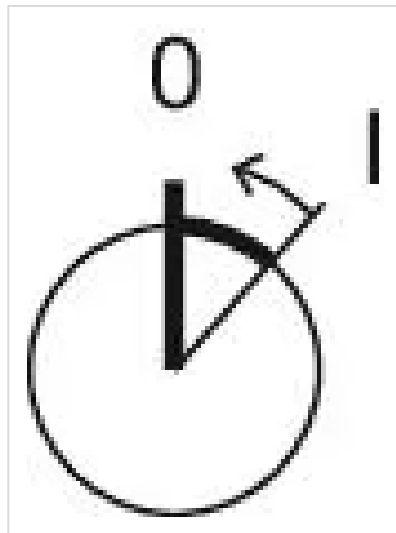

Wiring diagrams:



Mounting cut-outs:

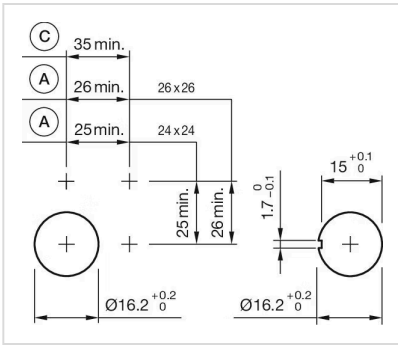

A = Solder/Plug-in terminal 2.8 mm x 0.5 mm
 C = Screw terminal

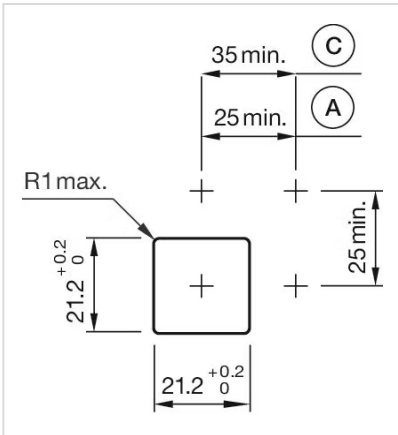

A = Solder/Plug-in terminal 2.8 mm x 0.5 mm
 C = Screw terminal

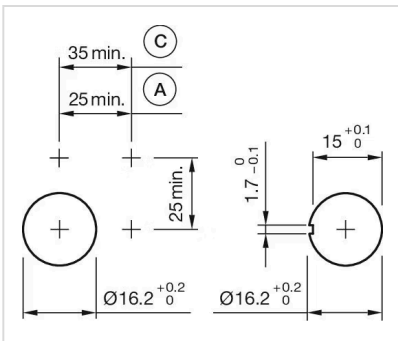

A = Solder/Plug-in terminal 2.8 mm x 0.5 mm
 C = Screw terminal

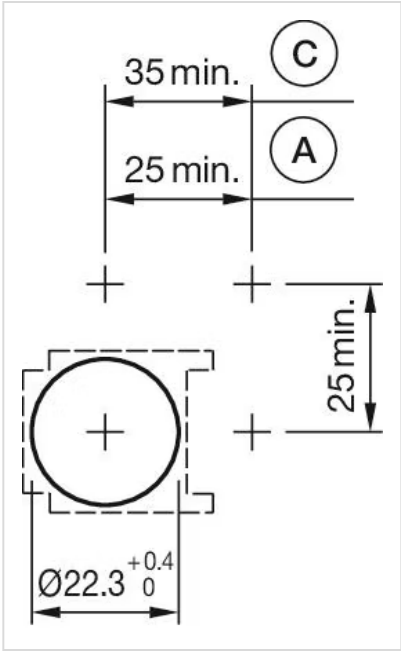

A = Solder/Plug-in terminal 2.8 mm x 0.5 mm
C = Screw terminal

Dimension drawings:

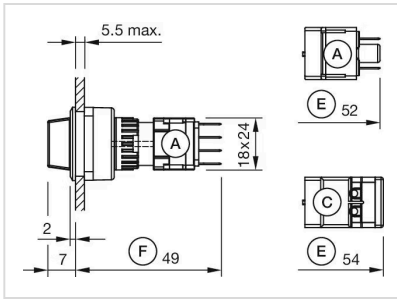

A = Plug-in terminal 2.8 mm x 0.5 mm
 C = Screw terminal
 E = Slow-make switching element
 F = Snap-action switching element

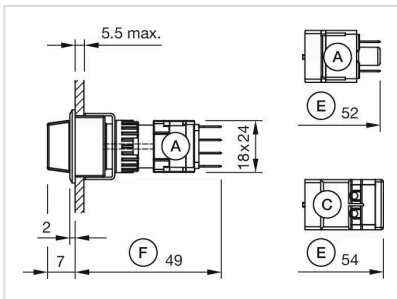

A = Plug-in terminal 2.8 mm x 0.5 mm
 C = Screw terminal
 E = Slow-make switching element
 F = Snap-action switching element

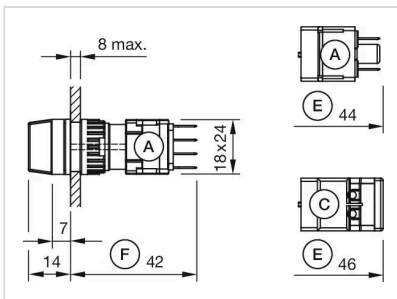

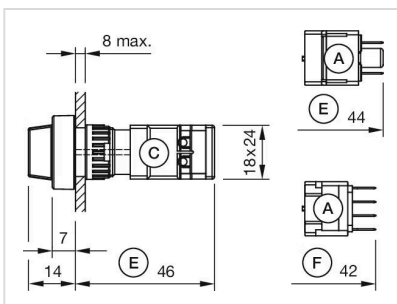

A = Plug-in terminal 2.8 mm x 0.5 mm
 C = Screw terminal
 E = Slow-make switching element
 F = Snap-action switching element



A = Plug-in terminal 2.8 mm x 0.5 mm
 C = Screw terminal
 E = Slow-make switching element
 F = Snap-action switching element

Looking for pricing, stock, or lifecycle information?

Click below to explore more details on WIN SOURCE:

-  [View RB901-VB-B-1-V on WIN SOURCE](#)
-  [Carling Technologies Information](#)

Optimize Your Supply Chain with WIN SOURCE Solutions

-  Global Sourcing Solution
-  Obsolete Management
-  Cost Control Management
-  Shortage Management
-  Alternative Solution
-  Excess Inventory Management