



**THE DATASHEET OF
9001KR3UH5**





Main

Range of Product	Harmony 9001B
Product or Component Type	Complete control station
Device short name	9001BG

Complementary

Control station composition	2 push-buttons
Contacts type and composition	2 NO + 2 NC
Connections - terminals	Screw clamp terminal
[Ie] rated operational current	5 A 600 V
Device mounting	Surface
Type of Installation	Indoor

Environment

NEMA degree of protection	NEMA 1
Product Certifications	CE UL listed file E42259 CCN NKCR CSA LR25490 class 3211 03
Environmental characteristic	Standard environment

Ordering and shipping details

Category	21421 - 9001 B (NOT BW70 - BW80)
Discount Schedule	CS1
GTIN	785901390251
Nbr. of units in pkg.	1
Package weight(Lbs)	10.08 oz (285.763 g)
Returnability	No
Country of origin	MX

Packing Units

Unit Type of Package 1	PCE
Package 1 Height	10.16 in (25.806 cm)
Package 1 width	4.00 in (10.16 cm)
Package 1 Length	25.81 in (65.548 cm)

Offer Sustainability

Sustainable offer status	Green Premium product
California proposition 65	WARNING: This product can expose you to chemicals including: Nickel compounds, which is known to the State of California to cause cancer, and Di-isodecyl phthalate (DIDP), which is known to the State of California to cause birth defects or other reproductive harm. For more information go to www.P65Warnings.ca.gov
REACH Regulation	REACH Declaration
REACH free of SVHC	Yes
EU RoHS Directive	Pro-active compliance (Product out of EU RoHS legal scope) EU RoHS Declaration
Toxic heavy metal free	Yes
Mercury free	Yes
RoHS exemption information	Yes
China RoHS Regulation	China RoHS Declaration
Environmental Disclosure	Product Environmental Profile
Circularity Profile	End Of Life Information

Contractual warranty

Warranty	18 months
----------	-----------

Approximate Dimensions

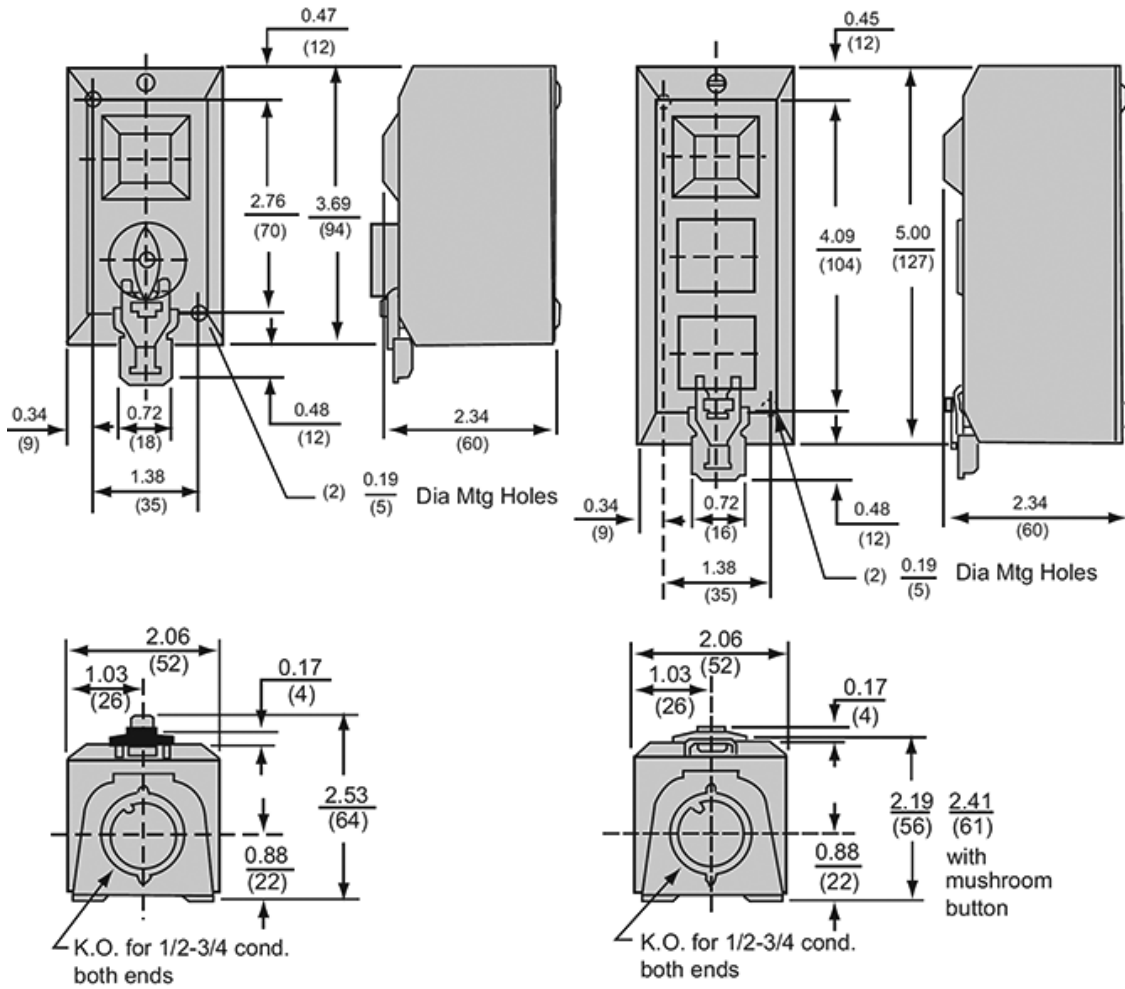

Looking for pricing, stock, or lifecycle information?

Click below to explore more details on WIN SOURCE:

 [View 9001KR3UH5 on WIN SOURCE](#)

 [Schneider Electric](#) Information

Optimize Your Supply Chain with WIN SOURCE Solutions

-  Global Sourcing Solution
-  Obsolete Management
-  Cost Control Management
-  Shortage Management
-  Alternative Solution
-  Excess Inventory Management