

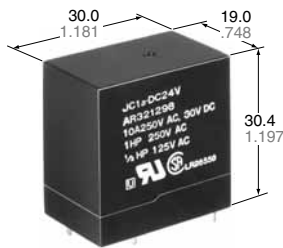

**THE DATASHEET OF  
JC1AF-TM-DC6V**





PC board type

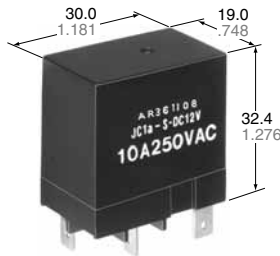

Plug-in type

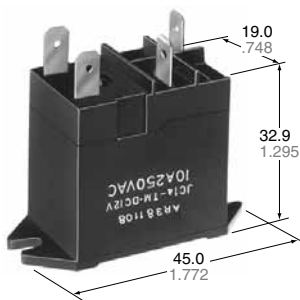

TM type

mm inch

RoHS Directive compatibility information  
<http://www.nais-e.com/>

## FEATURES

- **High inrush current capability**  
 1 Form A: 163 A inrush (TV-8)  
 2 Form A: 111 A inrush (TV-5)
- **High dielectric withstanding for transient protection:**  
 JC can withstand 10,000 V surge in  $\mu$ s between coil and contact.
- **Electrical life:**  
 1 Form A:  $10^5$  ope. at 15 A 250 V AC resistive load  
 2 Form A:  $10^5$  ope. at 10 A 250 V AC resistive load
- **UL/CSA, VDE, TÜV, SEMKO also approved.**

## COMMENTS ABOUT Cd FREE

We have introduced Cadmium free type products to reduce the material which is not good for our environment. (The suffix "F" should be added to the part number.) If you are still using Cadmium containing parts, which don't have "F" on the suffix of the part number, please use Cadmium free parts from now on. The life of the Cadmium free parts may be shorter than the Cadmium containing parts based on the load condition, so please evaluate the Cadmium free parts with your actual application before use.

## SPECIFICATIONS

### Contact

Arrangement		1 Form A	2 Form A
Initial contact resistance, max. (By voltage drop 6 V DC 1 A)		30 m $\Omega$	
Contact material		AgSnO <sub>2</sub> type	
Contact force, min.		30 g	
Rating (resistive load)	Maximum switching power	3,750 VA	2,500 VA
	Maximum switching voltage	250 V AC	250 V AC
	Max. switching current	15 A	10 A
	Min. switching capacity <sup>#1</sup>	100 mA, 5 V DC	
Expected life (min. operation)	Mechanical	$5 \times 10^6$	
	Electrical (resistive)	10 A 250 V AC	$10^5$
		5A 250 V AC	—

### Coil

Nominal operating power	900 mW	1,000 mW
-------------------------	--------	----------

<sup>#1</sup> This value can change due to the switching frequency, environmental conditions, and desired reliability level, therefore it is recommended to check this with the actual load.

### Remarks

- \* Specifications will vary with foreign standards certification ratings.
- <sup>#1</sup> Measurement of same location as "Initial breakdown voltage" section
- <sup>#2</sup> Detection current: 10mA
- <sup>#3</sup> Excluding contact bounce time
- <sup>#4</sup> Half-wave pulse of sine wave: 11ms; detection time: 10 $\mu$ s
- <sup>#5</sup> Half-wave pulse of sine wave: 6ms
- <sup>#6</sup> Detection time: 10 $\mu$ s
- <sup>#7</sup> Refer to 6. Conditions for operation, transport and storage mentioned in AMBIENT ENVIRONMENT

### Characteristics

Maximum operating speed	20 cpm.	
Initial insulation resistance <sup>*1</sup>	Min. 100 M $\Omega$ at 500 V DC	
Initial breakdown voltage <sup>*2</sup>	Between open contacts	2,000 V rms for 1 min.
	Between contacts sets	2,000 Vrms for 1 min.
	Between contacts and coil	4,000 Vrms for 1 min.
Operate time <sup>*3</sup> (at nominal voltage)	Max. 30 ms	
Release time(without diode) <sup>*3</sup> (at nominal voltage)	Max. 10 ms	
Temperature rise (at nominal voltage)	Max. 55°C	
Shock resistance	Functional <sup>*4</sup>	196 m/s <sup>2</sup> {20 G}
	Destructive <sup>*5</sup>	980 m/s <sup>2</sup> {100 G}
Vibration resistance	Functional <sup>*6</sup>	98 m/s <sup>2</sup> {10 G}, 10 to 55 Hz at double amplitude of 1.6 mm
	Destructive	117.6 m/s <sup>2</sup> {12 G}, 10 to 55 Hz at double amplitude of 2 mm
Conditions for operation, transport and storage <sup>*7</sup> (Not freezing and condensing at low temperature)	Ambient temp.	-50°C to +60°C -58°F to +140°F
	Humidity	5 to 85%R.H.
Unit weight	Approx. 31 g 1.09 oz	



Top mount type

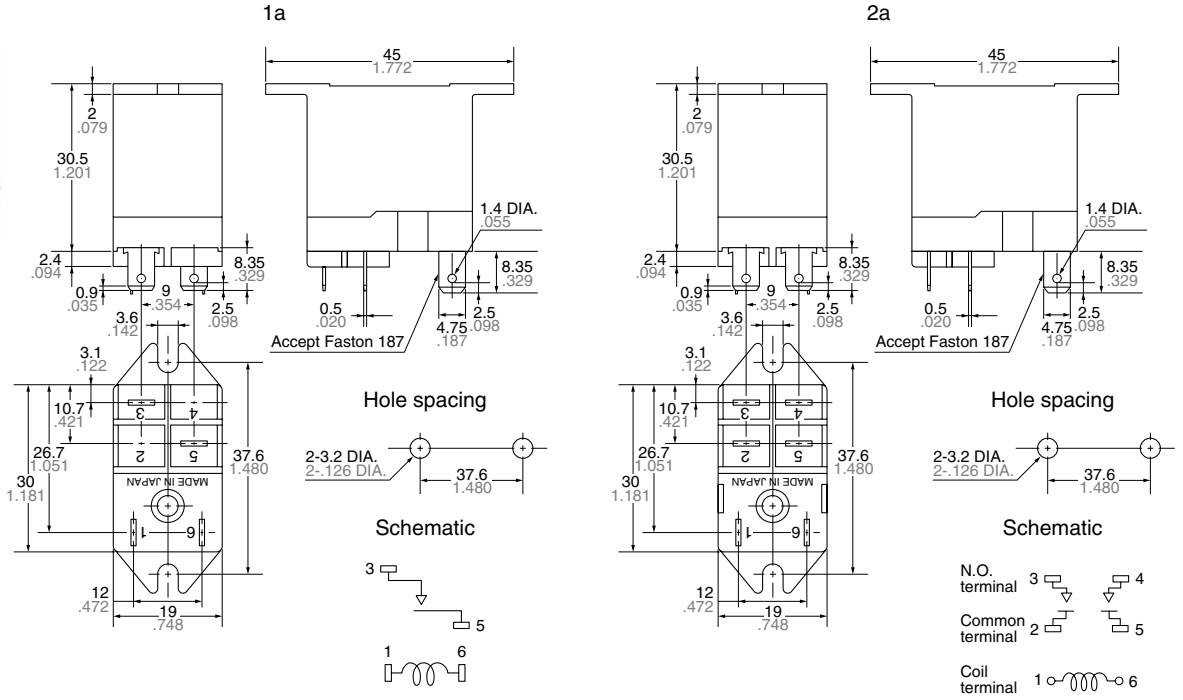

Plug-in type

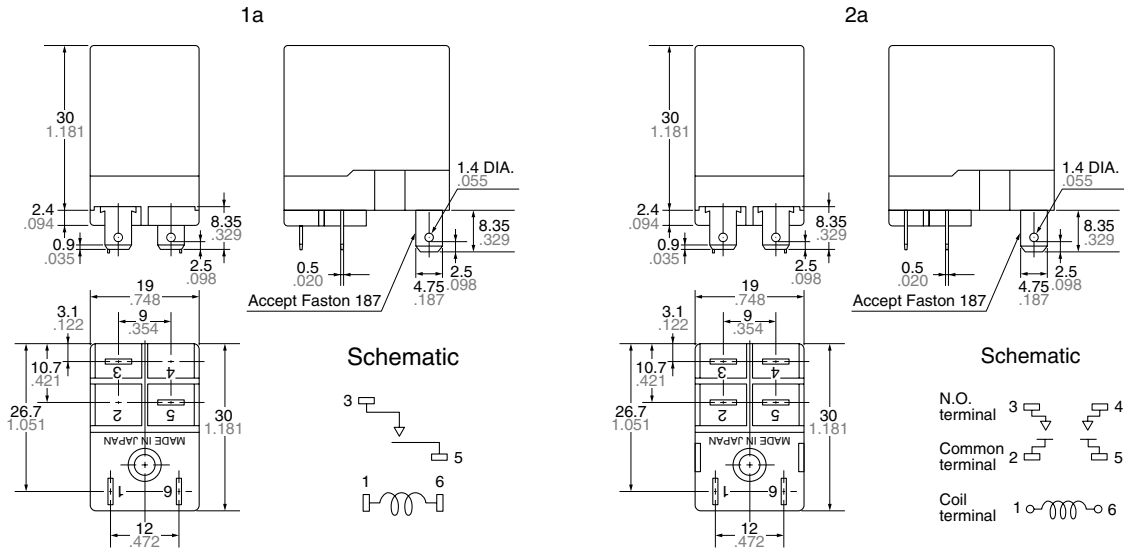

General tolerance:  $\pm 0.3 \pm .012$

REFERENCE DATA

JC1a type

1. Maximum value for switching capacity

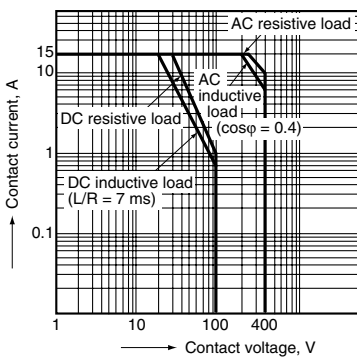

2. Life curve

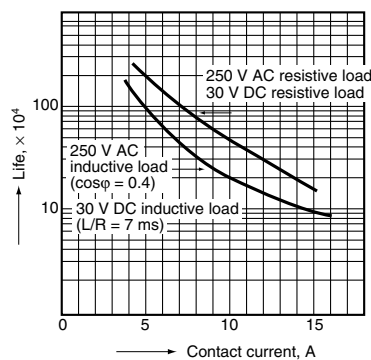

3.-(1) Coil temperature rise

Point measured: Inside the coil  
Ambient temperature: 26°C 79°F

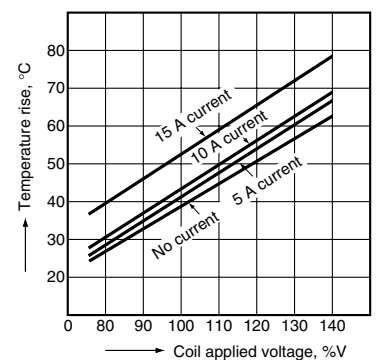

3.-(2) Coil temperature rise

Point measured: Inside the coil  
Ambient temperature: 40°C 104°F

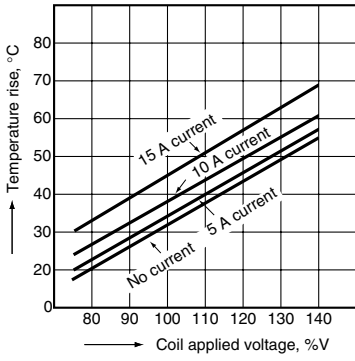

3.-(3) Coil temperature rise

Point measured: Inside the coil  
Ambient temperature: 60°C 140°F

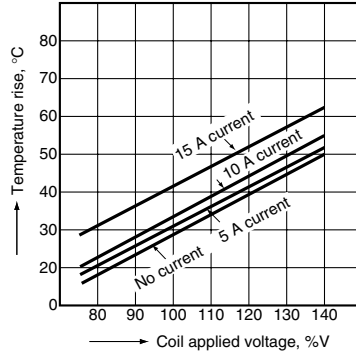

4. Operate / release time

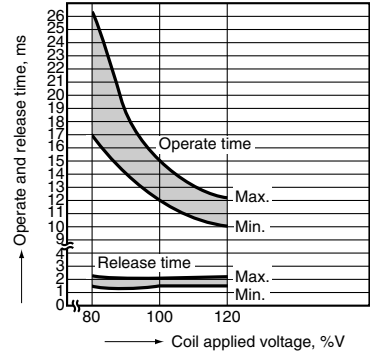

JC2a type

1. Maximum value for switching capacity

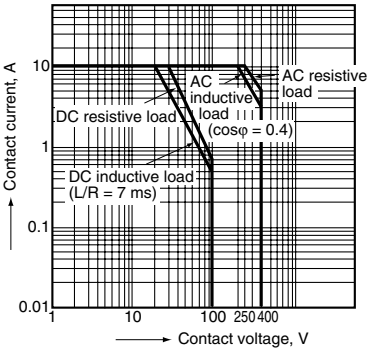

2. Life curve

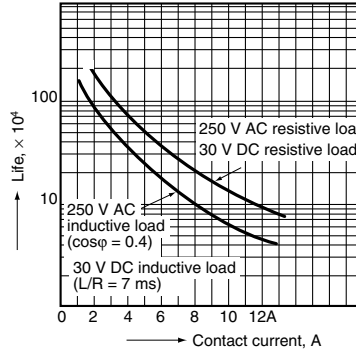

3.-(1) Coil temperature rise

Point measured: Inside the coil  
Ambient temperature: 26°C 79°F

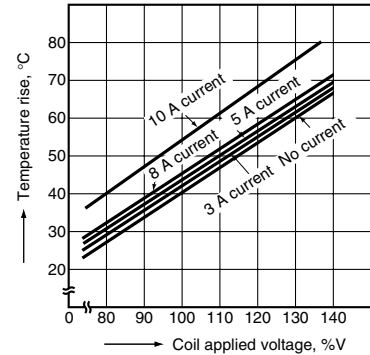

3.-(2) Coil temperature rise

Point measured: Inside the coil  
Ambient temperature: 40°C 104°F

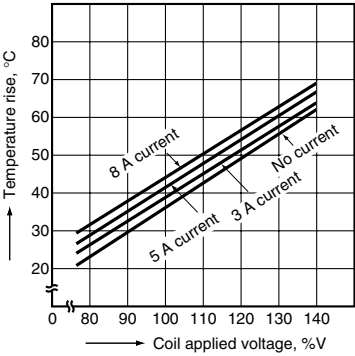

3.-(3) Coil temperature rise

Point measured: Inside the coil  
Ambient temperature: 60°C 140°F

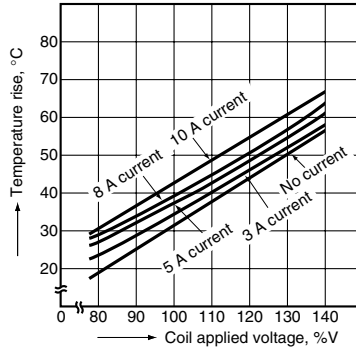

4. Operate / release time

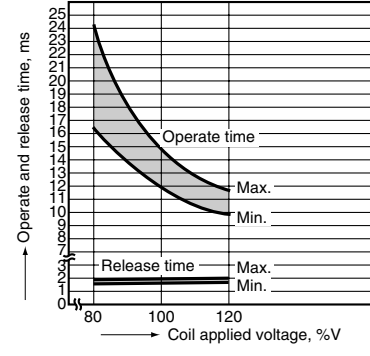

**ACCESSORIES**



JC1-SS



JC2-SS



JC1-PS



JC2-PS

JC2-SS

JC2-PS

mm inch

Tolerance:  $\pm 0.5 \pm .020$

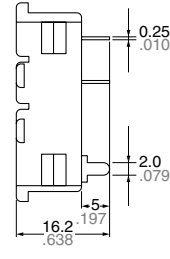
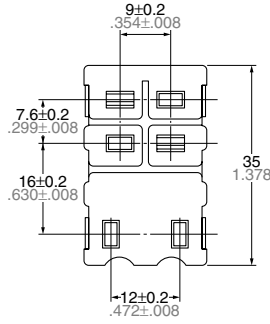
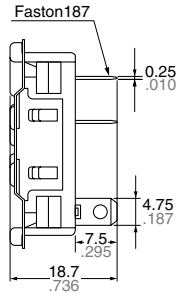
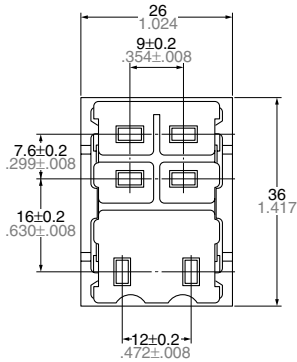

JC1-PS

JC2-PS

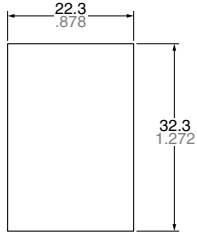
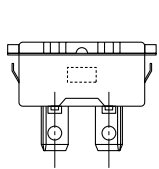

Panel cutout  
Tolerance:  $\pm 0.1 \pm .004$

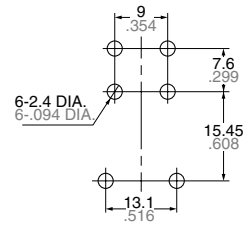
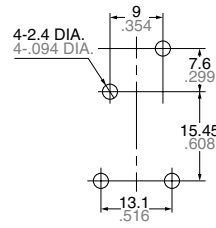
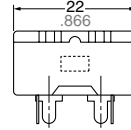

PC board Pattern  
Tolerance:  $\pm 0.1 \pm .004$

(Note)

Outward dimensions and chassis cutout dimensions for JC1-SS and JC1-PS are same as those of JC2-SS and JC2-PS respectively.  
UL/CSA approved type is standard.

**For Cautions for Use, see Relay Technical Information**

## Looking for pricing, stock, or lifecycle information?

Click below to explore more details on WIN SOURCE:

- [View JC1AF-TM-DC6V on WIN SOURCE](#)
- [Panasonic Information](#)

## Optimize Your Supply Chain with WIN SOURCE Solutions

- ✓ Global Sourcing Solution
- ✓ Obsolete Management
- ✓ Cost Control Management
- ✓ Shortage Management
- ✓ Alternative Solution
- ✓ Excess Inventory Management