

High Voltage IGBT

IXGT6N170 IXGH6N170

$V_{CES} = 1700V$
 $I_{C90} = 6A$
 $V_{CE(sat)} \leq 4.0V$
 $t_{fi(typ)} = 290ns$

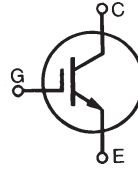

Symbol	Test Conditions	Maximum Ratings	
V_{CES}	$T_C = 25^\circ C$ to $150^\circ C$	1700	V
V_{CGR}	$T_J = 25^\circ C$ to $150^\circ C$, $R_{GE} = 1M\Omega$	1700	V
V_{GES}	Continuous	± 20	V
V_{GEM}	Transient	± 30	V
I_{C25}	$T_C = 25^\circ C$	12	A
I_{C90}	$T_C = 90^\circ C$	6	A
I_{CM}	$T_C = 25^\circ C$, 1ms	24	A
SSOA	$V_{GE} = 15V$, $T_{VJ} = 125^\circ C$, $R_G = 33\Omega$	$I_{CM} = 12$	A
(RBSOA)	Clamped Inductive Load	@ $0.8 \cdot V_{CES}$	
P_C	$T_C = 25^\circ C$	75	W
T_J		- 55 ... +150	$^\circ C$
T_{JM}		150	$^\circ C$
T_{stg}		- 55 ... +150	$^\circ C$
T_L	Maximum Lead Temperature for Soldering	300	$^\circ C$
T_{SOLD}	1.6 mm (0.062in.) from Case for 10s	260	$^\circ C$
M_d	Mounting Torque (TO-247)	1.13/10	Nm/lb.in.
Weight	TO-268	4	g
	TO-247	6	g

TO-268 (IXGT)

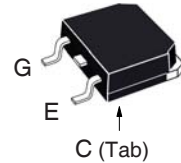

TO-247 (IXGH)

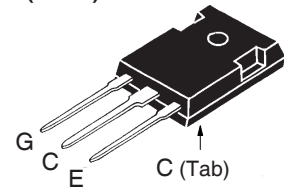

G = Gate C = Collector
 E = Emitter Tab = Collector

Features

- International Standard Packages
- High Voltage Package

Advantages

- High Power Density
- Low Gate Drive Requirement

Applications

- Capacitor Discharge & Pulse Circuits
- Uninterruptible Power Supplies (UPS)
- Motor Drives
- DC Servo & Robot Drives
- DC Choppers
- Switched-Mode & Resonant-Mode Power Supplies

Symbol	Test Conditions ($T_J = 25^\circ C$ Unless Otherwise Specified)	Characteristic Values		
		Min.	Typ.	Max.
BV_{CES}	$I_C = 250\mu A$, $V_{GE} = 0V$	1700		V
$V_{GE(th)}$	$I_C = 250\mu A$, $V_{CE} = V_{GE}$	3.0		V
I_{CES}	$V_{CE} = 0.8 \cdot V_{CES}$, $V_{GE} = 0V$ $T_J = 125^\circ C$			10 μA 100 μA
I_{GES}	$V_{CE} = 0V$, $V_{GE} = \pm 20V$			± 100 nA
$V_{CE(sat)}$	$I_C = I_{C90}$, $V_{GE} = 15V$, Note 1 $T_J = 125^\circ C$		3.0 4.0	4.0 V

Symbol	Test Conditions ($T_J = 25^\circ\text{C}$, Unless Otherwise Specified)	Characteristic Values			
		Min.	Typ.	Max.	
g_{fs}	$I_C = 6\text{A}$, $V_{CE} = 10\text{V}$, Note 1	3.0	4.5	S	
$I_{C(ON)}$	$V_{GE} = 15\text{V}$, $V_{CE} = 10\text{V}$		28	A	
C_{ies}	$V_{CE} = 25\text{V}$, $V_{GE} = 0\text{V}$, $f = 1\text{MHz}$		330	pF	
C_{oes}			23	pF	
C_{res}			6	pF	
Q_g	$I_C = 6\text{A}$, $V_{GE} = 15\text{V}$, $V_{CE} = 0.5 \cdot V_{CES}$		20.0	nC	
Q_{ge}			3.6	nC	
Q_{gc}			8.0	nC	
$t_{d(on)}$	Inductive load, $T_J = 25^\circ\text{C}$ $I_C = 6\text{A}$, $V_{GE} = 15\text{V}$ $V_{CE} = 0.8 \cdot V_{CES}$, $R_G = 33\Omega$ Note 2		40	ns	
t_{ri}			36	ns	
$t_{d(off)}$			250	500	ns
t_{fi}			290	500	ns
E_{off}			1.5	2.5	mJ
$t_{d(on)}$	Inductive load, $T_J = 125^\circ\text{C}$ $I_C = 6\text{A}$, $V_{GE} = 15\text{V}$ $V_{CE} = 0.8 \cdot V_{CES}$, $R_G = 33\Omega$ Note 2		45	ns	
t_{ri}			40	ns	
E_{on}			0.5	mJ	
$t_{d(off)}$			300	ns	
t_{fi}			300	ns	
E_{off}		2.0	mJ		
R_{thJC}	TO-247			1.65 $^\circ\text{C/W}$	
R_{thCK}			0.21	$^\circ\text{C/W}$	

Notes:

1. Pulse test, $t \leq 300\mu\text{s}$, duty cycle, $d \leq 2\%$.
2. Switching times & energy losses may increase for higher V_{CE} (clamp), T_J or R_G .

TO-268 Outline

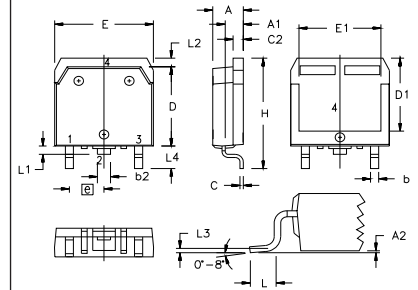

Terminals: 1 - Gate, 2,4 - Collector, 3 - Emitter

SYM	INCHES		MILLIMETERS	
	MIN	MAX	MIN	MAX
A	.193	.201	4.90	5.10
A1	.106	.114	2.70	2.90
A2	.001	.010	0.02	0.25
b	.045	.057	1.15	1.45
b2	.075	.083	1.90	2.10
C	.016	.026	0.40	0.65
C2	.057	.063	1.45	1.60
D	.543	.551	13.80	14.00
D1	.488	.500	12.40	12.70
E	.624	.632	15.85	16.05
E 1	.524	.535	13.30	13.60
e	.215 BSC		5.45 BSC	
H	.736	.752	18.70	19.10
L	.094	.106	2.40	2.70
L1	.047	.055	1.20	1.40
L2	.039	.045	1.00	1.15
L3	.010 BSC		0.25 BSC	
L4	.150	.161	3.80	4.10

TO-247 Outline

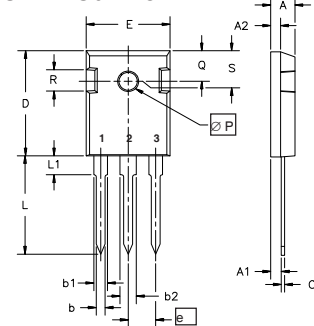

Terminals: 1 - Gate, 2 - Collector, 3 - Emitter

Dim.	Millimeter		Inches	
	Min.	Max.	Min.	Max.
A	4.7	5.3	.185	.209
A ₁	2.2	2.54	.087	.102
A ₂	2.2	2.6	.059	.098
b	1.0	1.4	.040	.055
b ₁	1.65	2.13	.065	.084
b ₂	2.87	3.12	.113	.123
C	.4	.8	.016	.031
D	20.80	21.46	.819	.845
E	15.75	16.26	.610	.640
e	5.20	5.72	0.205	0.225
L	19.81	20.32	.780	.800
L1		4.50		.177
∅P	3.55	3.65	.140	.144
Q	5.89	6.40	0.232	0.252
R	4.32	5.49	.170	.216
S		6.15 BSC		242 BSC

IXYS Reserves the Right to Change Limits, Test Conditions, and Dimensions.

IXYS MOSFETs and IGBTs are covered by one or more of the following U.S. patents:

4,835,592	4,931,844	5,049,961	5,237,481	6,162,665	6,404,065 B1	6,683,344	6,727,585	7,005,734 B2	7,157,338B2
4,860,072	5,017,508	5,063,307	5,381,025	6,259,123 B1	6,534,343	6,710,405 B2	6,759,692	7,063,975 B2	
4,881,106	5,034,796	5,187,117	5,486,715	6,306,728 B1	6,583,505	6,710,463	6,771,478 B2	7,071,537	

Fig. 1. Output Characteristics @ $T_J = 25^\circ\text{C}$

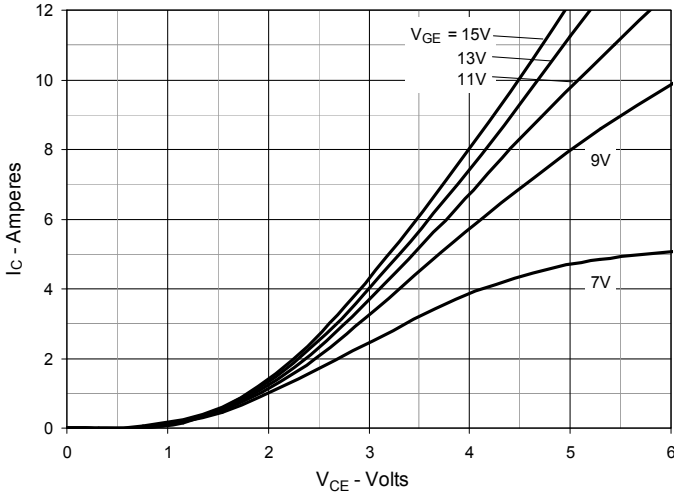

Fig. 2. Extended Output Characteristics @ $T_J = 25^\circ\text{C}$

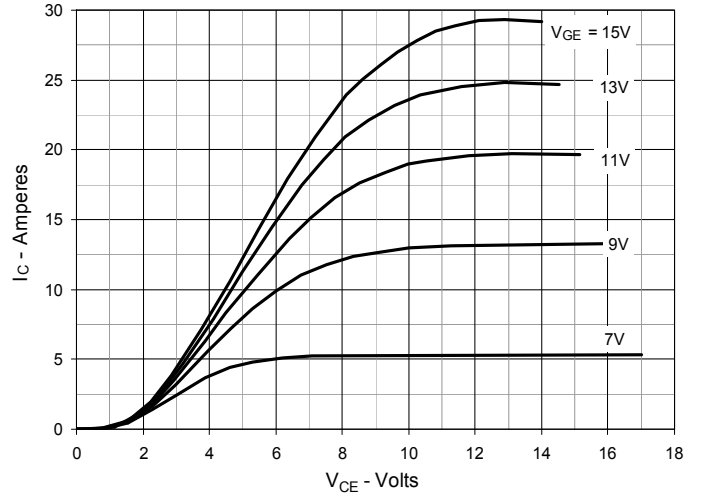

Fig. 3. Output Characteristics @ $T_J = 125^\circ\text{C}$

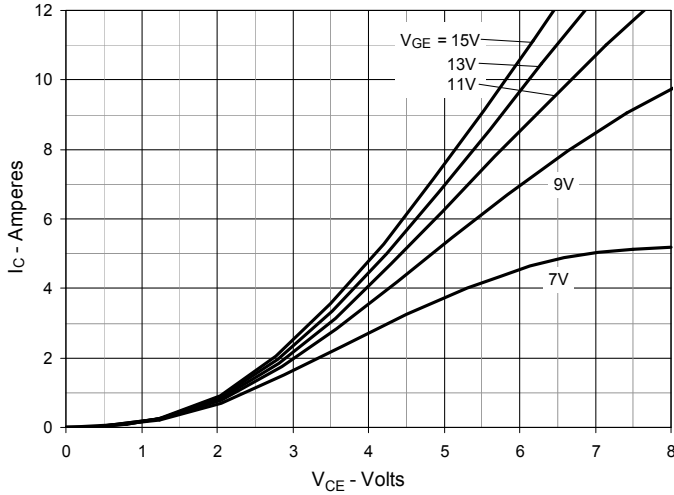

Fig. 4. Dependence of $V_{CE(sat)}$ on Junction Temperature

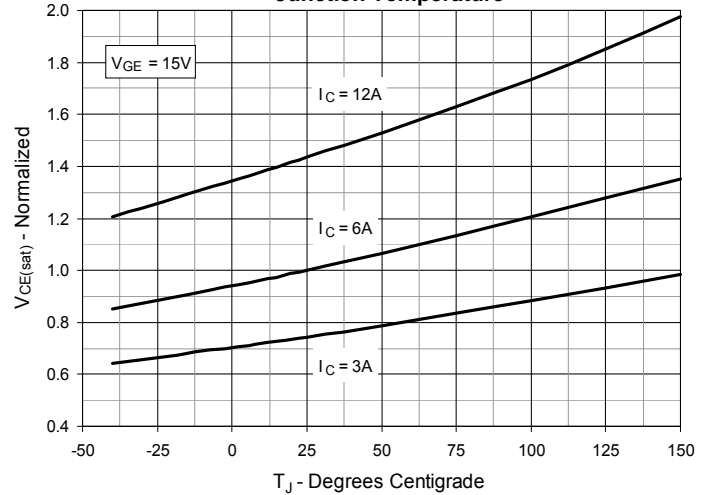

Fig. 5. Input Admittance

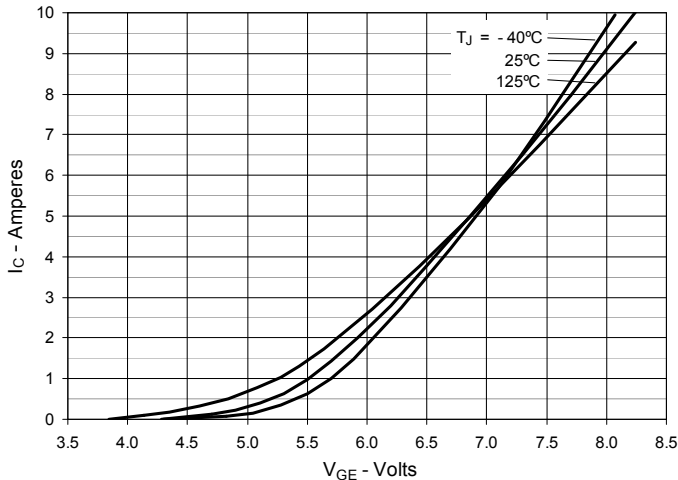

Fig. 6. Transconductance

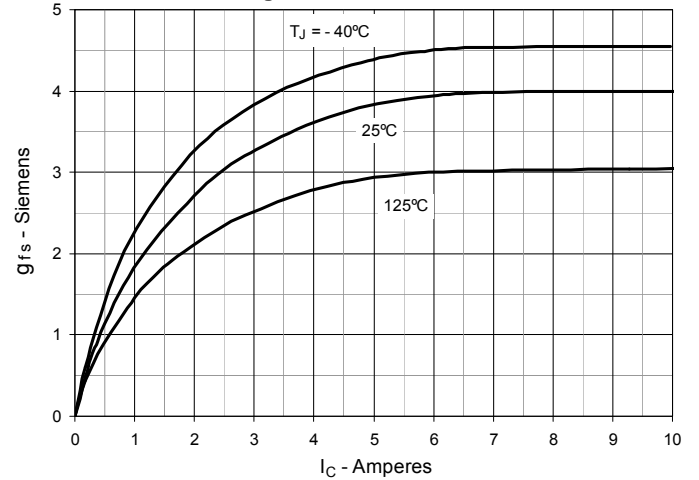

Fig. 7. Gate Charge

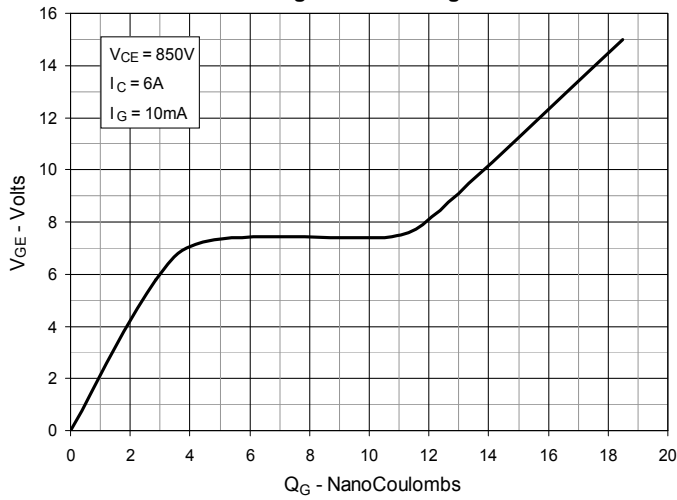

Fig. 8. Capacitance

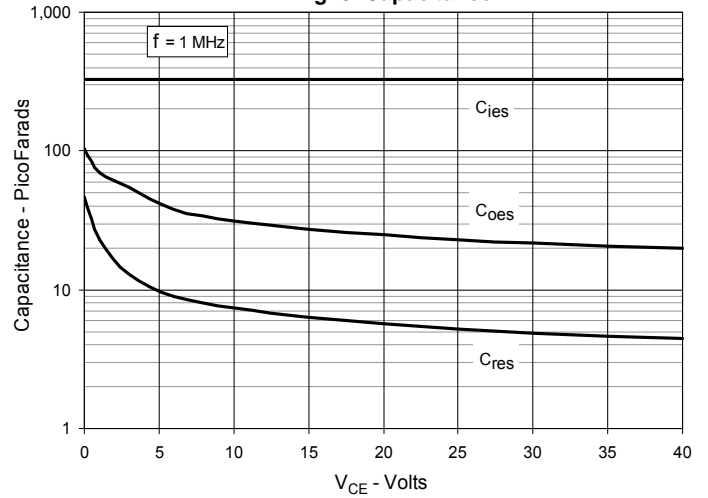

Fig. 9. Reverse-Bias Safe Operating Area

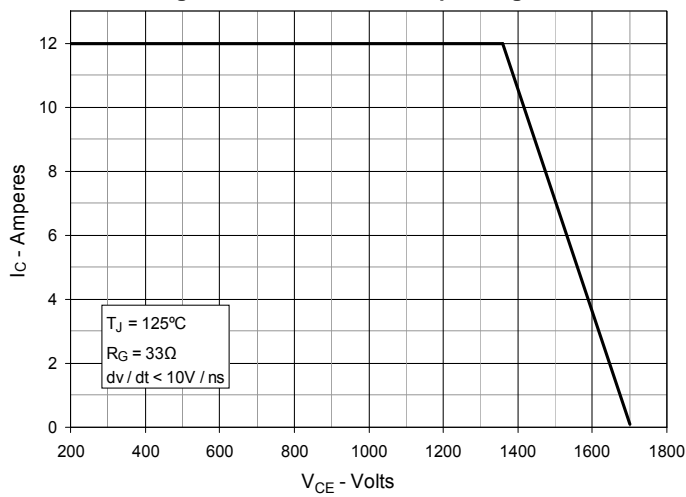

Fig. 10. Maximum Transient Thermal Impedance

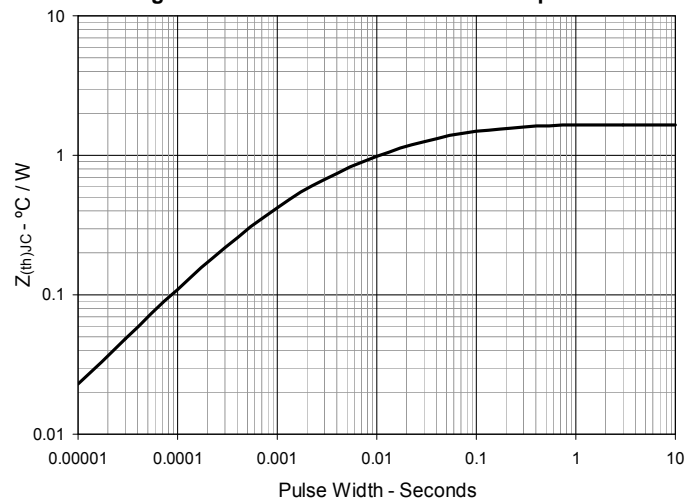
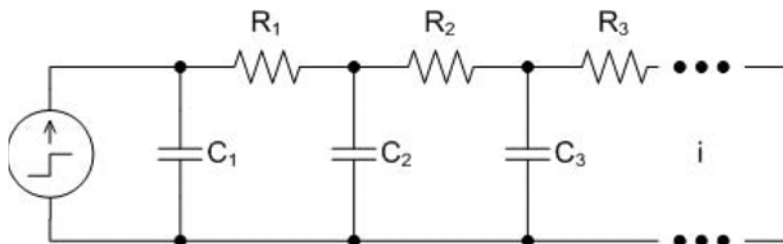

Fig. 11. Cauer Thermal Network



i	R_i ($^\circ\text{C/W}$)	C_i ($\text{J}/^\circ\text{C}$)
1	0.11615	0.0019257
2	0.29930	0.0016574
3	0.26377	0.0262960



Disclaimer Notice - Information furnished is believed to be accurate and reliable. However, users should independently evaluate the suitability of and test each product selected for their own applications. Littelfuse products are not designed for, and may not be used in, all applications. Read complete Disclaimer Notice at www.littelfuse.com/disclaimer-electronics.

Looking for pricing, stock, or lifecycle information?

Click below to explore more details on WIN SOURCE:

 [View IXGH6N170A on WIN SOURCE](#)

 [IXYS Information](#)

Optimize Your Supply Chain with WIN SOURCE Solutions

-  Global Sourcing Solution
-  Obsolete Management
-  Cost Control Management
-  Shortage Management
-  Alternative Solution
-  Excess Inventory Management