

nPM1300

Product Specification

v1.1

nPM1300

nPM1300 is a highly integrated Power Management IC (PMIC) for rechargeable applications. It is design compatible with an nRF52, nRF53, or nRF54 Series System on Chip (SoC) and nRF91 Series System in Package (SiP) for developing low-power wireless solutions.

nPM1300 has several power and system management features that can be implemented with dedicated components. Power management is achieved through flexible power regulation and a linear-mode lithium-ion (Li-ion), lithium-polymer (Li-poly), and lithium iron phosphate (LiFePO₄) battery charger in a compact 3.1x2.4 mm WLCSP or 5x5 mm QFN32 package. A minimum of 5 passive components are required.

nPM1300 supports charging up to 800 mA and delivers up to 500 mA of adjustable regulated voltage. Power is supplied to external components from two configurable, dual mode 200 mA BUCK regulators, and two dual purpose 50 mA LDO/100 mA load switches. In addition, an unregulated power rail delivers up to 1340 mA when powered from battery, or up to 1.5 A when powered from a USB port configured as DCP.

The host can read battery temperature, voltage, and current, which are utilized by a fuel gauge algorithm in the nRF Connect Software Development Kit. The fuel gauge provides the application with a battery state-of-charge estimate comparable to Coulomb counters at a significantly lower power consumption.

Low quiescent current (IQ) extends battery life during shipping and storage with Ship mode. Battery life can also be extended during operation with auto-controlled Hysteretic mode for high efficiency down to 1 μ A load currents.

The integrated system management features reduce the cost and size of applications. The following integrated features are found in the device:

- System-level watchdog
- Intelligent power-loss warning
- Ship and Hibernate modes for increased battery life
- Up to 5 GPIOs and 3 LED drivers
- System Monitor
- Fuel gauge when paired with an nRF52, nRF53, nRF54, or nRF91 Series host device

System management features and I/Os are configured through an I²C compatible two-wire Interface (TWI).

The nPM1300 Evaluation Kit allows for simple evaluation and code-free configuration of the nPM1300. By connecting to the nPM PowerUP app found in nRF Connect for Desktop, the nPM1300 settings can easily be configured through an intuitive GUI and exported as code to be implemented in your MCU's application.

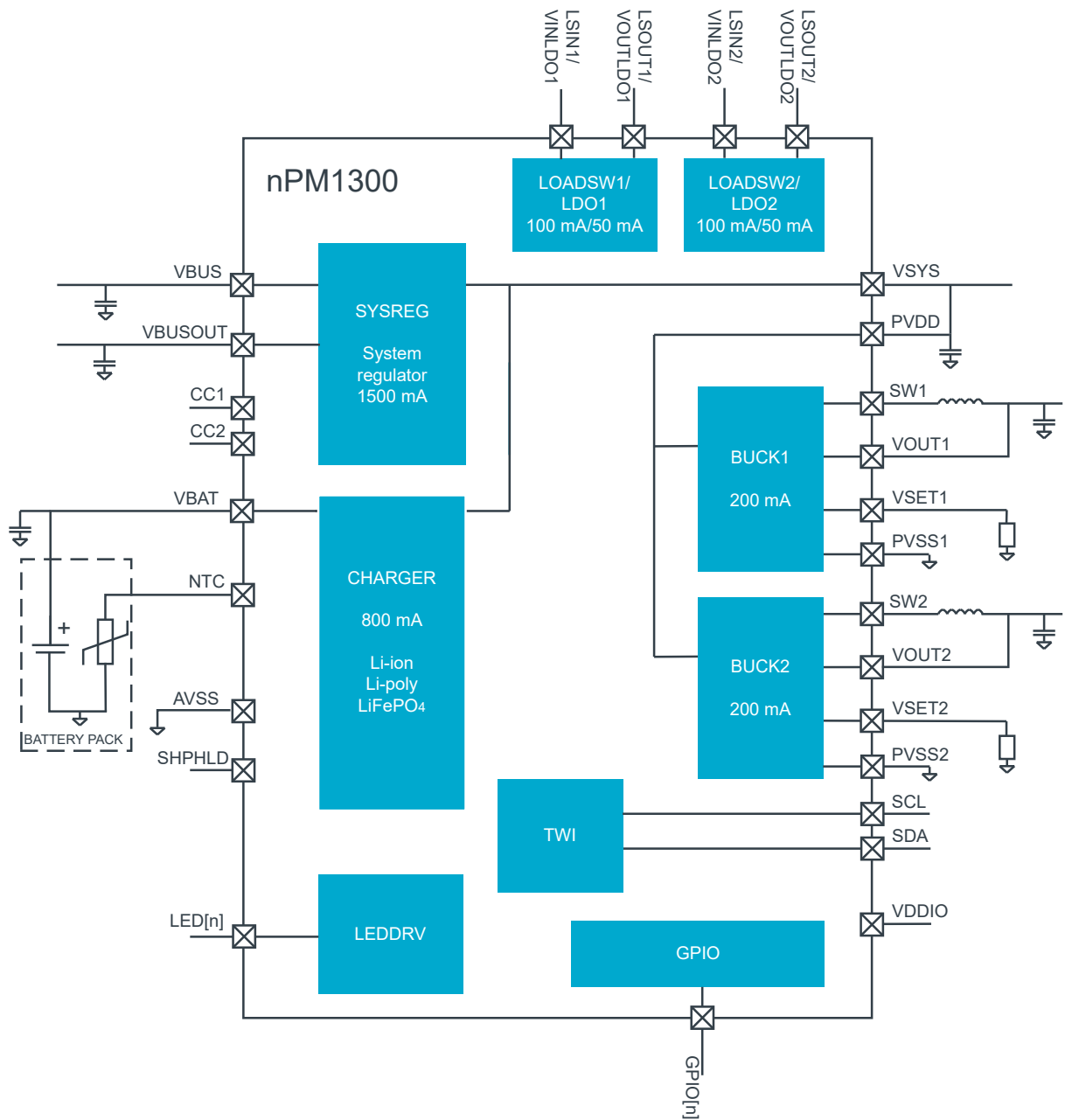

Figure 1: nPM1300

Key features

Features:

- 800 mA linear battery charger
 - Linear charger for lithium-ion, lithium-polymer, and lithium iron phosphate batteries
 - Configurable charge current from 32 mA to 800 mA
 - Charging termination voltage from 3.5 V to 4.45 V
 - Configurable thermal regulation
 - JEITA compliant
 - Dynamic power-path management
- Input current limiter
 - USB Type-C compliant
 - 4.0 V to 5.5 V operational input voltage range
 - 22 V tolerant
- Two 200 mA buck regulators
 - Automatic transition between Hysteretic and pulse width modulation (PWM) modes
 - Forced PWM mode for low-ripple operation
 - Pin-selectable output voltage
- Two 50 mA LDO/100 mA load switches
- I²C compatible TWI for control and monitoring
- 10-bit ADC for system monitoring
 - Measures VBUS voltage, battery voltage, current, and die temperature
- Three pre-configured and programmable 5 mA low-side LED drivers
- Configurable timer
 - Boot monitor
 - Watchdog timer with selectable reset or power cycling
 - Wake-up timer
 - General purpose timer
- Power-fail warning (POF)
- Configurable hard reset
- General purpose GPIOs that can control BUCKs, load switches, interrupt output, reset, power fail warning, or as a general purpose I/O
- Seamless integration and code free configuration with the nPM1300 Evaluation Kit and nPM PowerUp desktop app
- Package options available:
 - 3.1x2.4 mm WLCSP package
 - 5.0x5.0 mm QFN package

Applications:

- Wearables
 - Health/fitness sensor and monitoring devices
- Computer peripherals and I/O devices
 - Mouse
 - Keyboard
 - Multi-touch trackpad
- Asset trackers
- Interactive entertainment devices
 - Remote controls
 - Gaming controllers
- IoT applications
 - Smart/low-energy sensors
 - Loggers
 - Actuator controls

Contents

nPM1300	ii
Key features	iv
1 Revision history	8
2 About this document	9
2.1 Document status	9
2.2 Core component chapters	9
2.3 Register tables	9
2.3.1 Fields and values	10
2.3.2 Permissions	10
3 Product overview	11
3.1 Block diagram	11
3.1.1 In-circuit configurations	12
3.2 System description	13
3.3 Power-on reset (POR) and brownout reset (BOR)	14
3.4 Supported battery types	14
3.5 Thermal protection	14
3.6 System efficiency	14
3.7 Electrical characteristics	15
3.8 System electrical specification	16
4 Absolute maximum ratings	17
5 Recommended operating conditions	18
5.1 Dissipation ratings	18
5.2 WLCSP light sensitivity	19
6 Core Components	20
6.1 SYSREG — System regulator	20
6.1.1 VBUS input current limiter	20
6.1.2 VBUS overvoltage protection	20
6.1.3 USB port detection	20
6.1.4 USB2.0 Selective Suspend	21
6.1.5 VBUSOUT	21
6.1.6 Electrical specification	21
6.1.7 Electrical characteristics	22
6.1.8 Registers	23
6.2 CHARGER — Battery charger	26
6.2.1 Charging cycle	27
6.2.2 Battery detection and UVLO	28
6.2.3 Termination voltage (VTERMSET)	28
6.2.4 Charge current limit (ICHG)	28
6.2.5 Monitor battery temperature	29
6.2.6 Charger thermal regulation	30
6.2.7 Charger error conditions	31

6.2.8 Charging status (CHG) and error indication (ERR).	31
6.2.9 End-of-charge and recharge.	32
6.2.10 Dynamic power-path management.	32
6.2.11 Battery discharge current limit.	32
6.2.12 Electrical specification.	33
6.2.13 Electrical characteristics.	35
6.2.14 Registers.	36
6.3 BUCK — Buck regulators.	46
6.3.1 On/Off control.	46
6.3.2 Output voltage selection.	47
6.3.3 BUCK mode selection.	48
6.3.4 Active output capacitor discharge.	48
6.3.5 Component selection.	48
6.3.6 Electrical specification.	49
6.3.7 Electrical characteristics.	50
6.3.8 Registers.	62
6.4 LOADSW/LDO — Load switches/LDO regulators.	71
6.4.1 Electrical specification.	72
6.4.2 Electrical characteristics.	73
6.4.3 Registers.	75
6.5 LEDDRV — LED drivers.	81
6.5.1 Electrical specification.	81
6.5.2 Registers.	82
6.6 GPIO — General purpose input/output.	84
6.6.1 Pin configuration.	85
6.6.2 Electrical specification.	86
6.6.3 Registers.	87
7 System features	97
7.1 System Monitor.	97
7.1.1 Single-shot measurements.	97
7.1.2 Automatic measurements.	98
7.1.3 Timed measurements.	98
7.1.4 Measurement results.	98
7.1.5 Events and interrupts.	100
7.1.6 Battery temperature measurement.	100
7.1.7 Monitor battery state of charge.	100
7.1.8 Battery current measurement.	100
7.1.9 Electrical specification.	101
7.1.10 Registers.	101
7.2 POF — Power-fail comparator.	108
7.2.1 Electrical specification.	109
7.2.2 Registers.	110
7.3 TIMER — Timer/monitor.	111
7.3.1 Boot monitor.	112
7.3.2 Watchdog timer.	112
7.3.3 Wake-up timer.	113
7.3.4 General purpose timer.	113
7.3.5 Electrical specification.	113
7.3.6 Registers.	114
7.4 Sleep and Hibernate modes.	117
7.4.1 Electrical specification.	117
7.4.2 Registers.	118
7.5 RESET — Reset control.	120

7.6 TWI — I ² C compatible two-wire interface.	121
7.6.1 TWI timing diagram.	122
7.6.2 Electrical specification.	122
7.7 Event and interrupt registers.	122
7.7.1 Registers.	123
7.8 Reset and error registers.	144
7.8.1 Registers.	145
8 Application.	148
8.1 Schematic.	148
8.2 Supplying from BUCK.	148
8.3 USB port negotiation.	149
8.4 Charging and error states.	149
8.5 Termination voltage and current.	149
8.6 NTC thermistor configuration.	149
8.7 Ship mode.	149
9 Hardware and layout.	150
9.1 Pin assignments.	150
9.1.1 QFN32 pin assignments.	150
9.1.2 WLCSP ball assignments.	152
9.2 Mechanical specifications.	154
9.2.1 QFN32 5x5 mm package.	154
9.2.2 WLCSP package.	154
9.3 Reference circuitry.	155
9.3.1 Configuration 1.	156
9.3.2 Configuration 2.	158
9.3.3 Configuration 3.	159
9.3.4 PCB guidelines.	161
9.3.5 PCB layout example.	161
10 Ordering information.	165
10.1 IC marking.	165
10.2 Box labels.	165
10.3 Order code.	166
10.4 Code ranges and values.	167
10.5 Product options.	168
11 Legal notices.	170

1 Revision history

Date	Version	Description
July 2024	1.1	The following has been added or updated: <ul style="list-style-type: none">• Battery current measurement on page 100• Battery discharge current limit on page 32
October 2023	1.0	First release

2 About this document

This document is organized into chapters that are based on the modules available in the IC.

2.1 Document status

The document status reflects the level of maturity of the document.

Document name	Description
Objective Product Specification (OPS)	Applies to document versions up to 1.0. This document contains target specifications for product development.
Product Specification (PS)	Applies to document versions 1.0 and higher. This document contains final product specifications. Nordic Semiconductor ASA reserves the right to make changes at any time without notice in order to improve design and supply the best possible product.

Table 1: Defined document names

2.2 Core component chapters

Every core component has a unique capitalized name or an abbreviation of its name, e.g. LED, used for identification and reference. This name is used in chapter headings and references, and it will appear in the C-code header file to identify the component.

The core component instance name, which is different from the core component name, is constructed using the core component name followed by a numbered postfix, starting with 0, for example, LED0. A postfix is normally only used if a core component can be instantiated more than once. The core component instance name is also used in the C-code header file to identify the core component instance.

The chapters describing core components may include the following information:

- A detailed functional description of the core component
- Register configuration for the core component
- Electrical specification tables, containing performance data which apply for the operating conditions described in .

2.3 Register tables

Individual registers are described using register tables. These tables are built up of two sections. The first three colored rows describe the position and size of the different fields in the register. The following rows describe the fields in more detail.

2.3.1 Fields and values

The **Id (Field Id)** row specifies the bits that belong to the different fields in the register. If a field has enumerated values, then every value will be identified with a unique value id in the **Value Id** column.

A blank space means that the field is reserved and read as undefined, and it also must be written as 0 to secure forward compatibility. If a register is divided into more than one field, a unique field name is specified for each field in the **Field** column. The **Value Id** may be omitted in the single-bit bit fields when values can be substituted with a Boolean type enumerator range, e.g. true/false, disable(d)/enable(d), on/off, and so on.

Values are usually provided as decimal or hexadecimal. Hexadecimal values have a 0x prefix, decimal values have no prefix.

The **Value** column can be populated in the following ways:

- Individual enumerated values, for example 1, 3, 9.
- Range of values, e.g. [0..4], indicating all values from and including 0 and 4.
- Implicit values. If no values are indicated in the **Value** column, all bit combinations are supported, or alternatively the field's translation and limitations are described in the text instead.

If two or more fields are closely related, the **Value Id**, **Value**, and **Description** may be omitted for all but the first field. Subsequent fields will indicate inheritance with '..!'.

A feature marked **Deprecated** should not be used for new designs.

2.3.2 Permissions

Different fields in a register might have different access permissions enforced by hardware.

The access permission for each register field is documented in the **Access** column in the following ways:

Access	Description	Hardware behavior
RO	Read-only	Field can only be read. A write will be ignored.
WO	Write-only	Field can only be written. A read will return an undefined value.
RW	Read-write	Field can be read and written multiple times.
W1	Write-once	Field can only be written once per reset. Any subsequent write will be ignored. A read will return an undefined value.
RW1	Read-write-once	Field can be read multiple times, but only written once per reset. Any subsequent write will be ignored.

Table 2: Register field permission schemes

3 Product overview

nPM1300 is a highly integrated Power Management IC (PMIC) for rechargeable applications. It is design compatible with an nRF52, nRF53, or nRF54 Series System on Chip (SoC) and nRF91 Series System in Package (SiP) for developing low-power wireless solutions.

nPM1300 has several power and system management features that can be implemented with dedicated components. Power management is achieved through flexible power regulation and a linear-mode lithium-ion (Li-ion), lithium-polymer (Li-poly), and lithium iron phosphate (LiFePO₄) battery charger in a compact 3.1x2.4 mm WLCSP or 5x5 mm QFN32 package. A minimum of 5 passive components are required.

nPM1300 supports charging up to 800 mA and delivers up to 500 mA of adjustable regulated voltage. Power is supplied to external components from two configurable, dual mode 200 mA BUCK regulators, and two dual purpose 50 mA LDO/100 mA load switches. In addition, an unregulated power rail delivers up to 1340 mA when powered from battery, or up to 1.5 A when powered from a USB port configured as DCP.

The host can read battery temperature, voltage, and current, which are utilized by a fuel gauge algorithm in the nRF Connect Software Development Kit. The fuel gauge provides the application with a battery state-of-charge estimate comparable to Coulomb counters at a significantly lower power consumption.

Low quiescent current (IQ) extends battery life during shipping and storage with Ship mode. Battery life can also be extended during operation with auto-controlled Hysteretic mode for high efficiency down to 1 µA load currents.

The integrated system management features reduce the cost and size of applications. The following integrated features are found in the device:

- System-level watchdog
- Intelligent power-loss warning
- Ship and Hibernate modes for increased battery life
- Up to 5 GPIOs and 3 LED drivers
- System Monitor
- Fuel gauge when paired with an nRF52, nRF53, nRF54, or nRF91 Series host device

System management features and I/Os are configured through an I²C compatible two-wire Interface (TWI).

The nPM1300 Evaluation Kit allows for simple evaluation and code-free configuration of the nPM1300. By connecting to the nPM PowerUP app found in nRF Connect for Desktop, the nPM1300 settings can easily be configured through an intuitive GUI and exported as code to be implemented in your MCU's application.

3.1 Block diagram

The block diagram illustrates the overall system.

Pin	Function	Reference
VDDIO	Supply for the TWI control interface and GPIOs	Interface supply on page 121, GPIO — General purpose input/output on page 84
VSET1	BUCK1 enable and VOUT1 voltage level selection at power-on reset	BUCK — Buck regulators on page 46
VSET2	BUCK2 enable and VOUT2 voltage level selection at power-on reset	BUCK — Buck regulators on page 46
CC1, CC2	USB charger detection (USB Type-C)	USB port detection on page 20

Table 3: In-circuit configurations

3.2 System description

The device has the following core components that are described in detail in their respective chapters.

- [SYSREG — System regulator](#) on page 20
- [CHARGER — Battery charger](#) on page 26
- [BUCK — Buck regulators](#) on page 46
- [LOADSW/LDO — Load switches/LDO regulators](#) on page 71
- [LEDDRV — LED drivers](#) on page 81
- [GPIO — General purpose input/output](#) on page 84

The system regulator (SYSREG) is supplied by VBUS. It supports 4.0 V to 5.5 V for internal functions and tolerates transient voltages up to 22 V. Overvoltage protection is implemented for both internal and external circuitry. SYSREG also implements current limiting for VBUS to comply with the USB Type-C specification. SYSREG supports Type-C charger detection.

The battery charger (CHARGER) is a JEITA compliant linear battery charger for lithium-ion (Li-ion), lithium-polymer (Li-poly), and lithium iron phosphate (LiFePO₄) batteries. CHARGER controls the charge cycle using a standard Li-ion charge profile. CHARGER implements dynamic power-path management regulating current in and out of the battery, depending on system requirements, to ensure immediate system operation from VBUS if the battery is depleted. Safety features, such as [battery temperature monitoring](#) and [charger thermal regulation](#) are supported.

Two independent, highly efficient buck regulators (BUCK) supply the application circuitry and offer several output voltage options. BUCK is controlled through registers or GPIO pins. Default output voltage can be set with external resistors.

The two load switches (LOADSW/LDO) can function as switches or linear voltage regulators to complement the power distribution network. LOADSW/LDO is controlled through registers or GPIO pins.

The System Monitor provides measurements for battery voltage, battery current, VBUS, battery, and die temperature.

GPIO has the following configurable features:

- General purpose input
- Control input
- Output
- BUCK[n] control
- LOADSW[n] control

The device also features [Ship and Hibernate modes](#), the lowest quiescent current states. They disconnect the battery from the system and reduce the quiescent current of the device to extend battery life. Hibernate mode can be utilized during normal operation as the device can autonomously wake-up after a preconfigured timeout. This makes it possible to extend battery life to the maximum capacity.

3.3 Power-on reset (POR) and brownout reset (BOR)

The device is supplied by **VBUS** or **VBAT**.

When one of the following conditions are met, a power-on reset (POR) occurs.

- **VBUS** > $VBUS_{POR}$
- **VBAT** > $VBAT_{POR}$

When both of the following conditions are met, a brownout reset (BOR) occurs.

- **VBUS** < $VBUS_{BOR}$
- **VBAT** < $VBAT_{BOR}$

3.4 Supported battery types

The charger supports rechargeable Li-ion, Li-polymer, or LiFePO₄ batteries.

Battery packs connected to the **VBAT** pin must contain the following protection circuitry:

- Overvoltage protection
- Undervoltage protection
- Overcurrent discharge protection
- Thermal fuse to protect from overtemperature (if NTC thermistor is not present)

3.5 Thermal protection

A global thermal shutdown is triggered when the die temperature exceeds the operating temperature range, see [TSD](#). All device functions are disabled in thermal shutdown. The device functions are re-enabled when the temperature is sufficiently reduced according to a hysteresis TSD_{HYST} .

A secondary mechanism disables the charger when the die reaches the host software programmable temperature of [DIETEMPSTOP](#) on page 43 . Once this temperature is reached, charging stops but all other functionality remains active. Charging restarts when the die temperature reaches the host software programmable temperature of [DIETEMPRESUME](#) on page 44.

3.6 System efficiency

Shown here is the characterization of the power path system efficiency under different load current conditions.

In the following figure, the load current is swept from 100 nA to 200 mA and back to capture mode change hysteresis.

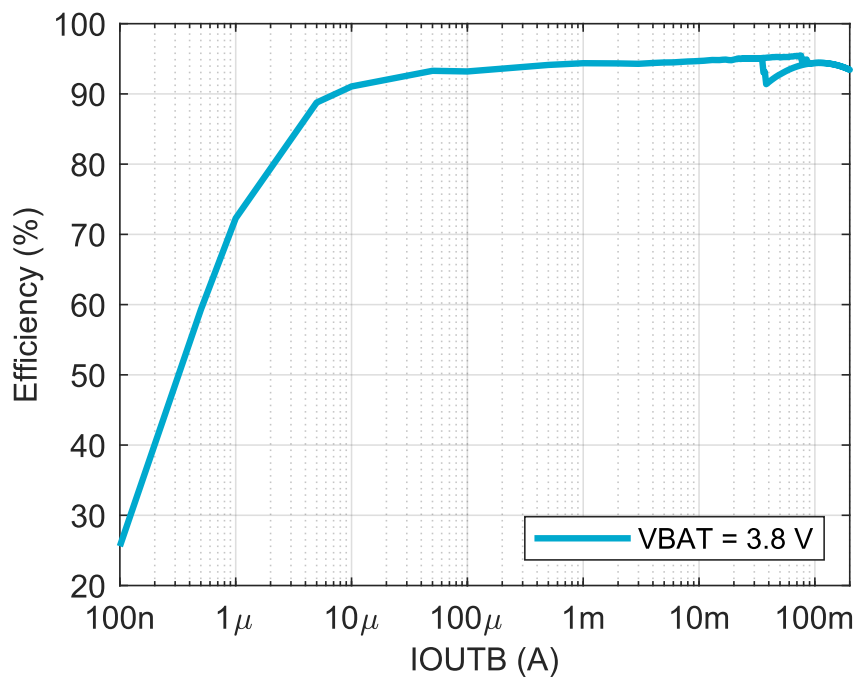

Figure 3: VOUT = 3.3 V system efficiency, MODE = AUTO, VIN = 3.8 V

3.7 Electrical characteristics

The following graphs show quiescent current characteristics.

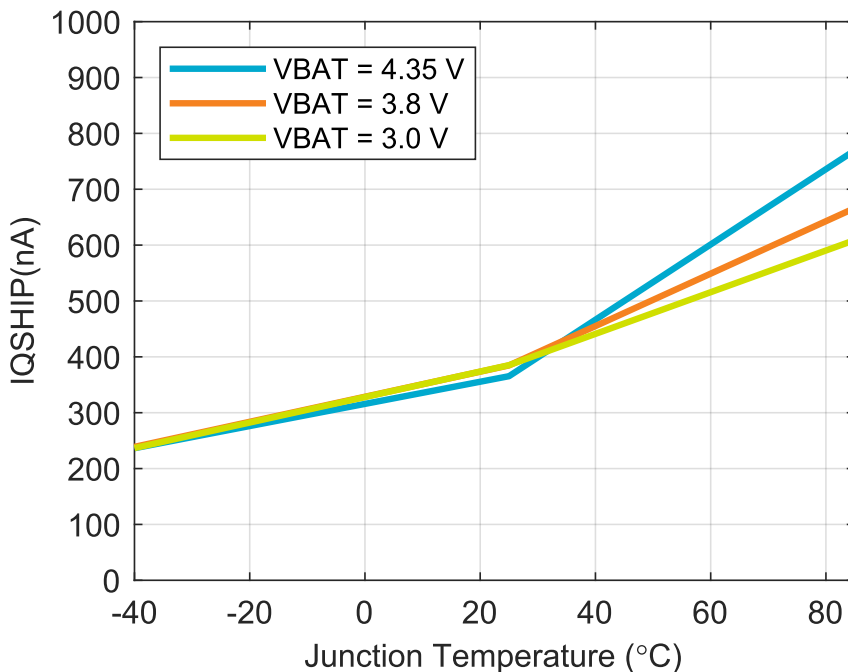

Figure 4: SHIP mode current vs. junction temperature

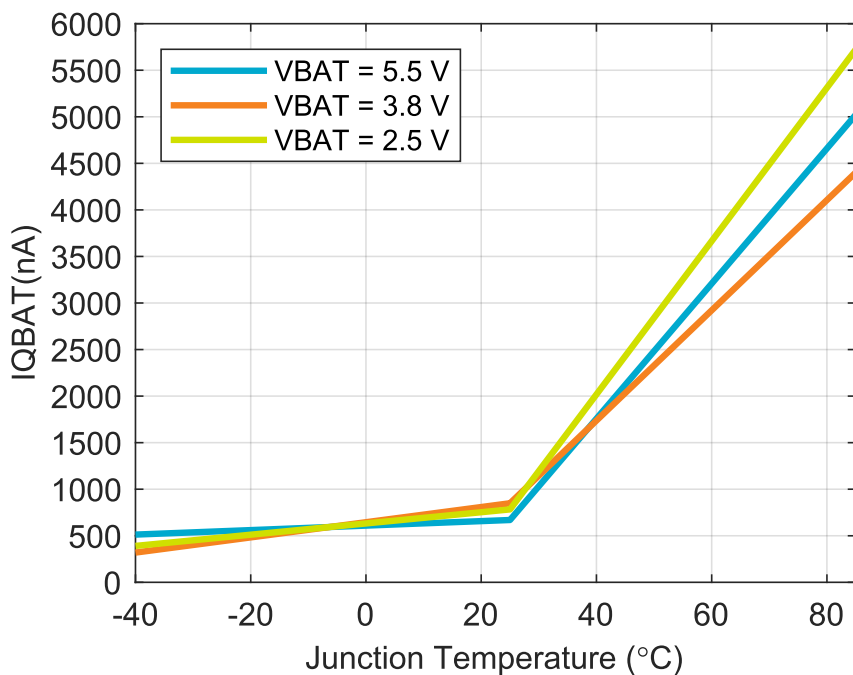

Figure 5: Discharge mode current vs. junction temperature

3.8 System electrical specification

Symbol	Description	Min.	Typ.	Max.	Unit
I_{Q_SHIP}	Ship mode quiescent current		370		nA
I_{Q_SHIPT}	Hibernate mode quiescent current		500		nA
I_{Q_BAT}	Quiescent current, battery operation, no BUCK load, VBUS disconnected		800		nA
TSD	Thermal shutdown threshold		120		°C
TSD _{HYST}	Thermal shutdown hysteresis		20		°C

Table 4: System electrical specification

4 Absolute maximum ratings

Maximum ratings are the extreme limits to which the device can be exposed for a limited amount of time without permanently damaging it. Exposure to absolute maximum ratings for prolonged periods of time may affect the reliability of the device.

Pin	Note	Min.	Max.	Unit
VBUS	Power	-0.3	22	V
VBAT, VSYS, PVDD	Power	-0.3	5.5	V
AVSS, PVSS1, PVSS2	Power		0	V
VDDIO	Power	-0.3	5.5	V
NTC, CC1, CC2, SHPHLD, LED0, LED1, LED2, LSIN1/VINLDO1, LSOUT1/VOUPLDO1, LSIN2/VINLDO2, LSOUT2/VOUPLDO2, VSET1, VSET2, VBUSOUT, VOUT1, VOUT2, SW1, SW2	Analog pins	-0.3	5.5	V
GPIO [0 . . 4], SDA, SCL	Digital pins	-0.3	VDDIO+0.3	V

Table 5: Absolute maximum ratings

	Note	Min.	Max.	Unit
Storage temperature		-40	+125	°C
MSL QFN	Moisture sensitivity level		2	
MSL WLCSP	Moisture sensitivity level		1	
ESD HBM	Human Body Model Class 2		2	kV
ESD CDM	Charged Device Model		500	V

Table 6: Environmental ratings



5 Recommended operating conditions

The operating conditions are the physical parameters that the chip can operate within.

Symbol	Description	Min.	Max	Unit
$V_{BUS_{OP}}$	Supply voltage	4.0	5.5	V
$V_{BAT_{OP}}$	Battery voltage	2.3	4.45	V
VDDIO	I/O supply voltage	1.7	VSYS	V
T_J	Junction temperature	-40	+125	°C
T_A	Ambient temperature	-40	+85	°C

Table 7: Recommended operating conditions

Note: Any system features powered by VSYS will only operate when the VSYS voltage > VSYS_{POF}.

5.1 Dissipation ratings

Thermal resistances and thermal characterization parameters as defined by JESD51-7 are shown in the following tables.

Symbol	Parameter	QFN 32 pins	Units
$R_{\theta JA}$	Junction-to-ambient thermal resistance	24.2	°C/W
$R_{\theta JC(top)}$	Junction-to-case (top) thermal resistance	10.7	°C/W
$R_{\theta JB}$	Junction-to-board thermal resistance	8.8	°C/W
Ψ_{JT}	Junction-to-top characterization parameter	0.15	°C/W
Ψ_{JB}	Junction-to-board characterization parameter	8.9	°C/W

Table 8: QFN32 thermal resistance and characterization parameters

Symbol	Parameter	WLCSP 35 pins	Units
$R_{\theta JA}$	Junction-to-ambient thermal resistance	48.3	°C/W
$R_{\theta JC(top)}$	Junction-to-case (top) thermal resistance	6.0	°C/W
$R_{\theta JB}$	Junction-to-board thermal resistance	23.0	°C/W
Ψ_{JT}	Junction-to-top characterization parameter	0.5	°C/W
Ψ_{JB}	Junction-to-board characterization parameter	23.4	°C/W

Table 9: WLCSP thermal resistance and characterization parameters

5.2 WLCSP light sensitivity

WLCSP package is sensitive to light.

All WLCSP package variants are sensitive to visible and close-range infrared light. The final product design must shield the chip through encapsulation or shielding/coating the WLCSP device.

WLCSP package variant CAAA has a backside coating that covers the marking side of the device with a light absorbing film. The side edges and the ball side of the device are still exposed and need to be protected.

6 Core Components

6.1 SYSREG — System regulator

VBUS supplies the input voltage to the system regulator (SYSREG). VBUS voltage is supplied by an AC wall adapter or a USB port.

SYSREG supplies V_{SYS}.

Features of SYSREG are the following:

- Operating voltage up to 5.5 V
- Overvoltage protection to 22 V
- Undervoltage detection
- USB port detection and a current limiter to comply with the USB specification
- Provides **VBUSOUT** voltage for nRF5x series devices

6.1.1 VBUS input current limiter

The VBUS input current limiter manages VBUS current limitation and charger detection for USB Type-C compatible chargers.

It supplies **V_{SYS}** but does not regulate its voltage. VBUS voltage is seen at **V_{SYS}** as a supply, if the VBUS voltage is within specified limits.

There are two USB compliant, accurate current limits: **IBUS_{100MA}** (100 mA) and **IBUS_{500MA}** (500 mA).

In addition, there are current limits in 100 mA steps from 600 mA to 1500 mA. The 1500 mA limit is compatible with USB Type-C.

The default current limit is **IBUS_{100MA}** (100 mA). Host software can configure the current in register **VBUSINILIMO** on page 24. When **TASK.UPDATE.ILIMSW** is written, **VBUSIN.LIMO** takes effect.

6.1.2 VBUS overvoltage protection

The overvoltage threshold for **VBUS** is **VBUS_{OVP}**. The undervoltage threshold for **VBUS** is **VBUS_{MIN}**.

SYSREG is disabled when **VBUS_{voltage}** is above the overvoltage threshold **VBUS_{OVP}**, or below the undervoltage threshold **VBUS_{MIN}**. This isolates **VBUS** and prevents current flowing from **V_{SYS}** to **VBUS**.

6.1.3 USB port detection

USB charger detection is performed through pins **CC1** and **CC2**. These pins must be connected directly to the USB connector for detection to happen.

These pins have internal pull-downs with resistance equal to **R_d**.

When the device is plugged into a wall adaptor or USB power source, USB port detection runs automatically. One of the CC lines is connected to a pull-up at the source. The other CC line stays pulled down. The voltage over the corresponding **R_d** determines if a connection was made and if SYSREG can deliver 500 mA or higher current.

Comparators with thresholds at **V_{RDCONN}**, **V_{RD1A5}**, and **V_{RD3A}** monitor CC line voltage when VBUS is present. All comparator output is debounced with **t_{RDDEB}** and available to host software through register **USBCDETECTSTATUS** on page 25.

If enabled, an interrupt is issued to the host whenever a threshold is crossed (when voltage decreases or increases). The events are visible in register `EVENTSVBUSIN1SET` on page 139.

The USB power source capability is detected by one CC line at a time, depending on the orientation of the USB plug on the device. The other CC line remains at 0 V. The charger type is defined in the `VBUSIN.CC1CMP` or `VBUSIN.CC2CMP` field, depending on which pin is used for connection.

The default VBUS current limit of 100 mA is used until the power source capability is detected. Host software can update the VBUS current limit in `VBUSINILIMO` on page 24 after device detection. When a USB cable is unplugged and plugged back in, or a reset occurs, the default current limit is used.

When `TASK.UPDATE.ILIMSW` is written, `VBUSIN.LIMO` takes effect. The VBUS current limit reverts to its default value (100 mA) when the following occur:

- A reset
- The USB cable is unplugged and plugged back in

If USB Type-C configuration is not used, `CC1` and `CC2` can be left floating or connected to ground. The default VBUS current limit will remain at 100 mA until the host negotiates and configures a higher current.

Note: Overvoltage or undervoltage events may occur when connecting or removing a supply to **VBUS**.

6.1.4 USB2.0 Selective Suspend

The device can satisfy USB2.0 Selective Suspend mode current consumption through configuration. It must be informed by host software through the TWI in register `VBUSSUSPEND` on page 25 to minimize current consumption from VBUS to I_{SUSP} .

The current consumed through pin **VBUSOUT** is not included. VBUS is disconnected from VSYS but **VBUSOUT** remains active. As a consequence, charging is paused. The device exits this mode only when instructed by the host software through a TWI command. Charging resumes automatically.

6.1.5 VBUSOUT

The device supplies **VBUSOUT** voltage when **VBUS** voltage is present.

VBUSOUT provides overvoltage and undervoltage protection for safe connection to the nRF device. Designs using the **VBUSOUT** pin as a supply must make sure the voltage level complies with the nRF device due to output resistance $R_{VBUSOUT}$. When USB is suspended, the combined current for nPM1300 and the **VBUSOUT** pin must be within the allowed USB suspend current.

VBUSOUT must have a decoupling capacitor.

6.1.6 Electrical specification

Symbol	Description	Min.	Typ.	Max.	Unit
VBUS _{OVP}	Oversvoltage protection threshold		5.5		V
VBUS _{POR}	Power-on reset release voltage for VBUS		3.9		V
VBUS _{BOR}	Brownout reset trigger for VBUS with VBAT not present		3.8		V
VBUS _{MIN}	Undervoltage threshold with VBAT present		3.6		V
IBUS _{100MA}	VBUS input current limit, 100 mA ¹			95	mA
IBUS _{500MA}	VBUS input current limit, 500 mA ¹			495	mA
IBUS _{LIMACC}	Accuracy of IBUS current limit (steps from 600 to 1500 mA) ¹	-10		+10	%
I _{SUSP}	VBUS current consumption in suspend mode Current from VBUSOUT is excluded		1.8		mA
R _{ON}	Resistance between VBUS and VSYS VBUSINLIM0 = 15 (1.5 A) VBUS = 5 V		300		mΩ
R _{VBUSOUT}	On resistance of the VBUSOUT switch VBUS = 5.0 V		7.5		Ω
R _d	Pull-down resistance on pins CC1 and CC2		5.1		kΩ
V _{RDCONN}	Threshold to detect connection		0.2		V
V _{RD1A5}	Threshold to detect charger type on CC1 or CC2 pins		0.66		V
V _{RD3A}	Threshold for 3 A current limit		1.23		V
t _{RDDEB}	Debounce time for CC voltage level detection		15		ms

Table 10: SYSREG electrical specification

¹Includes internal device consumption and current flowing through pin **VBUSOUT**.

6.1.7 Electrical characteristics

The following graphs show typical electrical characteristics for VBUSIN.

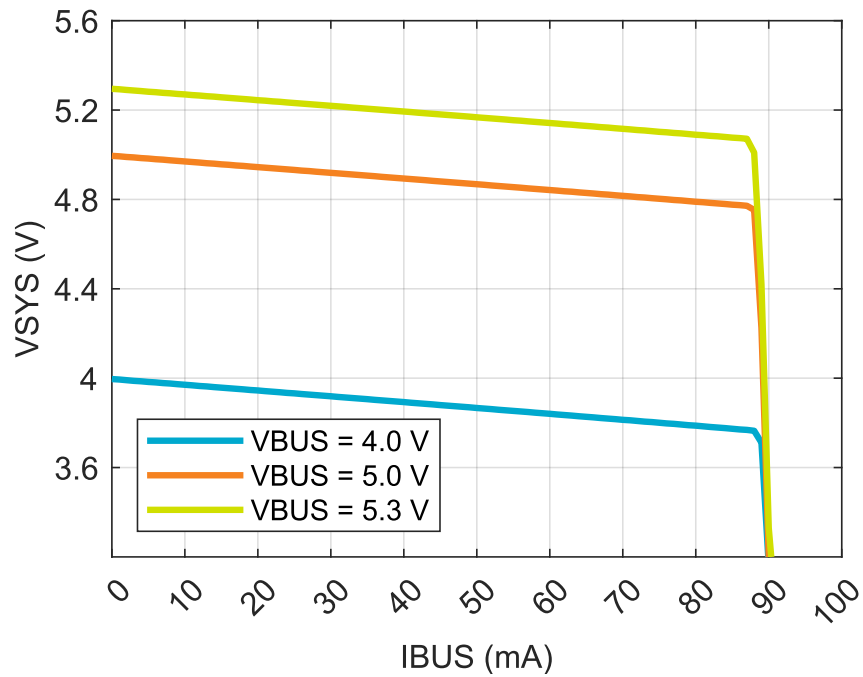

Figure 6: VSYS voltage vs. VBUS current, ILIM = 100 mA

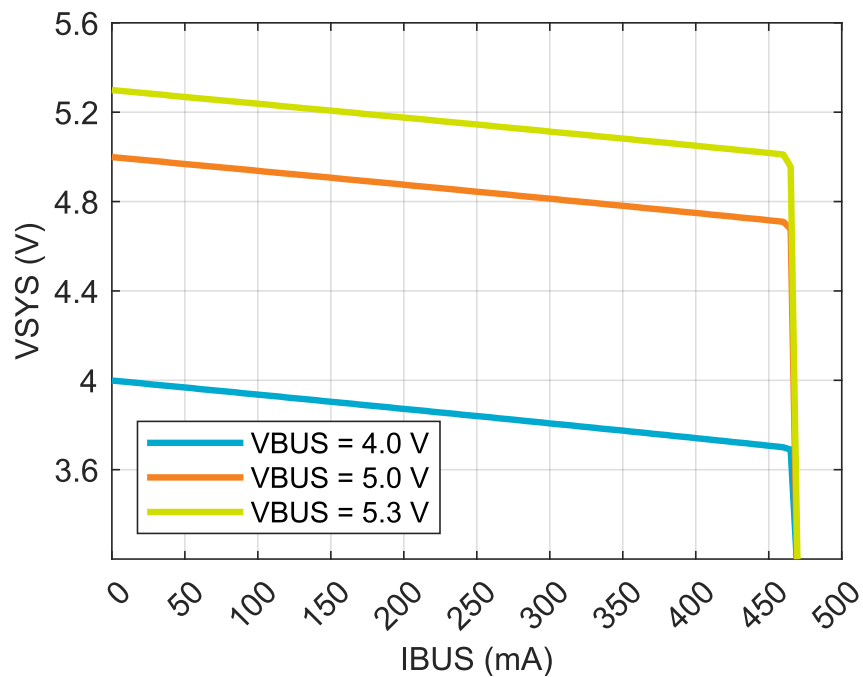

Figure 7: VSYS voltage vs. VBUS current, ILIM = 500 mA

6.1.8 Registers

Instances

Instance	Base address	Description
VBUSIN	0x00000200	VBUSIN registers VBUSIN register map

Register overview

Register	Offset	Description
TASKUPDATEILIMSW	0x0	Select Input Current limit for VBUS
VBUSINILIMO	0x1	Select Input Current limit for VBUS NOTE: Reset value from OTP, value listed in this table may not be correct.
VBUSINILIMSTARTUP	0x2	Select input Current limit for VBUS at Startup
VBUSSUSPEND	0x3	Suspend mode enable
USBCDETECTSTATUS	0x5	VBUS CC comparator status flags
VBUSINSTATUS	0x7	VBUS status flags

6.1.8.1 TASKUPDATEILIMSW

Address offset: 0x0

Select Input Current limit for VBUS

Bit number	7 6 5 4 3 2 1 0						
ID	A						
Reset 0x00	0 0 0 0 0 0 0 0						
ID	R/W	Field	Value ID	Value	Description		
A	W	TASKUPDATEILIM			Set to switch from vbusinlimStartup to vbusinlim0		
			NOEFFECT	0	No effect		
			SELVBUSILIMO	1	Set to use vbusinlim0. Vbus removal results in switch back to vbusinlimStartup		

6.1.8.2 VBUSINILIMO

Address offset: 0x1

Select Input Current limit for VBUS NOTE: Reset value from OTP, value listed in this table may not be correct.

Bit number	7 6 5 4 3 2 1 0						
ID	A A A A						
Reset 0x00	0 0 0 0 0 0 0 0						
ID	R/W	Field	Value ID	Value	Description		
A	RW	VBUSINILIMO			Input current limit for VBUS selected by Host		
			500MA0	0	500mA		
			100MA	1	100mA		
			200MA	2	200mA		
			300MA	3	300mA		
			400MA	4	400mA		
			500MA	5	500mA		
			600MA	6	600mA		
			700MA	7	700mA		
			800MA	8	800mA		
			900MA	9	900mA		
			1000MA	10	1000mA		
			1100MA	11	1100mA		
			1200MA	12	1200mA		
			1300MA	13	1300mA		
			1400MA	14	1400mA		
			1500MA	15	1500mA		

6.1.8.3 VBUSINILIMSTARTUP

Address offset: 0x2

Select input Current limit for VBUS at Startup

Bit number	7	6	5	4	3	2	1	0
ID					A	A	A	A
Reset 0x00	0	0	0	0	0	0	0	0

ID	R/W	Field	Value ID	Value	Description
A	RW	VBUSINILIMSTARTUP			Default input current selection
			500MA0	0	500mA
			100MA	1	100mA
			200MA	2	200mA
			300MA	3	300mA
			400MA	4	400mA
			500MA	5	500mA
			600MA	6	600mA
			700MA	7	700mA
			800MA	8	800mA
			900MA	9	900mA
			1000MA	10	1000mA
			1100MA	11	1100mA
			1200MA	12	1200mA
			1300MA	13	1300mA
			1400MA	14	1400mA
			1500MA	15	1500mA

6.1.8.4 VBUSSUSPEND

Address offset: 0x3

Suspend mode enable

Bit number	7	6	5	4	3	2	1	0
ID								A
Reset 0x00	0	0	0	0	0	0	0	0

ID	R/W	Field	Value ID	Value	Description
A	RW	VBUSSUSPENDENA			VBUS suspend control bit
			NORMAL	0	Normal mode
			SUSPENDMODE	1	Suspend Mode

6.1.8.5 USBCDETECTSTATUS

Address offset: 0x5

VBUS CC comparator status flags

Bit number						7	6	5	4	3	2	1	0
ID						B		B		A		A	
Reset 0x00						0	0	0	0	0	0	0	0
ID	R/W	Field	Value ID	Value	Description								
A	R	VBUSINCC1CMP			CC1 Charger detection comparator output								
			NOCONNECTION	0	no connection								
			DEFAULTUSB	1	Default USB 100/500mA								
			1A5HIGHPOWER	2	1.5A High Power								
			3AHIGHPOWER	3	3A High Power								
B	R	VBUSINCC2CMP			CC2 Charger detection comparator output								
			NOCONNECTION	0	no connection								
			DEFAULTUSB	1	Default USB 100/500mA								
			1A5HIGHPOWER	2	1.5A High Power								
			3AHIGHPOWER	3	3A High Power								

6.1.8.6 VBUSINSTATUS

Address offset: 0x7

VBUS status flags

Bit number						7	6	5	4	3	2	1	0
ID						F		E		D		C B A	
Reset 0x00						0	0	0	0	0	0	0	0
ID	R/W	Field	Value ID	Value	Description								
A	R	VBUSINPRESENT			VBUS detected								
			NOTDETECTED	0	NotDetected								
			DETECTED	1	Detected								
B	R	VBUSINCURRLIMACTIVE			VBUS Current limit detected								
			NOTDETECTED	0	NotDetected								
			DETECTED	1	Detected								
C	R	VBUSINOVRPROTACTIVE			VBUS Overvoltage protection Active								
			NOTACTIVE	0	NotActive								
			ACTIVE	1	Active								
D	R	VBUSINUNDERVOLTAGE			VBUS Undervoltage detected								
			NOTDETECTED	0	NotDetected								
			DETECTED	1	Detected								
E	R	VBUSINSUSPENDMODEACTIVE			VBUS suspended								
			NORMAL	0	Normal								
			SUSPEND	1	Suspended								
F	R	VBUSINVBUSOUTACTIVE			VBUS Out Active								
			NOTACTIVE	0	NotActive								
			ACTIVE	1	Active								

6.2 CHARGER — Battery charger

The battery charger is suitable for general purpose applications with lithium-ion (Li-ion), lithium-polymer (Li-poly), and lithium iron phosphate (LiFePO₄) batteries. The following sections describe how to configure CHARGER to match the battery type.

The main features of the battery charger are the following:

- Linear charger for Li-ion, Li-poly, and LiFePO₄ battery chemistries
- Bidirectional power FET for dynamic power-path management

- Automatic trickle, constant current, constant voltage, and end-of-charge/recharge cycle
- Maintains **VBUS** current below programmed limit
- JEITA compliant with a configurable battery charging temperature profile

Charging is configured and enabled through host software. The voltage and charging current are configurable and the device manages the charging cycle after the charging parameters are defined.

V_{TERM} must be set to a lower voltage than the battery overvoltage protection.

6.2.1 Charging cycle

Host software enables charging using register **BCHGENABLESET** on page 37. Battery charging starts when **VBUS** voltage is present.

When the battery is detected, trickle charging begins. Constant current charging starts when the battery voltage is above $V_{TRICKLE_FAST}$. After the battery voltage reaches V_{TERM} , the charger enters constant voltage charging. The battery voltage is maintained while monitoring current flow into the battery. When the current into the battery drops below I_{TERM} , charging is complete. Charging is disabled using register **BCHGENABLECLR** on page 38.

There is up to 100 ms of trickle charge and up to 4 ms of constant current charging if charging is enabled on a fully charged battery.

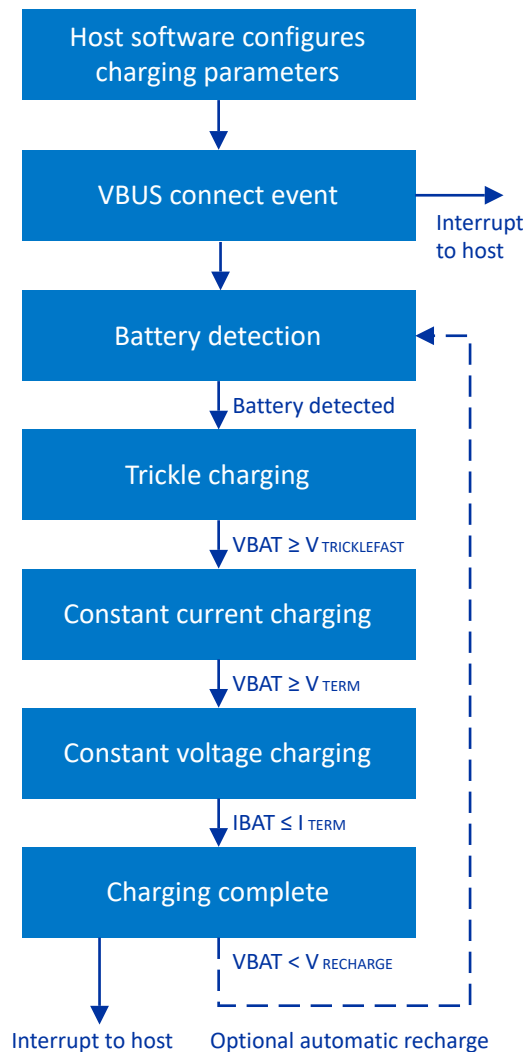

Figure 8: Charging cycle flow chart

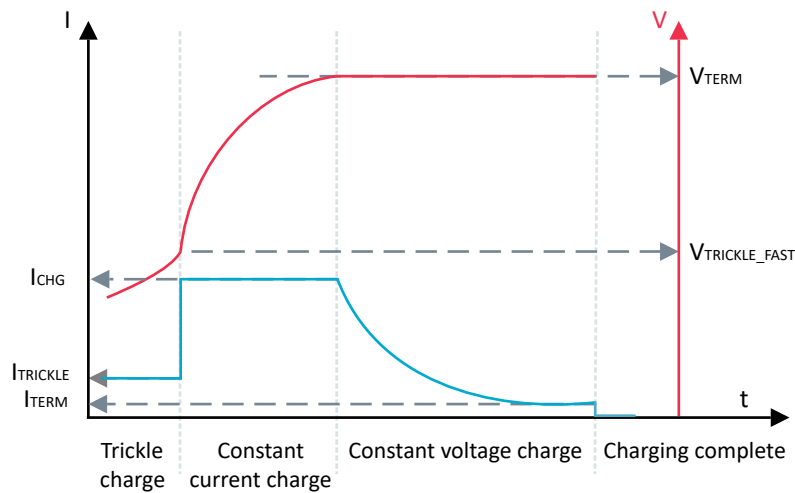

Figure 9: Charging cycle

6.2.2 Battery detection and UVLO

Battery detection runs automatically when charging starts. Battery UVLO will release when the battery voltage has increased above the UVLO threshold.

UVLO release refers to the overdischarge protection circuit in the battery pack protection circuit. It prevents battery loss when an overdischarge occurs. An undervoltage lockout circuit is not included on the device and must be set up on the battery pack.

CHARGER waits until a battery is detected before charging. A faulty or absent battery is indicated in bit **BATTERY DETECTED**.

If the system resets, charging control bits are reset and charging is disabled by default.

6.2.3 Termination voltage (VTERMSET)

V_{TERM} is configured through TWI according to the battery type in use, see register **BCHGVTERM** on page 40.

For a higher battery temperature range, a lower termination voltage (V_{TERMR}) is available and configured separately in register **BCHGVTERMR** on page 40. V_{TERM} and V_{TERMR} can be set to the same value.

6.2.4 Charge current limit (ICHG)

The charge current limit is set between 32 mA and 800 mA in 2 mA steps. Charging current I_{CHG} is configured with TWI with a default value of 32 mA.

CHARGER must be disabled before changing the current setting in registers **BCHGSETMSB** on page 39 and **BCHGSETLSB** on page 39. The setting takes effect when charging is enabled.

Charge current is configured using a 9-bit value. The following shows how the register value for **BCHGSETMSB** on page 39 can be calculated, where I_{CHG} is the charge current in mA:

$$I_{SETMSB} = \text{floor}\left(\frac{I_{CHG}}{4}\right)$$

The following shows how the register value for **BCHGSETLSB** on page 39 can be calculated, where I_{CHG} is the charge current in mA:

$$I_{SETLSB} = \begin{cases} 1, & \frac{I_{CHG}}{2} \text{ is odd} \\ 0, & \frac{I_{CHG}}{2} \text{ is even} \end{cases}$$

Some example charging currents are found in the following table.

I_{CHG}	BCHGISETMSB	BCHGISETLSB
32 mA	8	0
34 mA	8	1
400 mA	100	0
800 mA	200	0

Table 11: Charging current

Trickle charging current, I_{TRICKLE} , is 10% of I_{CHG} . Trickle charging is active when $V_{\text{BAT}} < V_{\text{TRICKLE_FAST}}$ (default 2.9 V).

Termination current, I_{TERM} , is programmable to 10% (default) or 20% of I_{CHG} . Termination current is active in the constant voltage phase of charging. Charging stops when the charging current reduces to this value.

These parameters are configured in registers [BCHGVTRICKLESEL](#) on page 41 and [BCHGITERMSEL](#) on page 41.

6.2.5 Monitor battery temperature

CHARGER supports three types of NTC thermistors for battery temperature (T_{BAT}) monitoring. Only one can be enabled at a time.

The host software must select the corresponding setting that matches the battery thermistor before enabling charging in register [ADCNTCRSEL](#) on page 104. The following thermistor resistors are supported.

Nominal resistance	Resistance accuracy	B25/50	Beta accuracy	B25/85
10 k Ω	1%	3380 K	1%	3434/3435 K
47 k Ω	1%	4050 K	1%	4108 K
100 k Ω	1%	4250 K	1%	4311 K

Table 12: Supported thermistor resistors

Note: If a capacitor is placed in parallel with the thermistor, the max capacitance is 100 pF.

If a thermistor is not used, the **NTC** pin must be tied directly to ground or through a resistor. The functionality must be disabled in register [BCHGDISABLESET](#) on page 38. This does not impact [Charger thermal regulation](#) on page 30.

The following battery temperature thresholds can be set: $T_{\text{COLD}} \leq T_{\text{COOL}} \leq T_{\text{WARM}} \leq T_{\text{HOT}}$.

These limits can be set between -20°C and $+60^{\circ}\text{C}$, and setting adjacent thresholds to identical values is allowed. For example, setting $T_{\text{WARM}} = T_{\text{HOT}}$ means that there is no warm region. Charging does not happen below T_{COLD} or above T_{HOT} . Charging can be paused at T_{WARM} instead of T_{HOT} by setting register [BCHGCONFIG](#) on page 46.

The thresholds are written into corresponding registers. The battery temperature variable, K_{NTCTEMP} , is calculated using the following equation:

$$K_{\text{NTCTEMP}} = \text{round}\left(1024 \cdot \frac{R_T}{R_T + R_B}\right)$$

Here, R_T is the thermistor resistance at a desired temperature and R_B (internal bias resistor) equals the thermistor resistance at 25°C. See [NTCCOLD](#) on page 41, [NTCCOOL](#) on page 42, [NTCWARM](#) on page 42, and [NTCHOT](#) on page 43 for more information. Default values in the registers match the JEITA guideline and are intended for the 10 kΩ thermistor defined in [Supported thermistor resistors](#) on page 29.

Temp.	10 kΩ	47 kΩ	100 kΩ	Register
0°C	749	787	799	NTCCOLD
10°C	658	684	693	NTCCOOL
45°C	337	306	297	NTCWARM
60°C	237	197	186	NTCHOT

Table 13: Battery temperature default values

The charging current can be reduced by 50% between NTCCOLD and NTCCOOL. The termination voltage can be configured independently between NTCWARM and NTCHOT. Default is I_{COOL} (50% of I_{CHG}), but this can be disabled.

Temperature region	Temperature limits, default setting	Charge current	Termination voltage
Cold	$T_{\text{BAT}} < T_{\text{COLD}}$ $T_{\text{COLD}} = 0^\circ\text{C}$	0 (OFF)	N/A
Cool	$T_{\text{COLD}} < T_{\text{BAT}} < T_{\text{COOL}}$ $T_{\text{COOL}} = 10^\circ\text{C}$	$I_{\text{COOL}} / I_{\text{CHG}}$	V_{TERM}
Nominal	$T_{\text{COOL}} < T_{\text{BAT}} < T_{\text{WARM}}$ $T_{\text{WARM}} = 45^\circ\text{C}$	I_{CHG}	V_{TERM}
Warm	$T_{\text{WARM}} < T_{\text{BAT}} < T_{\text{HOT}}$ $T_{\text{HOT}} = 60^\circ\text{C}$	I_{CHG}	V_{TERMR}
Hot	$T_{\text{BAT}} > T_{\text{HOT}}$	0 (OFF)	N/A

Table 14: Battery temperature regions

Battery temperature is measured by the on-chip System Monitor at regular intervals during charging. The latest result is available in registers [ADCNTCRESULTMSB](#) on page 106 and [ADCGPORESULTLSBS](#) on page 106.

When the battery temperature rises over T_{WARM} or T_{HOT} , or falls below T_{COOL} or T_{COLD} , an interrupt is sent.

6.2.6 Charger thermal regulation

Heat dissipation from the linear charger is managed by setting a maximum temperature limit for the die. This limit must not exceed device and PCB temperature requirements.

Die temperature monitoring is active during charging, with a default limit of T_{CHGSTOP} . Charging stops when the die temperature reaches the limit. It resumes when the die cools down to $T_{\text{CHGRESUME}}$.

T_{CHGSTOP} controls the junction temperature rise and limits the temperature rise on the PCB and device mechanics. The device can be configured to send an interrupt when the limit is met.

The die temperature variable, K_{DIETEMP} , is calculated with the following equation:

$$K_{\text{DIETEMP}} = \text{round}\left(\frac{394.67^{\circ}\text{C} - T_{\text{D}}}{0.7926}\right)$$

Here, T_{D} represents the die temperature limit in degrees Celsius.

Registers [DIETEMPSTOP](#) on page 43 and [DIETEMPSTOPLSB](#) on page 43 are concatenated to create a 10-bit value that defines the charging stop temperature T_{CHGSTOP} . Registers [DIETEMPRESUME](#) on page 44 and [DIETEMPRESUMELSB](#) on page 44 are concatenated to create a 10-bit value that defines the charging resume temperature $T_{\text{CHGRESUME}}$. The host software reads register [DIETEMPSTATUS](#) on page 45 to determine if the die temperature is above T_{CHGSTOP} .

The following table consists of die temperature value examples.

K_{DIETEMP}	T_{D}
435	50°C
422	60°C
410	70°C
397	80°C
384	90°C
372	100°C
359	110°C

Table 15: Die temperature example

6.2.7 Charger error conditions

A CHARGER error condition occurs when one of the following are present:

- Trickle charge timeout, see [t_{OUTTRICKLE}](#)
- Safety timer expires, see [t_{OUTCHARGE}](#)

After an error is detected, CHARGER is disabled. The charging error indication is activated and the charging indication is deactivated. Error conditions are cleared when **VBUS** is disconnected and reconnected again.

Errors are reported in register [BCHGERRREASON](#) on page 45 and [BCHGERRSENSOR](#) on page 45.

Host software clears errors with register [TASKCLEARCHGERR](#) on page 37 and releases the charger from the error state with register [TASKRELEASEERR](#) on page 36.

When the safety timer expires, the host must make sure it is safe to charge before resetting register [TASKCLEARSAFETYTIMER](#) on page 37.

6.2.8 Charging status (CHG) and error indication (ERR)

When CHARGER is enabled and the LEDs are configured, the LEDs indicate the charging status.

The **LED [n]** pins sink 5 mA of current when active. They are high impedance when disabled. This is suitable for driving LEDs or connecting to host GPIOs in a weak pull-up configuration. The LED anode must be connected to a voltage rail that allows forward bias. If a general purpose open drain output is needed,

the LED pins can be used with a pull-up resistor connected to a voltage rail. See [LEDDRV — LED drivers](#) on page 81 for more information.

Charging status

Charging status is available in register [BCHGCHARGESTATUS](#) on page 45.

LED drivers are configured through TWI to indicate if charging is active or charging is complete.

The charging indication turns off when charging is complete. It turns on when charging starts. The charging indication is off when CHARGER is disabled temporarily due to die temperature exceeding the configured limit.

The charging indication is off when battery temperature is below cold or above hot thresholds. No error is indicated in these cases. The charging indication is off when $V_{BUS} > V_{BUS_{OVP}}$ and no error is indicated.

Error indications

Errors are reported in register [BCHGERRREASON](#) on page 45 and [BCHGERRSENSOR](#) on page 45.

6.2.9 End-of-charge and recharge

Charging terminates automatically when the battery voltage reaches V_{TERM} and charging current is less than I_{TERM} . An interrupt is issued to the host.

Unless disabled through bit [DISABLE.RECHARGE](#), charging restarts automatically when VBAT is less than $V_{RECHARGE}$ and an interrupt is sent to the host.

6.2.10 Dynamic power-path management

CHARGER manages battery current flow to maintain V_{SYS} voltage.

The battery is isolated when V_{BUS} is connected and the battery is fully charged. Under this condition, V_{BUS} supplies V_{SYS} . When V_{BUS} is disconnected, CHARGER supplies V_{SYS} from V_{BAT} .

The system load requirements are prioritized over battery charge current when V_{BUS} is connected and the battery is charging. During charging, if the system current load exceeds $I_{BUS_{LIM}}$, the battery charge current decreases to maintain the V_{SYS} voltage. CHARGER reduces the current to maintain an internal voltage of $V_{CHDROPOUT}$ above the V_{BAT} voltage. If more current is required, CHARGER enters supplement state to provide current from the battery, up to $I_{BAT_{LIM}}$.

Note: V_{SYS} must not be supplied from an external source.

6.2.11 Battery discharge current limit

There are two selectable levels to limit battery discharge current and optimize current measurement and fuel gauge performance.

The discharge current limit is configured through registers [BCHGSETDISCHARGEMSB](#) on page 39 and [BCHGSETDISCHARGELSB](#) on page 39.

If the system load exceeds the discharge current limit, V_{SYS} voltage drops below $V_{SYS_{POF}}$ causing the device to reset, as described in [POF — Power-fail comparator](#) on page 108.

The two discharge current settings are found in the following table.

Discharge current limit selection	Purpose	Maximum battery discharge current	BCHGISETDISCHARGEMSB	BCHGISETDISCHARGELSB
Low	Increase current measurement accuracy and optimize fuel gauge performance at lower discharge currents	200 mA ¹	42	0
High	Maximum range of current measurement	1 A ¹	207	1

Table 16: Discharge current limit selection recommendations

¹ Validated through simulation.

6.2.12 Electrical specification

Symbol	Description	Min.	Typ.	Max.	Unit
V_{BAT_POR}	VBAT power-on reset release voltage		2.75		V
V_{BAT_BOR}	VBAT brownout reset trigger		2.4		V
V_{BAT_LOW}	Minimum VBAT voltage for charging		2.1		V
$V_{RECHARGE}$	Battery voltage level needed to restart charging, % of V_{TERM}		95		%
$V_{TERMACC}$	Accuracy of termination voltage	-1		+1	%
V_{TERM}	Range of termination voltage		3.5 to 3.65 4.0 to 4.45		V
V_{TERMR}	Range of termination voltage for $NTCHOT > T > NTCWARM$		3.5 to 3.65 4.0 to 4.45		V
V_{TERM_STEP}	Termination voltage step size		50		mV
I_{CHG}	Range of constant currents		32 to 800		mA
$I_{CHGSTEP}$	Charging current step		2		mA
$I_{TRICKLE}$	Trickle charging current, % of I_{CHG}		10		%
I_{COOL}	Reduced charging current, % of I_{CHG}		50		%
$V_{TRICKLE_FAST}$	Default threshold where trickle charging stops and constant current charging starts		2.9		V
$V_{CHDROPOUT}$	Charger dropout voltage		60		mV
I_{BATLIM_LOW}	Discharging battery current limit on low setting		290		mA
I_{BATLIM_HIGH}	Discharging battery current limit on high setting		1460		mA
$R_{ONCHARGER}$	Resistance between battery and V_{SYS}		160		m Ω
T_{ACC}	Temperature accuracy when using suggested NTC		2		$^{\circ}C$
$T_{CHGSTOP}$	Die temperature where charging stops (default)		110		$^{\circ}C$
$T_{CHGRESUME}$	Die temperature where charging resumes (default)		100		$^{\circ}C$
t_{REDECT}	Period between battery detection events		500		ms
$t_{OUTTRICKLE}$	Trickle charging timeout		10		min
$t_{OUTCHARGE}$	Charging timeout which covers constant current and constant voltage		7		h

Table 17: Electrical specification

6.2.13 Electrical characteristics

The following graphs show typical electrical characteristics for CHARGER.

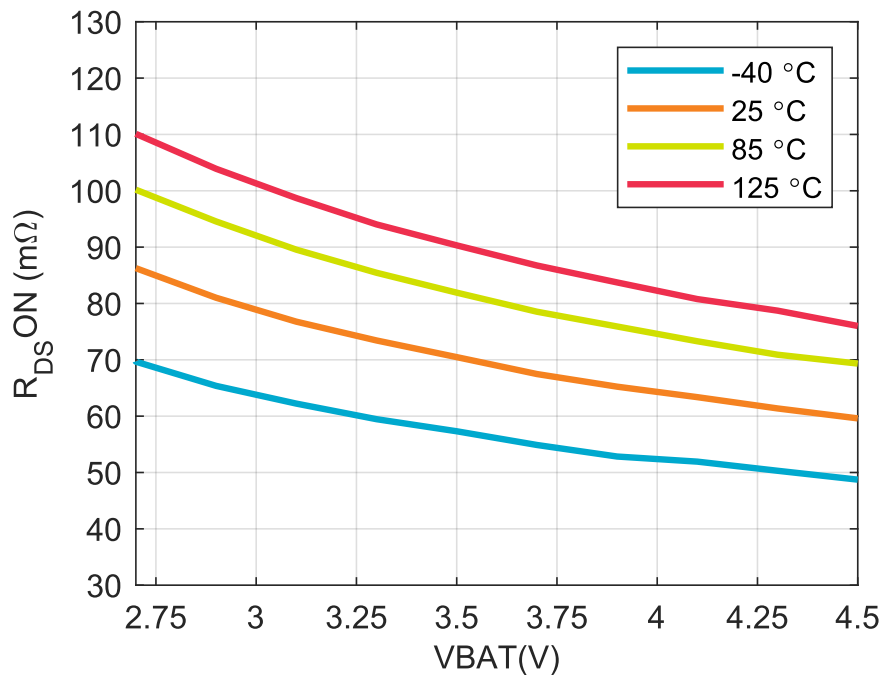

Figure 10: CHARGER RON vs. junction temperature

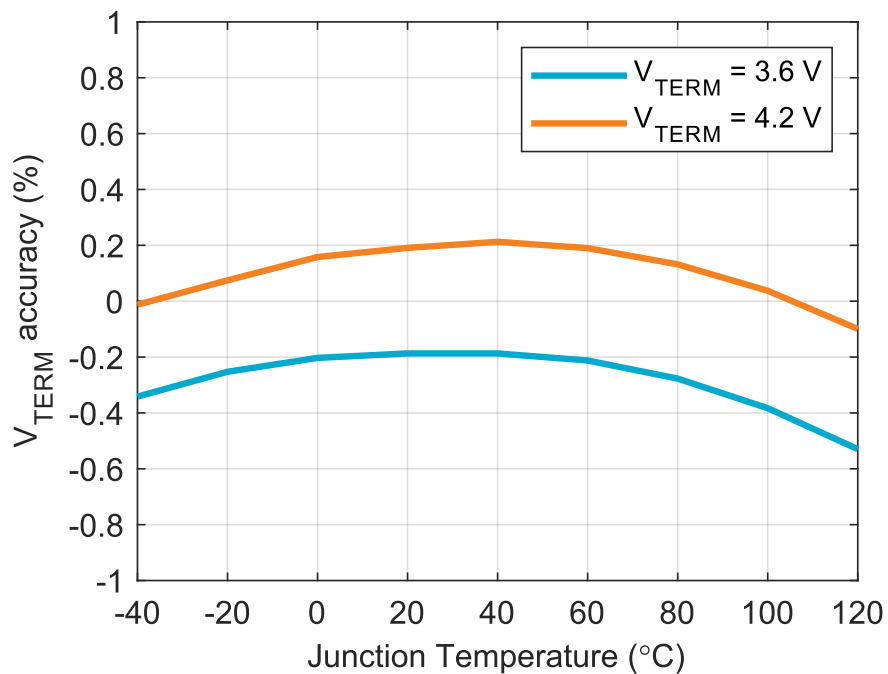

Figure 11: V_{TERM} vs. junction temperature

6.2.14 Registers

Instances

Instance	Base address	Description
BCHARGER	0x00000300	CHARGER registers BCHARGER register map

Register overview

Register	Offset	Description
TASKRELEASEERR	0x0	Release Charger from Error
TASKCLEARCHGERR	0x1	Clear error registers
TASKCLEARSAFETYTIMER	0x2	Clear safety timers
BCHGENABLESET	0x4	Charger Enable Set
BCHGENABLECLR	0x5	Charger Enable Clear
BCHGDISABLESET	0x6	Charger Disable Recharge Set
BCHGDISABLECLR	0x7	Charger Disable Recharge Clear
BCHGSETMSB	0x8	Battery Charger Current Configuration
BCHGSETLSB	0x9	Battery Charger Current Configuration
BCHGSETDISCHARGEMSB	0xA	Battery Charger Discharge Configuration
BCHGSETDISCHARGELSB	0xB	Battery Charger Discharge Configuration
BCHGVTERM	0xC	Battery Charger Termination Voltage Normal temp
BCHGVTERM	0xD	Battery Charger Termination Voltage Warm temp
BCHGVTRICKLESEL	0xE	Battery Charger Trickle Level Select
BCHGITERMSEL	0xF	Battery Charger ITERM Level Select
NTCCOLD	0x10	NTC thermistor threshold for COLD temperature region
NTCCOLDLSB	0x11	NTC thermistor threshold for COLD temperature region
NTCCOOL	0x12	NTC thermistor threshold for COOL temperature region
NTCCOOLLSB	0x13	NTC thermistor threshold for COOL temperature region
NTCWARM	0x14	NTC thermistor threshold for WARM temperature region
NTCWARMLSB	0x15	NTC thermistor threshold for WARM temperature region
NTCHOT	0x16	NTC thermistor threshold for HOT temperature region
NTCHOTLSB	0x17	NTC thermistor threshold for HOT temperature region
DIETEMPSTOP	0x18	DIE TEMP threshold for stop charging
DIETEMPSTOPLSB	0x19	DIE TEMP threshold for stop charging lsb
DIETEMPRESUME	0x1A	DIE TEMP threshold for resuming charging
DIETEMPRESUMELSB	0x1B	DIE TEMP threshold for resuming charging lsb
BCHGILIMSTATUS	0x2D	BCHARGER Ilim Status
NTCSTATUS	0x32	NTC Comparator Status
DIETEMPSTATUS	0x33	DieTemp Comparator Status
BCHGCHARGESTATUS	0x34	Charging Status
BCHGERRREASON	0x36	Charger-FSM Error. Latched error reasons. Cleared with TASKS_CLEAR_CHG_ERR
BCHGERRSENSOR	0x37	Charger-FSM Error. Latched sensor values. Cleared with TASKS_CLEAR_CHG_ERR
BCHGCONFIG	0x3C	Charger configuration

6.2.14.1 TASKRELEASEERR

Address offset: 0x0

Release Charger from Error

Bit number						7	6	5	4	3	2	1	0							
ID													A							
Reset 0x00													0	0	0	0	0	0	0	0
ID	R/W	Field	Value ID	Value	Description															
A	W	TASKRELEASEERROR			SW release from Charger Error state															
			NOEFFECT	0	No effect															
			TRIGGER	1	Trigger task															

6.2.14.2 TASKCLEARCHGERR

Address offset: 0x1

Clear error registers

Bit number						7	6	5	4	3	2	1	0						
ID													A						
Reset 0x00													0	0	0	0	0	0	0
ID	R/W	Field	Value ID	Value	Description														
A	W	TASKCLEARCHGERR			Clear registers BCHGERRREASON and BCHGERRSENSOR														
			NOEFFECT	0	No effect														
			TRIGGER	1	Trigger task														

6.2.14.3 TASKCLEARSAFETYTIMER

Address offset: 0x2

Clear safety timers

Bit number						7	6	5	4	3	2	1	0						
ID													A						
Reset 0x00													0	0	0	0	0	0	0
ID	R/W	Field	Value ID	Value	Description														
A	W	TASKCLEARSAFETYTIMER			Clear TRICKLE and CHARGE safety timers														
			NOEFFECT	0	No effect														
			TRIGGER	1	Trigger task														

6.2.14.4 BCHGENABLESET

Address offset: 0x4

Charger Enable Set

Bit number						7	6	5	4	3	2	1	0						
ID													B	A					
Reset 0x00													0	0	0	0	0	0	0
ID	R/W	Field	Value ID	Value	Description														
A	RW	ENABLECHARGING			Battery Charger Enable SET. (Read 0: Charging disabled). (Read 1: Charging enabled).														
			NOEFFECT	0	No effect														
			ENABLECHG	1	Enable Battery Charging														
B	RW	ENABLEFULLCHGCOOL			Battery Charger Enable Full Charge in Cool temp SET. (Read 0: 50% charge current value of BCHGSETMSB and BCHGSETLSB registers). (Read 1: 100% charge current value of BCHGSETMSB and BCHGSETLSB registers).														
			NOEFFECT	0	No effect														
			ENABLECOOL	1	Enable Charging of Cool battery														

6.2.14.5 BCHGENABLECLR

Address offset: 0x5

Charger Enable Clear

Bit number						7	6	5	4	3	2	1	0
ID						B A							
Reset 0x00						0	0	0	0	0	0	0	0
ID	R/W	Field	Value ID	Value	Description								
A	RW	ENABLECHARGING W1C			Battery Charger Enable CLEAR. (Read 0: Charging disabled). (Read 1: Charging enabled).								
			NOEFFECT	0	No effect								
			DISABLECHG	1	Disable Battery Charging								
B	RW	ENABLEFULLCHGCOOL W1C			Battery Charger Enable Full Charge in Cool temp CLEAR. (Read 0: 50% charge current value of BCHGSETMSB and BCHGSETLSB registers). (Read 1: 100% charge current value of BCHGSETMSB and BCHGSETLSB registers).								
			NOEFFECT	0	No effect								
			DISABLECOOL	1	Disable Charging of Cool battery								

6.2.14.6 BCHGDISABLESET

Address offset: 0x6

Charger Disable Recharge Set

Bit number						7	6	5	4	3	2	1	0
ID						B A							
Reset 0x00						0	0	0	0	0	0	0	0
ID	R/W	Field	Value ID	Value	Description								
A	RW	DISABLERECHARGE W1S			Battery Charger Disable Recharge SET. (Read 0: Recharge enabled). (Read 1: Recharge disabled).								
			NOEFFECT	0	No effect								
			DISABLERCHG	1	Disable Recharging of battery once charged								
B	RW	DISABLENTC W1S			Battery Charger ignore NTC thermistor temperature limits SET. (Read 0: NTC values enabled) (Read 1: NTC values ignored)								
			NOEFFECT	0	No effect								
			IGNORENTC	1	Charging will ignore the NTC thermistor resistor measure								

6.2.14.7 BCHGDISABLECLR

Address offset: 0x7

Charger Disable Recharge Clear

Bit number						7	6	5	4	3	2	1	0						
ID												B	A						
Reset 0x00												0	0	0	0	0	0	0	0
ID	R/W	Field	Value ID	Value	Description														
A	RW	DISABLERECHARGE W1C			Battery Charger Disable Recharge CLEAR. (Read 0: Recharge enabled). (Read 1: Recharge disabled).														
			NOEFFECT	0	No effect														
			ENABLERCHG	1	Enable Recharging of battery once charged														
B	RW	DISABLENTC W1C			Battery Charger ignore NTC thermistor temperature limits CLEAR (Read 0: NTC values enabled). (Read 1: NTC values ignored).														
			NOEFFECT	0	No effect														
			USENTC	1	Charging will use the NTC thermistor resistor measure														

6.2.14.8 BCHGISETMSB

Address offset: 0x8

Battery Charger Current Configuration

Bit number						7	6	5	4	3	2	1	0						
ID												A	A	A	A	A	A	A	
Reset 0x08												0	0	0	0	1	0	0	0
ID	R/W	Field	Value ID	Value	Description														
A	RW	BCHGISETCHARGEMSB			Battery Charger current setting (BCHG_ISET_CHARGE MSB bits [8:1]) default 32mA. See more from Charging Current chapter.														

6.2.14.9 BCHGISETLSB

Address offset: 0x9

Battery Charger Current Configuration

Bit number						7	6	5	4	3	2	1	0						
ID												A							
Reset 0x00												0	0	0	0	0	0	0	0
ID	R/W	Field	Value ID	Value	Description														
A	RW	BCHGISETCHARGELSB			Battery Charger current fine tune by 2mA (BCHG_ISET_CHARGE LSB bit [0]). See more from Charging Current chapter.														

6.2.14.10 BCHGISETDISCHARGEMSB

Address offset: 0xA

Battery Charger Discharge Configuration

Bit number						7	6	5	4	3	2	1	0						
ID												A	A	A	A	A	A	A	
Reset 0xCF												1	1	0	0	1	1	1	1
ID	R/W	Field	Value ID	Value	Description														
A	RW	BCHGISETDISCHARGEMSB			Battery Charger discharge current limiter (BCHG_ISET_DISCHARGE MSB bits [8:1]). See more from Discharge Current Limiter chapter.														

6.2.14.11 BCHGISETDISCHARGELSB

Address offset: 0xB

Battery Charger Discharge Configuration

Bit number	7 6 5 4 3 2 1 0						
ID	A						
Reset 0x01	0 0 0 0 0 0 0 1						
ID	R/W	Field	Value ID	Value	Description		
A	RW	BCHGSETDISCHARGELSB			Battery Charger discharge current limiter fine tune (BCHG_ISET_DISCHARGE LSB bit [0]). See more from Discharge Current Limiter chapter.		

6.2.14.12 BCHGVTERM

Address offset: 0xC

Battery Charger Termination Voltage Normal temp

Bit number	7 6 5 4 3 2 1 0						
ID	A A A A						
Reset 0x02	0 0 0 0 0 0 1 0						
ID	R/W	Field	Value ID	Value	Description		
A	RW	BCHGVTERMNORM			Battery Charger Normal termination voltage. Values 14-15 are equals with default value(3V60).		
			3V50	0	3.50V		
			3V55	1	3.55V		
			3V60	2	3.60V(default)		
			3V65	3	3.65V		
			4V00	4	4.00V		
			4V05	5	4.05V		
			4V10	6	4.10V		
			4V15	7	4.15V		
			4V20	8	4.20V		
			4V25	9	4.25V		
			4V30	10	4.30V		
			4V35	11	4.35V		
			4V40	12	4.40V		
			4V45	13	4.45V		

6.2.14.13 BCHGVTERM MR

Address offset: 0xD

Battery Charger Termination Voltage Warm temp

Bit number	7 6 5 4 3 2 1 0						
ID	A A A A						
Reset 0x02	0 0 0 0 0 0 1 0						
ID	R/W	Field	Value ID	Value	Description		
A	RW	BCHGVTERMREDUCED			Battery Charger Warm termination voltage. Values 14-15 are equals with default value(3V60).		
			3V50	0	3.50V		
			3V55	1	3.55V		
			3V60	2	3.60V(default)		
			3V65	3	3.65V		
			4V00	4	4.00V		
			4V05	5	4.05V		

Bit number							7	6	5	4	3	2	1	0	
ID							A				A	A	A		
Reset 0x02							0	0	0	0	0	0	0	1	0
ID	R/W	Field	Value ID	Value	Description										
			4V10	6	4.10V										
			4V15	7	4.15V										
			4V20	8	4.20V										
			4V25	9	4.25V										
			4V30	10	4.30V										
			4V35	11	4.35V										
			4V40	12	4.40V										
			4V45	13	4.45V										

6.2.14.14 BCHGVTRICKLESEL

Address offset: 0xE

Battery Charger Trickle Level Select

Bit number							7	6	5	4	3	2	1	0
ID											A			
Reset 0x00							0	0	0	0	0	0	0	0
ID	R/W	Field	Value ID	Value	Description									
A	RW	BCHGVTRICKLESEL			Battery Charger Vtrickle select									
			2V9	0	2.9V(default)									
			2V5	1	2.5V									

6.2.14.15 BCHGITERMSEL

Address offset: 0xF

Battery Charger ITERM Level Select

Bit number							7	6	5	4	3	2	1	0
ID											A			
Reset 0x00							0	0	0	0	0	0	0	0
ID	R/W	Field	Value ID	Value	Description									
A	RW	BCHGITERMSEL			Battery Charger ITERM select									
			SEL10	0	10%(default)									
			SEL20	1	20%									

6.2.14.16 NTCCOLD

Address offset: 0x10

NTC thermistor threshold for COLD temperature region

Bit number							7	6	5	4	3	2	1	0
ID							A	A	A	A	A	A	A	A
Reset 0xBB							1	0	1	1	1	0	1	1
ID	R/W	Field	Value ID	Value	Description									
A	RW	NTCCOLDLVLMSB			NTC COLD level MSB bits									

6.2.14.17 NTCCOLDLSB

Address offset: 0x11

NTC thermistor threshold for COLD temperature region

Bit number	7	6	5	4	3	2	1	0
ID							A	A
Reset 0x01	0	0	0	0	0	0	0	1
ID	R/W	Field	Value ID	Value	Description			
A	RW	NTCCOLDLVLSB			NTC COLD level LSB bits			

6.2.14.18 NTCCOOL

Address offset: 0x12

NTC thermistor threshold for COOL temperature region

Bit number	7	6	5	4	3	2	1	0
ID	A	A	A	A	A	A	A	A
Reset 0xA4	1	0	1	0	0	1	0	0
ID	R/W	Field	Value ID	Value	Description			
A	RW	NTCCOOLVLSB			NTC COOL level MSB bits			

6.2.14.19 NTCCOOLLSB

Address offset: 0x13

NTC thermistor threshold for COOL temperature region

Bit number	7	6	5	4	3	2	1	0
ID							A	A
Reset 0x02	0	0	0	0	0	0	0	1
ID	R/W	Field	Value ID	Value	Description			
A	RW	NTCCOOLLVLSB			NTC COOL level LSB bits			

6.2.14.20 NTCWARM

Address offset: 0x14

NTC thermistor threshold for WARM temperature region

Bit number	7	6	5	4	3	2	1	0
ID	A	A	A	A	A	A	A	A
Reset 0x54	0	1	0	1	0	1	0	0
ID	R/W	Field	Value ID	Value	Description			
A	RW	NTCWARMVLSB			NTC WARM level MSB bits			

6.2.14.21 NTCWARMLSB

Address offset: 0x15

NTC thermistor threshold for WARM temperature region

Bit number	7	6	5	4	3	2	1	0	
ID								A	A
Reset 0x01	0	0	0	0	0	0	0	1	
ID	R/W	Field	Value ID	Value	Description				
A	RW	NTCWARMVLVLSB			NTC WARM level LSB bits				

6.2.14.22 NTCHOT

Address offset: 0x16

NTC thermistor threshold for HOT temperature region

Bit number	7	6	5	4	3	2	1	0
ID	A	A	A	A	A	A	A	A
Reset 0x3B	0	0	1	1	1	0	1	1
ID	R/W	Field	Value ID	Value	Description			
A	RW	NTCHOTLVMSB			NTC HOT level MSB bits			

6.2.14.23 NTCHOTLSB

Address offset: 0x17

NTC thermistor threshold for HOT temperature region

Bit number	7	6	5	4	3	2	1	0	
ID								A	A
Reset 0x01	0	0	0	0	0	0	0	1	
ID	R/W	Field	Value ID	Value	Description				
A	RW	NTCHOTLVLSB			NTC HOT level LSB bits				

6.2.14.24 DIETEMPSTOP

Address offset: 0x18

DIE TEMP threshold for stop charging

Bit number	7	6	5	4	3	2	1	0
ID	A	A	A	A	A	A	A	A
Reset 0x5A	0	1	0	1	1	0	1	0
ID	R/W	Field	Value ID	Value	Description			
A	RW	DIETEMPSTOPCHG			DIE TEMP STOP charging level			

6.2.14.25 DIETEMPSTOPLSB

Address offset: 0x19

DIE TEMP threshold for stop charging lsb

Bit number	7	6	5	4	3	2	1	0	
ID								A	A
Reset 0x00	0	0	0	0	0	0	0	0	
ID	R/W	Field	Value ID	Value	Description				
A	RW	DIETEMPSTOPCHGLSB			DIE TEMP STOP charging level Lsb bits				

6.2.14.26 DIETEMPRESUME

Address offset: 0x1A

DIE TEMP threshold for resuming charging

Bit number							7	6	5	4	3	2	1	0
ID							A	A	A	A	A	A	A	A
Reset 0x5D							0	1	0	1	1	1	0	1
ID	R/W	Field	Value ID	Value	Description									
A	RW	DIETEMPRESUMECHG			DIE TEMP RESUME charging level									

6.2.14.27 DIETEMPRESUMELSB

Address offset: 0x1B

DIE TEMP threshold for resuming charging lsb

Bit number							7	6	5	4	3	2	1	0
ID													A	A
Reset 0x00							0	0	0	0	0	0	0	0
ID	R/W	Field	Value ID	Value	Description									
A	RW	DIETEMPRESUMECHGLSB			DIE TEMP RESUME charging level Lsb bits									

6.2.14.28 BCHGILIMSTATUS

Address offset: 0x2D

BCHARGER Ilim Status

Bit number							7	6	5	4	3	2	1	0
ID														A
Reset 0x00							0	0	0	0	0	0	0	0
ID	R/W	Field	Value ID	Value	Description									
A	R	BCHGILIMBATACTIVE			BCHARGER Ilimiter active									
			INACTIVE	0	Ilimbat not triggered									
			ACTIVE	1	Ilimbat triggered									

6.2.14.29 NTCSTATUS

Address offset: 0x32

NTC Comparator Status

Bit number							7	6	5	4	3	2	1	0
ID											D	C	B	A
Reset 0x00							0	0	0	0	0	0	0	0
ID	R/W	Field	Value ID	Value	Description									
A	R	NTCCOLD			NTC Cold									
B	R	NTCCOOL			NTC Cool									
C	R	NTCWARM			NTC Warm									
D	R	NTCHOT			NTC Hot									

6.2.14.30 DIETEMPSTATUS

Address offset: 0x33

DieTemp Comparator Status

Bit number		7 6 5 4 3 2 1 0						
ID								A
Reset 0x00		0 0 0 0 0 0 0 0						
ID	R/W	Field	Value ID	Value	Description			
A	R	DIETEMPHIGH			DieTemp High			
			NORMAL	0	Die below high threshold			
			HIGH	1	Die above high threshold			

6.2.14.31 BCHGCHARGESTATUS

Address offset: 0x34

Charging Status

Bit number		7 6 5 4 3 2 1 0					
ID		H G F E D C B A					
Reset 0x00		0 0 0 0 0 0 0 0					
ID	R/W	Field	Value ID	Value	Description		
A	R	BATTERYDETECTED			Battery is connected		
B	R	COMPLETED			Charging completed (Battery Full)		
C	R	TRICKLECHARGE			Trickle charge		
D	R	CONSTANTCURRENT			Constant Current charging		
E	R	CONSTANTVOLTAGE			Constant Voltage charging		
F	R	RECHARGE			Battery re-charge is needed		
G	R	DIETEMPHIGHCHGPAUSED			Charging stopped due Die Temp high.		
H	R	SUPPLEMENTACTIVE			Supplement Mode Active		

6.2.14.32 BCHGERRREASON

Address offset: 0x36

Charger-FSM Error. Latched error reasons. Cleared with TASKS_CLEAR_CHG_ERR

Bit number		7 6 5 4 3 2 1 0					
ID		G F E D C B A					
Reset 0x00		0 0 0 0 0 0 0 0					
ID	R/W	Field	Value ID	Value	Description		
A	R	NTCSENSORERROR			NTC sensor error		
B	R	VBATSENSORERROR			Vbat sensor error		
C	R	VBATLOW			VbatLow error		
D	R	VTRICKLE			Vtrickle error		
E	R	MEASTIMEOUT			Measurement timer timeout		
F	R	CHARGETIMEOUT			Charge timer timeout		
G	R	TRICKLETIMEOUT			Trickle timer timeout		

6.2.14.33 BCHGERRSENSOR

Address offset: 0x37

Charger-FSM Error. Latched sensor values. Cleared with TASKS_CLEAR_CHG_ERR

Bit number						7	6	5	4	3	2	1	0
ID						H	G	F	E	D	C	B	A
Reset 0x00						0	0	0	0	0	0	0	0
ID	R/W	Field	Value ID	Value	Description								
A	R	SENSORNTCCOLD			NTC Cold sensor value during error								
B	R	SENSORNTCCOOL			NTC Cool sensor value during error								
C	R	SENSORNTCWARM			NTC Warm sensor value during error								
D	R	SENSORNTCHOT			NTC Hot sensor value during error								
E	R	SENSORVTERM			Vterm sensor value during error								
F	R	SENSORRECHARGE			Recharge sensor value during error								
G	R	SENSORVTRICKLE			Vtrickle sensor value during error								
H	R	SENSORVBATLOW			Vbatlow sensor value during error								

6.2.14.34 BCHGCONFIG

Address offset: 0x3C

Charger configuration

Bit number						7	6	5	4	3	2	1	0
ID													A
Reset 0x00						0	0	0	0	0	0	0	0
ID	R/W	Field	Value ID	Value	Description								
A	RW	DISABLECHARGEWARM			Disable charging if battery is warm								
			ENABLED	0	Enable Charging if battery is warm								
			DISABLED	1	Disable Charging if battery is warm								

6.3 BUCK — Buck regulators

BUCK consists of two step-down buck regulators, BUCK1 and BUCK2.

BUCK has the following features:

- Ultra-high efficiency (low IQ) and low noise operation
- PWM and Hysteretic modes with automatic switching based on load
- TWI configurable for forcing PWM mode to minimize output voltage ripple
- Configurable output voltages between 1.0 V and 3.3 V

Hysteretic mode offers efficiency at lower load currents and typically operates up to half the maximum PWM current. PWM mode provides a clean supply operation due to a constant switching frequency, F_{BUCK} . This provides optimal coexistence with RF circuits. BUCK can automatically change between Hysteretic and PWM modes.

6.3.1 On/Off control

BUCK is enabled in the following ways.

- **VSET[n]** pin
- Control registers
- **GPIO[n]** pin

The **VSET1** and **VSET2** pins are enabled only at power-on. If resistor R_{VSETn} is present, BUCK is enabled with the output voltage defined by the resistor value. If the pin is grounded, BUCK is disabled. See [Default VOUT1 using an external resistor](#) on page 47 and [Default VOUT2 using an external resistor](#) on page 47.

Control registers [BUCK1ENASET](#) on page 63, [BUCK1ENACL](#) on page 63, [BUCK2ENASET](#) on page 63, and [BUCK2ENACL](#) on page 63 have enable and disable bits for each BUCK. These registers override the default BUCK state.

A GPIO can be configured in register [BUCKENCTRL](#) on page 68 to enable or disable BUCK.

If BUCK is disabled during power up, the system defaults to software control of BUCK.

6.3.2 Output voltage selection

The output voltage range for BUCK is programmable with TWI. The default output voltage selection is found on pins **VSET1** and **VSET2**, which are configured using an external resistor to **GND**. Only the output voltages shown in the tables can be selected using resistors. The **VOUT [n]** pins have two voltage configuration registers that are selectable through a GPIO pin with predefined voltage settings available.

The **VSET [n]** pins are effective only at start up. The external resistor (maximum 5% tolerance) defines the default output voltage setting as found in the following table.

Symbol	Nominal resistance	VOUT1 start up output voltage
R _{VSET1}	<100 Ω (grounded)	0 V (OFF)
	4.7 kΩ	1.0 V
	10 kΩ	1.2 V
	22 kΩ	1.5 V
	47 kΩ	1.8 V
	68 kΩ	2.0 V
	100 kΩ	2.2 V
	150 kΩ	2.5 V
	250...500 kΩ	2.7 V

Table 18: Default VOUT1 using an external resistor

Symbol	Nominal resistance	VOUT2 start up output voltage
R _{VSET2}	<100 Ω (grounded)	0 V (OFF)
	4.7 kΩ	1.8 V
	10 kΩ	2.0 V
	22 kΩ	2.2 V
	47 kΩ	2.4 V
	68 kΩ	2.5 V
	100 kΩ	2.7 V
	150 kΩ	3.0 V
	250...500 kΩ	3.3 V

Table 19: Default VOUT2 using an external resistor

Note: Do not leave **VSET [n]** floating, make sure that the **VSET [n]** pins have the correct configuration.

The output voltage range is from 1.0 V to 3.3 V in 100 mV steps and is set in the voltage configuration registers **BUCK1NORMVOUT** on page 65 and **BUCK2NORMVOUT** on page 66. Once the voltage is selected, register **BUCKSWCTRLSEL** on page 70 must be written to for the values to take effect.

Registers **BUCK1VOUTSTATUS** on page 70 and **BUCK2VOUTSTATUS** on page 70 indicate the status or current voltage setting.

A GPIO can be configured to select between two voltage levels. The output voltage for retention mode is configured in registers **BUCK1RETVOUT** on page 65 and **BUCK2RETVOUT** on page 67. Select a GPIO to control retention voltage in register **BUCKVRETCTRL** on page 68.

6.3.3 BUCK mode selection

BUCK operates in Automatic mode by default. When in Automatic mode, BUCK selects Hysteretic mode for low load currents, and PWM mode for high load currents.

In PWM mode, BUCK provides a clean supply operation due to constant switching frequency and lower voltage ripple for optimal coexistence with RF circuits.

Forced pulse width modulation (PWM) is set by the following:

- Control register bits in **BUCK[n]PWMSET**
- **GPIO [n]** pins in register **BUCKPWMCTRL** on page 69 overriding the register setting for one or both BUCKs

Hysteretic mode can be forced in register **BUCKCTRL0** on page 70 for each BUCK. This setting is not available using GPIO.

6.3.4 Active output capacitor discharge

When the converter is disabled, active discharge can be enabled or disabled in register **BUCKCTRL0** on page 70 using **R_{DISCH}** from the output capacitors. The default setting is disabled.

Capacitor discharge is forced when there is a power cycle reset. See figure **Power cycle** on page 113.

6.3.5 Component selection

Recommended values for the inductor are shown in the following table.

Parameter	Value	Unit
Nominal inductance	2.2	μH
Inductor tolerance	≤ 20	%
DC resistance (DCR)	≤ 400	mΩ
Saturation current (I_{sat})	> 350	mA
Rated current (I_{max})	> 200	mA

Table 20: Recommended inductor specifications

Parameter	Value	Unit
Nominal Capacitance	10	μF
Capacitor tolerance	≤ 20	%
Rated voltage	≥ 10	V
ESR	≤ 50	$\text{m}\Omega$

Table 21: Recommended capacitor specifications

6.3.6 Electrical specification

Symbol	Description	Min.	Typ.	Max.	Unit
$V_{\text{OUT}[n]_{\text{ACC}}}$	Output voltage accuracy	-5		+5	%
$V_{\text{SYS}_{\text{MIN}}}$	Minimum VSYS voltage for enabling BUCK (dependent on POF setting)		2.7		V
I_{OUT}	Maximum BUCK current to maintain performance			200	mA
$V_{\text{DROP}_{\text{OUT}}}$	Drop-out voltage 1 mA load		100		mV
R_{DISCH}	Active output capacitor discharge resistance		2		$\text{k}\Omega$
I_{PWMTHRES}	Load current threshold from Hysteretic to PWM mode (mode = AUTO)		90		mA
$I_{\text{HYSTTHRES}}$	Load current threshold from PWM to Hysteretic mode (mode = AUTO)		40		mA
$V_{\text{OUT}_{\text{RIPPLE}_{\text{PWM}}}}$	VOUT ripple in PWM mode $I_{\text{OUT}} = 200 \text{ mA}$		5		mVpp
$V_{\text{OUT}_{\text{RIPPLE}_{\text{HYST}}}}$	VOUT ripple in Hysteretic mode		50		mVpp
EFF_{BUCK}	Efficiency in PWM mode $V_{\text{SYS}} = 3.8 \text{ V}$ $V_{\text{OUT}} = 3.3 \text{ V}$ $I_{\text{OUT}} = 200 \text{ mA}$		93		%
f_{BUCK}	Switching frequency in PWM mode		3.6		MHz
t_{STRT}	Start-up time $V_{\text{OUT}} = 3.3 \text{ V}$ $C = 10 \mu\text{F}$		1.2		ms
t_{PWMMODE}	Transition time Hysteretic to PWM mode Automatic (and via TWI or GPIO)		90 (55)		μs

Symbol	Description	Min.	Typ.	Max.	Unit
t_{HYST}	Transition time Hysteretic to PWM mode Automatic (and through TWI or GPIO)		35 (25)		μs

Table 22: BUCK electrical specification

6.3.7 Electrical characteristics

The following graphs show typical electrical characteristics for BUCK.

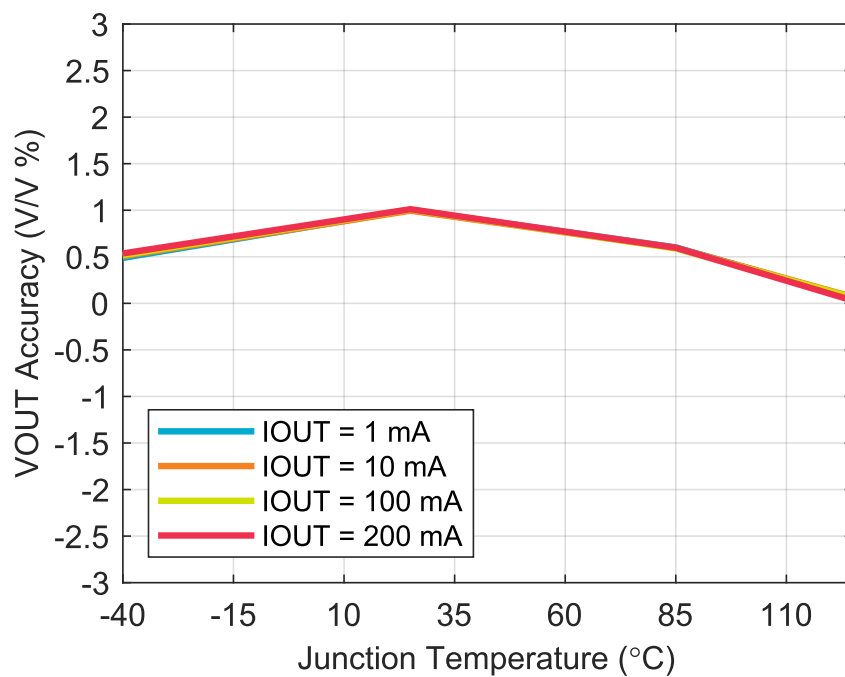

Figure 12: VBAT = 4.35 V; VOUT = 3.0 V vs. junction temperature

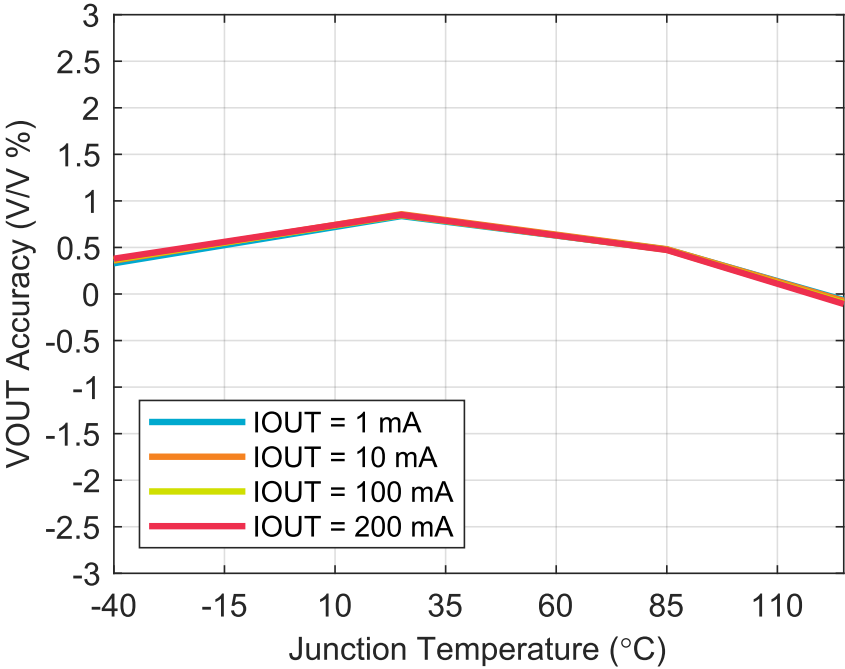

Figure 13: VBAT = 3.8: VOUT = 3.0 V vs. junction temperature

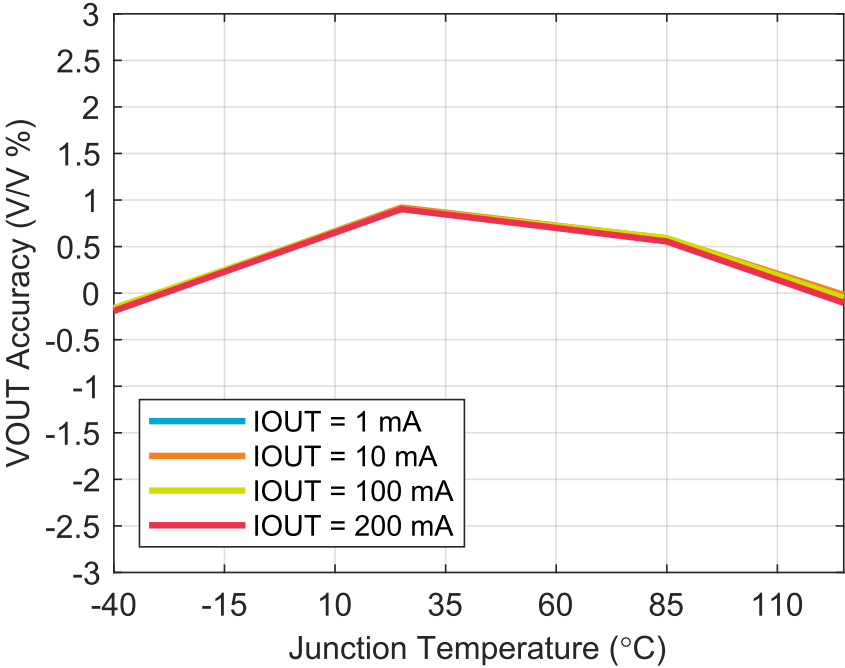

Figure 14: VBAT = 4.35 V: VOUT = 1.8 vs. junction temperature

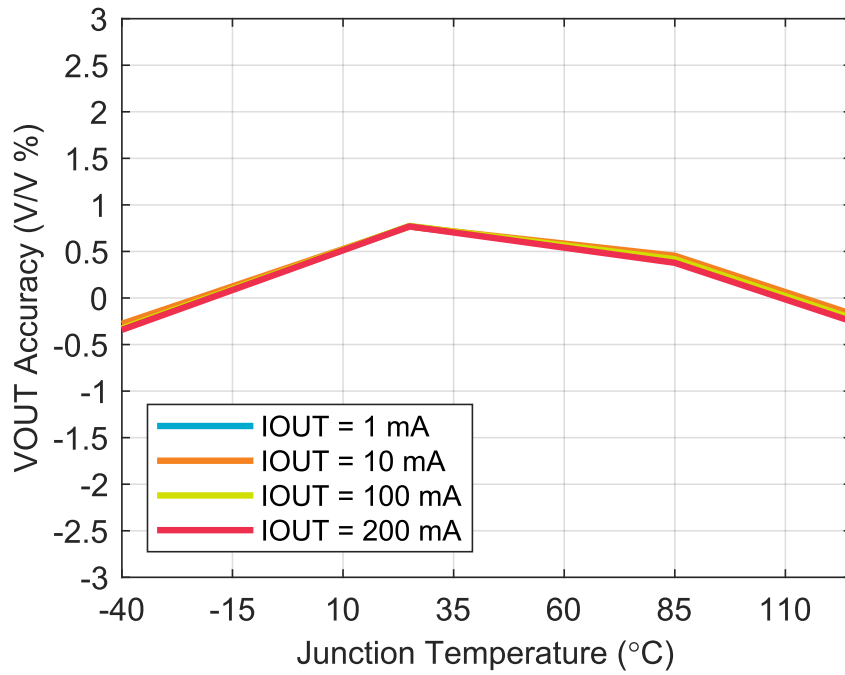

Figure 15: VBAT = 3.8 V: VOUT = 1.8 vs. junction temperature

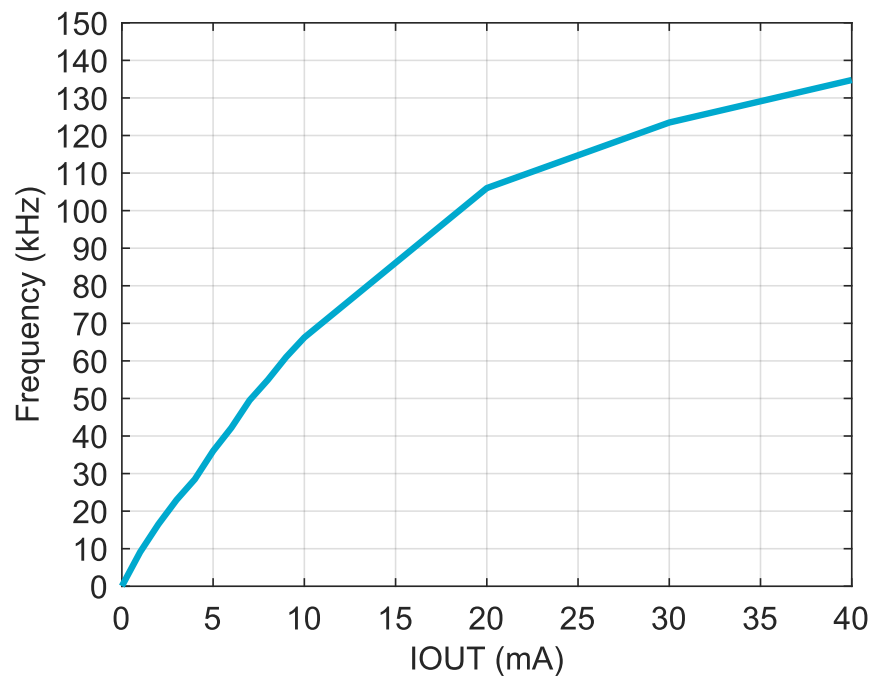

Figure 16: VBAT = 3.8 V: VOUT = 2.0 V: PFM frequency vs. current

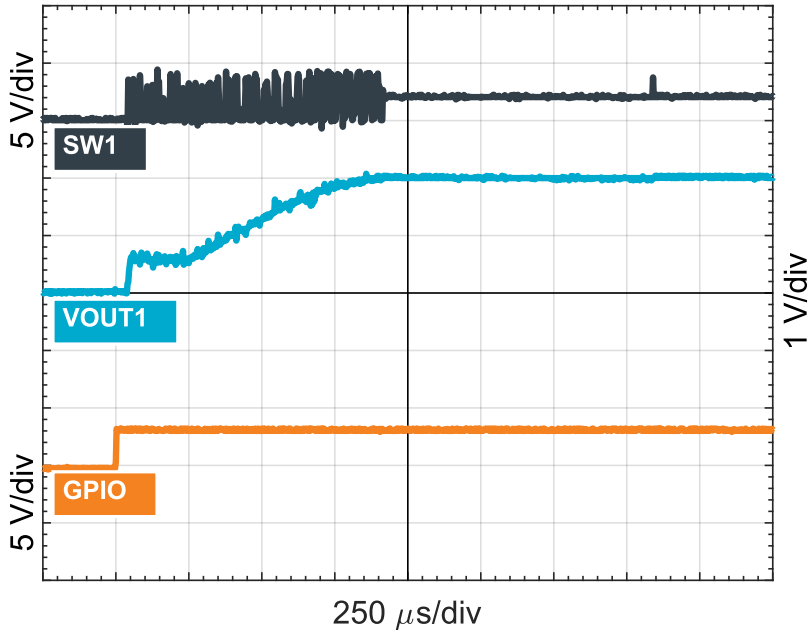

Figure 17: VBAT = 3.8 V: VOUT = 2.0 V: GPIO BUCK start

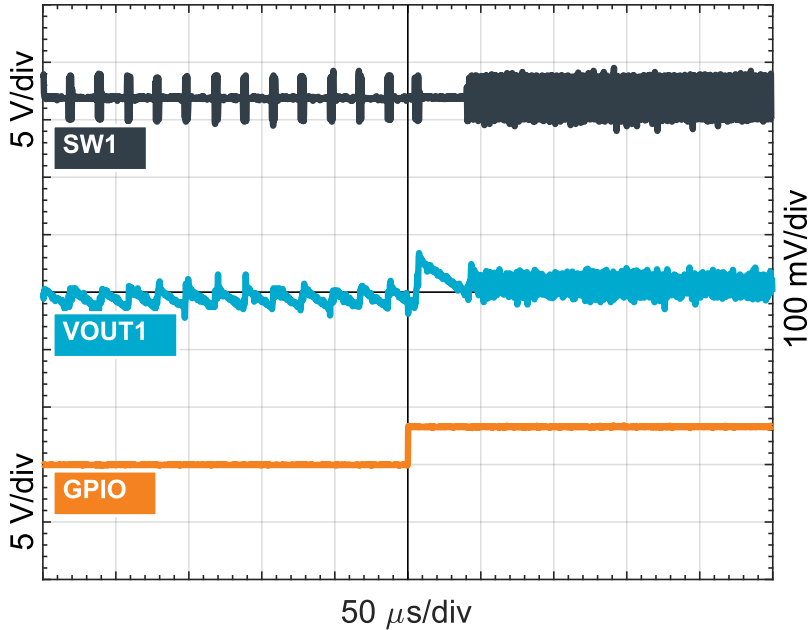

Figure 18: VBAT = 3.8 V: VOUT = 2.0 V: GPIO PWM mode selection

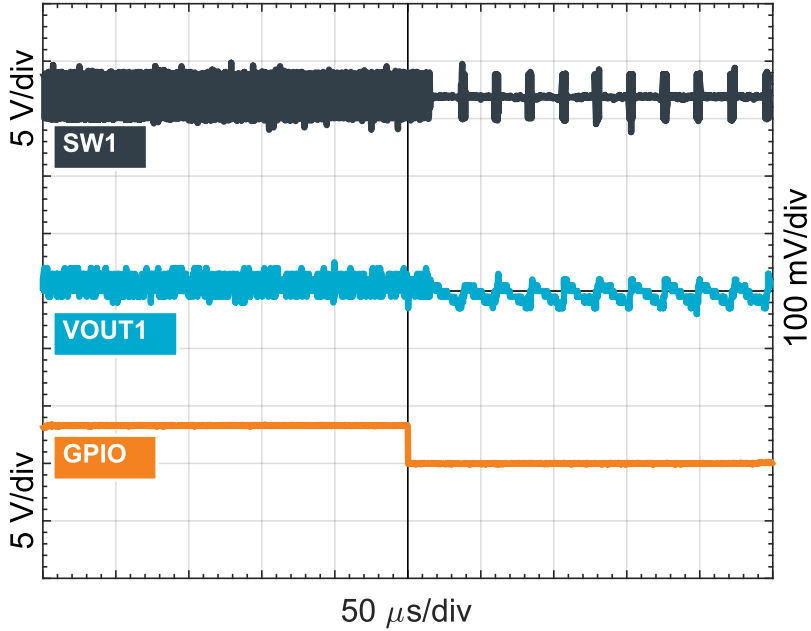

Figure 19: VBAT = 3.8 V: VOUT = 2.0 V: GPIO PFM mode selection

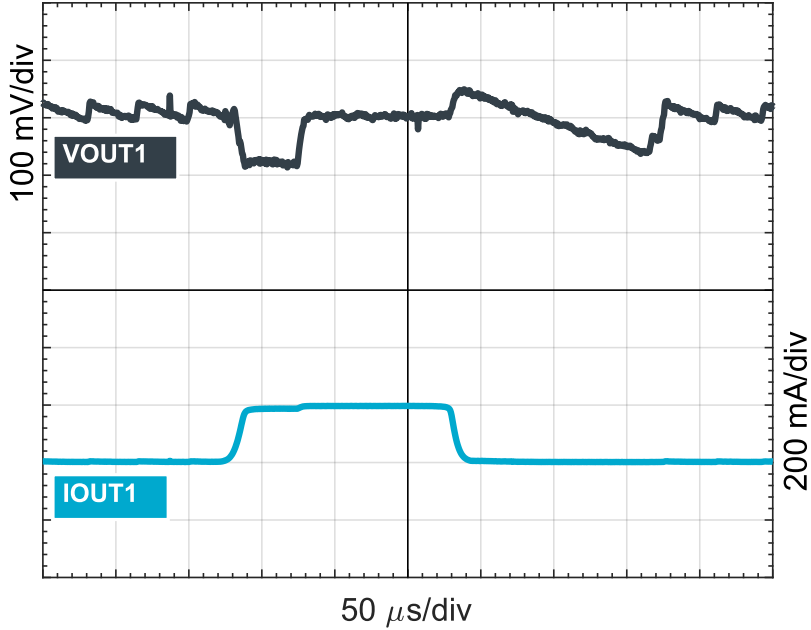

Figure 20: VBAT = 3.8 V: VOUT = 2.0 V: Auto mode extreme load transient

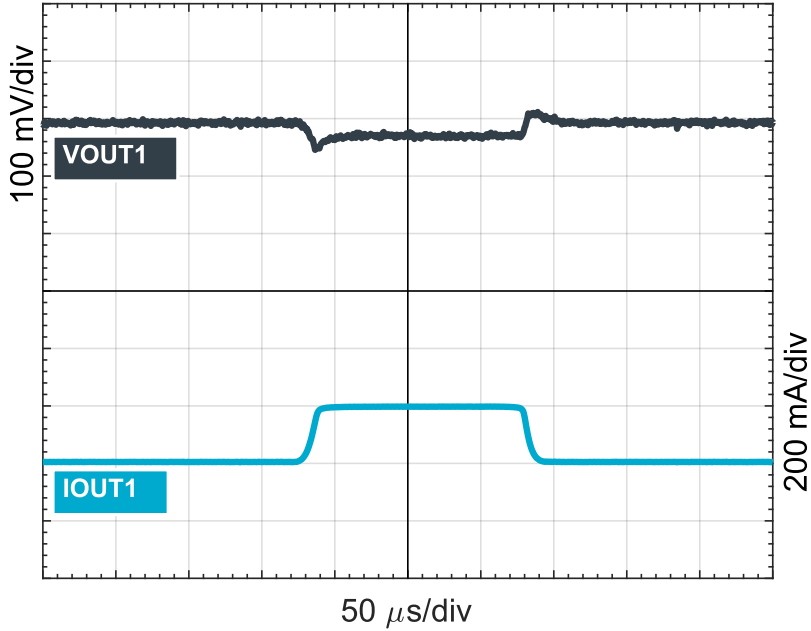

Figure 21: VBAT = 3.8 V: VOUT = 2.0 V: PWM mode extreme load transient

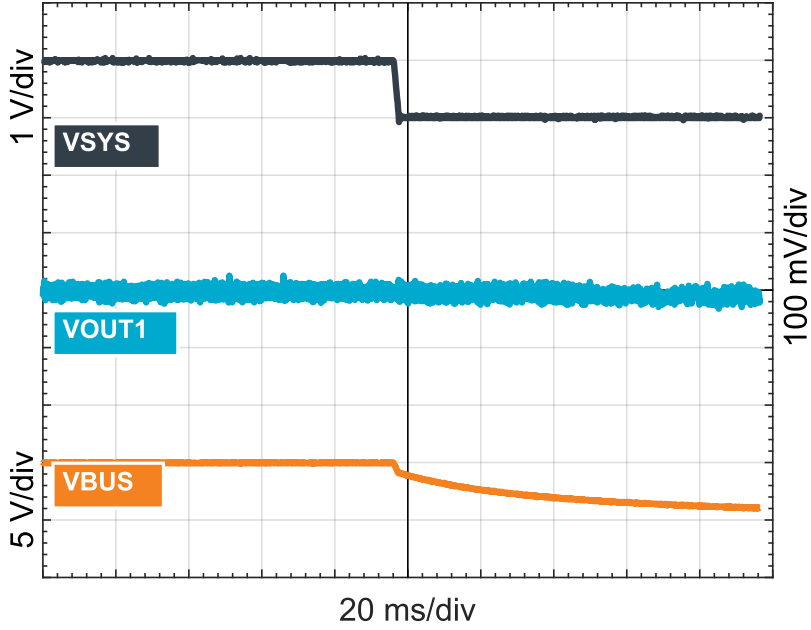

Figure 22: VBAT = 3.8 V: VOUT = 2.0 V: VBUS detach

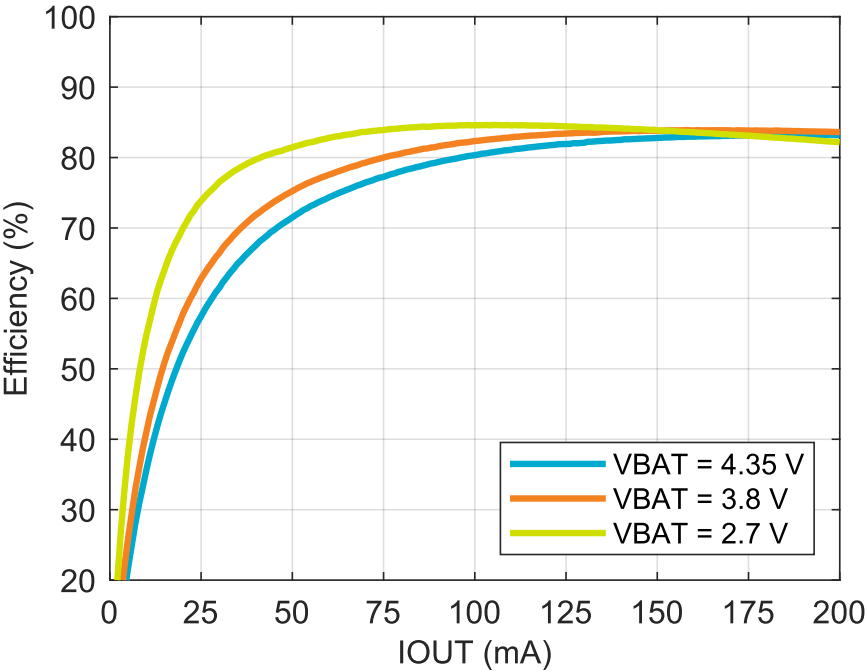

Figure 23: VOUT = 1.0 V: PWM Efficiency

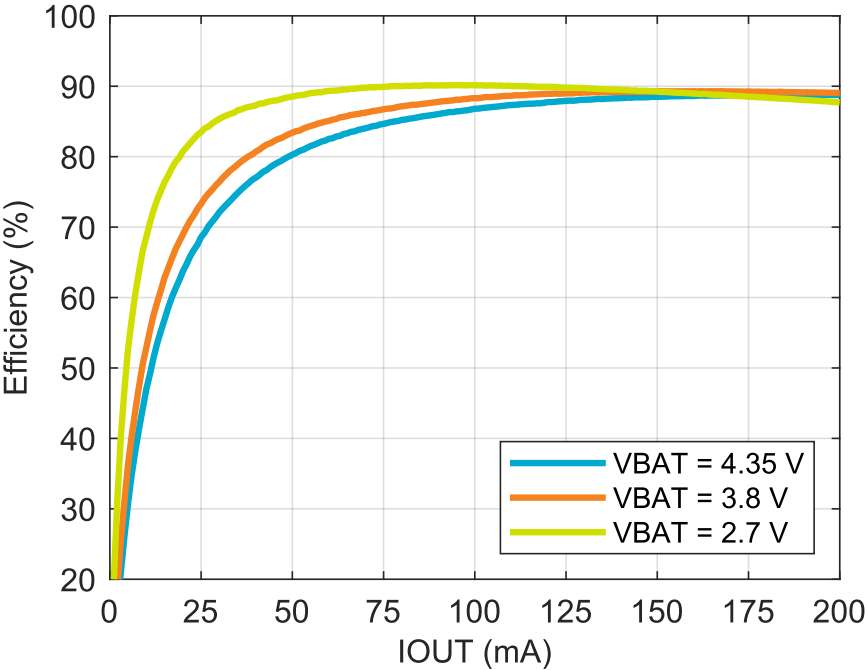

Figure 24: VOUT = 1.8 V: PWM efficiency

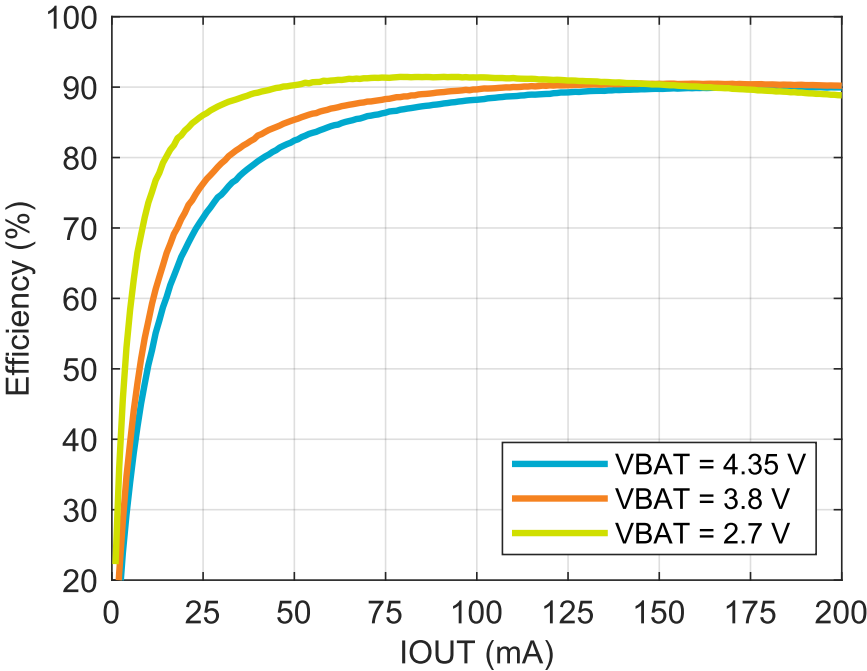

Figure 25: VOUT = 2.1 V: PWM efficiency

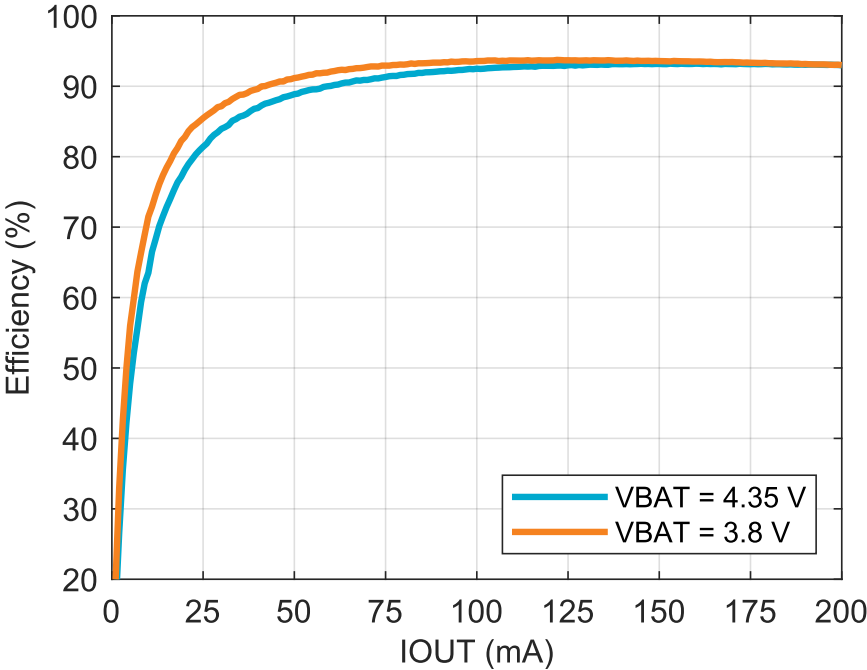

Figure 26: VOUT = 3.3 V: PWM efficiency

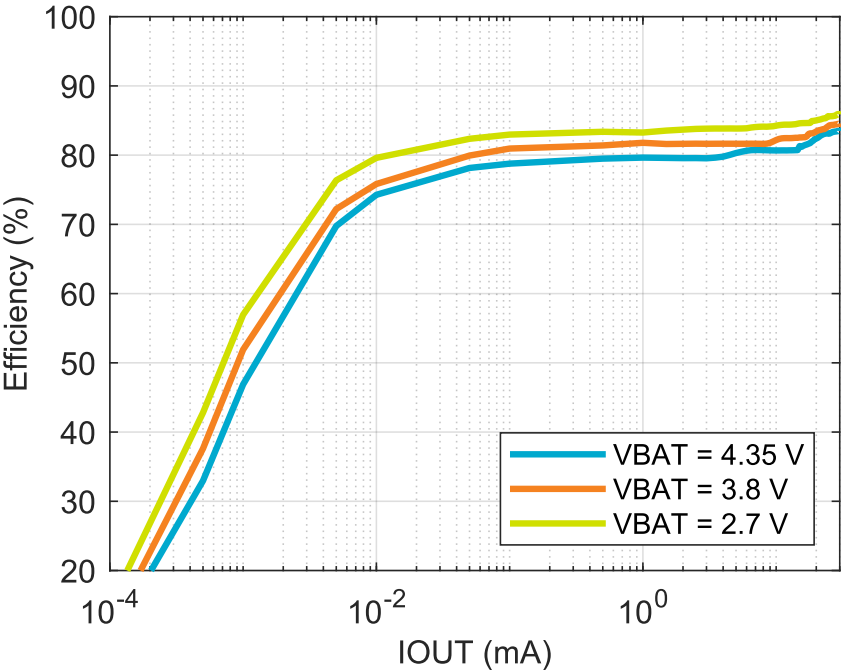

Figure 27: VOUT = 1.0 V: Hysteretic efficiency

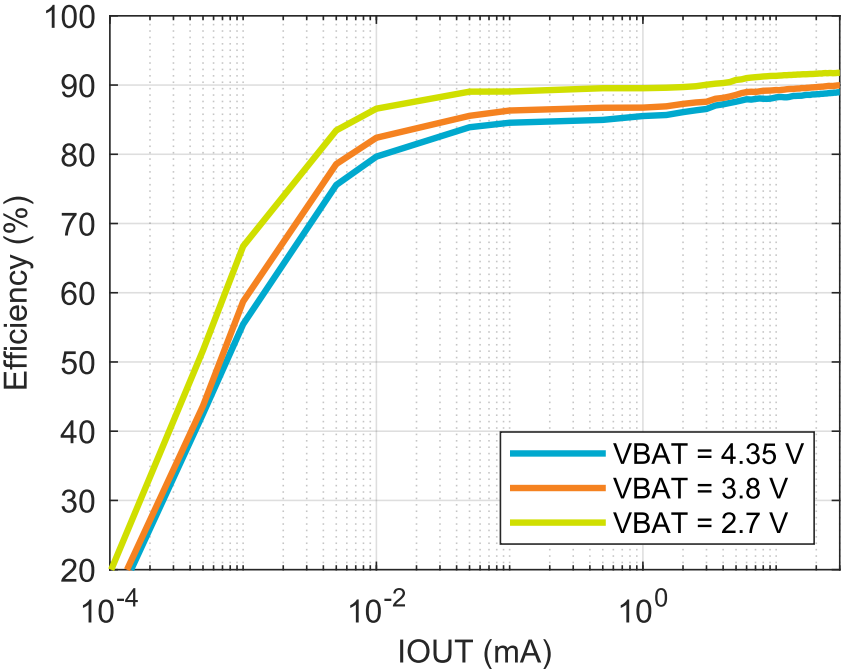

Figure 28: VOUT = 1.8 V: Hysteretic efficiency

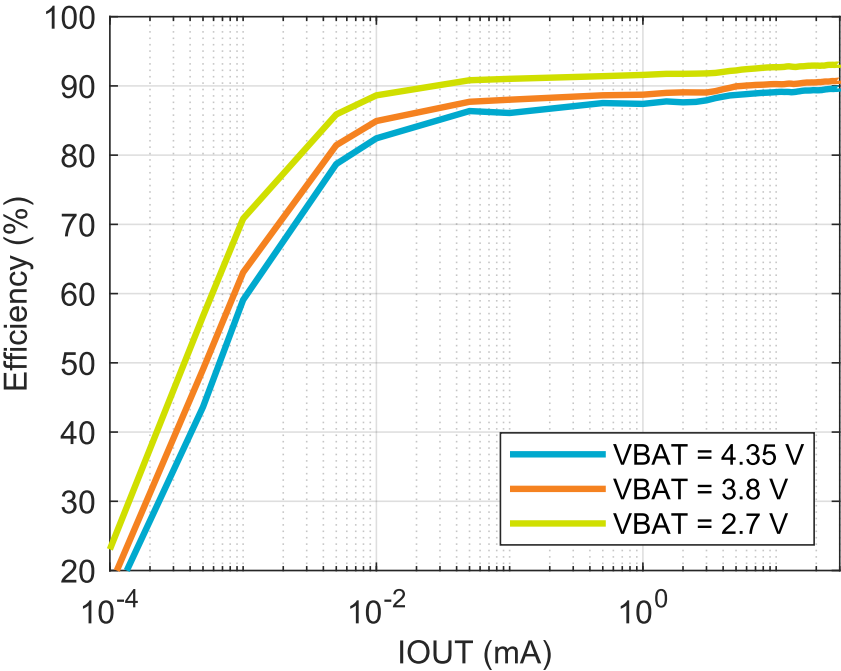

Figure 29: VOUT = 2.1 V: Hysteretic efficiency

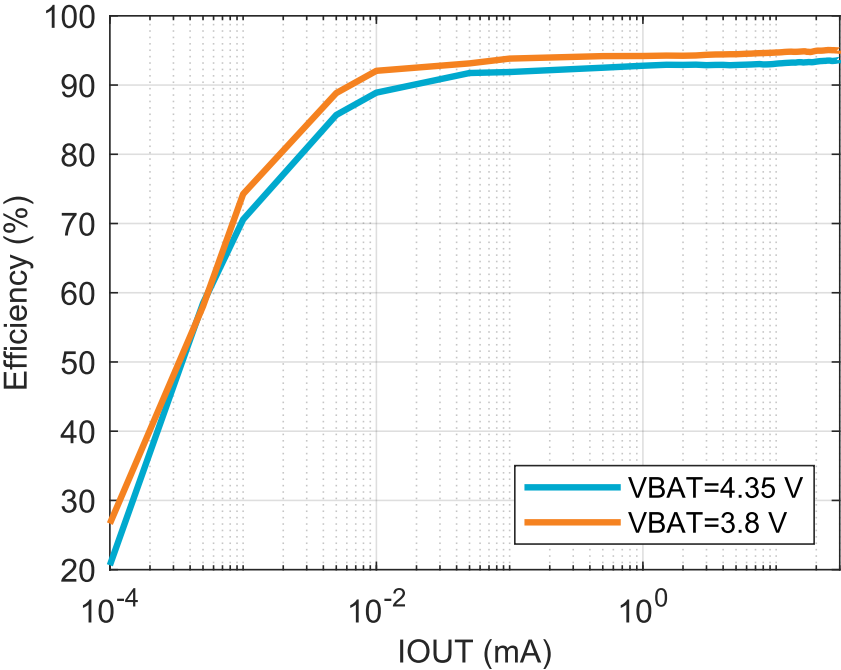

Figure 30: VOUT = 3.3 V: Hysteretic efficiency

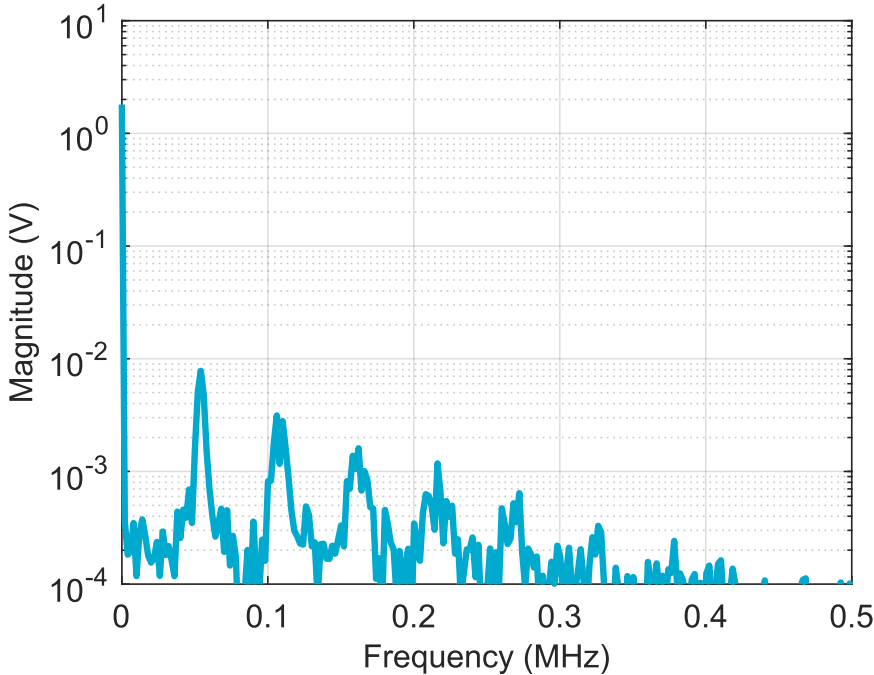

Figure 31: VOUT = 1.8 V: FFT 10 mA: PFM

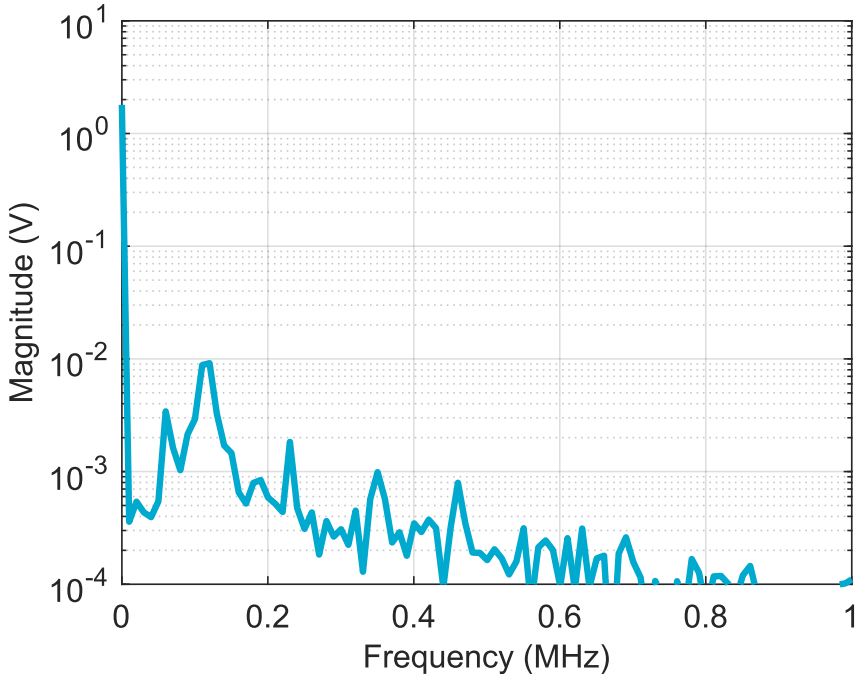

Figure 32: VOUT = 1.8 V: FFT 50 mA: PFM

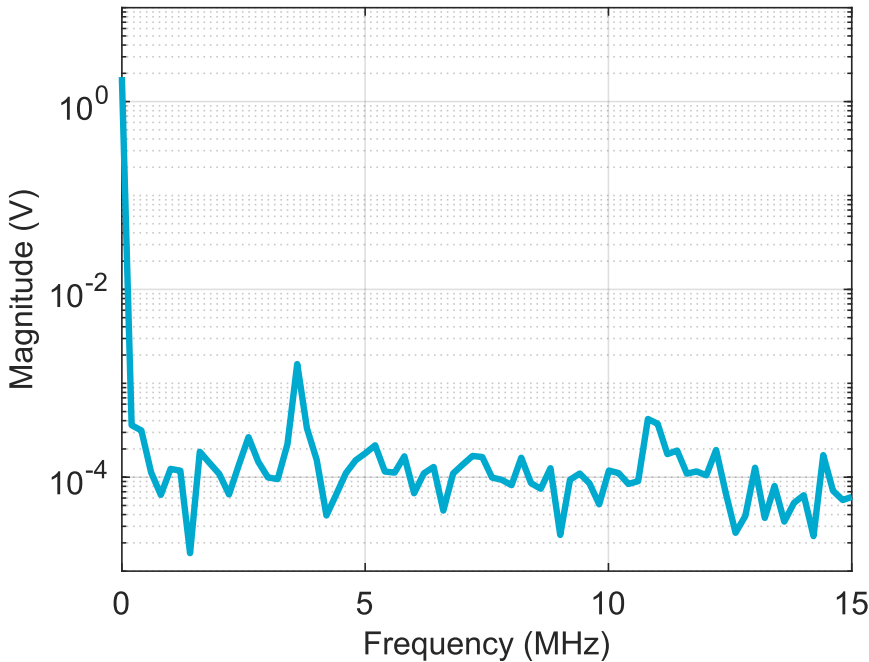

Figure 33: $V_{OUT} = 1.8\text{ V}$; FFT 100 mA; PWM: clock = 3.6 MHz

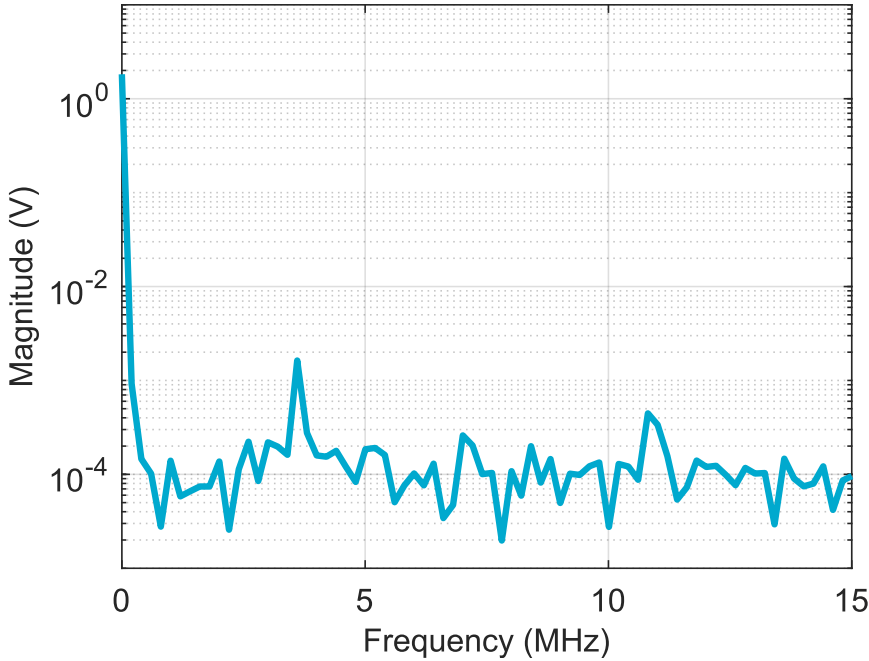

Figure 34: $V_{OUT} = 1.8\text{ V}$; FFT 200 mA; PWM: clock = 3.6 MHz

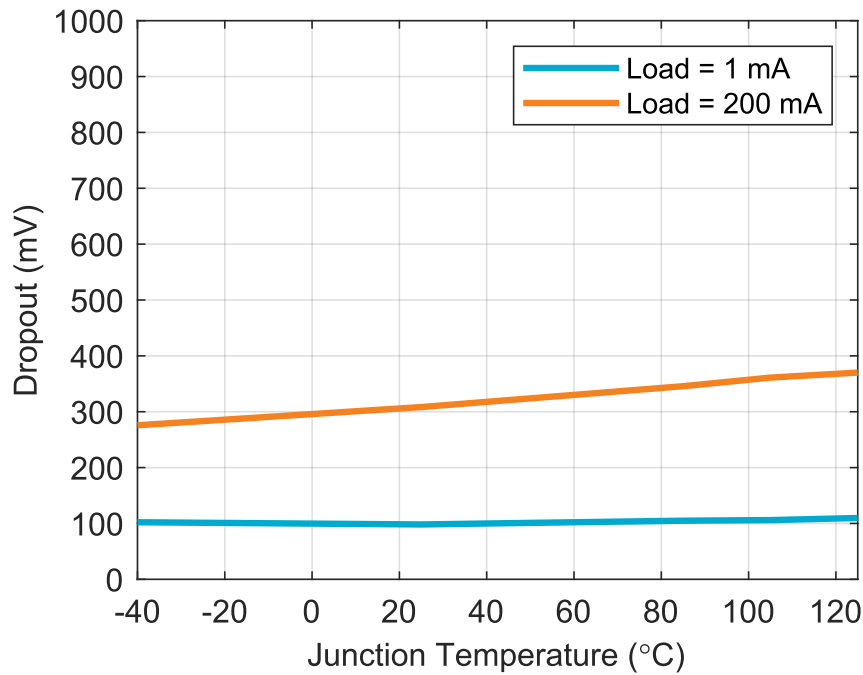

Figure 35: BUCK dropout

6.3.8 Registers

Instances

Instance	Base address	Description
BUCK	0x00000400	BUCK registers BUCK register

Register overview

Register	Offset	Description
BUCK1ENASET	0x0	BUCK1 Enable pulse
BUCK1ENACLAR	0x1	BUCK1 Disable pulse
BUCK2ENASET	0x2	BUCK2 Enable pulse
BUCK2ENACLAR	0x3	BUCK2 Disable pulse
BUCK1PWMSET	0x4	BUCK1 PWM mode enable pulse
BUCK1PWMCLR	0x5	BUCK1 PWM mode disable pulse
BUCK2PWMSET	0x6	BUCK2 PWM mode enable pulse
BUCK2PWMCLR	0x7	BUCK2 PWM mode disable pulse
BUCK1NORMVOUT	0x8	BUCK1 Output voltage Normal mode
BUCK1RETVOUT	0x9	BUCK1 Output voltage Retention mode
BUCK2NORMVOUT	0xA	BUCK2 Output voltage Normal mode
BUCK2RETVOUT	0xB	BUCK2 Output voltage Retention mode
BUCKENCTRL	0xC	BUCK Enable GPIO Select
BUCKVRECTRL	0xD	BUCK Retention Voltage select
BUCKPWMCTRL	0xE	BUCK Forced PWM mode GPIO select
BUCKSWCTRLSEL	0xF	BUCK Software Control select
BUCK1VOUTSTATUS	0x10	BUCK1 VOUT Status register. Lets software read the Vout value in case its driven by the FSM.
BUCK2VOUTSTATUS	0x11	BUCK2 VOUT Status register. Lets software read the Vout value in case its driven by the FSM.

Register	Offset	Description
BUCKCTRL0	0x15	BUCK Auto PFM to PWM Control select
BUCKSTATUS	0x34	BUCK status register

6.3.8.1 BUCK1ENASET

Address offset: 0x0

BUCK1 Enable pulse

Bit number	7	6	5	4	3	2	1	0	
ID									A
Reset 0x00	0	0	0	0	0	0	0	0	
ID	R/W	Field	Value ID	Value	Description				
A	W	TASKBUCK1ENASET			Request to enable BUCK1				
			NOEFFECT	0	no effect				
			SET	1	BUCK1 Enable request set				

6.3.8.2 BUCK1ENACLRL

Address offset: 0x1

BUCK1 Disable pulse

Bit number	7	6	5	4	3	2	1	0	
ID									A
Reset 0x00	0	0	0	0	0	0	0	0	
ID	R/W	Field	Value ID	Value	Description				
A	W	TASKBUCK1ENACLRL			Request to disable BUCK1				
			NOEFFECT	0	no effect				
			SET	1	BUCK1 Enable request clr				

6.3.8.3 BUCK2ENASET

Address offset: 0x2

BUCK2 Enable pulse

Bit number	7	6	5	4	3	2	1	0	
ID									A
Reset 0x00	0	0	0	0	0	0	0	0	
ID	R/W	Field	Value ID	Value	Description				
A	W	TASKBUCK2ENASET			Request to enable BUCK2				
			NOEFFECT	0	no effect				
			SET	1	BUCK2 Enable request set				

6.3.8.4 BUCK2ENACLRL

Address offset: 0x3

BUCK2 Disable pulse

Bit number						7	6	5	4	3	2	1	0							
ID													A							
Reset 0x00													0	0	0	0	0	0	0	0
ID	R/W	Field	Value ID	Value	Description															
A	W	TASKBUCK2ENACL			Request to enable BUCK2															
			NOEFFECT	0	no effect															
			SET	1	BUCK2 Enable request clr															

6.3.8.5 BUCK1PWMSET

Address offset: 0x4

BUCK1 PWM mode enable pulse

Bit number						7	6	5	4	3	2	1	0							
ID													A							
Reset 0x00													0	0	0	0	0	0	0	0
ID	R/W	Field	Value ID	Value	Description															
A	W	TASKBUCK1PWMSET			request for BUCK1 to enter forced PWM mode															
			NOEFFECT	0	no effect															
			SET	1	BUCK1 Forced PWM request															

6.3.8.6 BUCK1PWMCLR

Address offset: 0x5

BUCK1 PWM mode disable pulse

Bit number						7	6	5	4	3	2	1	0							
ID													A							
Reset 0x00													0	0	0	0	0	0	0	0
ID	R/W	Field	Value ID	Value	Description															
A	W	TASKBUCK1PWMCLR			request for BUCK1 to leave forced PWM mode and return to Auto mode															
			NOEFFECT	0	no effect															
			SET	1	BUCK1 Auto mode request															

6.3.8.7 BUCK2PWMSET

Address offset: 0x6

BUCK2 PWM mode enable pulse

Bit number						7	6	5	4	3	2	1	0							
ID													A							
Reset 0x00													0	0	0	0	0	0	0	0
ID	R/W	Field	Value ID	Value	Description															
A	W	TASKBUCK2PWMSET			request for BUCK2 to enter forced PWM mode															
			NOEFFECT	0	no effect															
			SET	1	BUCK2 Forced PWM request															

6.3.8.8 BUCK2PWMCLR

Address offset: 0x7

BUCK2 PWM mode disable pulse

Bit number						7	6	5	4	3	2	1	0							
ID													A							
Reset 0x00													0	0	0	0	0	0	0	0
ID	R/W	Field	Value ID	Value	Description															
A	W	TASKBUCK2PWMCLR			request for BUCK2 to leave forced PWM mode and return to Auto mode															
			NOEFFECT	0	no effect															
			SET	1	BUCK2 Auto mode request															

6.3.8.9 BUCK1NORMVOUT

Address offset: 0x8

BUCK1 Output voltage Normal mode

Bit number						7	6	5	4	3	2	1	0							
ID													A	A	A	A	A			
Reset 0x02													0	0	0	0	0	0	1	0
ID	R/W	Field	Value ID	Value	Description															
A	RW	BUCK1NORMVOUT			BUCK1 Output voltage Normal mode															
			1V	0	1V															
			1V1	1	1.1V															
			1V2	2	1.2V(Default)															
			1V3	3	1.3V															
			1V4	4	1.4V															
			1V5	5	1.5V															
			1V6	6	1.6V															
			1V7	7	1.7V															
			1V8	8	1.8V															
			1V9	9	1.9V															
			2V0	10	2V															
			2V1	11	2.1V															
			2V2	12	2.2V															
			2V3	13	2.3V															
			2V4	14	2.4V															
			2V5	15	2.5V															
			2V6	16	2.6V															
			2V7	17	2.7V															
			2V8	18	2.8V															
			2V9	19	2.9V															
			3V0	20	3V															
			3V1	21	3.1V															
			3V2	22	3.2V															
			3V3	23	3.3V															
			3V30	24	3.3V															

6.3.8.10 BUCK1RETVOUT

Address offset: 0x9

BUCK1 Output voltage Retention mode

Bit number						7	6	5	4	3	2	1	0
ID						A	A	A	A	A			
Reset 0x02						0	0	0	0	0	0	1	0
ID	R/W	Field	Value ID	Value	Description								
A	RW	BUCK1RETVOUT			BUCK1 Output voltage Retention mode								
			1V	0	1V								
			1V1	1	1.1V								
			1V2	2	1.2V(Default)								
			1V3	3	1.3V								
			1V4	4	1.4V								
			1V5	5	1.5V								
			1V6	6	1.6V								
			1V7	7	1.7V								
			1V8	8	1.8V								
			1V9	9	1.9V								
			2V0	10	2V								
			2V1	11	2.1V								
			2V2	12	2.2V								
			2V3	13	2.3V								
			2V4	14	2.4V								
			2V5	15	2.5V								
			2V6	16	2.6V								
			2V7	17	2.7V								
			2V8	18	2.8V								
			2V9	19	2.9V								
			3V0	20	3V								
			3V1	21	3.1V								
			3V2	22	3.2V								
			3V3	23	3.3V								
			3V30	24	3.3V								

6.3.8.11 BUCK2NORMVOUT

Address offset: 0xA

BUCK2 Output voltage Normal mode

Bit number						7	6	5	4	3	2	1	0
ID						A	A	A	A	A			
Reset 0x08						0	0	0	0	1	0	0	0
ID	R/W	Field	Value ID	Value	Description								
A	RW	BUCK2NORMVOUT			BUCK2 Output voltage Normal mode								
			1V	0	1V								
			1V1	1	1.1V								
			1V2	2	1.2V								
			1V3	3	1.3V								
			1V4	4	1.4V								
			1V5	5	1.5V								
			1V6	6	1.6V								
			1V7	7	1.7V								
			1V8	8	1.8V(Default)								
			1V9	9	1.9V								
			2V0	10	2V								
			2V1	11	2.1V								

Bit number						7	6	5	4	3	2	1	0
ID						A A A A A							
Reset 0x08						0	0	0	0	1	0	0	0
ID	R/W	Field	Value ID	Value	Description								
			2V2	12	2.2V								
			2V3	13	2.3V								
			2V4	14	2.4V								
			2V5	15	2.5V								
			2V6	16	2.6V								
			2V7	17	2.7V								
			2V8	18	2.8V								
			2V9	19	2.9V								
			3V0	20	3V								
			3V1	21	3.1V								
			3V2	22	3.2V								
			3V3	23	3.3V								
			3V30	24	3.3V								

6.3.8.12 BUCK2RETVOUT

Address offset: 0xB

BUCK2 Output voltage Retention mode

Bit number						7	6	5	4	3	2	1	0
ID						A A A A A							
Reset 0x08						0	0	0	0	1	0	0	0
ID	R/W	Field	Value ID	Value	Description								
A	RW	BUCK2RETVOUT			BUCK2 Output voltage Retention mode								
			1V	0	1V								
			1V1	1	1.1V								
			1V2	2	1.2V								
			1V3	3	1.3V								
			1V4	4	1.4V								
			1V5	5	1.5V								
			1V6	6	1.6V								
			1V7	7	1.7V								
			1V8	8	1.8V(Default)								
			1V9	9	1.9V								
			2V0	10	2V								
			2V1	11	2.1V								
			2V2	12	2.2V								
			2V3	13	2.3V								
			2V4	14	2.4V								
			2V5	15	2.5V								
			2V6	16	2.6V								
			2V7	17	2.7V								
			2V8	18	2.8V								
			2V9	19	2.9V								
			3V0	20	3V								
			3V1	21	3.1V								
			3V2	22	3.2V								
			3V3	23	3.3V								
			3V30	24	3.3V								

6.3.8.13 BUCKENCTRL

Address offset: 0xC

BUCK Enable GPIO Select

Bit number						7	6	5	4	3	2	1	0
ID						D	C	B	B	A	A	A	A
Reset 0x00						0	0	0	0	0	0	0	0
ID	R/W	Field	Value ID	Value	Description								
A	RW	BUCK1ENGPISSEL			Select which GPIO controls BUCK1_enable								
			NOTUSED	0	Not used								
			GPIO0	1	GPIO_0 selected								
			GPIO1	2	GPIO_1 selected								
			GPIO2	3	GPIO_2 selected								
			GPIO3	4	GPIO_3 selected								
			GPIO4	5	GPIO_4 selected								
			NOTUSED1	6	no GPIO selected								
			NOTUSED2	7	no GPIO selected								
B	RW	BUCK2ENGPISSEL			Select which GPIO controls BUCK2_enable								
			NOTUSED1	0	Not used								
			GPIO0	1	GPIO_0 selected								
			GPIO1	2	GPIO_1 selected								
			GPIO2	3	GPIO_2 selected								
			GPIO3	4	GPIO_3 selected								
			GPIO4	5	GPIO_4 selected								
			NOTUSED3	6	no GPIO selected								
			NOTUSED4	7	no GPIO selected								
C	RW	BUCK1ENGPININV			Invert the sense of the selected GPIO								
			NORMAL	0	not Inverted								
			INVERTED	1	Inverted								
D	RW	BUCK2ENGPININV			Invert the sense of the selected GPIO								
			NORMAL	0	not Inverted								
			INVERTED	1	Inverted								

6.3.8.14 BUCKVRETCTRL

Address offset: 0xD

BUCK Retention Voltage select

Bit number						7	6	5	4	3	2	1	0
ID						D	C	B	B	A	A	A	A
Reset 0x00						0	0	0	0	0	0	0	0
ID	R/W	Field	Value ID	Value	Description								
A	RW	BUCK1VRETGPISSEL			Select which GPIO controls BUCK1_retention voltage sel								
			NOTUSED	0	Not used								
			GPIO0	1	GPIO_0 selected								
			GPIO1	2	GPIO_1 selected								
			GPIO2	3	GPIO_2 selected								
			GPIO3	4	GPIO_3 selected								
			GPIO4	5	GPIO_4 selected								
			NOTUSED2	6	Not used								
			NOTUSED1	7	Not used								
B	RW	BUCK2VRETGPISSEL			Select which GPIO controls BUCK2_retention voltage sel								

Bit number						7	6	5	4	3	2	1	0
ID						D	C	B	B	A	A	A	A
Reset 0x00						0	0	0	0	0	0	0	0
ID	R/W	Field	Value ID	Value	Description								
			NOTUSED	0	Not used								
			GPIO0	1	GPI_0 selected								
			GPIO1	2	GPI_1 selected								
			GPIO2	3	GPI_2 selected								
			GPIO3	4	GPI_3 selected								
			GPIO4	5	GPI_4 selected								
			NOTUSED2	6	Not used								
			NOTUSED1	7	Not used								
C	RW	BUCK1VRETPGIINV			Invert the sense of the selected GPIO								
			NORMAL	0	not inverted								
			INVERTED	1	Inverted								
D	RW	BUCK2VRETPGIINV			Invert the sense of the selected GPIO								
			NORMAL	0	not inverted								
			INVERTED	1	Inverted								

6.3.8.15 BUCKPWMCTRL

Address offset: 0xE

BUCK Forced PWM mode GPIO select

Bit number						7	6	5	4	3	2	1	0
ID						D	C	B	B	A	A	A	A
Reset 0x00						0	0	0	0	0	0	0	0
ID	R/W	Field	Value ID	Value	Description								
A	RW	BUCK1PWMGPISEL			Select which GPI controls BUCK1 force PWM								
			NOTUSED1	0	Not used								
			GPIO0	1	GPI_0 selected								
			GPIO1	2	GPI_1 selected								
			GPIO2	3	GPI_2 selected								
			GPIO3	4	GPI_3 selected								
			GPIO4	5	GPI_4 selected								
			NOTUSED	6	Not used								
			NOTUSED2	7	Not used								
B	RW	BUCK2PWMGPISEL			Select which GPI controls BUCK2 force PWM								
			NOTUSED1	0	Not used								
			GPIO0	1	GPI_0 selected								
			GPIO1	2	GPI_1 selected								
			GPIO2	3	GPI_2 selected								
			GPIO3	4	GPI_3 selected								
			GPIO4	5	GPI_4 selected								
			NOTUSED	6	Not used								
			NOTUSED2	7	Not used								
C	RW	BUCK1PWMGPIINV			Invert the sense of the selected GPIO								
			NORMAL	0	not inverted								
			INVERTED	1	Inverted								
D	RW	BUCK2PWMGPIINV			Invert the sense of the selected GPIO								
			NORMAL	0	not inverted								
			INVERTED	1	Inverted								

6.3.8.16 BUCKSWCTRLSEL

Address offset: 0xF

BUCK Software Control select

Bit number		7 6 5 4 3 2 1 0						
ID								B A
Reset 0x00		0 0 0 0 0 0 0 0						
ID	R/W	Field	Value ID	Value	Description			
A	RW	BUCK1SWCTRLSEL	VSETANDSWCTRL	0	Allow VSET pins to set VOUT			
			SWCTRL	1	Allow SW to override VSET pin			
B	RW	BUCK2SWCTRLSEL	VSETANDSWCTRL	0	Allow VSET pins to set VOUT			
			SWCTRL	1	Allow SW to override VSET pin			

6.3.8.17 BUCK1VOUTSTATUS

Address offset: 0x10

BUCK1 VOUT Status register. Lets software read the Vout value in case its driven by the FSM.

Bit number		7 6 5 4 3 2 1 0						
ID								A A A A A
Reset 0x00		0 0 0 0 0 0 0 0						
ID	R/W	Field	Value ID	Value	Description			
A	R	BUCK1VOUTSTATUS			BUCK1VoutStatus			

6.3.8.18 BUCK2VOUTSTATUS

Address offset: 0x11

BUCK2 VOUT Status register. Lets software read the Vout value in case its driven by the FSM.

Bit number		7 6 5 4 3 2 1 0						
ID								A A A A A
Reset 0x00		0 0 0 0 0 0 0 0						
ID	R/W	Field	Value ID	Value	Description			
A	R	BUCK2VOUTSTATUS			BUCK2VoutStatus			

6.3.8.19 BUCKCTRL0

Address offset: 0x15

BUCK Auto PFM to PWM Control select

Bit number		7 6 5 4 3 2 1 0						
ID								D C B A
Reset 0x00		0 0 0 0 0 0 0 0						
ID	R/W	Field	Value ID	Value	Description			
A	RW	BUCK1AUTOCTRLSEL	AUTO	0	Select Auto switching between PFM and PWM			
			PFM	1	Select PFM mode only			
B	RW	BUCK2AUTOCTRLSEL						

Bit number						7	6	5	4	3	2	1	0
ID						D				C	B	A	
Reset 0x00						0	0	0	0	0	0	0	0
ID	R/W	Field	Value ID	Value	Description								
			AUTO	0	Select Auto switching between PFM and PWM								
			PFM	1	Select PFM mode only								
C	RW	BUCK1ENPULLDOWN			BUCK1_EN_PULLDOWN								
			LOW	0	BUCK1 Pull Down Disabled								
			HIGH	1	BUCK1 Pull Down Enabled								
D	RW	BUCK2ENPULLDOWN			BUCK2_EN_PULLDOWN								
			LOW	0	BUCK2 Pull Down Disabled								
			HIGH	1	BUCK2 Pull Down Enabled								

6.3.8.20 BUCKSTATUS

Address offset: 0x34

BUCK status register

Bit number						7	6	5	4	3	2	1	0
ID						F	E	D	C	B	A	A	
Reset 0x00						0	0	0	0	0	0	0	0
ID	R/W	Field	Value ID	Value	Description								
A	R	BUCK1MODE			BUCK1Mode								
			AUTOMODE	0	Auto mode								
			PFMMODE	1	PFM mode								
			PWMMODE	2	Force PWM mode								
B	R	BUCK1PWRGOOD			BUCK1PwrGood								
			BUCKDISABLED	0	BUCK powered off								
			BUCKPOWERED	1	BUCK powered on								
C	R	BUCK1PWMOK			BUCK1PwmOk								
			PWMMODEDISABLED0		PWM mode disabled								
			PWMMODEENABLED1		PWM mode enabled								
D	R	BUCK2MODE			BUCK2Mode								
			AUTOMODE	0	Auto mode								
			PFMMODE	1	PFM mode								
			PWMMODE	2	Force PWM mode								
E	R	BUCK2PWRGOOD			BUCK2PwrGood								
			BUCKDISABLED	0	BUCK powered off								
			BUCKPOWERED	1	BUCK powered on								
F	R	BUCK2PWMOK			BUCK2PwmOk								
			PWMMODEDISABLED0		PWM mode disabled								
			PWMMODEENABLED1		PWM mode enabled								

6.4 LOADSW/LDO — Load switches/LDO regulators

Two load switches are available for use as switches or LDOs. They have dedicated input pins where voltage cannot exceed V_{SYS} . The input voltage can be equal to V_{OUT1} , V_{OUT2} , or any voltage up to the V_{SYS} voltage.

The mode is selected using registers `LDSW[n]LDOSEL`.

Load switch

The load switches are OFF by default and can be controlled through a control register or GPIO pin using the following bits.

- Control register bits for each load switch:
 - [TASK.LDSW\[n\]SET](#)
 - [TASK.LDSW\[n\]CLR](#)
- GPIO[n], once configured by host software:
 - [LDSW\[n\]GPISEL](#)

When a GPIO is configured as a load switch, it uses edges. When the GPIO toggles from LOW to HIGH, the switch turns ON (conducting). When the GPIO toggles from HIGH to LOW, the switch turns OFF.

Each load switch can be assigned to a separate GPIO, or a single GPIO can control both switches.

Soft start is enabled by default. This ensures that the current to **LSOUT [n]** is limited for T_{SS} . Once soft start is complete, there will be no current limiting provided by the load switch. Only current limiting from the power source connected to **LSin [n]** will provide limiting.

The soft start current limit can be set in register [LDSWCONFIG](#) on page 78. A pull-down resistor R_{LSPD} on the **LSOUT [n]** pin is enabled in a register bit. See register [LDSWCONFIG](#) on page 78.

LDO mode

The load switches can be separately configured as LDOs. The output voltage is configurable in registers [LDSW\[n\]VOUTSEL](#).

The LDO can be supplied from **VOUT1**, **VOUT2** or **VSYS**, but must comply with VIN_{LDO} .

6.4.1 Electrical specification

Symbol	Description	Min.	Typ.	Max.	Unit
$RDSON_{LS}$	Switch on-resistance $LS_{IN} = 3.3\text{ V}$		200		$m\Omega$
I_{LS}	Current $LS_{OUT} \geq 1.2\text{ V}$			100	mA
t_{SS}	Soft start time Soft start current limit = 25 mA, 10 μF , 0 V to 5 V		1.8		ms
R_{LSPD}	Pull-down resistor (active discharge) at LS_{OUT}		2		$k\Omega$
VIN_{LS}	Input voltage range	1.0		VSYS	V

Table 23: LOADSW electrical specification

Symbol	Description	Min.	Typ.	Max.	Unit
I_{OUT_LDO}	Output current $V_{OUT} > 1.2\text{ V}$			50	mA
I_{OUT_LDO}	Output current $V_{OUT} < 1.2\text{ V}$			10	mA
V_{IN_LDO}	Input voltage range	2.6		V_{SYS}	V
V_{OUT_LDO}	Minimum setting output voltage		1.0		V
V_{OUT_LDO}	Maximum setting output voltage		3.3		V
V_{OUT_LDO} step	Output voltage step size		100		mV

Table 24: LDO electrical specification

6.4.2 Electrical characteristics

The following graphs show typical electrical characteristics for LOADSW.

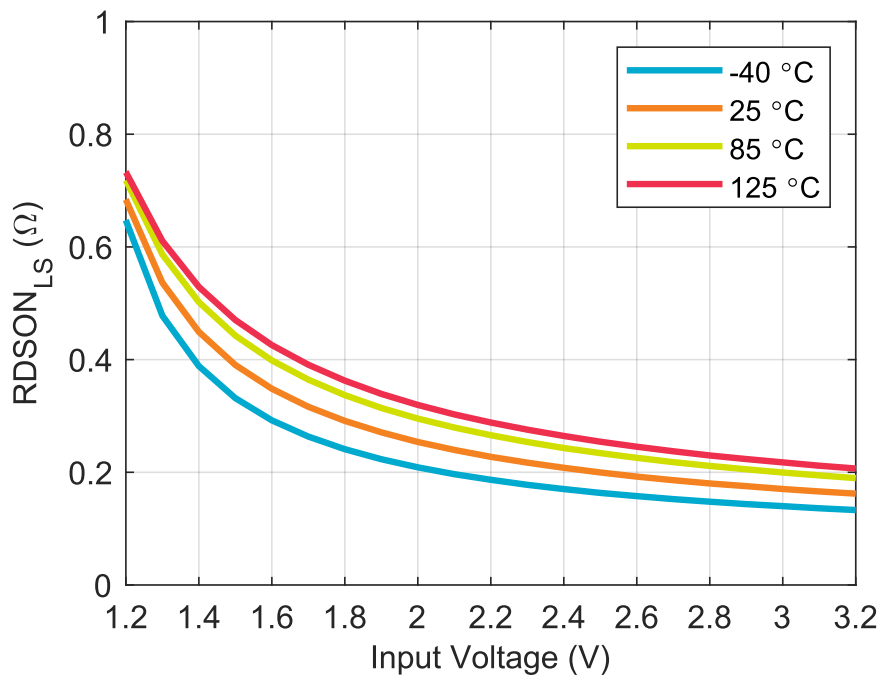
Figure 36: LOADSW $R_{DS_{ON}}$ vs. junction temperature

The following graphs show electrical characteristics for LDO.

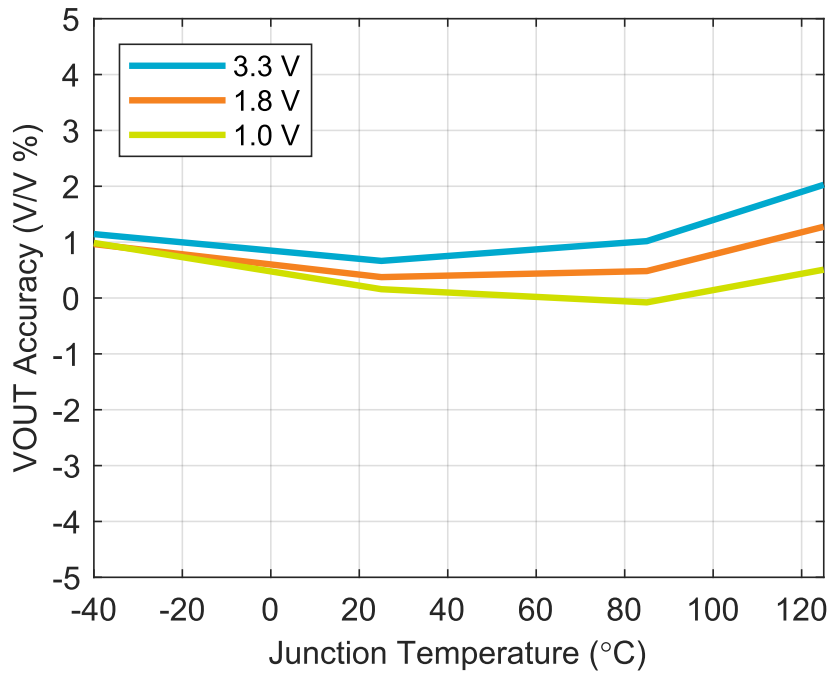

Figure 37: LDO voltage accuracy vs. junction temperature (VBUS = 5.5 V)

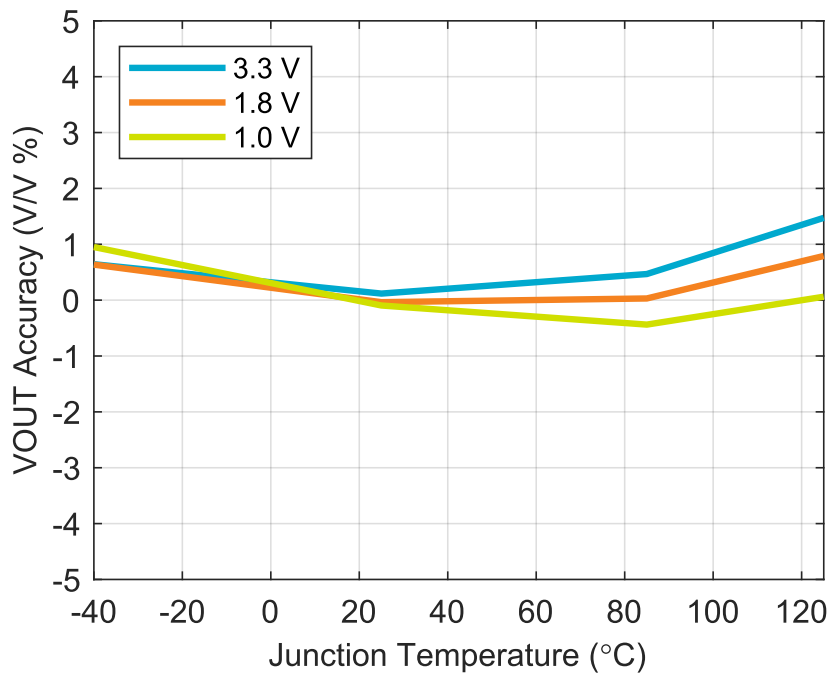

Figure 38: LDO voltage accuracy vs. junction temperature (VBAT = 3.8 V)

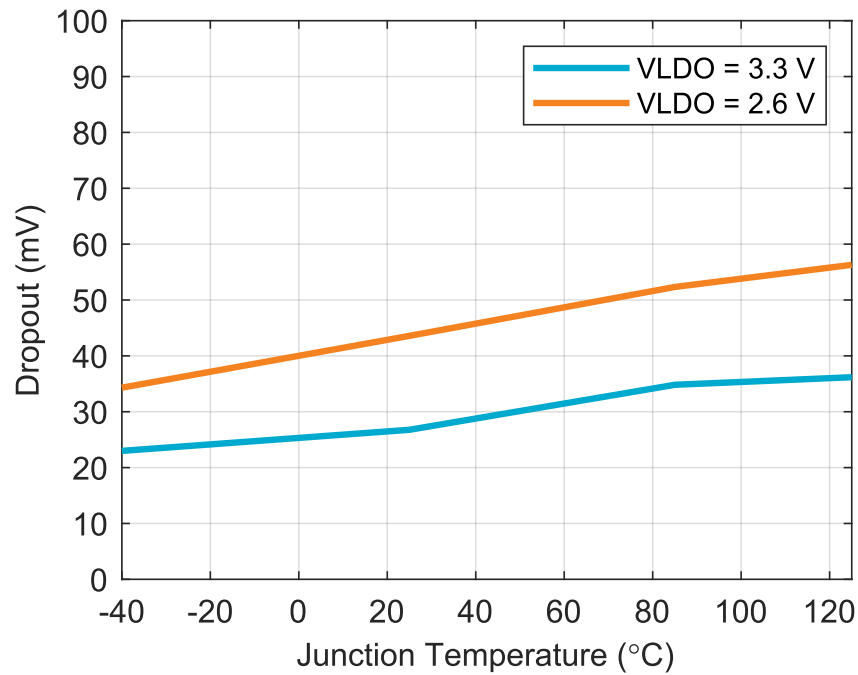

Figure 39: LDO dropout vs. junction temperature

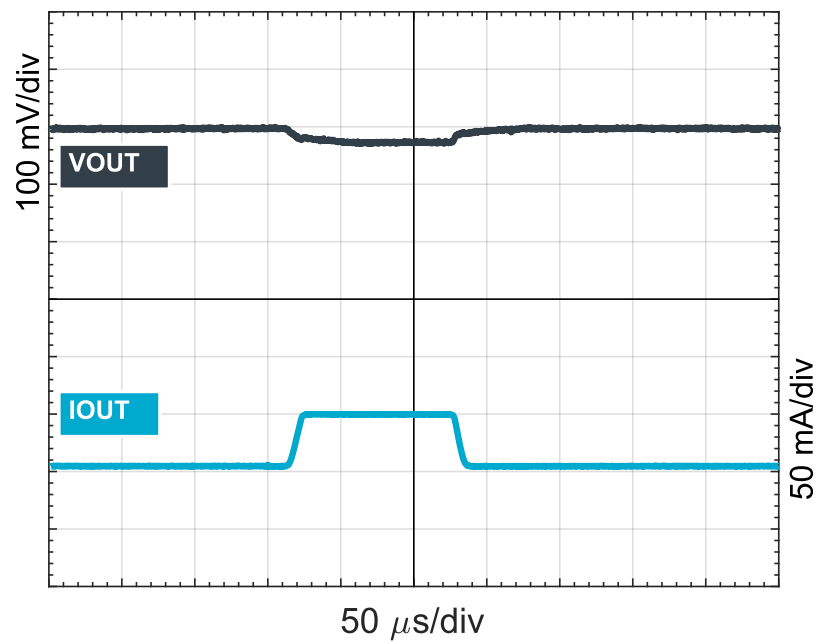

Figure 40: VINLDO = 3.8 V; VOUTLDO = 1.8 V; LDO load transient

6.4.3 Registers

Instances

Instance	Base address	Description
LDSW	0x00000800	LOADSW registers LDSW register map

Register overview

Register	Offset	Description
TASKLDSW1SET	0x0	Enable LDSW1
TASKLDSW1CLR	0x1	Disable LDSW1
TASKLDSW2SET	0x2	Enable LDSW2
TASKLDSW2CLR	0x3	Disable LDSW2
LDSWSTATUS	0x4	Load Switch Status
LDSW1GPISEL	0x5	Load Switch1 GPIO Control Select
LDSW2GPISEL	0x6	Load Switch2 GPIO Control Select
LDSWCONFIG	0x7	Load Switch Configuration
LDSW1LDOSEL	0x8	Load Switch1 / LDO Select
LDSW2LDOSEL	0x9	Load Switch2 / LDO Select
LDSW1VOUTSEL	0xC	LDO1 programmable output voltage
LDSW2VOUTSEL	0xD	LDO2 programmable output voltage

6.4.3.1 TASKLDSW1SET

Address offset: 0x0

Enable LDSW1

Bit number	7	6	5	4	3	2	1	0	
ID									A
Reset 0x00	0								0
ID	R/W	Field	Value ID	Value	Description				
A	W	TASKLDSW1SET			LDSW1_Enable request SET				
			NOEFFECT	0	no effect				
			SET	1	LDSW1 Enable request set				

6.4.3.2 TASKLDSW1CLR

Address offset: 0x1

Disable LDSW1

Bit number	7	6	5	4	3	2	1	0	
ID									A
Reset 0x00	0								0
ID	R/W	Field	Value ID	Value	Description				
A	W	TASKLDSW1CLR			LDSW1_Enable request CLR				
			NOEFFECT	0	no effect				
			CLR	1	LDSW1 Disable request clr				

6.4.3.3 TASKLDSW2SET

Address offset: 0x2

Enable LDSW2

Bit number						7	6	5	4	3	2	1	0							
ID													A							
Reset 0x00													0	0	0	0	0	0	0	0
ID	R/W	Field	Value ID	Value	Description															
A	W	TASKLDSW2SET			LDSW2_Enable request SET															
			NOEFFECT	0	no effect															
			SET	1	LDSW2 Enable request set															

6.4.3.4 TASKLDSW2CLR

Address offset: 0x3

Disable LDSW2

Bit number						7	6	5	4	3	2	1	0						
ID													A						
Reset 0x00													0	0	0	0	0	0	0
ID	R/W	Field	Value ID	Value	Description														
A	W	TASKLDSW2CLR			LDSW2_Enable request CLR														
			NOEFFECT	0	no effect														
			CLR	1	LDSW2 Disable request clr														

6.4.3.5 LDSWSTATUS

Address offset: 0x4

Load Switch Status

Bit number						7	6	5	4	3	2	1	0						
ID													E	D	C	B	A		
Reset 0x00													0	0	0	0	0	0	0
ID	R/W	Field	Value ID	Value	Description														
A	R	LDSW1PWRUPLDSW			Current status of LDSW1														
B	R	LDSW1PWRUPLDO			Current status of LDO1														
C	R	LDSW2PWRUPLDSW			Current status of LDSW2														
D	R	LDSW2PWRUPLDO			Current status of LDO1														
E	R	LDSWENABLE			Status of LDSW[n] and LDO[n]														

6.4.3.6 LDSW1GPISEL

Address offset: 0x5

Load Switch1 GPIO Control Select

Bit number						7	6	5	4	3	2	1	0						
ID													B	A	A	A			
Reset 0x00													0	0	0	0	0	0	0
ID	R/W	Field	Value ID	Value	Description														
A	RW	LDSW1GPISEL			Select which GPI controls Load Switch1														
			NOTUSED1	0	no GPI selected														
			GPIO0	1	GPI_0 selected														
			GPIO1	2	GPI_1 selected														
			GPIO2	3	GPI_2 selected														
			GPIO3	4	GPI_3 selected														
			GPIO4	5	GPI_4 selected														

Bit number						7	6	5	4	3	2	1	0
ID						B A A A							
Reset 0x00						0	0	0	0	0	0	0	0
ID	R/W	Field	Value ID	Value	Description								
			NOTUSED2	6	no GPI selected								
			NOTUSED3	7	no GPI selected								
B	RW	LDSW1GPIINV			Invert the sense of the selected GPIO								
			NORMAL	0	not inverted								
			INVERTED	1	Inverted								

6.4.3.7 LDSW2GPISEL

Address offset: 0x6

Load Switch2 GPIO Control Select

Bit number						7	6	5	4	3	2	1	0
ID						B A A A							
Reset 0x00						0	0	0	0	0	0	0	0
ID	R/W	Field	Value ID	Value	Description								
A	RW	LDSW2GPISEL			Select which GPI controls Load Switch2								
			NOTUSED1	0	no GPI selected								
			GPIO0	1	GPI_0 selected								
			GPIO1	2	GPI_1 selected								
			GPIO2	3	GPI_2 selected								
			GPIO3	4	GPI_3 selected								
			GPIO4	5	GPI_4 selected								
			NOTUSED2	6	no GPI selected								
			NOTUSED3	7	no GPI selected								
B	RW	LDSW2GPIINV			Invert the sense of the selected GPIO								
			NORMAL	0	not inverted								
			INVERTED	1	Inverted								

6.4.3.8 LDSWCONFIG

Address offset: 0x7

Load Switch Configuration

Bit number						7	6	5	4	3	2	1	0
ID						F E D C C B A							
Reset 0x00						0	0	0	0	0	0	0	0
ID	R/W	Field	Value ID	Value	Description								
A	RW	LDSW1SOFTSTARTDISABLE			Load Switch1 Soft Start Disable								
			NOEFFECT	0	no effect								
			NOSOFTSTART	1	Soft Start Disabled								
B	RW	LDSW2SOFTSTARTDISABLE			Load Switch2 Soft Start Disable								
			NOEFFECT	0	no effect								
			NOSOFTSTART	1	Soft Start Disabled								
C	RW	LDSW1SOFTSTARTSEL			Select Soft Start level for Load Switch1								
			10MA	0	10mA								
			20MA	1	20mA								
			35MA	2	35mA								
			50MA	3	50mA								
D	RW	LDSW2SOFTSTARTSEL			Select Soft Start level for Load Switch1								

Bit number						7	6	5	4	3	2	1	0
ID						F	E	D	D	C	C	B	A
Reset 0x00						0	0	0	0	0	0	0	0
ID	R/W	Field	Value ID	Value	Description								
			10MA	0	10mA								
			20MA	1	20mA								
			35MA	2	35mA								
			50MA	3	50mA								
E	RW	LDSW1ACTIVEDISCHARGE			Load Switch1 Active discharge Enable								
			NODISCHARGE	0	No Discharge								
			ACTIVE	1	Active Discharge Enabled								
F	RW	LDSW2ACTIVEDISCHARGE			Load Switch2 Active discharge Enable								
			NODISCHARGE	0	No Discharge								
			ACTIVE	1	Active Discharge Enabled								

6.4.3.9 LDSW1LDOSEL

Address offset: 0x8

Load Switch1 / LDO Select

Bit number						7	6	5	4	3	2	1	0
ID													A
Reset 0x00						0	0	0	0	0	0	0	0
ID	R/W	Field	Value ID	Value	Description								
A	RW	LDSW1LDOSEL			Select LDSW1 or LDO1								
			LDSW	0	Load Switch								
			LDO	1	LDO								

6.4.3.10 LDSW2LDOSEL

Address offset: 0x9

Load Switch2 / LDO Select

Bit number						7	6	5	4	3	2	1	0
ID													A
Reset 0x00						0	0	0	0	0	0	0	0
ID	R/W	Field	Value ID	Value	Description								
A	RW	LDSW2LDOSEL			Select LDSW2 or LDO2								
			LDSW	0	Load Switch								
			LDO	1	LDO								

6.4.3.11 LDSW1VOUTSEL

Address offset: 0xC

LDO1 programmable output voltage

Bit number						7	6	5	4	3	2	1	0			
ID													A	A	A	A
Reset 0x00						0	0	0	0	0	0	0	0			
ID	R/W	Field	Value ID	Value	Description											
A	RW	LDSW1VOUTSEL			Low-dropout regulator 1 programmable output voltage											
			1V	0	1V											

Bit number						7	6	5	4	3	2	1	0
ID						A	A	A	A	A			
Reset 0x00						0	0	0	0	0	0	0	0
ID	R/W	Field	Value ID	Value	Description								
			1V1	1	1.1V								
			1V2	2	1.2V								
			1V3	3	1.3V								
			1V4	4	1.4V								
			1V5	5	1.5V								
			1V6	6	1.6V								
			1V7	7	1.7V								
			1V8	8	1.8V								
			1V9	9	1.9V								
			2V	10	2V								
			2V1	11	2.1V								
			2V2	12	2.2V								
			2V3	13	2.3V								
			2V4	14	2.4V								
			2V5	15	2.5V								
			2V6	16	2.6V								
			2V7	17	2.7V								
			2V8	18	2.8V								
			2V9	19	2.9V								
			3V	20	3V								
			3V1	21	3.1V								
			3V2	22	3.2V								
			3V3	23	3.3V								

6.4.3.12 LDSW2VOUTSEL

Address offset: 0xD

LDO2 programmable output voltage

Bit number						7	6	5	4	3	2	1	0
ID						A	A	A	A	A			
Reset 0x00						0	0	0	0	0	0	0	0
ID	R/W	Field	Value ID	Value	Description								
A	RW	LDSW2VOUTSEL			Low-dropout regulator 2 programmable output voltage								
			1V	0	1V								
			1V1	1	1.1V								
			1V2	2	1.2V								
			1V3	3	1.3V								
			1V4	4	1.4V								
			1V5	5	1.5V								
			1V6	6	1.6V								
			1V7	7	1.7V								
			1V8	8	1.8V								
			1V9	9	1.9V								
			2V	10	2V								
			2V1	11	2.1V								
			2V2	12	2.2V								
			2V3	13	2.3V								
			2V4	14	2.4V								

Bit number						7	6	5	4	3	2	1	0
ID										A	A	A	A
Reset 0x00						0	0	0	0	0	0	0	0
ID	R/W	Field	Value ID	Value	Description								
			2V5	15	2.5V								
			2V6	16	2.6V								
			2V7	17	2.7V								
			2V8	18	2.8V								
			2V9	19	2.9V								
			3V	20	3V								
			3V1	21	3.1V								
			3V2	22	3.2V								
			3V3	23	3.3V								

6.5 LEDDRV — LED drivers

LEDDRV is made of three identical low-side LED drivers on pins **LED0**, **LED1**, and **LED2**. Pin configurations are independent of each other.

The pins can be configured in registers for the following purposes:

- Charge indication
- Charge error indication
- An RGB LED (requires all three pins)
- A general purpose, open-drain output

When a pin is used as a charging indication, the charging state machine controls LEDDRV.

Pins that are used as general purpose LED drivers have a control register containing separate bits for enabling each driver, see registers [LEDDRVOSET](#) on page 83 and [LEDDRVOCLR](#) on page 83. The host software will set or reset the control register bit, which alters the state of the LED associated with that register bit.

LEDDRV can be used as open-drain digital output. Open Drain mode is the same as the general purpose LED drivers but with the LED removed. An external pull up resistor is required for each LED pin operating in Open Drain mode.

The system can control an RGB LED component (or three separate LEDs) . The **LED0**, **LED1**, and **LED2** pins can connect to any of the RGB LED cathodes (low-side). The anodes (common or individual) must be connected to the **VSYS** pin. The R, G, or B value is activated by enabling the associated LED register. Combinations of RG, RB, GB, and RGB are possible.

6.5.1 Electrical specification

Symbol	Description	Min.	Typ.	Max.	Unit
I_{LED}	LED driver current		5		mA
V_{LEDn}	Voltage on pin LED0 , LED1 , and LED2	0.5		VSYS	V

Table 25: LEDDRV electrical specification

6.5.2 Registers

Instances

Instance	Base address	Description
LEDDRV	0x0000A00	LEDDRV registers LEDDRV register map

Register overview

Register	Offset	Description
LEDDRV0MODESEL	0x0	Select for LED_0 mode
LEDDRV1MODESEL	0x1	Select for LED_1 mode
LEDDRV2MODESEL	0x2	Select for LED_2 mode
LEDDRV0SET	0x3	Set LED_0 to be On
LEDDRV0CLR	0x4	Clear LED_0 to be Off
LEDDRV1SET	0x5	Set LED_1 to be On
LEDDRV1CLR	0x6	Clear LED_1 to be Off
LEDDRV2SET	0x7	Set LED_2 to be On
LEDDRV2CLR	0x8	Clear LED_2 to be Off

6.5.2.1 LEDDRV0MODESEL

Address offset: 0x0

Select for LED_0 mode

Bit number	7 6 5 4 3 2 1 0						
ID	A A						
Reset 0x00	0 0 0 0 0 0 0 0						
ID	R/W	Field	Value ID	Value	Description		
A	RW	LEDDRV0MODESEL			Select for LED0 mode		
			ERROR	0	Error condition from Charger		
			CHARGING	1	Charging indicator (On during charging)		
			HOST	2	Driven from register LEDDRV_0_SET/CLR		
			NOTUSED	3	Not used		

6.5.2.2 LEDDRV1MODESEL

Address offset: 0x1

Select for LED_1 mode

Bit number	7 6 5 4 3 2 1 0						
ID	A A						
Reset 0x01	0 0 0 0 0 0 0 1						
ID	R/W	Field	Value ID	Value	Description		
A	RW	LEDDRV1MODESEL			Select for LED1 mode		
			ERROR	0	Error condition from Charger		
			CHARGING	1	Charging indicator (On during charging)		
			HOST	2	Driven from register LEDDRV_1_SET/CLR		
			NOTUSED	3	Not used		

6.5.2.3 LEDDRV2MODESEL

Address offset: 0x2

Select for LED_2 mode

Bit number	7	6	5	4	3	2	1	0	
ID								A	A
Reset 0x02	0	0	0	0	0	0	0	1	
ID	R/W	Field	Value ID	Value	Description				
A	RW	LEDDRV2MODESEL			Select for LED2 mode				
			ERROR	0	Error condition from Charger				
			CHARGING	1	Charging indicator (On during charging)				
			HOST	2	Driven from register LEDDRV_2_SET/CLR				
			NOTUSED	3	Not used				

6.5.2.4 LEDDRV0SET

Address offset: 0x3

Set LED_0 to be On

Bit number	7	6	5	4	3	2	1	0	
ID								A	A
Reset 0x00	0	0	0	0	0	0	0	0	
ID	R/W	Field	Value ID	Value	Description				
A	W	LEDDRV0ON			Set LED0 to be On				
			NOEFFECT	0	no effect				
			SET	1	Turns ON LED0 if leddrvModeSel is in HOST mode				

6.5.2.5 LEDDRV0CLR

Address offset: 0x4

Clear LED_0 to be Off

Bit number	7	6	5	4	3	2	1	0	
ID								A	A
Reset 0x00	0	0	0	0	0	0	0	0	
ID	R/W	Field	Value ID	Value	Description				
A	W	LEDDRV0OFF			Set LED0 to be Off				
			NOEFFECT	0	no effect				
			CLR	1	Turns OFF LED0 if leddrvModeSel is in HOST mode				

6.5.2.6 LEDDRV1SET

Address offset: 0x5

Set LED_1 to be On

Bit number						7	6	5	4	3	2	1	0							
ID													A							
Reset 0x00													0	0	0	0	0	0	0	0
ID	R/W	Field	Value ID	Value	Description															
A	W	LEDDRV1ON			Set LED1 to be On															
			NOEFFECT	0	no effect															
			SET	1	Turns ON LED1 if leddrvModeSel is in HOST mode															

6.5.2.7 LEDDRV1CLR

Address offset: 0x6

Clear LED_1 to be Off

Bit number						7	6	5	4	3	2	1	0							
ID													A							
Reset 0x00													0	0	0	0	0	0	0	0
ID	R/W	Field	Value ID	Value	Description															
A	W	LEDDRV1OFF			Set LED1 to be Off															
			NOEFFECT	0	no effect															
			CLR	1	Turns OFF LED1 if leddrvModeSel is in HOST mode															

6.5.2.8 LEDDRV2SET

Address offset: 0x7

Set LED_2 to be On

Bit number						7	6	5	4	3	2	1	0							
ID													A							
Reset 0x00													0	0	0	0	0	0	0	0
ID	R/W	Field	Value ID	Value	Description															
A	W	LEDDRV2ON			Set LED2 to be On															
			NOEFFECT	0	no effect															
			SET	1	Turns ON LED2 if leddrvModeSel is in HOST mode															

6.5.2.9 LEDDRV2CLR

Address offset: 0x8

Clear LED_2 to be Off

Bit number						7	6	5	4	3	2	1	0							
ID													A							
Reset 0x00													0	0	0	0	0	0	0	0
ID	R/W	Field	Value ID	Value	Description															
A	W	LEDDRV2OFF			Set LED2 to be Off															
			NOEFFECT	0	no effect															
			CLR	1	Turns OFF LED2 if leddrvModeSel is in HOST mode															

6.6 GPIO — General purpose input/output

By default, the general purpose input/output pins, **GPIO [n]**, are set as input with weak pull-down. GPIO is supplied by the **VDDIO** pin.

The number of GPIOs varies with product variant and package. See [Pin assignments](#) on page 150 for more information about the number of supported GPIOs.

GPIO has the following configurable features:

- General purpose input
- Control input
- Output
- BUCK control
- LOADSW control

Note: Events may occur when GPIO configuration is changed on the fly.

Pull-down is prioritized if both pull-up and pull-down are activated on a GPIO pin at the same time.

The following figure shows BUCK control.

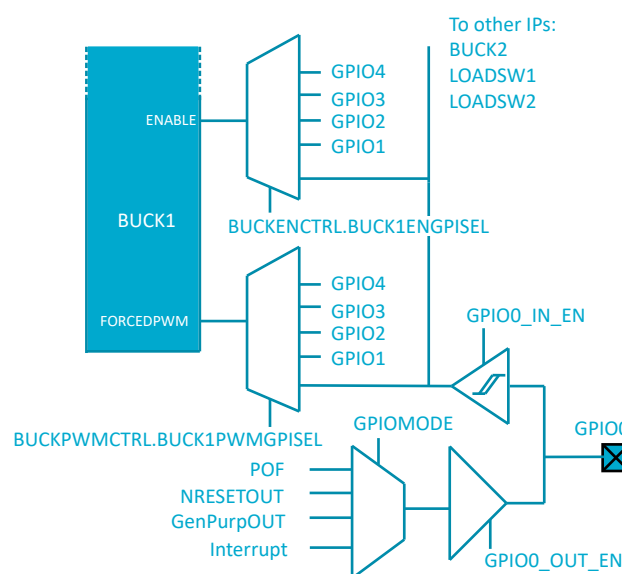

Figure 41: GPIO concept

Pins **LED0**, **LED1**, and **LED2** can be used as open-drain outputs, see [LEDDRV — LED drivers](#) on page 81.

6.6.1 Pin configuration

The GPIO peripheral implements up to 5 pins, **GPIO[0 . . . 4]**. Each of these pins can be individually configured in the **GPIO MODE[n]** registers.

General purpose input

GPIO can be used as a general purpose input to monitor the input logic level. Debounce is set in register **GPIO.DEBOUNCE[n]**. Set **GPI.INPUT** to use **GPIO[n]** without setting an event.

It can also be used as an input to trigger an event. Set bit **GPI.RISING.EVENT** to generate an event on the rising edge. To generate an event on a falling edge, set bit **GPI.FALLING.EVENT**. The events are visible in the register **EVENTSGPIOSSET** on page 142.

To override GPIO input states, set bit **GPI.LOGIC[n]**.

Control input

For a pin to function as a control input, write 0 in bit GPI.INPUT. Debounce is set in register [GPIO.DEBOUNCE\[n\]](#). The following components can be controlled through GPIO once enabled in the corresponding register.

- LOADSW – Registers [LDSW1GPISEL](#) on page 77 or [LDSW2GPISEL](#) on page 78
- BUCK – Register [BUCKENCTRL](#) on page 68
- BUCK forced PWM mode – Register [BUCKPWMCTRL](#) on page 69
- BUCK **VOU**T [n] voltage level selection for active and retention modes – Register [BUCKVRETCTRL](#) on page 68
- Second reset button – **GPIO0** only, see [Two-button reset](#) on page 121

Output

The GPIO outputs can be configured as logic outputs or open drain outputs in register [GPIO.OPEN.DRAIN\[n\]](#).

When setting a GPIO as output, the host software disables any pull-up or pull-down on that GPIO. After a reset, the default is for pull-down to be enabled.

GPIO can be used as a general purpose output by setting bit [GPO.LOGIC\[n\]](#).

GPIO can be used as an interrupt by setting one or more from the following registers:

- [INTENEVENTSADCSET](#) on page 125
- [INTEN.EVENTS.BCHARGER\[n\]SET](#)
- [INTENEVENTSSHPHLDSET](#) on page 135
- [INTEN.EVENTS.VBUSIN\[n\]SET](#)
- [INTENEVENTSGPIOSET](#) on page 143

GPIO can indicate a watchdog event when the watchdog expires. Select bit [GPO.RESET](#) to enable watchdog events.

An imminent power failure warning can be set by selecting bit [GPO.PLW](#).

Drive strength can be selected in register [GPIODRIVE\[0\]](#) on page 90. Weak pull-up and pull-down resistors are available in the following registers:

- [GPIO.PDEN\[n\]](#)
- [GPIO.PUEN\[n\]](#)

6.6.2 Electrical specification

Symbol	Description	Min.	Typ.	Max.	Unit
V _{IH}	Input high voltage	0.7 x VDDIO		VDDIO	V
V _{IL}	Input low voltage	AVSS		0.3 x VDDIO	V
PU _{GPIO}	Weak pull-up resistor		500		kΩ
PD _{GPIO}	Weak pull-down resistor		500		kΩ
DB _{GPIO}	Input debounce time (DEBOUNCE1=1)		20		ms

Table 26: GPIO electrical specification

6.6.3 Registers

Instances

Instance	Base address	Description
GPIOs	0x00000600	GPIO Registers GPIOs register map

Register overview

Register	Offset	Description
GIOMODE[0]	0x0	GPIO Mode Configuration
GIOMODE[1]	0x1	GPIO Mode Configuration
GIOMODE[2]	0x2	GPIO Mode Configuration
GIOMODE[3]	0x3	GPIO Mode Configuration
GIOMODE[4]	0x4	GPIO Mode Configuration
GIODRIVE[0]	0x5	GPIO Drive strength Configuration
GIODRIVE[1]	0x6	GPIO Drive strength Configuration
GIODRIVE[2]	0x7	GPIO Drive strength Configuration
GIODRIVE[3]	0x8	GPIO Drive strength Configuration
GIODRIVE[4]	0x9	GPIO Drive strength Configuration
GPIOPUEN[0]	0xA	GPIO Pull-up Enable Configuration
GPIOPUEN[1]	0xB	GPIO Pull-up Enable Configuration
GPIOPUEN[2]	0xC	GPIO Pull-up Enable Configuration
GPIOPUEN[3]	0xD	GPIO Pull-up Enable Configuration
GPIOPUEN[4]	0xE	GPIO Pull-up Enable Configuration
GIOPDEN[0]	0xF	GPIO Pull-down Enable Configuration
GIOPDEN[1]	0x10	GPIO Pull-down Enable Configuration
GIOPDEN[2]	0x11	GPIO Pull-down Enable Configuration
GIOPDEN[3]	0x12	GPIO Pull-down Enable Configuration
GIOPDEN[4]	0x13	GPIO Pull-down Enable Configuration
GPIOPENDRAIN[0]	0x14	GPIO Open Drain Configuration
GPIOPENDRAIN[1]	0x15	GPIO Open Drain Configuration
GPIOPENDRAIN[2]	0x16	GPIO Open Drain Configuration
GPIOPENDRAIN[3]	0x17	GPIO Open Drain Configuration
GPIOPENDRAIN[4]	0x18	GPIO Open Drain Configuration
GPIODEBOUNCE[0]	0x19	GPIO Debounce Configuration
GPIODEBOUNCE[1]	0x1A	GPIO Debounce Configuration
GPIODEBOUNCE[2]	0x1B	GPIO Debounce Configuration
GPIODEBOUNCE[3]	0x1C	GPIO Debounce Configuration
GPIODEBOUNCE[4]	0x1D	GPIO Debounce Configuration
GPIOSTATUS	0x1E	GPIO Status from GPIO Pads

6.6.3.1 GIOMODE[0]

Address offset: 0x0

GPIO Mode Configuration

Bit number						7	6	5	4	3	2	1	0
ID										A	A	A	A
Reset 0x00						0	0	0	0	0	0	0	0
ID	R/W	Field	Value ID	Value	Description								
A	RW	GPIOMODE			Config for GPIO mode selection								
			GPIINPUT	0	GPI Input								
			GPILOGIC1	1	GPI Logic1								
			GPILOGIC0	2	GPI Logic0								
			GPIEVENTRISE	3	GPI Rising Edge Event								
			GPIEVENTFALL	4	GPI Falling Edge Event								
			GPOIRQ	5	GPO Interrupt								
			GPORESET	6	GPO Reset								
			GPOPLW	7	GPO PwrLossWarn								
			GPOLOGIC1	8	GPO Logic1								
			GPOLOGIC0	9	GPO Logic0								

6.6.3.2 GPIOMODE[1]

Address offset: 0x1

GPIO Mode Configuration

Bit number						7	6	5	4	3	2	1	0
ID										A	A	A	A
Reset 0x00						0	0	0	0	0	0	0	0
ID	R/W	Field	Value ID	Value	Description								
A	RW	GPIOMODE			Config for GPIO mode selection								
			GPIINPUT	0	GPI Input								
			GPILOGIC1	1	GPI Logic1								
			GPILOGIC0	2	GPI Logic0								
			GPIEVENTRISE	3	GPI Rising Edge Event								
			GPIEVENTFALL	4	GPI Falling Edge Event								
			GPOIRQ	5	GPO Interrupt								
			GPORESET	6	GPO Reset								
			GPOPLW	7	GPO PwrLossWarn								
			GPOLOGIC1	8	GPO Logic1								
			GPOLOGIC0	9	GPO Logic0								

6.6.3.3 GPIOMODE[2]

Address offset: 0x2

GPIO Mode Configuration

Bit number						7	6	5	4	3	2	1	0
ID										A	A	A	A
Reset 0x00						0	0	0	0	0	0	0	0
ID	R/W	Field	Value ID	Value	Description								
A	RW	GPIOMODE			Config for GPIO mode selection								
			GPIINPUT	0	GPI Input								
			GPILOGIC1	1	GPI Logic1								
			GPILOGIC0	2	GPI Logic0								
			GPIEVENTRISE	3	GPI Rising Edge Event								
			GPIEVENTFALL	4	GPI Falling Edge Event								
			GPOIRQ	5	GPO Interrupt								

Bit number						7	6	5	4	3	2	1	0
ID										A	A	A	A
Reset 0x00						0	0	0	0	0	0	0	0
ID	R/W	Field	Value ID	Value	Description								
			GPORESET	6	GPO Reset								
			GPOPLW	7	GPO PwrLossWarn								
			GPOLOGIC1	8	GPO Logic1								
			GPOLOGIC0	9	GPO Logic0								

6.6.3.4 GPIOMODE[3]

Address offset: 0x3

GPIO Mode Configuration

Bit number						7	6	5	4	3	2	1	0
ID										A	A	A	A
Reset 0x00						0	0	0	0	0	0	0	0
ID	R/W	Field	Value ID	Value	Description								
A	RW	GPIOMODE			Config for GPIO mode selection								
			GPIINPUT	0	GPI Input								
			GPILOGIC1	1	GPI Logic1								
			GPILOGIC0	2	GPI Logic0								
			GPIEVENTRISE	3	GPI Rising Edge Event								
			GPIEVENTFALL	4	GPI Falling Edge Event								
			GPOIRQ	5	GPO Interrupt								
			GPORESET	6	GPO Reset								
			GPOPLW	7	GPO PwrLossWarn								
			GPOLOGIC1	8	GPO Logic1								
			GPOLOGIC0	9	GPO Logic0								

6.6.3.5 GPIOMODE[4]

Address offset: 0x4

GPIO Mode Configuration

Bit number						7	6	5	4	3	2	1	0
ID										A	A	A	A
Reset 0x00						0	0	0	0	0	0	0	0
ID	R/W	Field	Value ID	Value	Description								
A	RW	GPIOMODE			Config for GPIO mode selection								
			GPIINPUT	0	GPI Input								
			GPILOGIC1	1	GPI Logic1								
			GPILOGIC0	2	GPI Logic0								
			GPIEVENTRISE	3	GPI Rising Edge Event								
			GPIEVENTFALL	4	GPI Falling Edge Event								
			GPOIRQ	5	GPO Interrupt								
			GPORESET	6	GPO Reset								
			GPOPLW	7	GPO PwrLossWarn								
			GPOLOGIC1	8	GPO Logic1								
			GPOLOGIC0	9	GPO Logic0								

6.6.3.6 GPIODRIVE[0]

Address offset: 0x5

GPIO Drive strength Configuration

Bit number						7	6	5	4	3	2	1	0
ID													A
Reset 0x00													0 0 0 0 0 0 0 0
ID	R/W	Field	Value ID	Value	Description								
A	RW	GPIODRIVE			Config for GPIO drive strength								
			1MA	0	1mA								
			6MA	1	6mA								

6.6.3.7 GPIODRIVE[1]

Address offset: 0x6

GPIO Drive strength Configuration

Bit number						7	6	5	4	3	2	1	0
ID													A
Reset 0x00													0 0 0 0 0 0 0 0
ID	R/W	Field	Value ID	Value	Description								
A	RW	GPIODRIVE			Config for GPIO drive strength								
			1MA	0	1mA								
			6MA	1	6mA								

6.6.3.8 GPIODRIVE[2]

Address offset: 0x7

GPIO Drive strength Configuration

Bit number						7	6	5	4	3	2	1	0
ID													A
Reset 0x00													0 0 0 0 0 0 0 0
ID	R/W	Field	Value ID	Value	Description								
A	RW	GPIODRIVE			Config for GPIO drive strength								
			1MA	0	1mA								
			6MA	1	6mA								

6.6.3.9 GPIODRIVE[3]

Address offset: 0x8

GPIO Drive strength Configuration

Bit number						7	6	5	4	3	2	1	0
ID													A
Reset 0x00													0 0 0 0 0 0 0 0
ID	R/W	Field	Value ID	Value	Description								
A	RW	GPIODRIVE			Config for GPIO drive strength								
			1MA	0	1mA								
			6MA	1	6mA								

6.6.3.10 GPIODRIVE[4]

Address offset: 0x9

GPIO Drive strength Configuration

Bit number		7 6 5 4 3 2 1 0						
ID								A
Reset 0x00		0 0 0 0 0 0 0 0						
ID	R/W	Field	Value ID	Value	Description			
A	RW	GPIODRIVE			Config for GPIO drive strength			
			1mA	0	1mA			
			6mA	1	6mA			

6.6.3.11 GPIOPUEN[0]

Address offset: 0xA

GPIO Pull-up Enable Configuration

Bit number		7 6 5 4 3 2 1 0						
ID								A
Reset 0x00		0 0 0 0 0 0 0 0						
ID	R/W	Field	Value ID	Value	Description			
A	RW	GPIOPUEN			Config for GPIO pull-up enable			
			PULLUP0	0	Pull Up Disable			
			PULLUP1	1	Pull Up Enable			

6.6.3.12 GPIOPUEN[1]

Address offset: 0xB

GPIO Pull-up Enable Configuration

Bit number		7 6 5 4 3 2 1 0						
ID								A
Reset 0x00		0 0 0 0 0 0 0 0						
ID	R/W	Field	Value ID	Value	Description			
A	RW	GPIOPUEN			Config for GPIO pull-up enable			
			PULLUP0	0	Pull Up Disable			
			PULLUP1	1	Pull Up Enable			

6.6.3.13 GPIOPUEN[2]

Address offset: 0xC

GPIO Pull-up Enable Configuration

Bit number		7 6 5 4 3 2 1 0						
ID								A
Reset 0x00		0 0 0 0 0 0 0 0						
ID	R/W	Field	Value ID	Value	Description			
A	RW	GPIOPUEN			Config for GPIO pull-up enable			
			PULLUP0	0	Pull Up Disable			
			PULLUP1	1	Pull Up Enable			

6.6.3.14 GPIOPUEN[3]

Address offset: 0xD

GPIO Pull-up Enable Configuration

Bit number						7	6	5	4	3	2	1	0
ID	A												
Reset 0x00	0 0 0 0 0 0 0 0												
ID	R/W	Field	Value ID	Value	Description								
A	RW	GPIOPUEN			Config for GPIO pull-up enable								
			PULLUP0	0	Pull Up Disable								
			PULLUP1	1	Pull Up Enable								

6.6.3.15 GPIOPUEN[4]

Address offset: 0xE

GPIO Pull-up Enable Configuration

Bit number						7	6	5	4	3	2	1	0
ID	A												
Reset 0x00	0 0 0 0 0 0 0 0												
ID	R/W	Field	Value ID	Value	Description								
A	RW	GPIOPUEN			Config for GPIO pull-up enable								
			PULLUP0	0	Pull Up Disable								
			PULLUP1	1	Pull Up Enable								

6.6.3.16 GPIOPDEN[0]

Address offset: 0xF

GPIO Pull-down Enable Configuration

Bit number						7	6	5	4	3	2	1	0
ID	A												
Reset 0x01	0 0 0 0 0 0 0 1												
ID	R/W	Field	Value ID	Value	Description								
A	RW	GPIOPDEN			Config for GPIO pull-down enable								
			PULLDOWN0	0	Pull Down Disable								
			PULLDOWN1	1	Pull Down Enable								

6.6.3.17 GPIOPDEN[1]

Address offset: 0x10

GPIO Pull-down Enable Configuration

Bit number						7	6	5	4	3	2	1	0
ID	A												
Reset 0x01	0 0 0 0 0 0 0 1												
ID	R/W	Field	Value ID	Value	Description								
A	RW	GPIOPDEN			Config for GPIO pull-down enable								
			PULLDOWN0	0	Pull Down Disable								
			PULLDOWN1	1	Pull Down Enable								

6.6.3.18 GPIOPDEN[2]

Address offset: 0x11

GPIO Pull-down Enable Configuration

Bit number	7	6	5	4	3	2	1	0
ID								A
Reset 0x01	0	0	0	0	0	0	0	1
ID	R/W	Field	Value ID	Value	Description			
A	RW	GPIOPDEN			Config for GPIO pull-down enable			
			PULLDOWN0	0	Pull Down Disable			
			PULLDOWN1	1	Pull Down Enable			

6.6.3.19 GPIOPDEN[3]

Address offset: 0x12

GPIO Pull-down Enable Configuration

Bit number	7	6	5	4	3	2	1	0
ID								A
Reset 0x01	0	0	0	0	0	0	0	1
ID	R/W	Field	Value ID	Value	Description			
A	RW	GPIOPDEN			Config for GPIO pull-down enable			
			PULLDOWN0	0	Pull Down Disable			
			PULLDOWN1	1	Pull Down Enable			

6.6.3.20 GPIOPDEN[4]

Address offset: 0x13

GPIO Pull-down Enable Configuration

Bit number	7	6	5	4	3	2	1	0
ID								A
Reset 0x01	0	0	0	0	0	0	0	1
ID	R/W	Field	Value ID	Value	Description			
A	RW	GPIOPDEN			Config for GPIO pull-down enable			
			PULLDOWN0	0	Pull Down Disable			
			PULLDOWN1	1	Pull Down Enable			

6.6.3.21 GPIOPENDRAIN[0]

Address offset: 0x14

GPIO Open Drain Configuration

Bit number	7	6	5	4	3	2	1	0
ID								A
Reset 0x00	0	0	0	0	0	0	0	0
ID	R/W	Field	Value ID	Value	Description			
A	RW	GPIOPENDRAIN			Config for GPIO open drain			
			OPENDRAIN0	0	Open Drain Disable			
			OPENDRAIN1	1	Open Drain Enable			

6.6.3.22 GPIOOPENDRAIN[1]

Address offset: 0x15

GPIO Open Drain Configuration

Bit number						7	6	5	4	3	2	1	0
ID													A
Reset 0x00						0	0	0	0	0	0	0	0
ID	R/W	Field	Value ID	Value	Description								
A	RW	GPIOOPENDRAIN			Config for GPIO open drain								
			OPENDRAIN0	0	Open Drain Disable								
			OPENDRAIN1	1	Open Drain Enable								

6.6.3.23 GPIOOPENDRAIN[2]

Address offset: 0x16

GPIO Open Drain Configuration

Bit number						7	6	5	4	3	2	1	0
ID													A
Reset 0x00						0	0	0	0	0	0	0	0
ID	R/W	Field	Value ID	Value	Description								
A	RW	GPIOOPENDRAIN			Config for GPIO open drain								
			OPENDRAIN0	0	Open Drain Disable								
			OPENDRAIN1	1	Open Drain Enable								

6.6.3.24 GPIOOPENDRAIN[3]

Address offset: 0x17

GPIO Open Drain Configuration

Bit number						7	6	5	4	3	2	1	0
ID													A
Reset 0x00						0	0	0	0	0	0	0	0
ID	R/W	Field	Value ID	Value	Description								
A	RW	GPIOOPENDRAIN			Config for GPIO open drain								
			OPENDRAIN0	0	Open Drain Disable								
			OPENDRAIN1	1	Open Drain Enable								

6.6.3.25 GPIOOPENDRAIN[4]

Address offset: 0x18

GPIO Open Drain Configuration

Bit number						7	6	5	4	3	2	1	0
ID													A
Reset 0x00						0	0	0	0	0	0	0	0
ID	R/W	Field	Value ID	Value	Description								
A	RW	GPIOOPENDRAIN			Config for GPIO open drain								
			OPENDRAIN0	0	Open Drain Disable								
			OPENDRAIN1	1	Open Drain Enable								

6.6.3.26 GPIODEBOUNCE[0]

Address offset: 0x19

GPIO Debounce Configuration

Bit number	7	6	5	4	3	2	1	0	
ID									A
Reset 0x00	0	0	0	0	0	0	0	0	
ID	R/W	Field	Value ID	Value	Description				
A	RW	GPIODEBOUNCE			Config for GPIO debounce				
			DEBOUNCE0	0	Debounce Disable				
			DEBOUNCE1	1	Debounce Enable				

6.6.3.27 GPIODEBOUNCE[1]

Address offset: 0x1A

GPIO Debounce Configuration

Bit number	7	6	5	4	3	2	1	0	
ID									A
Reset 0x00	0	0	0	0	0	0	0	0	
ID	R/W	Field	Value ID	Value	Description				
A	RW	GPIODEBOUNCE			Config for GPIO debounce				
			DEBOUNCE0	0	Debounce Disable				
			DEBOUNCE1	1	Debounce Enable				

6.6.3.28 GPIODEBOUNCE[2]

Address offset: 0x1B

GPIO Debounce Configuration

Bit number	7	6	5	4	3	2	1	0	
ID									A
Reset 0x00	0	0	0	0	0	0	0	0	
ID	R/W	Field	Value ID	Value	Description				
A	RW	GPIODEBOUNCE			Config for GPIO debounce				
			DEBOUNCE0	0	Debounce Disable				
			DEBOUNCE1	1	Debounce Enable				

6.6.3.29 GPIODEBOUNCE[3]

Address offset: 0x1C

GPIO Debounce Configuration

Bit number	7	6	5	4	3	2	1	0	
ID									A
Reset 0x00	0	0	0	0	0	0	0	0	
ID	R/W	Field	Value ID	Value	Description				
A	RW	GPIODEBOUNCE			Config for GPIO debounce				
			DEBOUNCE0	0	Debounce Disable				
			DEBOUNCE1	1	Debounce Enable				

6.6.3.30 GPIODEBOUNCE[4]

Address offset: 0x1D

GPIO Debounce Configuration

Bit number		7 6 5 4 3 2 1 0						
ID								A
Reset 0x00		0 0 0 0 0 0 0 0						
ID	R/W	Field	Value ID	Value	Description			
A	RW	GPIODEBOUNCE			Config for GPIO debounce			
			DEBOUNCE0	0	Debounce Disable			
			DEBOUNCE1	1	Debounce Enable			

6.6.3.31 GPIOSTATUS

Address offset: 0x1E

GPIO Status from GPIO Pads

Bit number		7 6 5 4 3 2 1 0						
ID								E D C B A
Reset 0x00		0 0 0 0 0 0 0 0						
ID	R/W	Field	Value ID	Value	Description			
A	R	GPIO0STATUS			gpio0Status			
			LOW	0	Input Low			
			HIGH	1	Input High			
B	R	GPIO1STATUS			gpio1Status			
			LOW	0	Input Low			
			HIGH	1	Input High			
C	R	GPIO2STATUS			gpio2Status			
			LOW	0	Input Low			
			HIGH	1	Input High			
D	R	GPIO3STATUS			gpio3Status			
			LOW	0	Input Low			
			HIGH	1	Input High			
E	R	GPIO4STATUS			gpio4Status			
			LOW	0	Input Low			
			HIGH	1	Input High			

7 System features

7.1 System Monitor

The chip includes a 10-bit ADC which is used for measuring internal parameters. It can be used in the following measurement modes:

- Single-shot
- Automatic
- Timed

Measurement request priority

When multiple measurement requests happen at the same time, the priority is as follows:

1. VBAT
2. Battery temperature, T_{BAT}
3. Battery current, I_{BAT}
4. Die temperature, T_{DIE}
5. VSYS
6. VBUS

If a measurement has been requested but the measurement has not started, a higher priority can be requested.

When a low priority measurement is requested and the system has started the measurement, a higher priority can be requested. The system will complete the lower priority measurement before the higher priority measurement.

7.1.1 Single-shot measurements

Single-shot measurements are triggered by a task specific for each measurement.

Value	Task
Battery temperature	TASKNTCMEASURE on page 102
Battery voltage, Single-shot mode and Burst mode	TASKVBATMEASURE on page 102 ADCCONFIG on page 104
VSYS voltage	TASKVSYSMEASURE on page 103
Battery current	ADCIBATMEASEN on page 108 (occurs after VBAT measurement)
VBUS voltage	TASKVBUS7MEASURE on page 103
Die temperature	TASKTEMPMEASURE on page 102

Table 27: Tasks for single-shot measurements

A VBAT measurement triggered in Burst mode performs four consecutive measurements, with each result available separately. Conversions are run back-to-back and complete in t_{CONV} .

Note: To repeat a measurement, it must be requested once the previous request is complete. Repeat measurement requests are lost when made while the previous conversion is still ongoing. Alternate measurements can be requested, which are queued. See [Priority](#) for more information.

7.1.2 Automatic measurements

Automatic measurements for battery voltage are enabled in register [ADCCONFIG](#) on page 104. The default interval is 1024 ms.

7.1.2.1 Automatic measurements during charging

Battery temperature and die temperature are measured automatically at regular intervals when the battery is charging. The host software can read this value and returns the latest measurement.

The measurement intervals are as follows:

- Battery temperature – once every 64, 128, or 1024 ms. This information is used by the charging FSM.
- Die temperature – once every 4 ms, see [Charger thermal regulation](#) on page 30.

Note: To enable automatic thermistor and die temperature monitoring, set register [TASKAUTOTIMUPDATE](#) on page 105. This should also be set after changing the automated period.

7.1.3 Timed measurements

Timed measurements for battery voltage in Single-shot mode and Burst mode are initiated in register [ADCDELTIMCONF](#) on page 105. See [Monitor battery state of charge](#) on page 100 for more information.

7.1.4 Measurement results

Results from the ADC are stored in registers according to the following table. Some registers hold alternate results when that feature is requested. Host software must concatenate the LSB to the MSB of the result register for full accuracy.

Value/alternate result	Register
VBAT	ADCVBATRESULTMSB on page 105
Battery temperature	ADCNTCRESULTMSB on page 106
Die temperature	ADCTEMPRESULTMSB on page 106
VSYS Single-shot mode	ADCVSYSRESULTMSB on page 106
LSBs for Single-shot mode VSYS, Die temperature, NTC thermistor, and VBAT	ADCGP0RESULTLSBS on page 106
Burst mode VBAT0	ADCVBAT0RESULTMSB on page 106
Burst mode VBAT1	ADCVBAT1RESULTMSB on page 107
Burst mode VBAT2 Battery current IBAT	ADCVBAT2RESULTMSB on page 107
Burst mode VBAT3 Single-shot mode VBUS	ADCVBAT3RESULTMSB on page 107
LSBs for Burst mode VBAT0, VBAT1, VBAT2, VBAT3, IBAT and VBUS	ADCGP1RESULTLSBS on page 107

Table 28: ADC measurements

The following equations can be used to read the results.

VBAT

The equation for VBAT is given by the following:

$$V_{\text{BAT}} = \frac{V_{\text{BATADC}}}{1023} V_{\text{FS}_{\text{VBAT}}}$$

Here, V_{BATADC} is the ADC value from the VBAT register and $V_{\text{FS}_{\text{VBAT}}}$ is the full scale voltage for measuring VBAT.

VBUS

The equation for VBUS is given by the following:

$$V_{\text{BUS}} = \frac{V_{\text{BUSADC}}}{1023} V_{\text{FS}_{\text{VBUS}}}$$

Here, V_{BUSADC} is the ADC value from the VBUS register and $V_{\text{FS}_{\text{VBUS}}}$ is the full scale voltage for measuring VBUS.

VSYS

Equation for VSYS is given by the following:

$$V_{\text{SYS}} = \frac{V_{\text{SYSADC}}}{1023} V_{\text{FS}_{\text{VSYS}}}$$

Here, V_{SYSADC} is the ADC value from the VBUS register and $V_{\text{FS}_{\text{VSYS}}}$ is the full scale voltage for measuring VBUS.

Battery temperature (Kelvin)

The battery temperature T_{BAT} (in Kelvin) is given by the following equation:

$$T_{\text{BAT}} = \frac{1}{\frac{1}{T_0} - \frac{1}{\beta} \cdot \ln\left(\frac{1024}{T_{\text{BATADC}}} - 1\right)}$$

Here, $T_0 = 298.15$ K, T_{BATADC} is the ADC value from the battery temperature register `ADCNTCRESULTMSB` and β is the NTC beta parameter.

Die temperature in °C

The die temperature, T_{D} (in °C), is given by the following equation:

$$T_{\text{D}} = 394.67 - 0.7926 \cdot K_{\text{DIETEMP}}$$

Here, K_{DIETEMP} is the temperature limit code variable.

7.1.5 Events and interrupts

An event register and interrupt are available for each measurement and are issued once the measurement has been completed.

See registers `EVENTSADCSET` on page 124, `EVENTSADCCLR` on page 124, `INTENEVENTSADCSET` on page 125, and `INTENEVENTSADCCLR` on page 126.

7.1.6 Battery temperature measurement

Before using a battery temperature measurement, the appropriate NTC thermistor must be configured. See [Monitor battery temperature](#) on page 29 for information about suitable thermistors and how to configure.

7.1.7 Monitor battery state of charge

The host runs the fuel gauge algorithm and periodically requests measurements from the ADC. These measurements update the algorithm parameters and allow the state of charge to be determined.

The algorithm must be provided with the battery model parameters for accurate fuel gauge readings. The battery model parameters can be created from the nPM PowerUP application.

Once the battery is modeled over the operating temperature range, the fuel gauge algorithm is optimized to operate over the full range of battery voltages, temperatures, and application currents.

7.1.8 Battery current measurement

Host software can request a IBAT measurement by setting bit `IBAT.MEAS.ENABLE` to 1 in register `ADCIBATMEASEN` on page 108. This allows consecutive VBAT and IBAT measurements. When both measurements are available in the ADC registers, the `ADCIBATRDY` event is generated. See register `ADCIBATMEASSTATUS` on page 105 for more information about the IBAT measurement.

Measurements are invalid and a new measurement is needed when bit `IBAT.MEASE.INVALID` is set.

Direction of current flow is shown in bit `BCHARGER.MODE`.

A value of 01 means the battery is discharging. During a discharge, the full scale current is the weighted sum of registers `BCHGETDISCHARGEMSB` and `BCHGETDISCHARGELSB` multiplied by 0.836.

A value of 11 means the battery is charging. When charging, the full scale current is the weighted sum of registers `BCHGETMSB` and `BCHGETLSB` multiplied by 1.25.

7.1.9 Electrical specification

Symbol	Description	Min.	Typ.	Max.	Unit
VFS _{V_{BAT}}	Full scale voltage for VBAT measurement		5.0		V
V _{BAT} ACCUR	Accuracy of the VBAT measurement (3 V < V _{BAT} < 4.5V)	-1		+1	%
VFS _{V_{BUS}}	Full scale voltage for VBUS measurement		7.5		V
V _{BUS} ACCUR	Accuracy of the VBUS measurement		1.5		%
VFS _{V_{SYS}}	Full scale voltage for V _{SYS} measurement		6.375		V
V _{SYS} ACCUR	Accuracy of the V _{SYS} measurement		1.5		%
C _{BAT} NTC	Capacitance in parallel with the thermistor	0		100	pF
VFS _{TEMP}	Full scale for battery and die temperature measurements		1.5		V
t _{CONV}	Conversion time		250		μs
DNL	Differential non-linearity		< 0.5		LSB

Table 29: System Monitor electrical specification

7.1.10 Registers

Instances

Instance	Base address	Description
ADC	0x00000500	SAADC registers ADC register map

Register overview

Register	Offset	Description
TASKVBATMEASURE	0x0	Task Take VBAT measurement
TASKNTCMEASURE	0x1	Task Take NTC measurement
TASKTEMPMEASURE	0x2	Task Take Die Temperature measurement
TASKV _{SYS} MEASURE	0x3	Task Take V _{SYS} measurement
TASKIBATMEASURE	0x6	Task Take IBAT measurement
TASKVBUS7MEASURE	0x7	Task Take VBUS 7V range measurement
TASKDELAYEDVBATMEASURE	0x8	Task Take delayed VBAT measurement
ADCCONFIG	0x9	ADC Configuration
ADCNTCRSEL	0xA	Select Battery NTC register
ADCAUTOTIMCONF	0xB	Auto measurement intervals
TASKAUTOTIMUPDATE	0xC	update toggle for NTC and Die temp AutoTime register bits
ADCDELTIMCONF	0xD	Vbat Delay timer control
ADCIBATMEASSTATUS	0x10	Battery current measurement status
ADCVBATRESULTMSB	0x11	ADC VBAT measurement result MSB

Register	Offset	Description
ADCNTCRESULTMSB	0x12	ADC NTC measurement result MSB
ADCTEMPRESULTMSB	0x13	ADC DIE TEMP measurement result MSB
ADCVSYSRESULTMSB	0x14	ADC VSYS measurement result MSB
ADCGPORESULTLSBS	0x15	ADC result LSB's (Vbat, Ntc, Temp and Vsys)
ADCVBAT0RESULTMSB	0x16	ADC VBAT0 Burst measurement result MSB
ADCVBAT1RESULTMSB	0x17	ADC VBAT1 Burst measurement result MSB
ADCVBAT2RESULTMSB	0x18	ADC VBAT2 Burst measurement result MSB
ADCVBAT3RESULTMSB	0x19	ADC VBAT3 Burst or VBUS measurement result MSB
ADCGP1RESULTLSBS	0x1A	ADC result LSB's (Vbat_burst0, 1, 2 and 3)
ADCIBATMEASEN	0x24	Enable auto IBAT measurement

7.1.10.1 TASKVBATMEASURE

Address offset: 0x0

Task Take VBAT measurement

Bit number						7	6	5	4	3	2	1	0
ID						A							
Reset 0x00						0 0 0 0 0 0 0 0							
ID	R/W	Field	Value ID	Value	Description								
A	W	TASKVBATMEASURE			Start VBAT Measurement								
			NOEFFECT	0	no effect								
			TRIGGER	1	Trigger task								

7.1.10.2 TASKNTCMEASURE

Address offset: 0x1

Task Take NTC measurement

Bit number						7	6	5	4	3	2	1	0
ID						A							
Reset 0x00						0 0 0 0 0 0 0 0							
ID	R/W	Field	Value ID	Value	Description								
A	W	TASKNTCMEASURE			Start Battery NTC thermistor Measurement								
			NOEFFECT	0	no effect								
			TRIGGER	1	Trigger task								

7.1.10.3 TASKTEMPMEASURE

Address offset: 0x2

Task Take Die Temperature measurement

Bit number						7	6	5	4	3	2	1	0
ID						A							
Reset 0x00						0 0 0 0 0 0 0 0							
ID	R/W	Field	Value ID	Value	Description								
A	W	TASKTEMPMEASURE			Start Die Temperature Measurement								
			NOEFFECT	0	no effect								
			TRIGGER	1	Trigger task								

7.1.10.4 TASKVSYMEASURE

Address offset: 0x3

Task Take VSYS measurement

Bit number	7	6	5	4	3	2	1	0
ID								A
Reset 0x00	0	0	0	0	0	0	0	0
ID	R/W	Field	Value ID	Value	Description			
A	W	TASKVSYMEASURE			Start VSYS Measurement			
			NOEFFECT	0	no effect			
			TRIGGER	1	Trigger task			

7.1.10.5 TASKIBATMEASURE

Address offset: 0x6

Task Take IBATmeasurement

Bit number	7	6	5	4	3	2	1	0
ID								A
Reset 0x00	0	0	0	0	0	0	0	0
ID	R/W	Field	Value ID	Value	Description			
A	W	TASKIBATMEASURE			Start IBAT Measurement			
			NOEFFECT	0	no effect			
			TRIGGER	1	Trigger task			

7.1.10.6 TASKVBUS7MEASURE

Address offset: 0x7

Task Take VBUS 7V range measurement

Bit number	7	6	5	4	3	2	1	0
ID								A
Reset 0x00	0	0	0	0	0	0	0	0
ID	R/W	Field	Value ID	Value	Description			
A	W	TASKVBUS7MEASURE			Start VBUS 7Volt range Measurement			
			NOEFFECT	0	no effect			
			TRIGGER	1	Trigger task			

7.1.10.7 TASKDELAYEDVBATMEASURE

Address offset: 0x8

Task Take delayed VBAT measurement

Bit number	7	6	5	4	3	2	1	0
ID								A
Reset 0x00	0	0	0	0	0	0	0	0
ID	R/W	Field	Value ID	Value	Description			
A	W	TASKDLYVBATMEASURE			Start delayed VBAT Measurement			
			NOEFFECT	0	no effect			
			TRIGGER	1	Trigger task			

7.1.10.8 ADCCONFIG

Address offset: 0x9

ADC Configuration

Bit number						7	6	5	4	3	2	1	0
ID												B	A
Reset 0x00						0						0	0
ID	R/W	Field	Value ID	Value	Description								
A	RW	VBATAUTOENABLE			Enable VBAT Auto measurement every 1 Second								
			NOAUTO	0	Single measurement when triggered								
			AUTOENABLE	1	Make measurement every 1s								
B	RW	VBATBURSTENABLE			Enable VBAT Burst mode VBAT0, VBAT1, VBAT2, VBAT3								
			SINGLEMODE	0	Make a Single measurement								
			BURSTMODE	1	Make 4 consecutive measurements								

7.1.10.9 ADCNTRSEL

Address offset: 0xA

Select Battery NTC register

Bit number						7	6	5	4	3	2	1	0
ID												A	A
Reset 0x01						0						0	1
ID	R/W	Field	Value ID	Value	Description								
A	RW	ADCNTRSEL			Select value and TRIM to match Battery NTC resistance								
			Hi_Z	0	No thermistor								
			10K	1	NTC10K								
			47K	2	NTC47K								
			100K	3	NTC100K								

7.1.10.10 ADCAUTOTIMCONF

Address offset: 0xB

Auto measurement intervals

Bit number						7	6	5	4	3	2	1	0		
ID												B	B	A	A
Reset 0x03						0						0	0	0	1
ID	R/W	Field	Value ID	Value	Description										
A	RW	NTCAUTOTIM			NTC thermistor measurement interval during Charging										
			4MS	0	4ms										
			64MS	1	64ms										
			128MS	2	128ms										
			1024MS	3	1024ms										
B	RW	TEMPAUTOTIM			Die Temp measurement interval during Charging										
			4MS	0	4ms										
			8MS	1	8ms										
			16MS	2	16ms										
			32MS	3	32ms										

7.1.10.11 TASKAUTOTIMUPDATE

Address offset: 0xC

update toggle for NTC and Die temp AutoTime register bits

Bit number		7 6 5 4 3 2 1 0						
ID								A
Reset 0x00								0 0 0 0 0 0 0 0
ID	R/W	Field	Value ID	Value	Description			
A	W	TASKAUTOTIMUPDATE			update toggle, handshake signal to flag NtcAutoTim and TempAutoTim change			
			NOEFFECT	0	no effect			
			UPDATEAUTOTIM	1	Register new NtcAutoTim, TempAutoTim value			

7.1.10.12 ADCDELTIMCONF

Address offset: 0xD

Vbat Delay timer control

Bit number		7 6 5 4 3 2 1 0					
ID		A A A A A A A A					
Reset 0x00		0 0 0 0 0 0 0 0					
ID	R/W	Field	Value ID	Value	Description		
A	RW	VBATDELTIM			Delayed Vbat measurement control 4ms(value 0) to 514ms(value 255) and the step size is 2ms.		

7.1.10.13 ADCIBATMEASSTATUS

Address offset: 0x10

Battery current measurement status

Bit number		7 6 5 4 3 2 1 0					
ID		C B B A A					
Reset 0x00		0 0 0 0 0 0 0 0					
ID	R/W	Field	Value ID	Value	Description		
A	R	BCHARGERICHARGE			Battery current charge		
B	R	BCHARGERMODE			Battery charger mode		
C	R	IBATMEASEINVALID			Ibat measurement Invalid flag		

7.1.10.14 ADCVBATRESULTMSB

Address offset: 0x11

ADC VBAT measurement result MSB

Bit number		7 6 5 4 3 2 1 0					
ID		A A A A A A A A					
Reset 0x00		0 0 0 0 0 0 0 0					
ID	R/W	Field	Value ID	Value	Description		
A	R	VBATRESULTMSB			ADC VBAT measurement result upper 8-bits		

7.1.10.15 ADCNTCRESULTMSB

Address offset: 0x12

ADC NTC measurement result MSB

Bit number	7	6	5	4	3	2	1	0
ID	A	A	A	A	A	A	A	A
Reset 0x00	0	0	0	0	0	0	0	0
ID	R/W	Field	Value ID	Value	Description			
A	R	NTCRESULTMSB			ADC NTC thermistor Battery measurement result upper 8-bits			

7.1.10.16 ADCTEMPRESULTMSB

Address offset: 0x13

ADC DIE TEMP measurement result MSB

Bit number	7	6	5	4	3	2	1	0
ID	A	A	A	A	A	A	A	A
Reset 0x00	0	0	0	0	0	0	0	0
ID	R/W	Field	Value ID	Value	Description			
A	R	TEMPRESULTMSB			ADC Die Temperature measurement result upper 8-bits			

7.1.10.17 ADCVSYRESULTMSB

Address offset: 0x14

ADC VSYS measurement result MSB

Bit number	7	6	5	4	3	2	1	0
ID	A	A	A	A	A	A	A	A
Reset 0x00	0	0	0	0	0	0	0	0
ID	R/W	Field	Value ID	Value	Description			
A	R	VSYRESULTMSB			ADC VSYS measurement result upper 8-bits			

7.1.10.18 ADCGPORESULTLSBS

Address offset: 0x15

ADC result LSB's (Vbat, Ntc, Temp and Vsys)

Bit number	7	6	5	4	3	2	1	0
ID	D	D	C	C	B	B	A	A
Reset 0x00	0	0	0	0	0	0	0	0
ID	R/W	Field	Value ID	Value	Description			
A	R	VBATRESULTLSB			VBAT measurement result LSBs			
B	R	NTCRESULTLSB			Battery NTC thermistor measurement result LSBs			
C	R	TEMPRESULTLSB			Die Temperature measurement result LSBs			
D	R	VSYRESULTLSB			VSYS measurement result LSBs			

7.1.10.19 ADCVBATORESULTMSB

Address offset: 0x16

ADC VBAT0 Burst measurement result MSB

Bit number	7	6	5	4	3	2	1	0
ID	A	A	A	A	A	A	A	A
Reset 0x00	0	0	0	0	0	0	0	0
ID	R/W	Field	Value ID	Value	Description			
A	R	VBAT0RESULTMSB			ADC VBAT0 Burst measurement result upper 8-bits			

7.1.10.20 ADCVBAT1RESULTMSB

Address offset: 0x17

ADC VBAT1 Burst measurement result MSB

Bit number	7	6	5	4	3	2	1	0
ID	A	A	A	A	A	A	A	A
Reset 0x00	0	0	0	0	0	0	0	0
ID	R/W	Field	Value ID	Value	Description			
A	R	VBAT1RESULTMSB			ADC VBAT1 Burst measurement result upper 8-bits			

7.1.10.21 ADCVBAT2RESULTMSB

Address offset: 0x18

ADC VBAT2 Burst measurement result MSB

Bit number	7	6	5	4	3	2	1	0
ID	A	A	A	A	A	A	A	A
Reset 0x00	0	0	0	0	0	0	0	0
ID	R/W	Field	Value ID	Value	Description			
A	R	VBAT2RESULTMSB			ADC VBAT2 Burst measurement result upper 8-bits			

7.1.10.22 ADCVBAT3RESULTMSB

Address offset: 0x19

ADC VBAT3 Burst or VBUS measurement result MSB

Bit number	7	6	5	4	3	2	1	0
ID	A	A	A	A	A	A	A	A
Reset 0x00	0	0	0	0	0	0	0	0
ID	R/W	Field	Value ID	Value	Description			
A	R	VBAT3RESULTMSB			If TASK_VBAT_MEASURE is triggered in BURST mode, this register will contain ADC VBAT3 Burst measurement result upper 8-bits If TASK_VBUS7_MEASURE is triggered, this register will contain VBUS measurement result upper 8-bits			

7.1.10.23 ADCGP1RESULTLSBS

Address offset: 0x1A

ADC result LSB's (Vbat_burst0, 1, 2 and 3)

Bit number							7	6	5	4	3	2	1	0	
ID							D	D	C	C	B	B	A	A	
Reset 0x00							0	0	0	0	0	0	0	0	0
ID	R/W	Field	Value ID	Value	Description										
A	R	VBAT0RESULTLSB			Burst VBAT0 measurement result LSBs										
B	R	VBAT1RESULTLSB			Burst VBAT1 measurement result LSBs										
C	R	VBAT2RESULTLSB			Burst VBAT2 measurement result LSBs										
D	R	VBAT3RESULTLSB			Burst VBAT3 measurement result LSBs										

7.1.10.24 ADCIBATMEASEN

Address offset: 0x24

Enable auto IBAT measurement

Bit number							7	6	5	4	3	2	1	0	
ID															A
Reset 0x00							0	0	0	0	0	0	0	0	0
ID	R/W	Field	Value ID	Value	Description										
A	RW	IBATMEASENABLE			Enable Auto IBAT measurement after VBAT task										

7.2 POF — Power-fail comparator

The power-fail comparator (POF) provides the host with an early warning of an impending power supply failure.

POF is generated from an always active comparator monitoring the voltage on the **VSYS** pin. It can be configured through **POFCONFIG** on page 110 to give a warning through a GPIO to the host.

If voltage on the **VSYS** pin drops below $VSYS_{COMP}$, but voltage remains above the respective BOR threshold on the **VBAT** or **VBUS** pins, the **VSYS** pin is disabled after $t_{POFWAIT}$ and registers are reset after t_{PWRDN} . If $VSYS > VSYS_{COMP}$, the chip powers up after t_{PWRDN} . See [Power fail warning](#) on page 109.

Note: Before setting $VSYS_{POF}$, voltage on the **VSYS** pin must be higher than the selected threshold or it triggers a POF event and resets the device. $VSYS_{POF}$ must be set to a higher voltage than the battery undervoltage protection level to avoid triggering the protection circuit. The POF threshold is also reset to the default setting. When $VSYS > VSYS_{COMP}$, BUCK may start up again depending on **VSET [n]** pin configuration.

A warning is issued in the following cases:

- VBUS is removed while the battery is empty or not connected ($VBAT < VSYS_{POF}$)
- VBUS rises above $VBUS_{OVP}$ while the battery is empty or not connected ($VBAT < VSYS_{POF}$)
- The battery is removed when VBUS is not connected
- The battery discharges until $VBAT < VSYS_{POF}$ and VBUS is not connected
- Battery voltage drops momentarily below $VSYS_{POF}$ and VBUS is not connected

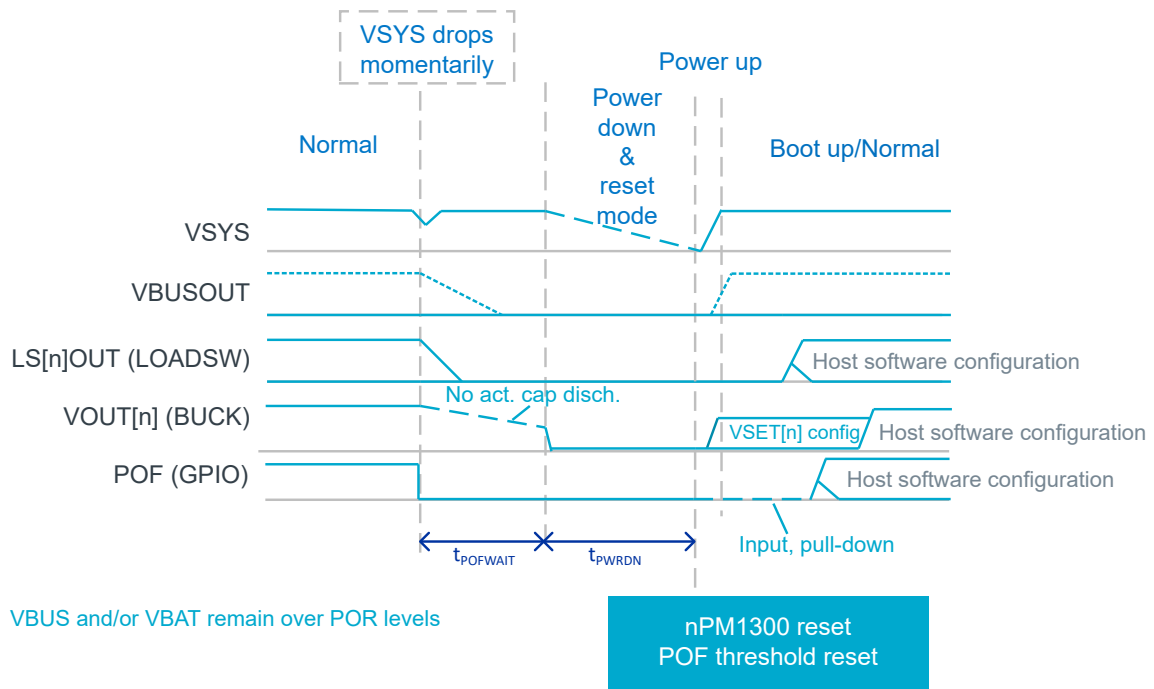

VBUS and/or VBAT remain over POR levels

Figure 42: Power fail warning

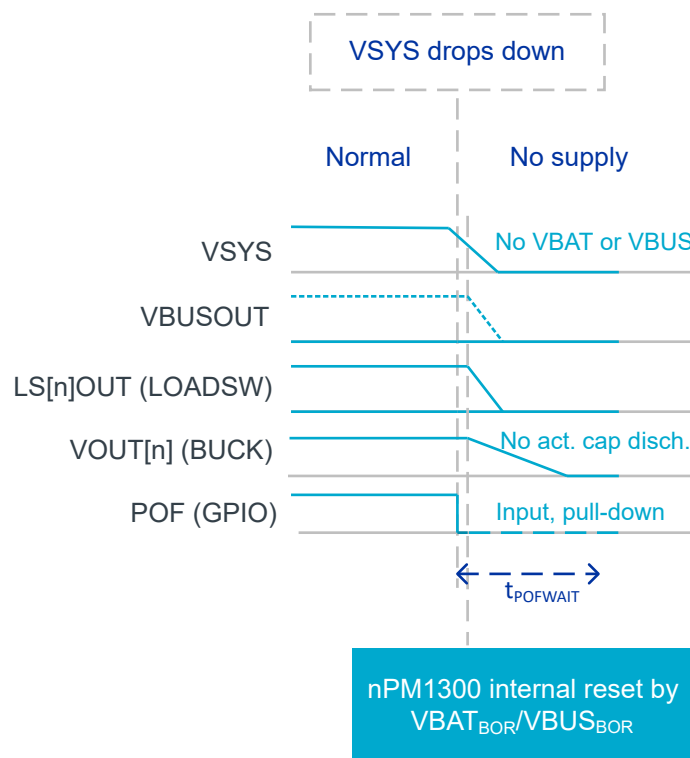

Figure 43: Power removal

To use the POF warning feature, set POFWARNPOLARITY and POFENA to 1 in register [POFCONFIG](#) on page 110. GPIO settings are located in [GPIO — General purpose input/output](#) on page 84.

7.2.1 Electrical specification

Symbol	Description	Min.	Typ.	Max.	Unit
POF	VSYS _{POF} rising threshold, default Always 100 mV (typ.) above the falling threshold		2.9		V
VSYS _{POF}	Minimum setting VSYS _{POF} falling threshold		2.6		V
VSYS _{POF}	Default setting VSYS _{POF} falling threshold		2.8		V
VSYS _{POF}	Maximum setting VSYS _{POF} falling threshold		3.5		V
t _{POF}	Reaction time (from crossing the threshold to edge on the warning signal)		1		ms
t _{PWRDN}	Time in power-down mode		100		ms
t _{POFWAIT}	Delay before enabling the active output capacitor discharge and disconnecting V_{BAT} and V_{BUS} from VSYS		30		ms

Table 30: POF electrical specification

7.2.2 Registers

Instances

Instance	Base address	Description
POF	0x00000900	POF registers POF register map

Register overview

Register	Offset	Description
POFCONFIG	0x0	Power Failure Detection block configuration

7.2.2.1 POFCONFIG

Address offset: 0x0

Power Failure Detection block configuration

Bit number						7	6	5	4	3	2	1	0		
ID										C	C	C	C	B	A
Reset 0x00						0	0	0	0	0	0	0	0	0	
ID	R/W	Field	Value ID	Value	Description										
A	RW	POFENA			Enable Power Failure feature										
			OFF	0	Off										
			ENABLED	1	WarningEnabled										
B	RW	POFWARNPOLARITY			Power Failure Warning polarity										
			LOACTIVE	0	Active Low										
			HIACTIVE	1	Active Hi										
C	RW	POFVSYSTHRESHSEL			VSYS Comparator Threshold Select										
			2V8	0	2.8V										

Bit number						7	6	5	4	3	2	1	0
ID						C C C C B A							
Reset 0x00						0	0	0	0	0	0	0	0
ID	R/W	Field	Value ID	Value	Description								
			2V6	1	2.6V								
			2V7	2	2.7V								
			2V9	3	2.9V								
			3V0	4	3.0V								
			3V1	5	3.1V								
			3V2	6	3.2V								
			3V3	7	3.3V								
			3V4	8	3.4V								
			3V5	9	3.5V								
			unused10	10	set to 2.8V								
			unused11	11	set to 2.8V								
			unused12	12	set to 2.8V								
			unused13	13	set to 2.8V								
			unused14	14	set to 2.8V								
			unused15	15	set to 2.8V								

7.3 TIMER — Timer/monitor

TIMER can be used in the following ways, depending on configuration.

- Boot monitor
- Watchdog timer
- Wake-up timer
- General purpose timer

TIMER is a 24-bit timer running at the frequency of the timer clock, f_{TIMER} , and has a prescaler.

TIMER only runs one configuration at a time because it is shared for all functions. The wake-up timer wakes the system at a programmable interval when the device is in Hibernate mode. Do not use the watchdog timer or general purpose timer when the system is in Ship or Hibernate mode.

TIMER is controlled by register [TIMERCONFIG](#) on page 115. The start value is configured with [TIMERHIBYTE](#) on page 116, [TIMERMIDBYTE](#) on page 116, and [TIMERLOBYTE](#) on page 117. The settings are applied with [TIMERTARGETSTROBE](#) on page 115. TIMER is started with [TIMERSET](#) on page 114 and is stopped with [TIMERCLR](#) on page 115.

Example settings are shown in the following table.

f_{TIMER}	TIMERHIBYTE	TIMERMIDBYTE	TIMERLOBYTE	Time
2 ms	0	0	250	0.5 s
16 ms	0	0	250	4 s
16 ms	0	1	0	4.096 s
16 ms	1	0	0	1048.576 s
16 ms	255	255	255	74.5 h

Table 31: Example timer register settings

7.3.1 Boot monitor

After a power-on reset, the default timer is boot monitor and this is disabled. When enabled, it allows an automatic power cycle if the host does not set bit `TASK.TIMER.DIS` within t_{BOOT} .

Host software can enable the boot monitor with bit `BOOT.TIMER.EN`. It can disable the boot monitor to prevent interference with firmware updates. When enabled, the boot monitor remains enabled even if the chip is reset, except for a power-on reset. Removing both `VBAT` and `VBUS`, or clearing the `BOOT.TIMER.EN` bit, deactivates the timer during the next power-up.

7.3.2 Watchdog timer

Watchdog timer expiration can be configured by host software to generate an `NRESETOUT` through a GPIO or a power cycle.

Power cycle means internally disconnecting `VSYS` from `VBAT` and `VBUS`. `BUCK` and `LOADSW` are actively pulled low for 100 ms. The device is reset and `BUCK` is re-enabled. Active pull-downs are present at pin `VOUT1`, `VOUT2`, `LSOUT1`, and `LS2OUT2` during t_{PWRDN} .

The watchdog timer can issue a pre-warning interrupt, $t_{PREWARN}$, before expiration. The reset pulse, which is active-low, through the `NRESETOUT` GPIO lasts for t_{RESET} . Watchdog can be configured in register `WATCHDOGKICK` on page 115.

The pre-warning interrupt is generated one cycle of the selected prescaler, either 2 ms or 16 ms, before expiry of the watchdog occurs.

The following figure shows a watchdog reset where the nPM1300 device is not reset internally.

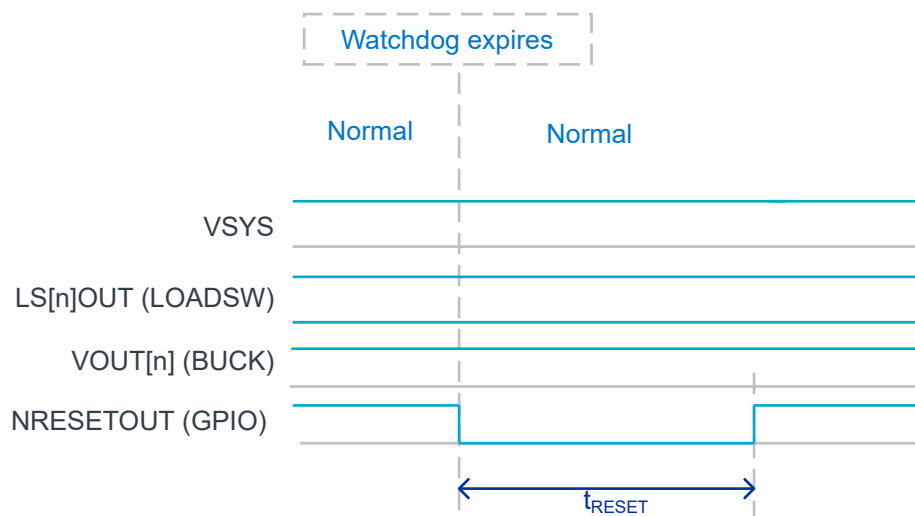

Figure 44: Watchdog reset

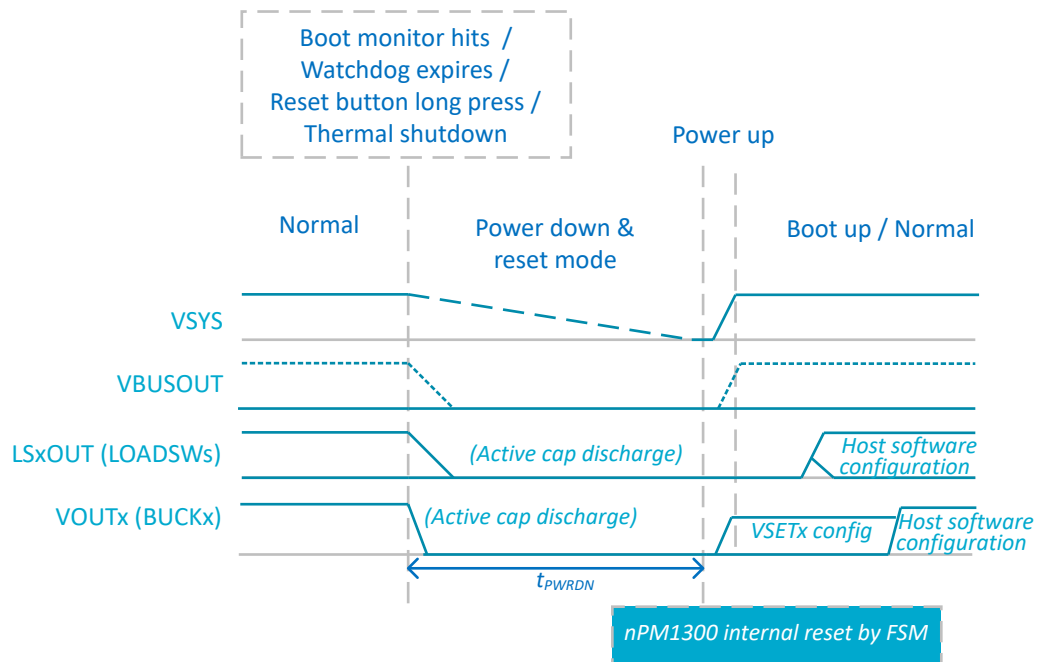

Figure 45: Power cycle

Note: For the thermal shutdown case, t_{PWRDN} will be longer as it waits for the die temperature to cool down below $TSD - TSD_{HYST}$.

7.3.3 Wake-up timer

The wake-up timer wakes the system from Hibernate mode.

Host software configures the timer before the device enters Hibernate mode, see [Ship and Hibernate modes](#) on page 117.

7.3.4 General purpose timer

The general purpose timer interrupts the host after a timeout with the WATCHDOG.WARNING event.

Prescaler is configured in register [TIMERCONFIG](#) on page 115 with the default set to 16 ms.

When the prescaler is configured to 16 ms in [TIMERCONFIG](#) on page 115 and [TIMERHIBYTE](#) on page 116 is 5, [TIMERMIDBYTE](#) on page 116 is 2 and [TIMERLOBYTE](#) on page 117 is 1, then the general purpose timer will wake after 5251 seconds.

7.3.5 Electrical specification

Both prescaler settings 16 ms and (2 ms) are included. Values in parenthesis are for the 2 ms prescaler.

Symbol	Description	Min.	Typ.	Max.	Unit
f_{TIMER}	Frequency of timer clock		64 (512)		Hz
t_{PREWARN}	Time between watchdog timer interrupt and reset/power cycle		16 (2)		ms
$t_{\text{PER_MIN}}$	Minimum time period		16 (2)		ms
$t_{\text{PER_MAX}}$	Maximum time period		3 (9)		days (hours)
t_{BOOT}	Amount of time before a power cycle is performed when no traffic is observed on TWI and BOOT.TIMER.EN is set		10		s
t_{PWRDN}	Length of power cycle		100		ms
t_{RESET}	Length of reset pulse		100		ms
f_{ACCUR}	Accuracy of timer clock		3		%

Table 32: TIMER electrical specification

7.3.6 Registers

Instances

Instance	Base address	Description
TIMER	0x00000700	TIMER registers TIMER register map

Register overview

Register	Offset	Description
TIMERSET	0x0	Start Timer
TIMERCLR	0x1	Stop Timer
TIMERTARGETSTROBE	0x3	Strobe for timer Target
WATCHDOGKICK	0x4	Watchdog kick
TIMERCONFIG	0x5	Timer mode selection
TIMERSTATUS	0x6	Timers Status
TIMERHIBYTE	0x8	Timer Most Significant Byte
TIMERMIDBYTE	0x9	Timer Middle Byte
TIMERLOBYTE	0xA	Timer Least Significant Byte

7.3.6.1 TIMERSET

Address offset: 0x0

Start Timer

Bit number						7	6	5	4	3	2	1	0							
ID													A							
Reset 0x00													0	0	0	0	0	0	0	0
ID	R/W	Field	Value ID	Value	Description															
A	W	TASKTIMEREN			Start Timer															
			NOEFFECT	0	no effect															
			SET	1	Timer Start request															

7.3.6.2 TIMERCLR

Address offset: 0x1

Stop Timer

Bit number						7	6	5	4	3	2	1	0						
ID													A						
Reset 0x00													0	0	0	0	0	0	0
ID	R/W	Field	Value ID	Value	Description														
A	W	TASKTIMERDIS			Stop Timer														
			NOEFFECT	0	no effect														
			SET	1	Timer Stop request														

7.3.6.3 TIMERTARGETSTROBE

Address offset: 0x3

Strobe for timer Target

Bit number						7	6	5	4	3	2	1	0						
ID													A						
Reset 0x00													0	0	0	0	0	0	0
ID	R/W	Field	Value ID	Value	Description														
A	W	TASKTIMERTARGETSTROBE			Timer target strobe														
			NOEFFECT	0	no effect														
			SET	1	load timer target (24 bit timer val)														

7.3.6.4 WATCHDOGKICK

Address offset: 0x4

Watchdog kick

Bit number						7	6	5	4	3	2	1	0						
ID													A						
Reset 0x00													0	0	0	0	0	0	0
ID	R/W	Field	Value ID	Value	Description														
A	W	TASKWATCHDOGKICK			Watchdog kick														
			NOEFFECT	0	no effect														
			Kick	1	kick watchdog														

7.3.6.5 TIMERCONFIG

Address offset: 0x5

Timer mode selection

Bit number						7	6	5	4	3	2	1	0
ID						B A A A							
Reset 0x00						0 0 0 0 0 0 0 0							
ID	R/W	Field	Value ID	Value	Description								
A	RW	TIMERMODESEL			Select Watchdog and timer modes								
			BOOTMONITOR	0	Boot Monitor								
			WATCHDOGWARNING	1	Watchdog Warning								
			WATCHDOGRESET	2	Watchdog Reset								
			GENPURPOSETIMER	3	GenPurpose Timer								
			WAKEUPTIMER	4	Wakeup Timer								
B	RW	TIMERPRESCALER			Switches between 16ms and 2ms Timer Prescale								
			SLOW	0	16ms Prescale								
			FAST	1	2ms Prescale								

7.3.6.6 TIMERSTATUS

Address offset: 0x6

Timers Status

Bit number						7	6	5	4	3	2	1	0
ID						B A							
Reset 0x00						0 0 0 0 0 0 0 0							
ID	R/W	Field	Value ID	Value	Description								
A	R	BOOTMONITORACTIVE			BootMonitor Active								
			INACTIVE	0	Boot Monitor not running								
			ACTIVE	1	BootMonitor running								
B	R	SLOWDOMAINCONFIGURED			SlowDomain Configured								
			NOTCONFIG	0	Not configured								
			CONFIG	1	Timers configured								

7.3.6.7 TIMERHIBYTE

Address offset: 0x8

Timer Most Significant Byte

Bit number						7	6	5	4	3	2	1	0
ID						A A A A A A A A							
Reset 0x00						0 0 0 0 0 0 0 0							
ID	R/W	Field	Value ID	Value	Description								
A	RW	TIMERHIBYTE			Timer Most Significant Byte of 3								

7.3.6.8 TIMERMIDBYTE

Address offset: 0x9

Timer Middle Byte

Bit number						7	6	5	4	3	2	1	0
ID						A A A A A A A A							
Reset 0x00						0 0 0 0 0 0 0 0							
ID	R/W	Field	Value ID	Value	Description								
A	RW	TIMERMIDBYTE			Timer Middle Byte of 3								

7.3.6.9 TIMERLOBYTE

Address offset: 0xA

Timer Least Significant Byte

Bit number	7	6	5	4	3	2	1	0
ID	A	A	A	A	A	A	A	A
Reset 0x00	0	0	0	0	0	0	0	0
ID	R/W	Field	Value ID	Value	Description			
A	RW	TIMERLOBYTE			Timer Least Significant Byte of 3			

7.4 Ship and Hibernate modes

Ship and Hibernate modes isolate the battery from the system and minimize the quiescent current.

Hibernate mode is identical to Ship mode with the exception that, in Hibernate mode, the timer is running and functions as an additional wake-up source.

The device enters Ship mode through register [TASKENTERSHIPMODE](#) on page 119. Register [SHPHLDCONFIG](#) on page 119 configures the **SHPHLD** button press time, and register [TASKSHPHLDCFGSTROBE](#) on page 119 applies the configured value. When VBUS is not present, the device enters Ship mode immediately. The host software must wait until [EVENTSVBUSIN0SET](#) on page 136 to ensure VBUS is disconnected and discharged before writing to the register.

The device enters Hibernate mode through register [TASKENTERHIBERNATE](#) on page 118. The host software must wait until [EVENTSVBUSIN0SET](#) on page 136 to ensure VBUS is disconnected and discharged before writing to the register. To apply the timer value, registers [TIMERHIBYTE](#) on page 116, [TIMERMIDBYTE](#) on page 116, and [TIMERLOBYTE](#) on page 117 must be configured before register [TIMERTARGETSTROBE](#) on page 115. In Hibernate mode, the quiescent current is higher compared to Ship mode because the low-power timer is running.

Exiting Hibernate mode using a button press must be configured in register [SHPHLDCONFIG](#) on page 119 and [TASKSHPHLDCFGSTROBE](#) on page 119.

When entering Ship mode, BUCK can be configured to discharge by enabling their pull downs, see [BUCKCTRL0](#) on page 70.

Note: [SHPHLDCONFIG](#) on page 119 and [TASKSHPHLDCFGSTROBE](#) on page 119 must be set before entering either Ship or Hibernate modes.

The following are alternative ways to exit Ship and Hibernate modes.

- Pulling pin SHPHLD low for a minimum period of $t_{\text{shipToActive}}$ (see [SHPHLDCONFIG](#) on page 119). A push button to GND is required.
- Applying a voltage on VBUS > V_{BUSPOR} .
- Exiting automatically through the Wake-up timer (only from Hibernate mode).

7.4.1 Electrical specification

Symbol	Description	Min.	Typ.	Max.	Unit
$t_{\text{ShipToActive}}$	Duration SHPHLD pin must be held low to exit Ship or Hibernate mode		16 32 64 96 (default) 304 608 1008 3008		ms
t_{RESETBUT}	Amount of time for a button press to cause a power cycle		10		s
R_{SHPHLD}	Pull-up resistor on SHPHLD pin		50		k Ω

Table 33: Ship mode electrical specification

7.4.2 Registers

Instances

Instance	Base address	Description
SHIP	0x00000B00	SHIP registers SHPHLD register map

Register overview

Register	Offset	Description
TASKENTERHIBERNATE	0x0	Task Enter Hibernate
TASKSHPHLDCFGSTROBE	0x1	Task Ship Hold config
TASKENTERSHIPMODE	0x2	Task enter ShipMode
TASKRESETCFG	0x3	Request reset config
SHPHLDCONFIG	0x4	Ship Hold button press timer config
SHPHLDSTATUS	0x5	Status of the SHPHLD pin
LPRESETCONFIG	0x6	Long press reset config register

7.4.2.1 TASKENTERHIBERNATE

Address offset: 0x0

Task Enter Hibernate

Bit number						7	6	5	4	3	2	1	0								
ID													A								
Reset 0x00													0	0	0	0	0	0	0	0	0
ID	R/W	Field	Value ID	Value	Description																
A	W	TASKENTERHIBERNATE			Enter Hibernate (Shipmode with Wakeup Timer)																
			NOEFFECT	0	no effect																
			TRIGGER	1	trigger task																

7.4.2.2 TASKSHPHLDCFGSTROBE

Address offset: 0x1

Task Ship Hold config

Bit number						7	6	5	4	3	2	1	0							
ID													A							
Reset 0x00													0	0	0	0	0	0	0	0
ID	R/W	Field	Value ID	Value	Description															
A	W	TASKSHPHLDCONFIGSTROBE			Load the SHPHLD Config															
			NOEFFECT	0	no effect															
			TRIGGER	1	strobe config															

7.4.2.3 TASKENTERSHIPMODE

Address offset: 0x2

Task enter ShipMode

Bit number						7	6	5	4	3	2	1	0							
ID													A							
Reset 0x00													0	0	0	0	0	0	0	0
ID	R/W	Field	Value ID	Value	Description															
A	W	TASKENTERSHIPMODE			Enter Shipmode (without Wakeup timer)															
			NOEFFECT	0	no effect															
			TRIGGER	1	trigger task															

7.4.2.4 TASKRESETCFG

Address offset: 0x3

Request reset config

Bit number						7	6	5	4	3	2	1	0							
ID													A							
Reset 0x00													0	0	0	0	0	0	0	0
ID	R/W	Field	Value ID	Value	Description															
A	W	TASKSHPHLDRSTCONFIG			Use to reset config settings															
			NOEFFECT	0	no effect															
			TRIGGER	1	reset															

7.4.2.5 SHPHLDCONFIG

Address offset: 0x4

Ship Hold button press timer config

Bit number						7	6	5	4	3	2	1	0						
ID												A	A	A					
Reset 0x03												0	0	0	0	0	0	1	1
ID	R/W	Field	Value ID	Value	Description														
A	RW	SHPHLDTIM			Ship-Hold press timer														
				16ms	0	16ms													
				32ms	1	32ms													
				64ms	2	64ms													
				96ms	3	96ms (default)													
				304ms	4	304ms													
				608ms	5	608ms													
				1008ms	6	1008ms													
	3008ms	7	3008ms																

7.4.2.6 SHPHLDSTATUS

Address offset: 0x5

Status of the SHPHLD pin

Bit number						7	6	5	4	3	2	1	0						
ID												A							
Reset 0x00												0	0	0	0	0	0	0	0
ID	R/W	Field	Value ID	Value	Description														
A	R	SHPHLDPINSTATUS			Ship Hold pin Status														
				LOW	0	Low													
				HIGH	1	High													

7.4.2.7 LPRESETCONFIG

Address offset: 0x6

Long press reset config register

Bit number						7	6	5	4	3	2	1	0						
ID												B	A						
Reset 0x00												0	0	0	0	0	0	0	0
ID	R/W	Field	Value ID	Value	Description														
A	RW	LONGTIMRESETDIS			Long press 10s timer enable														
				ENABLED	0	LongPress Enabled													
				DISABLED	1	Disabled													
B	RW	LONGTIMTWOBUTTONSEL			Select one (default) or two buttons to perform longpress reset														
				SHPHLD	0	SHPHLD													
				SHPHLDGPIO0	1	SHPHLD GPIO0													

7.5 RESET — Reset control

The **SHPHLD** pin is a reset control, in addition to being used for exiting Ship and Hibernate mode.

The **SHPHLD** pin has an internal pull-up resistor R_{SHPHLD} to VBAT or VBUS depending on which has the highest voltage. The functionality of the pin is determined by the device mode.

Normal operation

If configured, a short logic-low pulse on **SHPHLD** sends an interrupt to the host. Host software reads the pin state in register [SHPHLDSTATUS](#) on page 120.

A long logic-low ($> t_{\text{RESETBUT}}$) on **SHPHLD** causes a power cycle and resets the whole system. This feature is enabled by default after power-up, but can be disabled by the host software. See register [LPRESETCONFIG](#) on page 120 for more information.

Ship and Hibernate modes

When a logic-low occurs for longer than $t_{\text{ShipToActive}}$, the device wakes up from Ship or Hibernate mode, performs an internal reset, and transitions to normal operation.

Two-button reset

A two-button reset is implemented by connecting one button to the **SHPHLD** pin and another button to **GPIO0**. This feature is enabled by setting [LPRESETCONFIG](#) on page 120, and then [TASKSHPHLD CFGSTROBE](#) on page 119 to apply the configured value. Pressing and holding both buttons for longer than t_{RESETBUT} starts a power cycle.

Host software reset

Host software can reset the device by writing the **TASKSWRESET** bit in register [TASKSWRESET](#) on page 123. As a consequence, a power cycle is performed. A reset is not possible in Ship or Hibernate mode.

Scratch registers, reason for reset

Only POR and **TASKCLRERRLOG** can initialize the context registers found at [SCRATCH\[n\]](#). The cause of the first reset is reported in register [RSTCAUSE](#) on page 146.

7.6 TWI — I²C compatible two-wire interface

TWI is a two-wire interface that controls and monitors the device state through registers.

Main Features

- I²C compatible up to 400 kHz
- TWI clock supports 100 kHz to 1 MHz

A GPIO pin can be set as an interrupt pin, see [GPIO — General purpose input/output](#) on page 84.

Interface supply

TWI is supplied by **VDDIO**. It is recommended to connect **VDDIO** to a BUCK output, **VOOUT1**, or **VOOUT2**. **VDDIO** must be present in all operating modes of the chip, except in Ship and Hibernate modes.

Addressing

The 7-bit slave address is 110 1011.

The registers have 16-bit addressing and 8-bit data. The upper address byte is the register instance base address (bank address). The lower byte is the offset within an instance (bank).

TO WRITE A REGISTER IN THE DEVICE

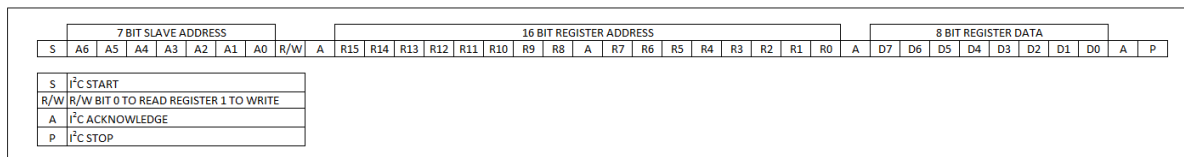

Figure 46: TWI write example

TO READ A REGISTER IN THE DEVICE

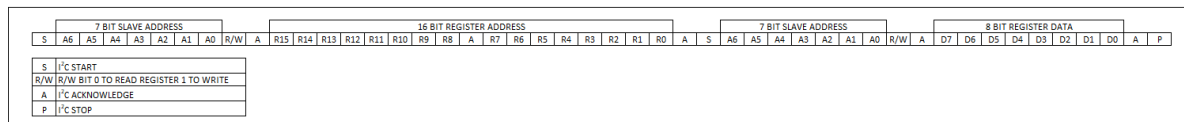

Figure 47: TWI read example

7.6.1 TWI timing diagram

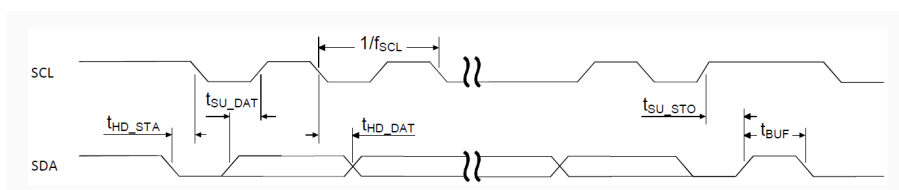

Figure 48: TWI timing diagram

7.6.2 Electrical specification

Symbol	Description	Min.	Typ.	Max.	Units
F_{SCL}	Bit rate for TWI	100		1000	kbps
TSU_{DAT}	Data setup time before positive edge on SCL, all modes	50			ns
THD_{DAT}	Data hold time after negative edge on SCL, all modes	0			ns
THD_{STA}	Hold time from for START condition (SDA low to SCL low), 100 kbps	260			ns
TSU_{STO}	Setup time from SCL high to STOP condition, 100 kbps	260			ns
TBUF	Bus free time between STOP and START conditions		500		ns

Table 34: TWI electrical specification

7.7 Event and interrupt registers

This section details the event and interrupt related registers.

7.7.1 Registers

Instances

Instance	Base address	Description
MAIN	0x00000000	MAIN registers MAIN Register map

Register overview

Register	Offset	Description
TASKSWRESET	0x1	Task Force a full reboot power-cycle
EVENTSADCSET	0x2	ADC Events Event Set
EVENTSADCCLR	0x3	ADC Events Event Clear
INTENEVENTSADCSET	0x4	ADC Events Interrupt Enable Set
INTENEVENTSADCCLR	0x5	ADC Events Interrupt Enable Clear
EVENTSBCHARGER0SET	0x6	Battery Charger Temperature Events Event Set
EVENTSBCHARGER0CLR	0x7	Battery Charger Temperature Events Event Clear
INTENEVENTSBCHARGER0SET	0x8	Battery Charger Temperature Events Interrupt Enable Set
INTENEVENTSBCHARGER0CLR	0x9	Battery Charger Temperature Events Interrupt Enable Clear
EVENTSBCHARGER1SET	0xA	Battery Charger Status Events Event Set
EVENTSBCHARGER1CLR	0xB	Battery Charger Status Events Event Clear
INTENEVENTSBCHARGER1SET	0xC	Battery Charger Status Events Interrupt Enable Set
INTENEVENTSBCHARGER1CLR	0xD	Battery Charger Status Events Interrupt Enable Clear
EVENTSBCHARGER2SET	0xE	Battery Charger Battery Events Event Set
EVENTSBCHARGER2CLR	0xF	Battery Charger Battery Events Event Clear
INTENEVENTSBCHARGER2SET	0x10	Battery Charger Battery Events Interrupt Enable Set
INTENEVENTSBCHARGER2CLR	0x11	Battery Charger Battery Events Interrupt Enable Clear
EVENTSSHPLDSET	0x12	ShipHold pin Events Event Set
EVENTSSHPLDCLR	0x13	ShipHold pin Events Event Clear
INTENEVENTSSHPLDSET	0x14	ShipHold pin Events Interrupt Enable Set
INTENEVENTSSHPLDCLR	0x15	ShipHold pin Events Interrupt Enable Clear
EVENTSVBUSIN0SET	0x16	VBUSIN Voltage Detection Events Event Set
EVENTSVBUSIN0CLR	0x17	VBUSIN Voltage Detection Events Event Clear
INTENEVENTSVBUSIN0SET	0x18	VBUSIN Voltage Detection Events Interrupt Enable Set
INTENEVENTSVBUSIN0CLR	0x19	VBUSIN Voltage Detection Events Interrupt Enable Clear
EVENTSVBUSIN1SET	0x1A	VBUSIN Thermal and USB Events Event Set
EVENTSVBUSIN1CLR	0x1B	VBUSIN Thermal and USB Events Event Clear
INTENEVENTSVBUSIN1SET	0x1C	VBUSIN Thermal and USB Events Interrupt Enable Set
INTENEVENTSVBUSIN1CLR	0x1D	VBUSIN Thermal and USB Events Interrupt Enable Clear
EVENTSGPIOSET	0x22	GPIO Event Event Set
EVENTSGPIOCLR	0x23	GPIO Event Event Clear
INTENEVENTSGPIOSET	0x24	GPIO Event Interrupt Enable Set
INTENEVENTSGPIOCLR	0x25	GPIO Event Interrupt Enable Clear

7.7.1.1 TASKSWRESET

Address offset: 0x1

Task Force a full reboot power-cycle

Bit number						7	6	5	4	3	2	1	0							
ID													A							
Reset 0x00													0	0	0	0	0	0	0	0
ID	R/W	Field	Value ID	Value	Description															
A	W	TASKSWRESET			Turn off all Supplies and apply internal reset															
			NOEFFECT	0	no effect															
			TRIGGER	1	Trigger task															

7.7.1.2 EVENTSADCSET

Address offset: 0x2

ADC Events Event Set

Bit number						7	6	5	4	3	2	1	0							
ID													H	G	F	E	D	C	B	A
Reset 0x00													0	0	0	0	0	0	0	0
ID	R/W	Field	Value ID	Value	Description															
A	RW	EVENTADCVBATRDY			VBAT measurement finished. Writing 1 sets the event (for debugging).															
		W1S																		
			LOW	0	low															
			HIGH	1	high															
B	RW	EVENTADCNTCRDY			Battery NTC measurement finished. Writing 1 sets the event (for debugging).															
		W1S																		
			LOW	0	low															
			HIGH	1	high															
C	RW	EVENTADCTEMPRDY			Internal Die Temperature measurement finished. Writing 1 sets the event (for debugging).															
		W1S																		
			LOW	0	low															
			HIGH	1	high															
D	RW	EVENTADCVSYSRDY			VSYS Voltage measurement measurement finished. Writing 1 sets the event (for debugging).															
		W1S																		
			LOW	0	low															
			HIGH	1	high															
E	RW	EVENTADCVSET1RDY			DCDC VSET1 pin measurement finished. Writing 1 sets the event (for debugging).															
		W1S																		
			LOW	0	low															
			HIGH	1	high															
F	RW	EVENTADCVSET2RDY			DCDC VSET2 pin measurement finished. Writing 1 sets the event (for debugging).															
		W1S																		
			LOW	0	low															
			HIGH	1	high															
G	RW	EVENTADCIBATRDY			IBAT measurement finished. Writing 1 sets the event (for debugging).															
		W1S																		
			LOW	0	low															
			HIGH	1	high															
H	RW	EVENTADCVBUS7V0RDY			VBUS (7Volt range) measurement finished. Writing 1 sets the event (for debugging).															
		W1S																		
			LOW	0	low															
			HIGH	1	high															

7.7.1.3 EVENTSADCCLR

Address offset: 0x3

ADC Events Event Clear

Bit number						7	6	5	4	3	2	1	0
ID						H	G	F	E	D	C	B	A
Reset 0x00						0	0	0	0	0	0	0	0
ID	R/W	Field	Value ID	Value	Description								
A	RW	EVENTADCVBATRDY W1C			VBAT measurement finished. Writing 1 clears the event (e.g. to acknowledge an interrupt).								
			LOW	0	low								
			HIGH	1	high								
B	RW	EVENTADCNTCRDY W1C			Battery NTC measurement finished. Writing 1 clears the event (e.g. to acknowledge an interrupt).								
			LOW	0	low								
			HIGH	1	high								
C	RW	EVENTADCTEMPRDY W1C			Internal Die Temperature measurement finished. Writing 1 clears the event (e.g. to acknowledge an interrupt).								
			LOW	0	low								
			HIGH	1	high								
D	RW	EVENTADCVSYSRDY W1C			VSYS Voltage measurement measurement finished. Writing 1 clears the event (e.g. to acknowledge an interrupt).								
			LOW	0	low								
			HIGH	1	high								
E	RW	EVENTADCSET1RDY W1C			DCDC VSET1 pin measurement finished. Writing 1 clears the event (e.g. to acknowledge an interrupt).								
			LOW	0	low								
			HIGH	1	high								
F	RW	EVENTADCSET2RDY W1C			DCDC VSET2 pin measurement finished. Writing 1 clears the event (e.g. to acknowledge an interrupt).								
			LOW	0	low								
			HIGH	1	high								
G	RW	EVENTADCIBATRDY W1C			IBAT measurement finished. Writing 1 clears the event (e.g. to acknowledge an interrupt).								
			LOW	0	low								
			HIGH	1	high								
H	RW	EVENTADCVBUS7V0RDY W1C			VBUS (7Volt range) measurement finished. Writing 1 clears the event (e.g. to acknowledge an interrupt).								
			LOW	0	low								
			HIGH	1	high								

7.7.1.4 INTENEVENTSADCSET

Address offset: 0x4

ADC Events Interrupt Enable Set

Bit number						7	6	5	4	3	2	1	0
ID						H	G	F	E	D	C	B	A
Reset 0x00						0	0	0	0	0	0	0	0
ID	R/W	Field	Value ID	Value	Description								
A	RW	EVENTADCVBATRDY W1S			Writing 1 enables interrupts from EVENTADCVBATRDY								
			LOW	0	low								
			HIGH	1	high								

Bit number						7	6	5	4	3	2	1	0
ID						H	G	F	E	D	C	B	A
Reset 0x00						0	0	0	0	0	0	0	0
ID	R/W	Field	Value ID	Value	Description								
B	RW	EVENTADCNTCRDY W1S			Writing 1 enables interrupts from EVENTADCNTCRDY								
			LOW	0	low								
			HIGH	1	high								
C	RW	EVENTADCTEMPRDY W1S			Writing 1 enables interrupts from EVENTADCTEMPRDY								
			LOW	0	low								
			HIGH	1	high								
D	RW	EVENTADCVSYSRDY W1S			Writing 1 enables interrupts from EVENTADCVSYSRDY								
			LOW	0	low								
			HIGH	1	high								
E	RW	EVENTADCVSET1RDY W1S			Writing 1 enables interrupts from EVENTADCVSET1RDY								
			LOW	0	low								
			HIGH	1	high								
F	RW	EVENTADCVSET2RDY W1S			Writing 1 enables interrupts from EVENTADCVSET2RDY								
			LOW	0	low								
			HIGH	1	high								
G	RW	EVENTADCIBATRDY W1S			Writing 1 enables interrupts from EVENTADCIBATRDY								
			LOW	0	low								
			HIGH	1	high								
H	RW	EVENTADCVBUS7V0RDY W1S			Writing 1 enables interrupts from EVENTADCVBUS7V0RDY								
			LOW	0	low								
			HIGH	1	high								

7.7.1.5 INTENEVENTSADCCLR

Address offset: 0x5

ADC Events Interrupt Enable Clear

Bit number						7	6	5	4	3	2	1	0
ID						H	G	F	E	D	C	B	A
Reset 0x00						0	0	0	0	0	0	0	0
ID	R/W	Field	Value ID	Value	Description								
A	RW	EVENTADCVBATRDY W1C			Writing 1 disables interrupts from EVENTADCVBATRDY								
			LOW	0	low								
			HIGH	1	high								
B	RW	EVENTADCNTCRDY W1C			Writing 1 disables interrupts from EVENTADCNTCRDY								
			LOW	0	low								
			HIGH	1	high								
C	RW	EVENTADCTEMPRDY W1C	LOW	0	Writing 1 disables interrupts from EVENTADCTEMPRDY								
					low								

Bit number						7	6	5	4	3	2	1	0
ID						H	G	F	E	D	C	B	A
Reset 0x00						0	0	0	0	0	0	0	0
ID	R/W	Field	Value ID	Value	Description								
			HIGH	1	high								
D	RW	EVENTADCVSYSRDY			Writing 1 disables interrupts from EVENTADCVSYSRDY								
		W1C	LOW	0	low								
			HIGH	1	high								
E	RW	EVENTADCSET1RDY			Writing 1 disables interrupts from EVENTADCSET1RDY								
		W1C	LOW	0	low								
			HIGH	1	high								
F	RW	EVENTADCSET2RDY			Writing 1 disables interrupts from EVENTADCSET2RDY								
		W1C	LOW	0	low								
			HIGH	1	high								
G	RW	EVENTADCIBATRDY			Writing 1 disables interrupts from EVENTADCIBATRDY								
		W1C	LOW	0	low								
			HIGH	1	high								
H	RW	EVENTADCVBUS7V0RDY			Writing 1 disables interrupts from EVENTADCVBUS7V0RDY								
		W1C	LOW	0	low								
			HIGH	1	high								

7.7.1.6 EVENTSBCARGER0SET

Address offset: 0x6

Battery Charger Temperature Events Event Set

Bit number						7	6	5	4	3	2	1	0
ID						F	E	D	C	B	A		
Reset 0x00						0	0	0	0	0	0	0	0
ID	R/W	Field	Value ID	Value	Description								
A	RW	EVENTNTCCOLD			Event when Cold Battery detected from NTC measure. Writing 1 sets the event (for debugging).								
		W1S	LOW	0	low								
			HIGH	1	high								
B	RW	EVENTNTCCOOL			Event when Cool Battery detected from NTC measure. Writing 1 sets the event (for debugging).								
		W1S	LOW	0	low								
			HIGH	1	high								
C	RW	EVENTNTCWARM			Event when Warm Battery detected from NTC measure. Writing 1 sets the event (for debugging).								
		W1S	LOW	0	low								
			HIGH	1	high								
D	RW	EVENTNTCHOT			Event when Hot Battery detected from NTC measure. Writing 1 sets the event (for debugging).								
		W1S	LOW	0	low								
			HIGH	1	high								
E	RW	EVENTDIETEMPHIGH			Event when die high temperature detected from Die Temp measure. Writing 1 sets the event (for debugging).								
		W1S											

Bit number						7	6	5	4	3	2	1	0
ID						F	E	D	C	B	A		
Reset 0x00						0	0	0	0	0	0	0	0
ID	R/W	Field	Value ID	Value	Description								
			LOW	0	low								
			HIGH	1	high								
F	RW	EVENTDIETEMPRESUME			Event when die resume temperature detected from Die Temp measure.								
		W1S			Writing 1 sets the event (for debugging).								
			LOW	0	low								
			HIGH	1	high								

7.7.1.7 EVENTSBCARGER0CLR

Address offset: 0x7

Battery Charger Temperature Events Event Clear

Bit number						7	6	5	4	3	2	1	0
ID						F	E	D	C	B	A		
Reset 0x00						0	0	0	0	0	0	0	0
ID	R/W	Field	Value ID	Value	Description								
A	RW	EVENTNTCCOLD			Event when Cold Battery detected from NTC measure. Writing 1 clears the event (e.g. to acknowledge an interrupt).								
		W1C											
			LOW	0	low								
			HIGH	1	high								
B	RW	EVENTNTCCOOL			Event when Cool Battery detected from NTC measure. Writing 1 clears the event (e.g. to acknowledge an interrupt).								
		W1C											
			LOW	0	low								
			HIGH	1	high								
C	RW	EVENTNTCWARM			Event when Warm Battery detected from NTC measure. Writing 1 clears the event (e.g. to acknowledge an interrupt).								
		W1C											
			LOW	0	low								
			HIGH	1	high								
D	RW	EVENTNTCHOT			Event when Hot Battery detected from NTC measure. Writing 1 clears the event (e.g. to acknowledge an interrupt).								
		W1C											
			LOW	0	low								
			HIGH	1	high								
E	RW	EVENTDIETEMPHIGH			Event when die high temperature detected from Die Temp measure. Writing 1 clears the event (e.g. to acknowledge an interrupt).								
		W1C											
			LOW	0	low								
			HIGH	1	high								
F	RW	EVENTDIETEMPRESUME			Event when die resume temperature detected from Die Temp measure.								
		W1C			Writing 1 clears the event (e.g. to acknowledge an interrupt).								
			LOW	0	low								
			HIGH	1	high								

7.7.1.8 INTENEVENTSBCHARGER0SET

Address offset: 0x8

Battery Charger Temperature Events Interrupt Enable Set

Bit number						7	6	5	4	3	2	1	0
ID						F	E	D	C	B	A		
Reset 0x00						0	0	0	0	0	0	0	0
ID	R/W	Field	Value ID	Value	Description								
A	RW	EVENTNTCCOLD W1S			Writing 1 enables interrupts from EVENTNTCCOLD								
			LOW	0	low								
			HIGH	1	high								
B	RW	EVENTNTCCOOL W1S			Writing 1 enables interrupts from EVENTNTCCOOL								
			LOW	0	low								
			HIGH	1	high								
C	RW	EVENTNTCWARM W1S			Writing 1 enables interrupts from EVENTNTCWARM								
			LOW	0	low								
			HIGH	1	high								
D	RW	EVENTNTCHOT W1S			Writing 1 enables interrupts from EVENTNTCHOT								
			LOW	0	low								
			HIGH	1	high								
E	RW	EVENTDIETEMPHIGH W1S			Writing 1 enables interrupts from EVENTDIETEMPHIGH								
			LOW	0	low								
			HIGH	1	high								
F	RW	EVENTDIETEMPRESUME W1S			Writing 1 enables interrupts from EVENTDIETEMPRESUME								
			LOW	0	low								
			HIGH	1	high								

7.7.1.9 INTENEVENTSBCHARGER0CLR

Address offset: 0x9

Battery Charger Temperature Events Interrupt Enable Clear

Bit number						7	6	5	4	3	2	1	0
ID						F	E	D	C	B	A		
Reset 0x00						0	0	0	0	0	0	0	0
ID	R/W	Field	Value ID	Value	Description								
A	RW	EVENTNTCCOLD W1C			Writing 1 disables interrupts from EVENTNTCCOLD								
			LOW	0	low								
			HIGH	1	high								
B	RW	EVENTNTCCOOL W1C			Writing 1 disables interrupts from EVENTNTCCOOL								
			LOW	0	low								
			HIGH	1	high								
C	RW	EVENTNTCWARM W1C			Writing 1 disables interrupts from EVENTNTCWARM								
			LOW	0	low								
			HIGH	1	high								
D	RW	EVENTNTCHOT W1C			Writing 1 disables interrupts from EVENTNTCHOT								
			LOW	0	low								

Bit number						7	6	5	4	3	2	1	0
ID						F	E	D	C	B	A		
Reset 0x00						0	0	0	0	0	0	0	0
ID	R/W	Field	Value ID	Value	Description								
E	RW	EVENTDIETEMPHIGH W1C	HIGH	1	high								
			LOW	0	low								
			HIGH	1	high								
F	RW	EVENTDIETEMPRESUME W1C	HIGH	1	high								
			LOW	0	low								
			HIGH	1	high								

7.7.1.10 EVENTSCHARGER1SET

Address offset: 0xA

Battery Charger Status Events Event Set

Bit number						7	6	5	4	3	2	1	0
ID						F	E	D	C	B	A		
Reset 0x00						0	0	0	0	0	0	0	0
ID	R/W	Field	Value ID	Value	Description								
A	RW	EVENTSUPPLEMENT W1S	HIGH	1	high								
			LOW	0	low								
			HIGH	1	high								
B	RW	EVENTCHGTRICKLE W1S	HIGH	1	high								
			LOW	0	low								
			HIGH	1	high								
C	RW	EVENTCHGCC W1S	HIGH	1	high								
			LOW	0	low								
			HIGH	1	high								
D	RW	EVENTCHGCV W1S	HIGH	1	high								
			LOW	0	low								
			HIGH	1	high								
E	RW	EVENTCHGCOMPLETED W1S	HIGH	1	high								
			LOW	0	low								
			HIGH	1	high								
F	RW	EVENTCHGERROR W1S	HIGH	1	high								
			LOW	0	low								
			HIGH	1	high								

7.7.1.11 EVENTSCHARGER1CLR

Address offset: 0xB

Battery Charger Status Events Event Clear

Bit number						7	6	5	4	3	2	1	0
ID						F	E	D	C	B	A		
Reset 0x00						0	0	0	0	0	0	0	0
ID	R/W	Field	Value ID	Value	Description								
A	RW	EVENTSUPPLEMENT W1C			Event supplement mode activated. Writing 1 clears the event (e.g. to acknowledge an interrupt).								
			LOW	0	low								
			HIGH	1	high								
B	RW	EVENTCHGTRICKLE W1C			Event Trickle Charge started. Writing 1 clears the event (e.g. to acknowledge an interrupt).								
			LOW	0	low								
			HIGH	1	high								
C	RW	EVENTCHGCC W1C			Event Constant Current charging started. Writing 1 clears the event (e.g. to acknowledge an interrupt).								
			LOW	0	low								
			HIGH	1	high								
D	RW	EVENTCHGCV W1C			Event Constant Voltage charging started. Writing 1 clears the event (e.g. to acknowledge an interrupt).								
			LOW	0	low								
			HIGH	1	high								
E	RW	EVENTCHGCOMPLETED W1C			Event charging completed (Battery Full). Writing 1 clears the event (e.g. to acknowledge an interrupt).								
			LOW	0	low								
			HIGH	1	high								
F	RW	EVENTCHGERROR W1C			Event charging error. Writing 1 clears the event (e.g. to acknowledge an interrupt).								
			LOW	0	low								
			HIGH	1	high								

7.7.1.12 INTENEVENTSBCHARGER1SET

Address offset: 0xC

Battery Charger Status Events Interrupt Enable Set

Bit number						7	6	5	4	3	2	1	0
ID						F	E	D	C	B	A		
Reset 0x00						0	0	0	0	0	0	0	0
ID	R/W	Field	Value ID	Value	Description								
A	RW	EVENTSUPPLEMENT W1S			Writing 1 enables interrupts from EVENTSUPPLEMENT								
			LOW	0	low								
			HIGH	1	high								
B	RW	EVENTCHGTRICKLE W1S			Writing 1 enables interrupts from EVENTCHGTRICKLE								
			LOW	0	low								
			HIGH	1	high								
C	RW	EVENTCHGCC W1S			Writing 1 enables interrupts from EVENTCHGCC								
			LOW	0	low								
			HIGH	1	high								
D	RW	EVENTCHGCV W1S			Writing 1 enables interrupts from EVENTCHGCV								
			LOW	0	low								

Bit number						7	6	5	4	3	2	1	0
ID						F	E	D	C	B	A		
Reset 0x00						0	0	0	0	0	0	0	0
ID	R/W	Field	Value ID	Value	Description								
			HIGH	1	high								
E	RW	EVENTCHGCOMPLETED			Writing 1 enables interrupts from EVENTCHGCOMPLETED								
		W1S											
			LOW	0	low								
			HIGH	1	high								
F	RW	EVENTCHGERROR			Writing 1 enables interrupts from EVENTCHGERROR								
		W1S											
			LOW	0	low								
			HIGH	1	high								

7.7.1.13 INTENEVENTSBCHARGER1CLR

Address offset: 0xD

Battery Charger Status Events Interrupt Enable Clear

Bit number						7	6	5	4	3	2	1	0
ID						F	E	D	C	B	A		
Reset 0x00						0	0	0	0	0	0	0	0
ID	R/W	Field	Value ID	Value	Description								
A	RW	EVENTSUPPLEMENT			Writing 1 disables interrupts from EVENTSUPPLEMENT								
		W1C											
			LOW	0	low								
			HIGH	1	high								
B	RW	EVENTCHGTRICKLE			Writing 1 disables interrupts from EVENTCHGTRICKLE								
		W1C											
			LOW	0	low								
			HIGH	1	high								
C	RW	EVENTCHGCC			Writing 1 disables interrupts from EVENTCHGCC								
		W1C											
			LOW	0	low								
			HIGH	1	high								
D	RW	EVENTCHGCV			Writing 1 disables interrupts from EVENTCHGCV								
		W1C											
			LOW	0	low								
			HIGH	1	high								
E	RW	EVENTCHGCOMPLETED			Writing 1 disables interrupts from EVENTCHGCOMPLETED								
		W1C											
			LOW	0	low								
			HIGH	1	high								
F	RW	EVENTCHGERROR			Writing 1 disables interrupts from EVENTCHGERROR								
		W1C											
			LOW	0	low								
			HIGH	1	high								

7.7.1.14 EVENTSCHARGER2SET

Address offset: 0xE

Battery Charger Battery Events Event Set

Bit number						7	6	5	4	3	2	1	0
ID									C			B	A
Reset 0x00						0	0	0	0	0	0	0	0
ID	R/W	Field	Value ID	Value	Description								
A	RW	EVENTBATDETECTED			Event Battery Detected. Writing 1 sets the event (for debugging).								
			W1S										
				LOW	0	low							
			HIGH	1	high								
B	RW	EVENTBATLOST			Event Battery Lost. Writing 1 sets the event (for debugging).								
			W1S										
				LOW	0	low							
			HIGH	1	high								
C	RW	EVENTBATRECHARGE			Event Battery re-charge needed. Writing 1 sets the event (for debugging).								
			W1S										
				LOW	0	low							
			HIGH	1	high								

7.7.1.15 EVENTSBCARGER2CLR

Address offset: 0xF

Battery Charger Battery Events Event Clear

Bit number						7	6	5	4	3	2	1	0
ID									C			B	A
Reset 0x00						0	0	0	0	0	0	0	0
ID	R/W	Field	Value ID	Value	Description								
A	RW	EVENTBATDETECTED			Event Battery Detected. Writing 1 clears the event (e.g. to acknowledge an interrupt).								
			W1C										
				LOW	0	low							
			HIGH	1	high								
B	RW	EVENTBATLOST			Event Battery Lost. Writing 1 clears the event (e.g. to acknowledge an interrupt).								
			W1C										
				LOW	0	low							
			HIGH	1	high								
C	RW	EVENTBATRECHARGE			Event Battery re-charge needed. Writing 1 clears the event (e.g. to acknowledge an interrupt).								
			W1C										
				LOW	0	low							
			HIGH	1	high								

7.7.1.16 INTENEVENTSBCHARGER2SET

Address offset: 0x10

Battery Charger Battery Events Interrupt Enable Set

Bit number						7	6	5	4	3	2	1	0
ID									C			B	A
Reset 0x00						0	0	0	0	0	0	0	0
ID	R/W	Field	Value ID	Value	Description								
A	RW	EVENTBATDETECTED			Writing 1 enables interrupts from EVENTBATDETECTED								
			W1S										
				LOW	0	low							
			HIGH	1	high								
B	RW	EVENTBATLOST			Writing 1 enables interrupts from EVENTBATLOST								
			W1S										
				LOW	0	low							
			HIGH	1	high								
C	RW	EVENTBATRECHARGE			Writing 1 enables interrupts from EVENTBATRECHARGE								
			W1S										
				LOW	0	low							
			HIGH	1	high								

7.7.1.17 INTENEVENTSBCHARGER2CLR

Address offset: 0x11

Battery Charger Battery Events Interrupt Enable Clear

Bit number						7	6	5	4	3	2	1	0
ID									C			B	A
Reset 0x00						0	0	0	0	0	0	0	0
ID	R/W	Field	Value ID	Value	Description								
A	RW	EVENTBATDETECTED			Writing 1 disables interrupts from EVENTBATDETECTED								
			W1C										
				LOW	0	low							
			HIGH	1	high								
B	RW	EVENTBATLOST			Writing 1 disables interrupts from EVENTBATLOST								
			W1C										
				LOW	0	low							
			HIGH	1	high								
C	RW	EVENTBATRECHARGE			Writing 1 disables interrupts from EVENTBATRECHARGE								
			W1C										
				LOW	0	low							
			HIGH	1	high								

7.7.1.18 EVENTSSPHLDSET

Address offset: 0x12

ShipHold pin Events Event Set

Bit number						7	6	5	4	3	2	1	0	
ID									D			C	B	A
Reset 0x00						0	0	0	0	0	0	0	0	
ID	R/W	Field	Value ID	Value	Description									
A	RW	EVENTSHPHLDBTNPRESS			Event when Ship-Hold button is pressed. Writing 1 sets the event (for debugging).									
			W1S											
				LOW	0	low								
			HIGH	1	high									

Bit number						7	6	5	4	3	2	1	0
ID										D	C	B	A
Reset 0x00						0 0 0 0 0 0 0 0							
ID	R/W	Field	Value ID	Value	Description								
B	RW	EVENTSHPHLDBTNRELEASE W1S			Event when Ship-Hold button is Released. Writing 1 sets the event (for debugging).								
			LOW	0	low								
			HIGH	1	high								
C	RW	EVENTSHPHLDEXIT W1S			Event when Ship-Hold button held to Exit. Writing 1 sets the event (for debugging).								
			LOW	0	low								
			HIGH	1	high								
D	RW	EVENTWATCHDOGWARN W1S			Event when Watchdog Timeout Warning detected. Writing 1 sets the event (for debugging).								
			LOW	0	low								
			HIGH	1	high								

7.7.1.19 EVENTSSHPHLDCLR

Address offset: 0x13

ShipHold pin Events Event Clear

Bit number						7	6	5	4	3	2	1	0
ID										D	C	B	A
Reset 0x00						0 0 0 0 0 0 0 0							
ID	R/W	Field	Value ID	Value	Description								
A	RW	EVENTSHPHLDBTNPRESS W1C			Event when Ship-Hold button is pressed. Writing 1 clears the event (e.g. to acknowledge an interrupt).								
			LOW	0	low								
			HIGH	1	high								
B	RW	EVENTSHPHLDBTNRELEASE W1C			Event when Ship-Hold button is Released. Writing 1 clears the event (e.g. to acknowledge an interrupt).								
			LOW	0	low								
			HIGH	1	high								
C	RW	EVENTSHPHLDEXIT W1C			Event when Ship-Hold button held to Exit. Writing 1 clears the event (e.g. to acknowledge an interrupt).								
			LOW	0	low								
			HIGH	1	high								
D	RW	EVENTWATCHDOGWARN W1C			Event when Watchdog Timeout Warning detected. Writing 1 clears the event (e.g. to acknowledge an interrupt).								
			LOW	0	low								
			HIGH	1	high								

7.7.1.20 INTENEVENTSSHPHLSET

Address offset: 0x14

ShipHold pin Events Interrupt Enable Set

Bit number						7	6	5	4	3	2	1	0
ID										D	C	B	A
Reset 0x00						0	0	0	0	0	0	0	0
ID	R/W	Field	Value ID	Value	Description								
A	RW	EVENTSHPHLDBTNPRESS W1S			Writing 1 enables interrupts from EVENTSHPHLDBTNPRESS								
			LOW	0	low								
			HIGH	1	high								
B	RW	EVENTSHPHLDBTNRELEASE W1S			Writing 1 enables interrupts from EVENTSHPHLDBTNRELEASE								
			LOW	0	low								
			HIGH	1	high								
C	RW	EVENTSHPHLDEXIT W1S			Writing 1 enables interrupts from EVENTSHPHLDEXIT								
			LOW	0	low								
			HIGH	1	high								
D	RW	EVENTWATCHDOGWARN W1S			Writing 1 enables interrupts from EVENTWATCHDOGWARN								
			LOW	0	low								
			HIGH	1	high								

7.7.1.21 INTENEVENTSSHPLDCLR

Address offset: 0x15

ShipHold pin Events Interrupt Enable Clear

Bit number						7	6	5	4	3	2	1	0
ID										D	C	B	A
Reset 0x00						0	0	0	0	0	0	0	0
ID	R/W	Field	Value ID	Value	Description								
A	RW	EVENTSHPHLDBTNPRESS W1C			Writing 1 disables interrupts from EVENTSHPHLDBTNPRESS								
			LOW	0	low								
			HIGH	1	high								
B	RW	EVENTSHPHLDBTNRELEASE W1C			Writing 1 disables interrupts from EVENTSHPHLDBTNRELEASE								
			LOW	0	low								
			HIGH	1	high								
C	RW	EVENTSHPHLDEXIT W1C			Writing 1 disables interrupts from EVENTSHPHLDEXIT								
			LOW	0	low								
			HIGH	1	high								
D	RW	EVENTWATCHDOGWARN W1C			Writing 1 disables interrupts from EVENTWATCHDOGWARN								
			LOW	0	low								
			HIGH	1	high								

7.7.1.22 EVENTSVBUSIN0SET

Address offset: 0x16

VBUSIN Voltage Detection Events Event Set

Bit number						7	6	5	4	3	2	1	0
ID						F	E	D	C	B	A		
Reset 0x00						0	0	0	0	0	0	0	0
ID	R/W	Field	Value ID	Value	Description								
A	RW	EVENTVBUSDETECTED			Event VBUS input detected. Writing 1 sets the event (for debugging).								
			W1S										
				LOW	0	low							
			HIGH	1	high								
B	RW	EVENTVBUSREMOVED			Event VBUS input removed. Writing 1 sets the event (for debugging).								
			W1S										
				LOW	0	low							
			HIGH	1	high								
C	RW	EVENTVBUSOVRVOLTDETECTED			Event VBUS Over Voltage Detected. Writing 1 sets the event (for debugging).								
			W1S										
				LOW	0	low							
			HIGH	1	high								
D	RW	EVENTVBUSOVRVOLTREMOVED			Event VBUS Over Removed. Writing 1 sets the event (for debugging).								
			W1S										
				LOW	0	low							
			HIGH	1	high								
E	RW	EVENTVBUSUNDVOLTDETECTED			Event VBUS Under Voltage Detected. Writing 1 sets the event (for debugging).								
			W1S										
				LOW	0	low							
			HIGH	1	high								
F	RW	EVENTVBUSUNDVOLTREMOVED			Event VBUS Under Removed. Writing 1 sets the event (for debugging).								
			W1S										
				LOW	0	low							
			HIGH	1	high								

7.7.1.23 EVENTSVBUSIN0CLR

Address offset: 0x17

VBUSIN Voltage Detection Events Event Clear

Bit number						7	6	5	4	3	2	1	0
ID						F	E	D	C	B	A		
Reset 0x00						0	0	0	0	0	0	0	0
ID	R/W	Field	Value ID	Value	Description								
A	RW	EVENTVBUSDETECTED			Event VBUS input detected. Writing 1 clears the event (e.g. to acknowledge an interrupt).								
			W1C										
				LOW	0	low							
			HIGH	1	high								
B	RW	EVENTVBUSREMOVED			Event VBUS input removed. Writing 1 clears the event (e.g. to acknowledge an interrupt).								
			W1C										
				LOW	0	low							
			HIGH	1	high								
C	RW	EVENTVBUSOVRVOLTDETECTED			Event VBUS Over Voltage Detected. Writing 1 clears the event (e.g. to acknowledge an interrupt).								
			W1C										
				LOW	0	low							
			HIGH	1	high								
D	RW	EVENTVBUSOVRVOLTREMOVED			Event VBUS Over Removed. Writing 1 clears the event (e.g. to acknowledge an interrupt).								
			W1C										
				LOW	0	low							

Bit number						7	6	5	4	3	2	1	0
ID						F	E	D	C	B	A		
Reset 0x00						0	0	0	0	0	0	0	0
ID	R/W	Field	Value ID	Value	Description								
			HIGH	1	high								
E	RW	EVENTVBUSUNDVOLTDETECTED			Event VBUS Under Voltage Detected. Writing 1 clears the event (e.g. to acknowledge an interrupt).								
	W1C		LOW	0	low								
			HIGH	1	high								
F	RW	EVENTVBUSUNDVOLTREMOVED			Event VBUS Under Removed. Writing 1 clears the event (e.g. to acknowledge an interrupt).								
	W1C		LOW	0	low								
			HIGH	1	high								

7.7.1.24 INTENEVENTSVBUSIN0SET

Address offset: 0x18

VBUSIN Voltage Detection Events Interrupt Enable Set

Bit number						7	6	5	4	3	2	1	0
ID						F	E	D	C	B	A		
Reset 0x00						0	0	0	0	0	0	0	0
ID	R/W	Field	Value ID	Value	Description								
A	RW	EVENTVBUSDETECTED			Writing 1 enables interrupts from EVENTVBUSDETECTED								
	W1S		LOW	0	low								
			HIGH	1	high								
B	RW	EVENTVBUSREMOVED			Writing 1 enables interrupts from EVENTVBUSREMOVED								
	W1S		LOW	0	low								
			HIGH	1	high								
C	RW	EVENTVBUSOVRVOLTDETECTED			Writing 1 enables interrupts from EVENTVBUSOVRVOLTDETECTED								
	W1S		LOW	0	low								
			HIGH	1	high								
D	RW	EVENTVBUSOVRVOLTREMOVED			Writing 1 enables interrupts from EVENTVBUSOVRVOLTREMOVED								
	W1S		LOW	0	low								
			HIGH	1	high								
E	RW	EVENTVBUSUNDVOLTDETECTED			Writing 1 enables interrupts from EVENTVBUSUNDVOLTDETECTED								
	W1S		LOW	0	low								
			HIGH	1	high								
F	RW	EVENTVBUSUNDVOLTREMOVED			Writing 1 enables interrupts from EVENTVBUSUNDVOLTREMOVED								
	W1S		LOW	0	low								
			HIGH	1	high								

7.7.1.25 INTENEVENTSVBUSIN0CLR

Address offset: 0x19

VBUSIN Voltage Detection Events Interrupt Enable Clear

Bit number						7	6	5	4	3	2	1	0
ID						F	E	D	C	B	A		
Reset 0x00						0	0	0	0	0	0	0	0
ID	R/W	Field	Value ID	Value	Description								
A	RW	EVENTVBUSDETECTED W1C			Writing 1 disables interrupts from EVENTVBUSDETECTED								
			LOW	0	low								
			HIGH	1	high								
B	RW	EVENTVBUSREMOVED W1C			Writing 1 disables interrupts from EVENTVBUSREMOVED								
			LOW	0	low								
			HIGH	1	high								
C	RW	EVENTBUSOVRVOLTDETECTED W1C			Writing 1 disables interrupts from EVENTBUSOVRVOLTDETECTED								
			LOW	0	low								
			HIGH	1	high								
D	RW	EVENTBUSOVRVOLTREMOVED W1C			Writing 1 disables interrupts from EVENTBUSOVRVOLTREMOVED								
			LOW	0	low								
			HIGH	1	high								
E	RW	EVENTBUSUNDVOLTDETECTED W1C			Writing 1 disables interrupts from EVENTBUSUNDVOLTDETECTED								
			LOW	0	low								
			HIGH	1	high								
F	RW	EVENTBUSUNDVOLTREMOVED W1C			Writing 1 disables interrupts from EVENTBUSUNDVOLTREMOVED								
			LOW	0	low								
			HIGH	1	high								

7.7.1.26 EVENTSVBUSIN1SET

Address offset: 0x1A

VBUSIN Thermal and USB Events Event Set

Bit number						7	6	5	4	3	2	1	0
ID						F	E	D	C	B	A		
Reset 0x00						0	0	0	0	0	0	0	0
ID	R/W	Field	Value ID	Value	Description								
A	RW	EVENTTHERMALWARNDTECTED W1S			Event Thermal Warning detected. Writing 1 sets the event (for debugging).								
			LOW	0	low								
			HIGH	1	high								
B	RW	EVENTTHERMALWARNREMOVED W1S			Event Thermal Warning removed. Writing 1 sets the event (for debugging).								
			LOW	0	low								
			HIGH	1	high								
C	RW	EVENTTHERMALSHUTDOWNDETECTED W1S			Event Thermal Shutdown detected. Writing 1 sets the event (for debugging).								
			LOW	0	low								
			HIGH	1	high								
D	RW	EVENTTHERMALSHUTDOWNREMOVED W1S			Event Thermal Shutdown removed. Writing 1 sets the event (for debugging).								
			LOW	0	low								

Bit number						7	6	5	4	3	2	1	0
ID						F	E	D	C	B	A		
Reset 0x00						0	0	0	0	0	0	0	0
ID	R/W	Field	Value ID	Value	Description								
			HIGH	1	high								
E	RW	EVENTCC1STATECHANGE			Event when Voltage on CC1 changes. Writing 1 sets the event (for debugging).								
			LOW	0	low								
			HIGH	1	high								
F	RW	EVENTCC2STATECHANGE			Event when Voltage on CC2 changes. Writing 1 sets the event (for debugging).								
			LOW	0	low								
			HIGH	1	high								

7.7.1.27 EVENTSVBUSIN1CLR

Address offset: 0x1B

VBUSIN Thermal and USB Events Event Clear

Bit number						7	6	5	4	3	2	1	0
ID						F	E	D	C	B	A		
Reset 0x00						0	0	0	0	0	0	0	0
ID	R/W	Field	Value ID	Value	Description								
A	RW	EVENTTHERMALWARNDETECTED			Event Thermal Warning detected. Writing 1 clears the event (e.g. to acknowledge an interrupt).								
			LOW	0	low								
			HIGH	1	high								
B	RW	EVENTTHERMALWARNREMOVED			Event Thermal Warning removed. Writing 1 clears the event (e.g. to acknowledge an interrupt).								
			LOW	0	low								
			HIGH	1	high								
C	RW	EVENTTHERMALSHUTDOWNDETECTED			Event Thermal Shutdown detected. Writing 1 clears the event (e.g. to acknowledge an interrupt).								
			LOW	0	low								
			HIGH	1	high								
D	RW	EVENTTHERMALSHUTDOWNREMOVED			Event Thermal Shutdown removed. Writing 1 clears the event (e.g. to acknowledge an interrupt).								
			LOW	0	low								
			HIGH	1	high								
E	RW	EVENTCC1STATECHANGE			Event when Voltage on CC1 changes. Writing 1 clears the event (e.g. to acknowledge an interrupt).								
			LOW	0	low								
			HIGH	1	high								
F	RW	EVENTCC2STATECHANGE			Event when Voltage on CC2 changes. Writing 1 clears the event (e.g. to acknowledge an interrupt).								
			LOW	0	low								
			HIGH	1	high								

7.7.1.28 INTENEVENTSVBUSIN1SET

Address offset: 0x1C

VBUSIN Thermal and USB Events Interrupt Enable Set

Bit number						7	6	5	4	3	2	1	0
ID						F	E	D	C	B	A		
Reset 0x00						0	0	0	0	0	0	0	0
ID	R/W	Field	Value ID	Value	Description								
A	RW	EVENTTHERMALWARNDETECTED W1S			Writing 1 enables interrupts from EVENTTHERMALWARNDETECTED								
			LOW	0	low								
			HIGH	1	high								
B	RW	EVENTTHERMALWARNREMOVED W1S			Writing 1 enables interrupts from EVENTTHERMALWARNREMOVED								
			LOW	0	low								
			HIGH	1	high								
C	RW	EVENTTHERMALSHUTDOWNDETECTED W1S			Writing 1 enables interrupts from EVENTTHERMALSHUTDOWNDETECTED								
			LOW	0	low								
			HIGH	1	high								
D	RW	EVENTTHERMALSHUTDOWNREMOVED W1S			Writing 1 enables interrupts from EVENTTHERMALSHUTDOWNREMOVED								
			LOW	0	low								
			HIGH	1	high								
E	RW	EVENTCC1STATECHANGE W1S			Writing 1 enables interrupts from EVENTCC1STATECHANGE								
			LOW	0	low								
			HIGH	1	high								
F	RW	EVENTCC2STATECHANGE W1S			Writing 1 enables interrupts from EVENTCC2STATECHANGE								
			LOW	0	low								
			HIGH	1	high								

7.7.1.29 INTENEVENTSVBUSIN1CLR

Address offset: 0x1D

VBUSIN Thermal and USB Events Interrupt Enable Clear

Bit number						7	6	5	4	3	2	1	0
ID						F	E	D	C	B	A		
Reset 0x00						0	0	0	0	0	0	0	0
ID	R/W	Field	Value ID	Value	Description								
A	RW	EVENTTHERMALWARNDETECTED W1C			Writing 1 disables interrupts from EVENTTHERMALWARNDETECTED								
			LOW	0	low								
			HIGH	1	high								
B	RW	EVENTTHERMALWARNREMOVED W1C			Writing 1 disables interrupts from EVENTTHERMALWARNREMOVED								
			LOW	0	low								
			HIGH	1	high								
C	RW	EVENTTHERMALSHUTDOWNDETECTED W1C			Writing 1 disables interrupts from EVENTTHERMALSHUTDOWNDETECTED								
			LOW	0	low								
			HIGH	1	high								
D	RW	EVENTTHERMALSHUTDOWNREMOVED W1C			Writing 1 disables interrupts from EVENTTHERMALSHUTDOWNREMOVED								
			LOW	0	low								

Bit number						7	6	5	4	3	2	1	0
ID						F E D C B A							
Reset 0x00						0	0	0	0	0	0	0	0
ID	R/W	Field	Value ID	Value	Description								
			HIGH	1	high								
E	RW	EVENTCC1STATECHANGE			Writing 1 disables interrupts from EVENTCC1STATECHANGE								
		W1C											
			LOW	0	low								
			HIGH	1	high								
F	RW	EVENTCC2STATECHANGE			Writing 1 disables interrupts from EVENTCC2STATECHANGE								
		W1C											
			LOW	0	low								
			HIGH	1	high								

7.7.1.30 EVENTSGPIOSET

Address offset: 0x22

GPIO Event Event Set

Bit number						7	6	5	4	3	2	1	0
ID						E D C B A							
Reset 0x00						0	0	0	0	0	0	0	0
ID	R/W	Field	Value ID	Value	Description								
A	RW	EVENTGPIOEDGEDETECT0			Event when GPIO input 0 edge is detected. GPIO.GPIO_MODE = 3 : Rising Edge GPIO.GPIO_MODE = 4 : Falling Edge. Writing 1 sets the event (for debugging).								
		W1S											
			LOW	0	low								
			HIGH	1	high								
B	RW	EVENTGPIOEDGEDETECT1			Event when GPIO input 1 edge is detected. GPIO.GPIO_MODE = 3 : Rising Edge GPIO.GPIO_MODE = 4 : Falling Edge. Writing 1 sets the event (for debugging).								
		W1S											
			LOW	0	low								
			HIGH	1	high								
C	RW	EVENTGPIOEDGEDETECT2			Event when GPIO input 2 edge is detected. GPIO.GPIO_MODE = 3 : Rising Edge GPIO.GPIO_MODE = 4 : Falling Edge. Writing 1 sets the event (for debugging).								
		W1S											
			LOW	0	low								
			HIGH	1	high								
D	RW	EVENTGPIOEDGEDETECT3			Event when GPIO input 3 edge is detected. GPIO.GPIO_MODE = 3 : Rising Edge GPIO.GPIO_MODE = 4 : Falling Edge. Writing 1 sets the event (for debugging).								
		W1S											
			LOW	0	low								
			HIGH	1	high								
E	RW	EVENTGPIOEDGEDETECT4			Event when GPIO input 4 edge is detected. GPIO.GPIO_MODE = 3 : Rising Edge GPIO.GPIO_MODE = 4 : Falling Edge. Writing 1 sets the event (for debugging).								
		W1S											
			LOW	0	low								
			HIGH	1	high								

7.7.1.31 EVENTSGPIOCLR

Address offset: 0x23

GPIO Event Event Clear

Bit number					7	6	5	4	3	2	1	0					
ID											E	D	C	B	A		
Reset 0x00											0	0	0	0	0	0	0
ID	R/W	Field	Value ID	Value	Description												
A	RW	EVENTGPIOEDGEDETECT0 W1C			Event when GPIO input 0 edge is detected. GPIO.GPIO_MODE = 3 : Rising Edge GPIO.GPIO_MODE = 4 : Falling Edge. Writing 1 clears the event (e.g. to acknowledge an interrupt).												
			LOW	0								low					
			HIGH	1								high					
B	RW	EVENTGPIOEDGEDETECT1 W1C			Event when GPIO input 1 edge is detected. GPIO.GPIO_MODE = 3 : Rising Edge GPIO.GPIO_MODE = 4 : Falling Edge. Writing 1 clears the event (e.g. to acknowledge an interrupt).												
			LOW	0								low					
			HIGH	1								high					
C	RW	EVENTGPIOEDGEDETECT2 W1C			Event when GPIO input 2 edge is detected. GPIO.GPIO_MODE = 3 : Rising Edge GPIO.GPIO_MODE = 4 : Falling Edge. Writing 1 clears the event (e.g. to acknowledge an interrupt).												
			LOW	0								low					
			HIGH	1								high					
D	RW	EVENTGPIOEDGEDETECT3 W1C			Event when GPIO input 3 edge is detected. GPIO.GPIO_MODE = 3 : Rising Edge GPIO.GPIO_MODE = 4 : Falling Edge. Writing 1 clears the event (e.g. to acknowledge an interrupt).												
			LOW	0								low					
			HIGH	1								high					
E	RW	EVENTGPIOEDGEDETECT4 W1C			Event when GPIO input 4 edge is detected. GPIO.GPIO_MODE = 3 : Rising Edge GPIO.GPIO_MODE = 4 : Falling Edge. Writing 1 clears the event (e.g. to acknowledge an interrupt).												
			LOW	0								low					
			HIGH	1								high					

7.7.1.32 INTENEVENTSGPIOSSET

Address offset: 0x24

GPIO Event Interrupt Enable Set

Bit number					7	6	5	4	3	2	1	0				
ID											E	D	C	B	A	
Reset 0x00											0	0	0	0	0	0
ID	R/W	Field	Value ID	Value	Description											
A	RW	EVENTGPIOEDGEDETECT0 W1S			Writing 1 enables interrupts from EVENTGPIOEDGEDETECT0											
			LOW	0								low				
			HIGH	1								high				
B	RW	EVENTGPIOEDGEDETECT1 W1S			Writing 1 enables interrupts from EVENTGPIOEDGEDETECT1											
			LOW	0								low				
			HIGH	1								high				
C	RW	EVENTGPIOEDGEDETECT2 W1S			Writing 1 enables interrupts from EVENTGPIOEDGEDETECT2											
			LOW	0								low				
			HIGH	1								high				
D	RW	EVENTGPIOEDGEDETECT3 W1S			Writing 1 enables interrupts from EVENTGPIOEDGEDETECT3											
			LOW	0								low				
			HIGH	1								high				

Bit number						7	6	5	4	3	2	1	0
ID						E D C B A							
Reset 0x00						0	0	0	0	0	0	0	0
ID	R/W	Field	Value ID	Value	Description								
			LOW	0	low								
			HIGH	1	high								
E	RW	EVENTGPIOEDGEDETECT4			Writing 1 enables interrupts from EVENTGPIOEDGEDETECT4								
		W1S											
			LOW	0	low								
			HIGH	1	high								

7.7.1.33 INTENVENTSGPIOCLR

Address offset: 0x25

GPIO Event Interrupt Enable Clear

Bit number						7	6	5	4	3	2	1	0
ID						E D C B A							
Reset 0x00						0	0	0	0	0	0	0	0
ID	R/W	Field	Value ID	Value	Description								
A	RW	EVENTGPIOEDGEDETECT0			Writing 1 disables interrupts from EVENTGPIOEDGEDETECT0								
		W1C											
			LOW	0	low								
			HIGH	1	high								
B	RW	EVENTGPIOEDGEDETECT1			Writing 1 disables interrupts from EVENTGPIOEDGEDETECT1								
		W1C											
			LOW	0	low								
			HIGH	1	high								
C	RW	EVENTGPIOEDGEDETECT2			Writing 1 disables interrupts from EVENTGPIOEDGEDETECT2								
		W1C											
			LOW	0	low								
			HIGH	1	high								
D	RW	EVENTGPIOEDGEDETECT3			Writing 1 disables interrupts from EVENTGPIOEDGEDETECT3								
		W1C											
			LOW	0	low								
			HIGH	1	high								
E	RW	EVENTGPIOEDGEDETECT4			Writing 1 disables interrupts from EVENTGPIOEDGEDETECT4								
		W1C											
			LOW	0	low								
			HIGH	1	high								

7.8 Reset and error registers

This section details the error and reset related registers.

Note: During the cooling period after a TSD and if VSYS drops below VSYSLOW, VSYSLOW could be set instead of THERMALSHUTDOWN in register [RSTCAUSE](#) on page 146.

7.8.1 Registers

Instances

Instance	Base address	Description
ERRLOG	0x0000E00	Error Log registers ERRLOG register map

Register overview

Register	Offset	Description
TASKCLRERRLOG	0x0	task to clear the Errlog registers
SCRATCH0	0x1	Scratch register 0
SCRATCH1	0x2	Scratch register 1
RSTCAUSE	0x3	Error log for internal reset causes. Cleared with TASK_CLR_ERRLOG
CHARGERERRREASON	0x4	Error log for slowDomain. Cleared with TASK_CLR_ERRLOG
CHARGERERRSENSOR	0x5	Bcharger Fsm sensor error. Cleared with TASK_CLR_ERRLOG

7.8.1.1 TASKCLRERRLOG

Address offset: 0x0

task to clear the Errlog registers

Bit number	7	6	5	4	3	2	1	0
ID								A
Reset 0x00	0	0	0	0	0	0	0	0
ID	R/W	Field	Value ID	Value	Description			
A	W	TASKCLRERRLOG			Clear Errlog			

7.8.1.2 SCRATCH0

Address offset: 0x1

Scratch register 0

Bit number	7	6	5	4	3	2	1	0
ID	B	B	B	B	B	B	B	A
Reset 0x00	0	0	0	0	0	0	0	0
ID	R/W	Field	Value ID	Value	Description			
A	RW	BOOTTIMEREN			Enable Boot Monitor Timer, only cleared by POR			
			NOBOOTMON	0	bootMonitor disable			
			BOOTMON	1	bootMonitor enable			
B	RW	SCRATCH0			scratch register, only cleared by POR			

7.8.1.3 SCRATCH1

Address offset: 0x2

Scratch register 1

Bit number	7	6	5	4	3	2	1	0
ID	A	A	A	A	A	A	A	A
Reset 0x00	0	0	0	0	0	0	0	0
ID	R/W	Field	Value ID	Value	Description			
A	RW	SCRATCH1			scratch register, only cleared by POR			

7.8.1.4 RSTCAUSE

Address offset: 0x3

Error log for internal reset causes. Cleared with TASK_CLR_ERRLOG

Bit number	7	6	5	4	3	2	1	0
ID	G	F	E	D	C	B	A	A
Reset 0x00	0	0	0	0	0	0	0	0
ID	R/W	Field	Value ID	Value	Description			
A	R	SHIPMODEEXIT			internal reset caused by shipmode exit			
			NORST	0	no shipmode reset			
			RST	1	reset activated by shipmode exit			
B	R	BOOTMONORTIMEOUT			internal reset caused by boot monitor timeout			
			NORST	0	no bootMonitor reset			
			RST	1	reset activated by bootMonitor			
C	R	WATCHDOGTIMEOUT			internal reset caused by watchdog timeout			
			NORST	0	no watchdog reset			
			RST	1	reset activated by watchdog			
D	R	LONGPRESSTIMEOUT			internal reset caused by shphld long press			
			NORST	0	no long press reset			
			RST	1	Reset activated by long press of SHPHLD or SHPHLD+GPIO			
E	R	THERMALSHUTDOWN			internal reset caused by TSD			
			NORST	0	no TSD reset			
			RST	1	reset activated by TSD			
F	R	VSYSLOW			internal reset caused by POF, VSYS low			
			NORST	0	no VSYS low reset			
			RST	1	reset activated by VSYS low			
G	R	SWRESET			internal reset caused by soft reset			
			NORST	0	no s/w reset			
			RST	1	reset activated by s/w reset			

7.8.1.5 CHARGERERRREASON

Address offset: 0x4

Error log for slowDomain. Cleared with TASK_CLR_ERRLOG

Bit number	7	6	5	4	3	2	1	0
ID	G	F	E	D	C	B	A	A
Reset 0x00	0	0	0	0	0	0	0	0
ID	R/W	Field	Value ID	Value	Description			
A	R	NTCSENSORERR			NTC thermistor sensor error			
B	R	VBATSENSORERR			VBAT Sensor Error			
C	R	VBATLOW			VBAT Low Error			
D	R	VTRICKLE			Vtrickle Error			
E	R	MEASTIMEOUT			Measurement Timeout Error			
F	R	CHARGETIMEOUT			Charge Timeout Error			
G	R	TRICKLETIMEOUT			Trickle Timeout Error			

7.8.1.6 CHARGERERRSENSOR

Address offset: 0x5

Bcharger Fsm sensor error. Cleared with TASK_CLR_ERRLOG

Bit number		7 6 5 4 3 2 1 0							
ID		H G F E D C B A							
Reset 0x00		0 0 0 0 0 0 0 0							
ID	R/W	Field	Value ID	Value	Description				
A	R	SENSORNTCCOLD			NTC thermistor Cold sensor value during error				
B	R	SENSORNTCCOOL			NTC thermistor Cool sensor value during error				
C	R	SENSORNTCWARM			NTC thermistor Warm sensor value during error				
D	R	SENSORNTCHOT			NTC thermistor Hot sensor value during error				
E	R	SENSORVTERM			Vterm sensor value during error				
F	R	SENSORRECHARGE			Recharge sensor value during error				
G	R	SENSORVTRICKLE			Vtrickle sensor value during error				
H	R	SENSORVBATLOW			VbatLow sensor value during error				

8.3 USB port negotiation

nRF5x can connect to a USB host.

Port negotiation is performed after nPM1300 port detection. The nRF5x device and nPM1300 are both connected to USB-C in the application example.

- The **D+** and **D-** pins are connected to nRF5x. The **CC1** and **CC2** pins are connected to nPM1300. The nRF5x SoC must wait until nPM1300 completes port detection using the USB configuration channel.
- The nRF5x device must set the correct current limit as described in [Charge current limit \(I_{CHG}\)](#) on page 28.
- **VBUS** is supplied to SYSREG on nPM1300 and **VBUSOUT** supplies the nRF5x **VBUS** input.

VBUSOUT is only for host sensing and should not be used as a source.

8.4 Charging and error states

Three LEDs can be used for charging indicators or general purpose by the application.

8.5 Termination voltage and current

The termination voltage, V_{TERM} , is configured through TWI up to 4.45 V.

Charge current is configured through TWI.

8.6 NTC thermistor configuration

The **NTC** pin connects to an external NTC thermistor. Place the NTC thermistor with thermal coupling on the battery pack.

8.7 Ship mode

Ship mode is enabled at production time through the TWI interface.

SHPHLD is connected to **SW2** and is in the circuit to exit Ship mode. If another circuit is present instead of a button, any signal that is able to pull the **SHPHLD** pin low for the required period can be connected to that net. See [Ship and Hibernate modes](#) on page 117 for more information.

9 Hardware and layout

9.1 Pin assignments

The pin assignment figures and tables describe the pinouts for the product variants of the chip.

9.1.1 QFN32 pin assignments

The pin assignment figure and table describe the assignments for this variant of the chip.

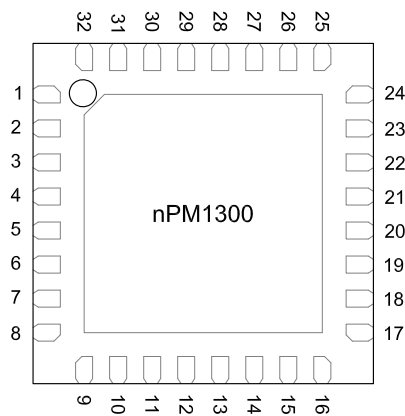

Figure 50: QFN32 pin assignments (top view)

Pin	Name	Function	Description
1	VOUT1	Power	BUCK1 output
2	PVSS1	Power	BUCK1 power ground
3	SW1	Power	BUCK1 regulator output to inductor
4	PVDD	Power	BUCK[n] power input
5	SW2	Power	BUCK2 regulator output to inductor
6	PVSS2	Power	BUCK2 power ground
7	GPIO0	Digital I/O	GPIO0
8	GPIO1	Digital I/O	GPIO1
9	GPIO2	Digital I/O	GPIO2
10	GPIO3	Digital I/O	GPIO3
11	GPIO4	Digital I/O	GPIO4
12	VDDIO	Power	Supply for TWI and GPIOs
13	SDA	Digital I/O	TWI data
14	SCL	Digital input	TWI clock
15	SHPHLD	Digital input	Ship mode hold
16	VSET2	Analog input	Voltage set for BUCK2 to resistor
17	VSET1	Analog input	Voltage set for BUCK1 to resistor
18	NTC	Analog input	Battery thermistor
19	VBAT	Power	Battery
20	VSYS	Power	System voltage output
21	VBUS	Power	Input supply
22	VBUSOUT	Analog output	VBUS output for host
23	CC1	Analog input	USB Type-C configuration channel 1
24	CC2	Analog input	USB Type-C configuration channel 2
25	LED0	Analog output	LEDDRV0 output
26	LED1	Analog output	LEDDRV1 output
27	LED2	Analog output	LEDDRV2 output
28	LSIN1/VINLDO1	Power	LOADSW1 supply or LDO1 input
29	LSOUT1/VOUTLDO1	Power	LOADSW1 or LDO1 output
30	LSIN2/VINLDO2	Power	LOADSW2 supply or LDO2 input
31	LSOUT2/VOUTLDO2	Power	LOADSW2 or LDO2 output
32	VOUT2	Power	BUCK2 output
Exposed pad	AVSS	Power	Ground

Table 35: QFN32 pin assignments

9.1.2 WLCSP ball assignments

The ball assignment figure and table describe the ball assignments for this variant of the chip.

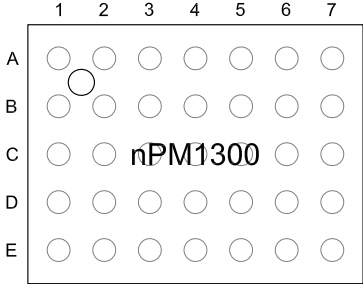

Figure 51: WLCSP ball assignment (top view)

Ball	Name	Function	Description
A1	LED0	Analog output	LEDDRV0 output
A2	LED1	Analog output	LEDDRV1 output
A3	LED2	Analog output	LEDDRV2 output
A4	LSOUT1/VOU TLDO1	Power	LOADSW1 or LDO1 output
A5	LSOUT2/VOU TLDO2	Power	LOADSW2 or LDO2 output
A6	AVSS	Power	Ground
A7	PVSS1	Power	BUCK1 power ground
B1, B2	VBUS	Power	Input supply
B3	CC2	Analog input	USB Type-C configuration channel 2
B4	LSIN1/VINLDO1	Power	LOADSW1 supply or LDO1 input
B5	LSIN2/VINLDO2	Power	LOADSW2 supply or LDO2 input
B6	VOUT1	Power	BUCK1 output
B7	SW1	Power	BUCK1 regulator output to inductor
C1, C2	VSYS	Power	System voltage output
C3	VBUSOUT	Analog output	VBUS output for host
C4	GPIO3	Digital I/O	GPIO3
C5	GPIO2	Digital I/O	GPIO2
C6	VOUT2	Power	BUCK2 output
C7	PVDD	Power	Power input for BUCK[n]
D1, D2	VBAT	Power	Battery
D3	NTC	Analog input	Battery thermistor
D4	SHPHLD	Digital input	Ship mode hold
D5	CC1	Analog input	USB Type-C configuration channel 1
D6	GPIO0	Digital I/O	GPIO0
D7	SW2	Power	BUCK2 regulator output to inductor
E1	VSET2	Analog input	Voltage set for BUCK2 to resistor
E2	VSET1	Analog input	Voltage set for BUCK1 to resistor
E3	SCL	Digital input	TWI clock
E4	VDDIO	Power	Supply for TWI and GPIOs
E5	SDA	Digital I/O	TWI data
E6	GPIO1	Digital I/O	GPIO1
E7	PVSS2	Power	BUCK2 power ground

Table 36: Pin descriptions

9.2 Mechanical specifications

The mechanical specifications for the packages show the dimensions in millimeters.

9.2.1 QFN32 5x5 mm package

Dimensions in millimeters for the QFN32 5.0x5.0 mm package.

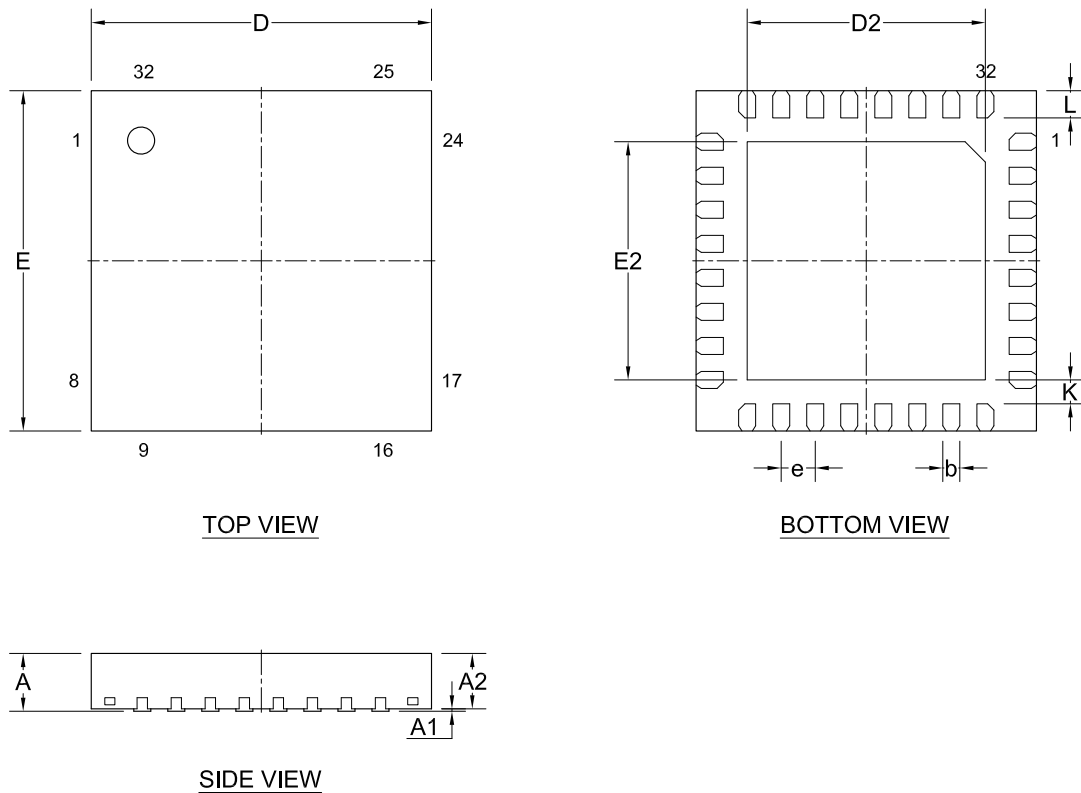

Figure 52: QFN32 5.0x5.0 mm package

	A	A1	A2	A3	b	D	D2	E	E2	e	K	L
Min.	0.8	0			0.2		3.4		3.4			0.3
Nom.	0.85	0.035	0.815		0.25	5	3.5	5	3.5	0.5	0.35	0.4
Max.	0.9	0.05			0.3		3.6		3.6			0.45

Table 37: QFN32 dimensions in millimeters

9.2.2 WLCSP package

Dimensions in millimeters for the WLCSP 2.3775x3.0775 mm package.

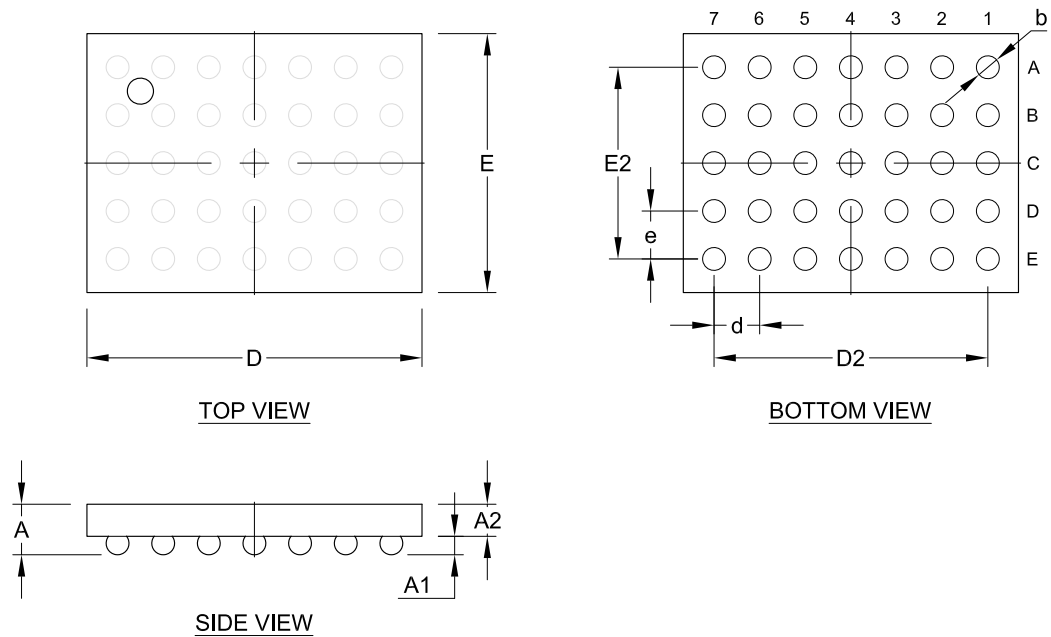

Figure 53: WLCSP 2.3775x3.0775 mm package

	A	A1	A2	A3	D	D2	d	E	E2	e	b	n
Min.	0.416	0.14	0.254	0.022							0.195	
Nom.	0.464		0.269	0.025	3.0775	2.514	0.419	2.3775	1.76	0.44		35
Max.	0.512	0.2	0.284	0.028							0.255	

Table 38: WLCSP dimensions in millimeters

9.3 Reference circuitry

Documentation for the different package reference circuits, including Altium Designer files, PCB layout files, and PCB production files, can be downloaded from www.nordicsemi.com.

The following reference circuits for nPM1300 show the schematics and components to support different configurations in a design.

	Configuration 1	Configuration 2	Configuration 3
Description	Full configuration	Simple configuration	Minimal configuration
BUCKs	Both configured	One configured	Not used
LOADSWs	Both configured, LDO mode	One configured, load switch mode	Not used
Ship mode exit	Configured	Configured	Not used
Charging	Available	Available	Available
Battery thermistor	Configured	Configured	Not used
LEDs	Three available	One available	Not used
GPIOs	Configured	Configured	Configured
TWI	Configured	Configured	Configured
VSET1	47 k Ω \pm 1%	47 k Ω \pm 1%	Not used
VSET2	150 k Ω \pm 1%	Not used	Not used
VOOUT1	1.8 V	1.8 V	Not used
VOOUT2	3.0 V	Not used	Not used
VBUSOUT	Configured	Configured	Not used
VDDIO	Configured	Configured	Configured

Table 39: PCB application configuration

9.3.1 Configuration 1

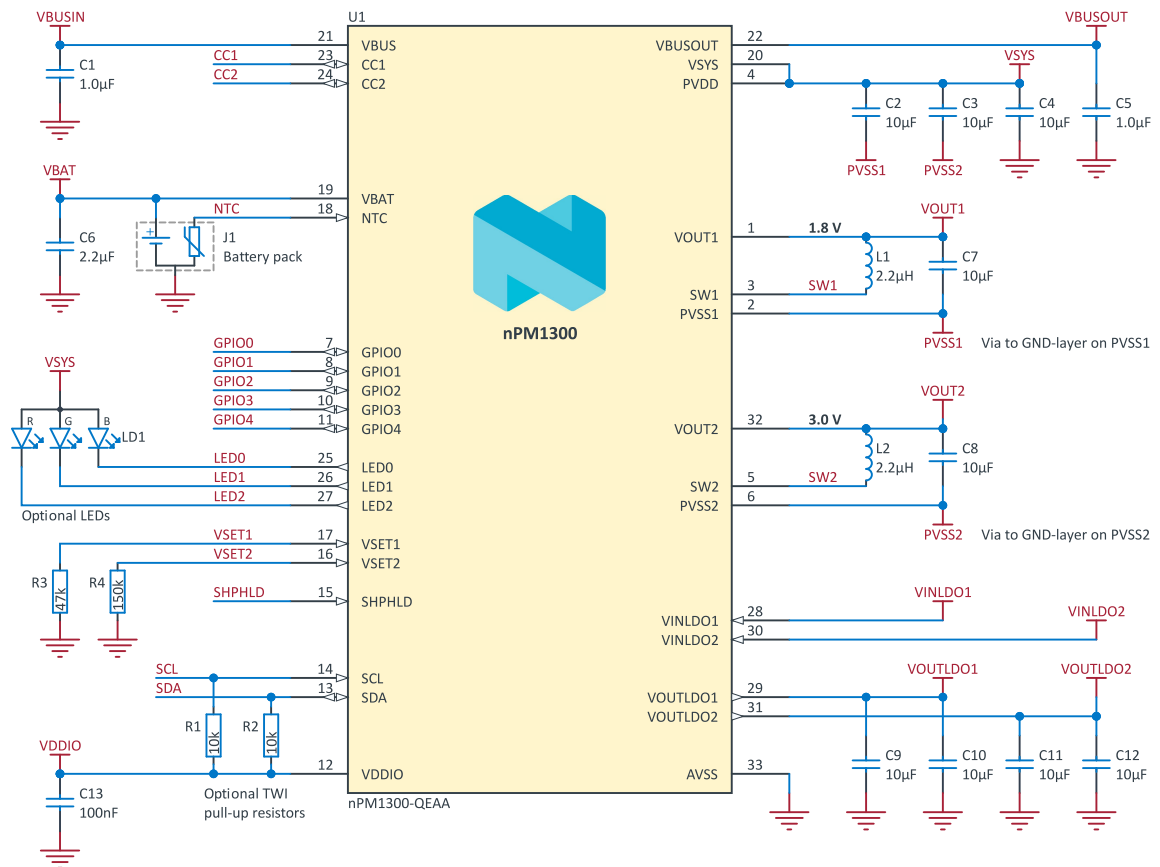

Figure 54: QFN schematic

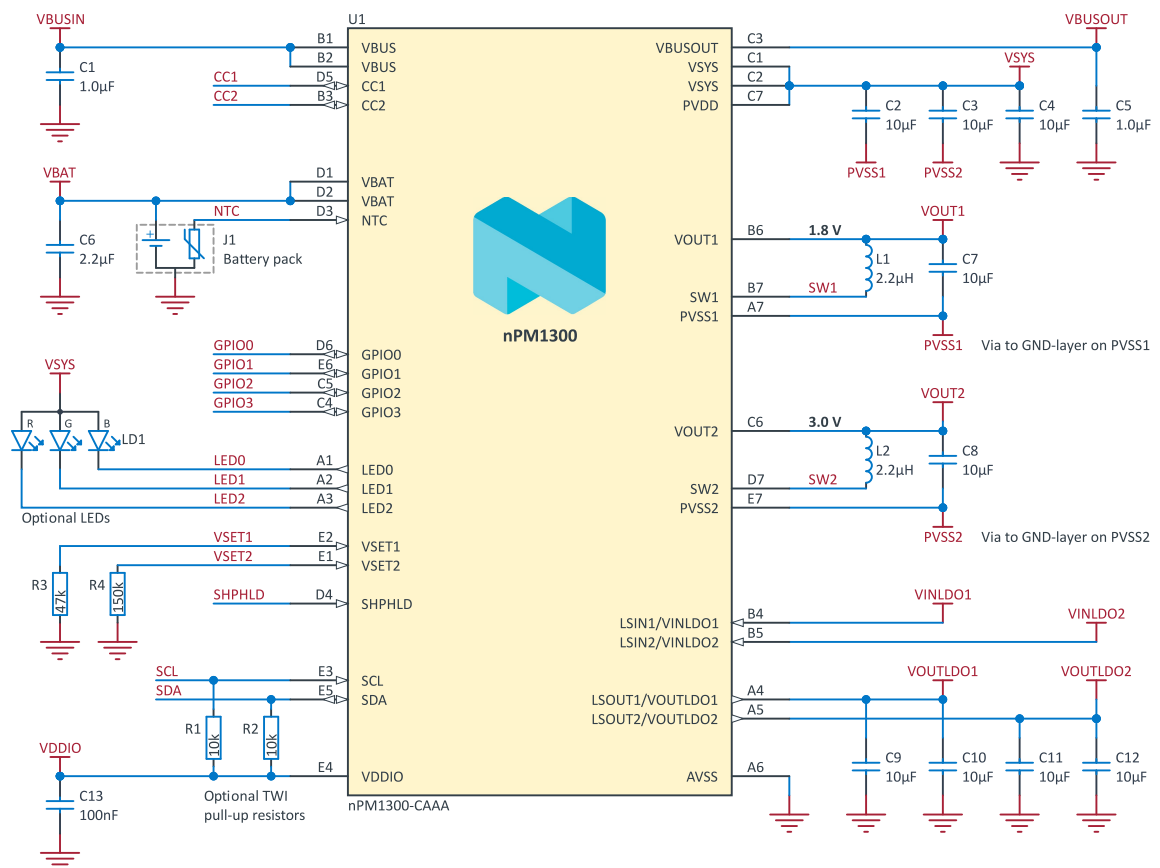

Figure 55: WLCSP schematic

Designator	Value	Description	Footprint
C1, C5	1.0 μ F	Capacitor, X5R, 10 V, \pm 10%	0603
C2, C3, C4, C7, C8, C9, C10, C11, C12	10 μ F	Capacitor, X5R, 25 V, \pm 20%	0603
C6	2.2 μ F	Capacitor, X7R, 16 V, \pm 10%	0603
C13	100 nF	Capacitor, X5R, \pm 10%	0201
L1, L2	2.2 μ H	Inductor, DCR < 400 m Ω , \pm 20%	0806
R1, R2	Dependent on bus speed and parasitic capacitances	Optional pull-up resistors for TWI, 0.05 W, \pm 1%	0201
R3, R4	See Output voltage selection on page 47	Resistors for setting the BUCK1 and BUCK2 output voltages, 0.05 W, \pm 1%	0201
U1	nPM1300	nPM1300	QFN32 or WLCSP35

Table 40: Bill of material

9.3.2 Configuration 2

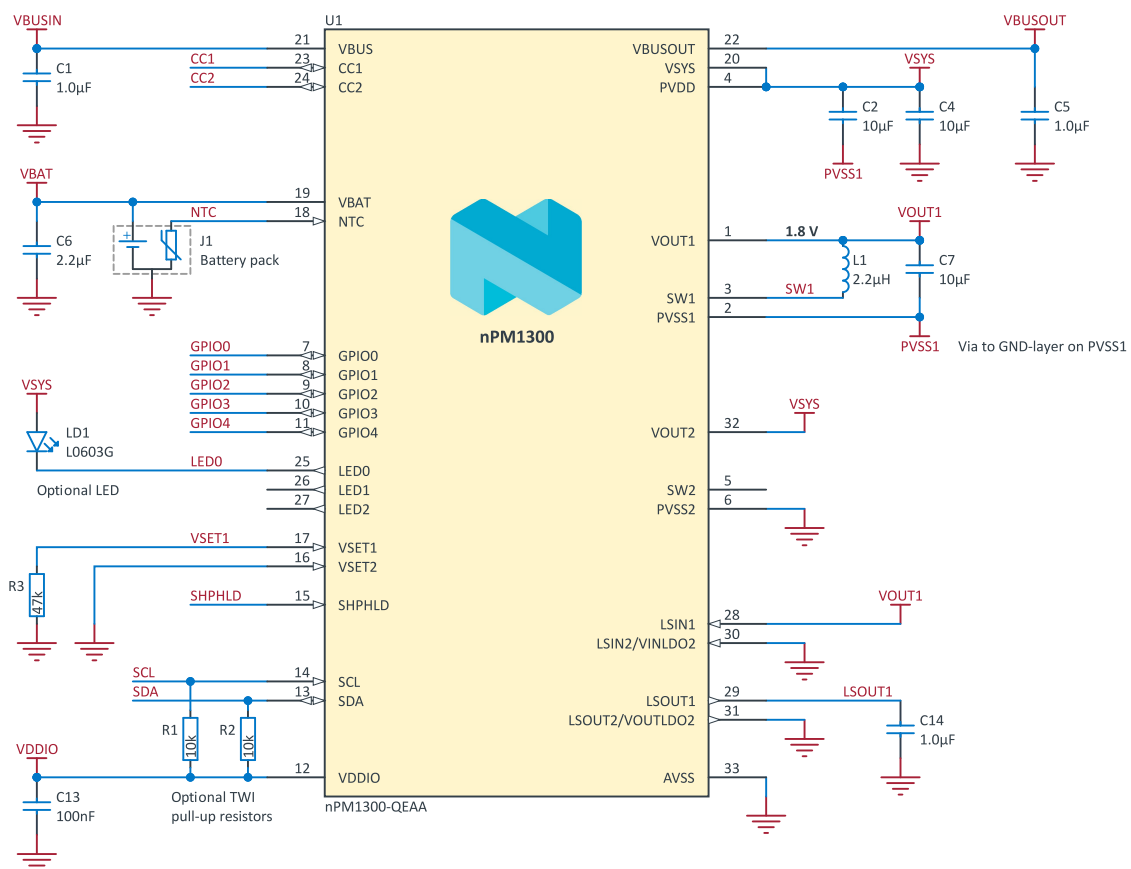

Figure 56: QFN schematic

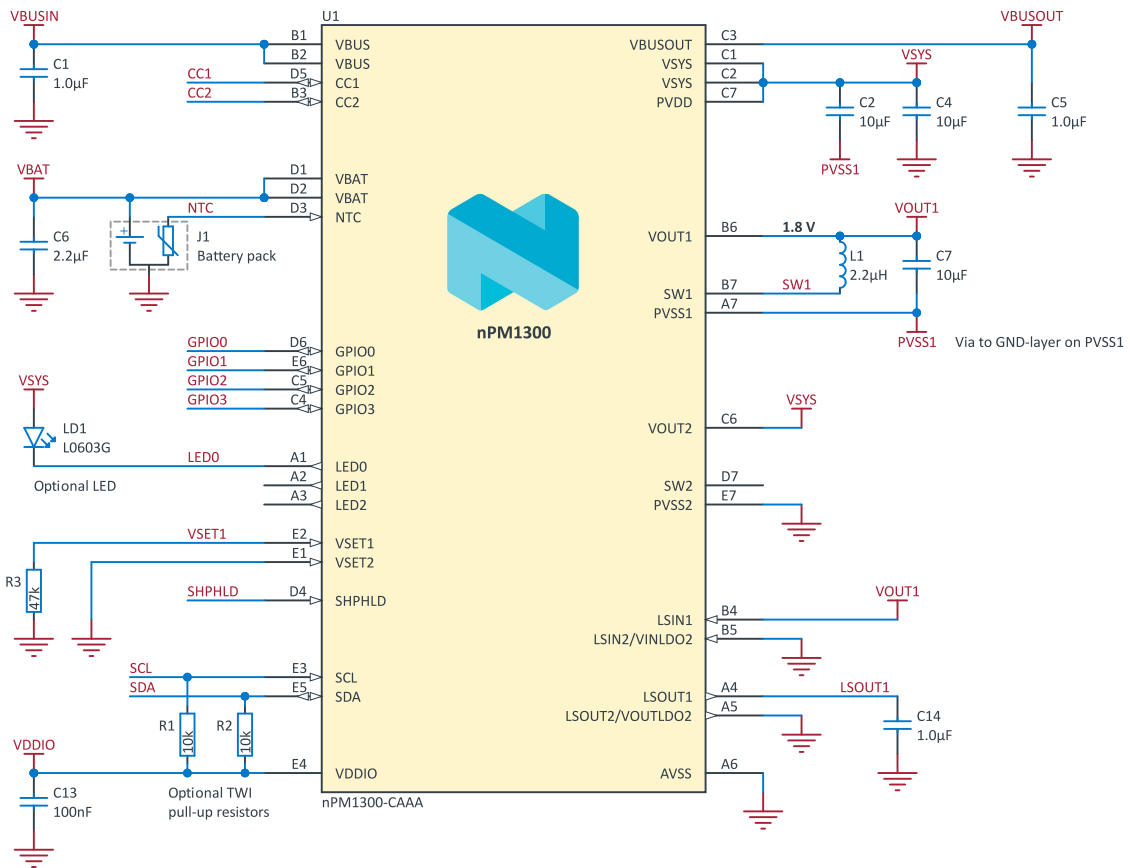

Figure 57: WLCSP schematic

Designator	Value	Description	Footprint
C1, C5, C14	1.0 μ F	Capacitor, X5R, 10 V, \pm 10%	0603
C2, C4, C7	10 μ F	Capacitor, X5R, 25 V, \pm 20%	0603
C6	2.2 μ F	Capacitor, X5R, 25 V, \pm 10%	0603
C13	100 nF	Capacitor, X5R, 25 V, \pm 10%	0201
L1	2.2 μ H	Inductor, DCR < 400 m Ω , \pm 20%	0806
R1, R2	Dependent on bus speed and parasitic capacitances	Optional pull-up resistors for TWI, 0.05 W, \pm 1%	0201
R3	See Output voltage selection on page 47	Resistors for setting the BUCK1 and BUCK2 output voltages, 0.05 W, \pm 1%	0201
U1	nPM1300	nPM1300	QFN32 or WLCSP35

Table 41: Bill of material

9.3.3 Configuration 3

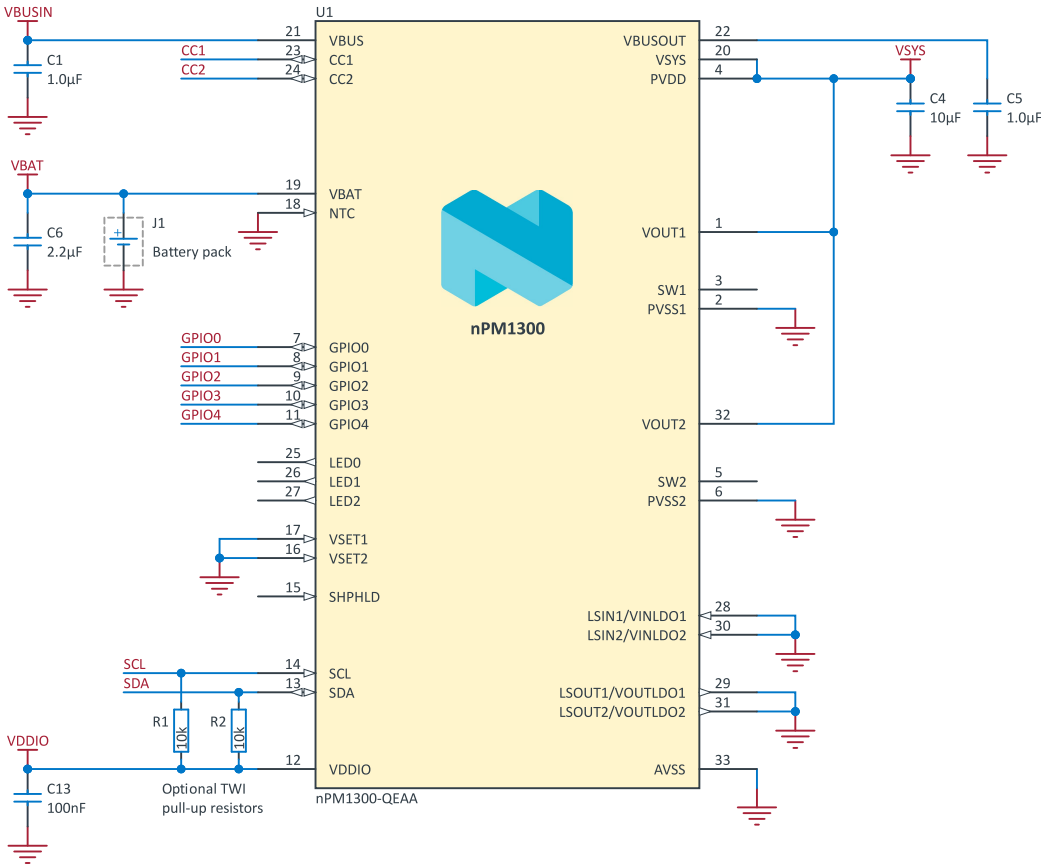

Figure 58: QFN schematic

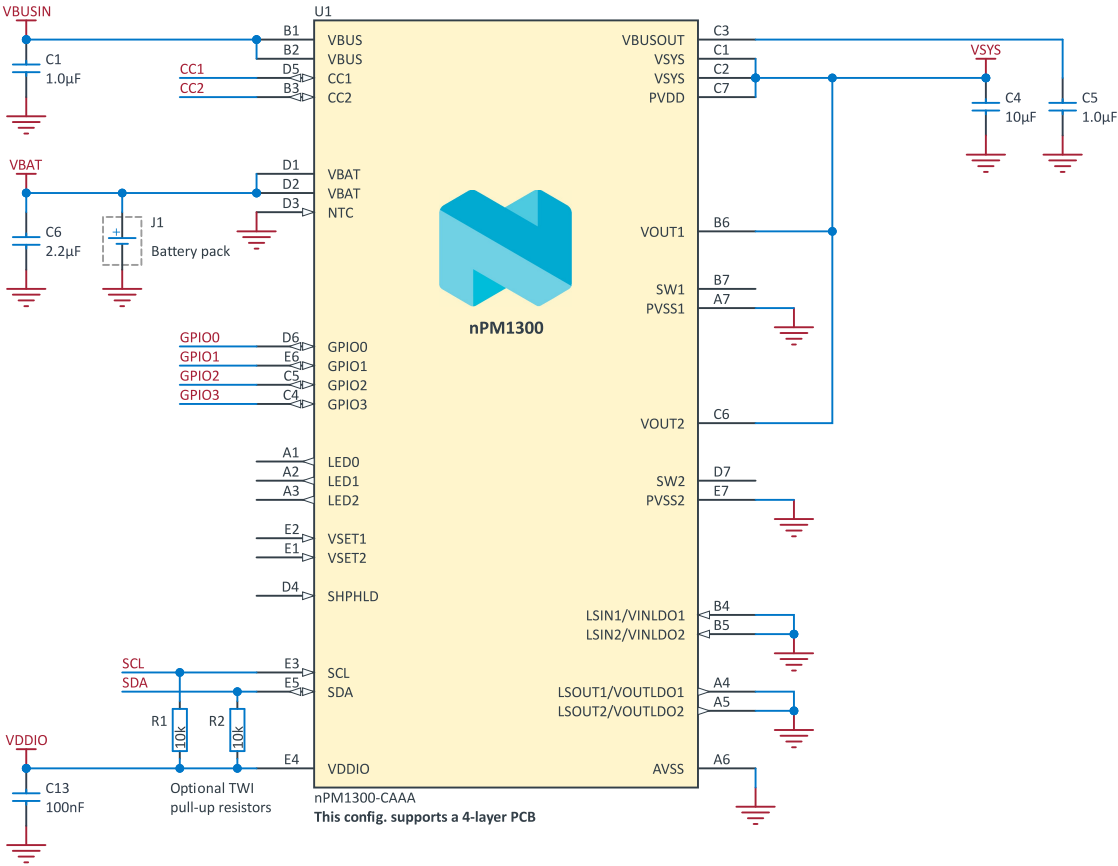

Figure 59: WLCSP schematic

Designator	Value	Description	Footprint
C1, C5	1.0 μ F	Capacitor, X5R, 10 V, \pm 10%	0603
C4	10 μ F	Capacitor, X5R, 25 V, \pm 20%	0603
C6	2.2 μ F	Capacitor, X7R, 16 V, \pm 10%	0603
C13	100 nF	Capacitor, X5R, \pm 10%	0201
R1, R2	Dependent on bus speed and parasitic capacitances	Optional pull-up resistors for TWI, 0.05 W, \pm 1%	0201
U1	nPM1300	nPM1300	QFN32 or WLCSP35

Table 42: Bill of material

9.3.4 PCB guidelines

A well designed PCB is necessary to achieve good performance. A poor layout can lead to loss in performance or functionality.

To ensure functionality, it is essential to follow the schematics and layout references closely.

A PCB with a minimum of two layers, including a ground plane, is recommended for optimal performance.

The BUCK supply voltage should be decoupled with high performance capacitors as close as possible to the supply pins.

Long power supply lines on the PCB should be avoided. All device grounds, VDD connections, and VDD bypass capacitors must be connected as close as possible to the device.

9.3.5 PCB layout example

The PCB layouts for configuration 1 are shown here for QFN followed by WLCSP.

QFN PCB layout

For all available reference layouts, see the Reference Layout section on the **Downloads** tab for nPM1300 on www.nordicsemi.com.

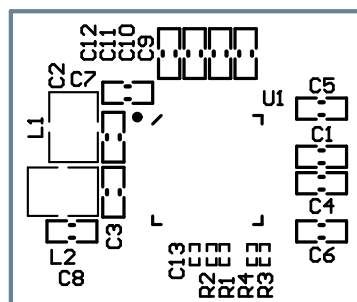

Figure 60: Top silkscreen layer QFN

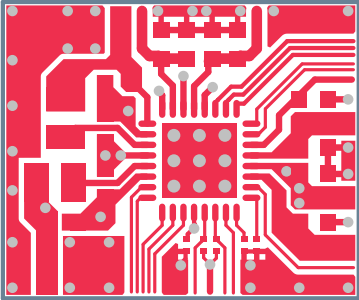

Figure 61: Top layer QFN

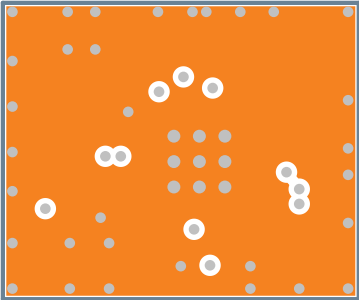

Figure 62: Mid layer 1 QFN

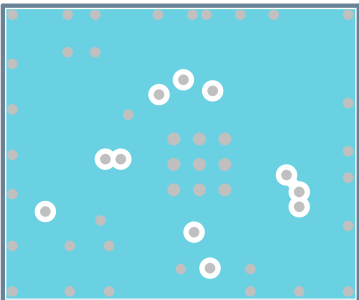

Figure 63: Mid layer 2 QFN

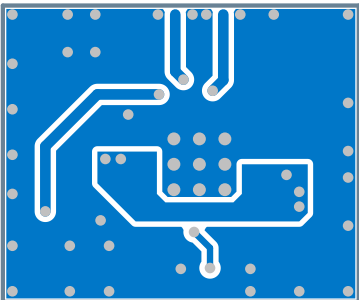

Figure 64: Bottom layer QFN

Note: No components on the bottom layer.

WLCSP PCB layout

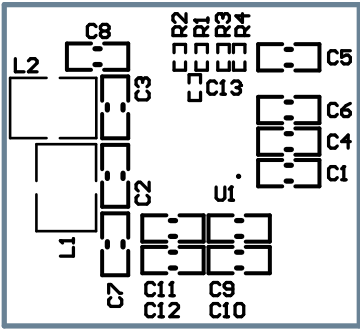

Figure 65: Top silkscreen layer WLCSP

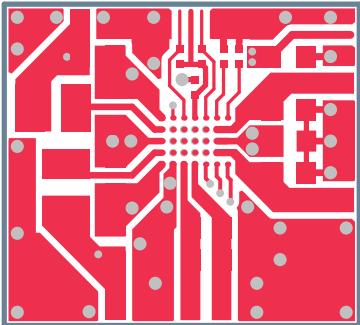

Figure 66: Top layer WLCSP

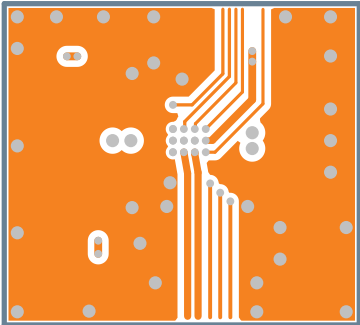

Figure 67: Mid layer 1 WLCSP

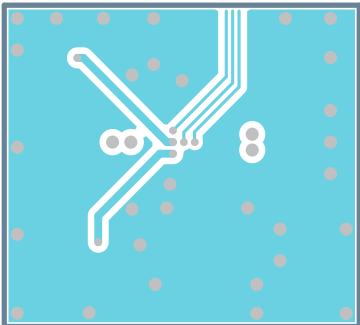

Figure 68: Mid layer 2 WLCSP

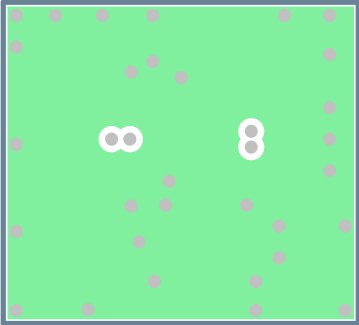

Figure 69: Mid layer 3 WLCSP

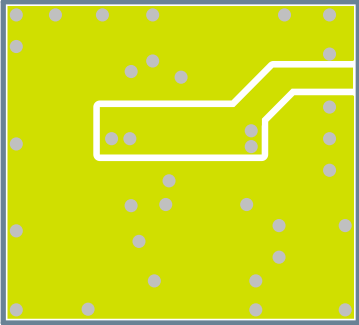

Figure 70: Mid layer 4 WLCSP

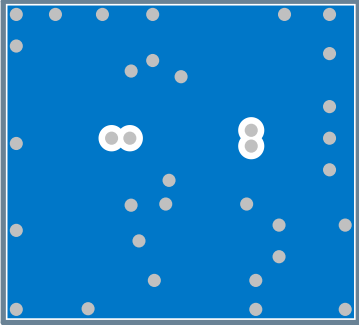

Figure 71: Bottom layer WLCSP

Note: No components are on the bottom layer.

10 Ordering information

This chapter contains information on IC marking, ordering codes, and container sizes.

10.1 IC marking

The nPM1300 PMIC package is marked as shown in the following figure.

N	P	M	1	3	0	0
<P	P>	<V	V>	<H>	<P>	
<Y	Y>	<W	W>	<L	L>	

Figure 72: IC marking

10.2 Box labels

The following figures define the box labels used for nPM1300.

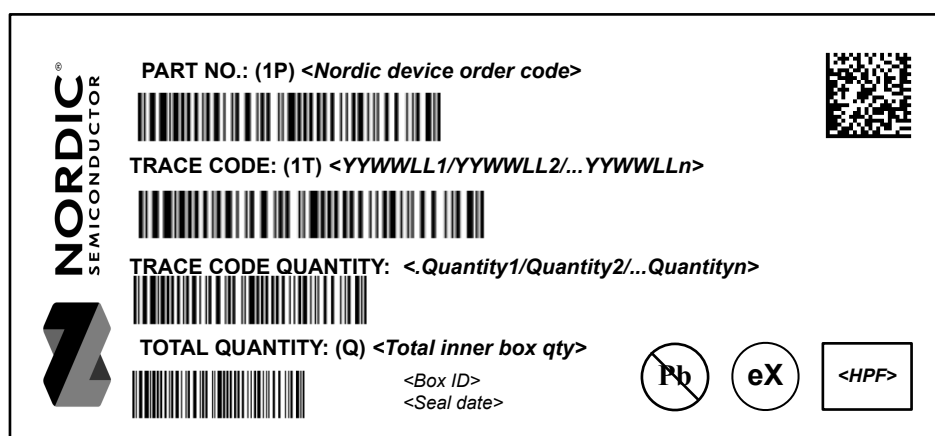

Figure 73: Inner box label







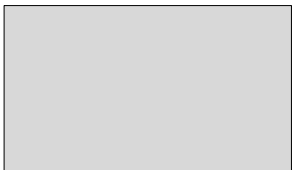
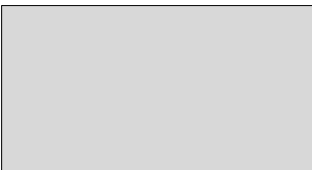

	
FROM: 	TO: 
PART NO: (1P) <Nordic device order code>  <div style="float: right; border: 1px solid black; padding: 2px;"> <H><P><F> </div>	
CUSTOMER PO NO: (K) <Customer Purchase Order No.>  <div style="float: right; border: 1px solid black; border-radius: 50%; padding: 5px; text-align: center;"> Pb </div>	
SALES ORDER NO: (14K) <Nordic Sales Order+Sales order line no.+ Delivery line no.> 	
SHIPMENT ID.: 2K <Nordic's shipment ID.> 	
QUANTITY: (Q) <Total quantity> 	
COUNTRY OF ORIGIN.: 4L <2-character code of COO> 	CARTON NO: x/n
DELIVERY NO.: (9K) <Shipper's shipment no.> 	GROSS WEIGHT: <div style="display: flex; align-items: center;"> <div style="border: 1px solid gray; width: 40px; height: 20px; margin-right: 5px;"></div> KGS </div> 

Figure 74: Outer box label

10.3 Order code

The following tables define nPM1300 order codes and definitions.

n	P	M	1	3	0	0	-	<P	P>	<V	V>	-	<C	C>
---	---	---	---	---	---	---	---	----	----	----	----	---	----	----

Figure 75: Order code

Abbreviation	Definition and implemented codes
nPM13	nPM13 series product
00	Part code
<PP>	Package variant code
<VV>	Function variant code
<H><P><F>	Build code H - Hardware version code P - Production configuration code (production site, etc.) F - Firmware version code (only visible on shipping container label)
<YY><WW><LL>	Tracking code YY - Year code WW - Assembly week number LL - Wafer lot code
<CC>	Container code
eX	2 nd level Interconnect Symbol where value of X is based on J-STD-609

Table 43: Abbreviations

10.4 Code ranges and values

The following tables define nPM1300 code ranges and values.

<PP>	Package	Size (mm)	Pin/Ball count	Pitch (mm)
CA	WLCSP	3.1x2.4	35	0.419 0.440
QE	QFN	5.0x5.0	32	0.5

Table 44: Package variant codes

<VV>	Flash (kB)	RAM (kB)
AA	n/a	n/a

Table 45: Function variant codes

<H>	Description
[A . . Z]	Hardware version/revision identifier (incremental)

Table 46: Hardware version codes

<P>	Description
[0 . . 9]	Production device identifier (incremental)
[A . . Z]	Engineering device identifier (incremental)

Table 47: Production configuration codes

<F>	Description
[A . . N, P . . Z]	Version of preprogrammed firmware
[0]	Delivered without preprogrammed firmware

Table 48: Production version codes

<YY>	Description
[16 . . 99]	Production year: 2016 to 2099

Table 49: Year codes

<WW>	Description
[1 . . 52]	Week of production

Table 50: Week codes

<LL>	Description
[AA . . ZZ]	Wafer production lot identifier

Table 51: Lot codes

<CC>	Description
R7	7" Reel
R	13" Reel

Table 52: Container codes

10.5 Product options

The following tables define nPM1300 product options.

Order code	MOQ ¹	Comment
nPM1300-CAAA-R	7000 pcs	
nPM1300-CAAA-R7	1500 pcs	
nPM1300-QEAA-R	4000 pcs	
nPM1300-QEAA-R7	1500 pcs	

Table 53: nPM1300 order codes

Order code	Description
nPM1300-EK	Evaluation kit
nPM-FG	Fuel gauge board

Table 54: Development tools order code

¹ Minimum Ordering Quantity

11 Legal notices

By using this documentation you agree to our terms and conditions of use. Nordic Semiconductor may change these terms and conditions at any time without notice.

Liability disclaimer

Nordic Semiconductor ASA reserves the right to make changes without further notice to the product to improve reliability, function, or design. Nordic Semiconductor ASA does not assume any liability arising out of the application or use of any product or circuits described herein.

Nordic Semiconductor ASA does not give any representations or warranties, expressed or implied, as to the accuracy or completeness of such information and shall have no liability for the consequences of use of such information. If there are any discrepancies, ambiguities or conflicts in Nordic Semiconductor's documentation, the Product Specification prevails.

Nordic Semiconductor ASA reserves the right to make corrections, enhancements, and other changes to this document without notice.

Customer represents that, with respect to its applications, it has all the necessary expertise to create and implement safeguards that anticipate dangerous consequences of failures, monitor failures and their consequences, and lessen the likelihood of failures that might cause harm, and to take appropriate remedial actions.

Nordic Semiconductor ASA assumes no liability for applications assistance or the design of customers' products. Customers are solely responsible for the design, validation, and testing of its applications as well as for compliance with all legal, regulatory, and safety-related requirements concerning its applications.

Nordic Semiconductor ASA's products are not designed for use in life-critical medical equipment, support appliances, devices, or systems where malfunction of Nordic Semiconductor ASA's products can reasonably be expected to result in personal injury. Customer may not use any Nordic Semiconductor ASA's products in life-critical medical equipment unless adequate design and operating safeguards by customer's authorized officers have been made. Customer agrees that prior to using or distributing any life-critical medical equipment that include Nordic Semiconductor ASA's products, customer will thoroughly test such systems and the functionality of such products as used in such systems.

Customer will fully indemnify Nordic Semiconductor ASA and its representatives against any damages, costs, losses, and/or liabilities arising out of customer's non-compliance with this section.

RoHS and REACH statement

Refer to for complete hazardous substance reports, material composition reports, and latest version of Nordic's RoHS and REACH statements.

Trademarks

All trademarks, service marks, trade names, product names, and logos appearing in this documentation are the property of their respective owners.

Copyright notice

© 2024 Nordic Semiconductor ASA. All rights are reserved. Reproduction in whole or in part is prohibited without the prior written permission of the copyright holder.



Looking for pricing, stock, or lifecycle information?

Click below to explore more details on WIN SOURCE:

- ⊖ [View NPM1300-CAAA-R7 on WIN SOURCE](#)
- ⊖ [Nordic Semiconductors Information](#)

Optimize Your Supply Chain with WIN SOURCE Solutions

- ✓ Global Sourcing Solution
- ✓ Obsolete Management
- ✓ Cost Control Management
- ✓ Shortage Management
- ✓ Alternative Solution
- ✓ Excess Inventory Management