



**THE DATASHEET OF  
ISL9204IRZ-T**



ISL9204

High Input Voltage Charger

FN9207  
Rev 0.00  
October 4, 2005

The ISL9204 is a cost-effective, fully integrated high input voltage single-cell Li-ion battery charger. This charger performs the CC/CV charge function required by Li-ion batteries. The charger accepts an input voltage up to 28V but is disabled when the input voltage exceeds the OVP threshold, minimum 10V, to prevent excessive power dissipation. The 28V rating eliminates the overvoltage protection circuit required in a low input voltage charger.

The charge current and the end-of-charge (EOC) current are programmable with external resistors. When the battery voltage is lower than a typical value of 2.8V, the charger preconditions the battery with typically 17% of the programmed charge current. When the charge current reduces to the programmable EOC current level during the CV charge phase, an EOC indication is provided by the CHG pin, which is an open-drain output. An internal thermal foldback function protects the charger from any thermal failure.

Two indication pins (PPR and CHG) allow simple interface to a microprocessor or LEDs. When no adapter is attached or when disabled, the charger draws less than 1µA leakage current from the battery.

**Ordering Information**

PART NUMBER	PART MARKING	TEMP. RANGE (°C)	PACKAGE	PKG. DWG. #
ISL9204IRZ-T (Note)	04Z	-40 to 85	8 Ld 2x3 DFN Tape and Reel (Pb-free)	L8.2x3

Intersil Pb-free plus anneal products employ special Pb-free material sets; molding compounds/die attach materials and 100% matte tin plate termination finish, which are RoHS compliant and compatible with both SnPb and Pb-free soldering operations. Intersil Pb-free products are MSL classified at Pb-free peak reflow temperatures that meet or exceed the Pb-free requirements of IPC/JEDEC J STD-020.

**Features**

- Complete Charger for Single-Cell Li-ion/Polymer Batteries
- Integrated Pass Element and Current Sensor
- No External Blocking Diode Required
- Low Component Count and Cost
- 1% Voltage Accuracy
- Programmable Charge Current
- **Programmable End-of-Charge Current**
- **Charge Current Thermal Foldback for Thermal Protection**
- Trickle Charge for Fully Discharged Batteries
- **28V Maximum Voltage for the Power Input**
- Power Presence and Charge Indications
- Less than 1µA Leakage Current Off the Battery when No Input Power Attached or Charger Disabled
- Ambient Temperature Range: -40°C to 85°C
- **2x3 DFN 8 Ld Packages**
- Pb-Free Plus Anneal Available (RoHS Compliant)

**Applications**

- Mobile Phones
- Blue-Tooth Devices
- PDAs
- MP3 Players
- Stand-alone Chargers
- Other Handheld Devices

**Pinout**

ISL9204  
(8 LD 2x3 DFN)  
TOP VIEW

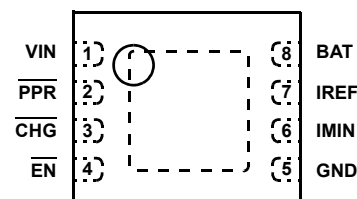

**Absolute Maximum Ratings (Reference to GND)**

VIN	-0.3V to 30V
IMIN, IREF, BAT, CHG, EN, PPR	-0.3V to 7V

**Recommended Operating Conditions**

Ambient Temperature Range	-40°C to 85°C
Maximum Supply Voltage (VIN Pin)	28V
Operating Supply Voltage (VIN Pin)	4.3V to 10V
Programmed Charge Current	50mA to 350mA

**CAUTION:** Stresses above those listed in "Absolute Maximum Ratings" may cause permanent damage to the device. This is a stress only rating and operation of the device at these or any other conditions above those indicated in the operational sections of this specification is not implied.

**NOTES:**

- $\theta_{JA}$  is measured in free air with the component mounted on a high effective thermal conductivity test board with "direct attach" features. See Tech Brief TB379.
- For theta  $\theta_{JC}$  the "case temp." location is the center of the exposed metal pad on the package underside.

**Thermal Information**

Thermal Resistance (Typical, Notes 1, 2)	$\theta_{JA}$ (°C/W)	$\theta_{JC}$ (°C/W)
DFN Package	59	4.5
Maximum Junction Temperature (Plastic Package)	150°C	
Maximum Storage Temperature Range	-65°C to 150°C	
Maximum Lead Temperature (Soldering 10s)	300°C (SOIC, PLCC, etc. Lead Tips Only)	

**Electrical Specifications** Typical Values Are Tested at VIN = 5V and the Ambient Temperature at 25°C. All Maximum and Minimum Values Are Guaranteed Under the Recommended Operating Supply Voltage Range and Ambient Temperature Range, Unless Otherwise Noted.

PARAMETER	SYMBOL	TEST CONDITIONS	MIN	TYP	MAX	UNITS
<b>POWER-ON RESET</b>						
Rising POR Threshold	V <sub>POR</sub>	V <sub>BAT</sub> = 3.0V, use PPR to indicate the comparator output.	3.3	3.9	4.3	V
Falling POR Threshold	V <sub>POR</sub>		3.1	3.6	4.15	V
<b>VIN-BAT OFFSET VOLTAGE</b>						
Rising Edge	V <sub>OS</sub>	V <sub>BAT</sub> = 4.0V, use CHG pin to indicate the comparator output (Note 3)	-	90	150	mV
Falling Edge	V <sub>OS</sub>		10	50	-	mV
<b>OVER VOLTAGE PROTECTION</b>						
Over Voltage Protection Threshold	V <sub>OVP</sub>	Use PPR to indicate the comparator output (Note 4)	10	10.5	13	V
OVP Threshold Hysteresis			200	400	500	mV
<b>STANDBY CURRENT</b>						
BAT Pin Sink Current	I <sub>STANDBY</sub>	Charger disabled or the input is floating	-	-	1.0	μA
VIN Pin Supply Current	I <sub>VIN</sub>	Charger disabled	-	300	400	μA
VIN Pin Supply Current	I <sub>VIN</sub>	Charger enabled	-	500	700	μA
<b>VOLTAGE REGULATION</b>						
Output Voltage	V <sub>CH</sub>	4.3V < V <sub>IN</sub> < 10V Charge current = 20mA	4.158	4.20	4.242	V
PMOS On Resistance	r <sub>DS(ON)</sub>	V <sub>BAT</sub> = 3.8V, charge current = 0.3A	-	0.6	-	Ω
<b>CHARGE CURRENT (Note 5)</b>						
IREF Pin Output Voltage	I <sub>IREF</sub>	V <sub>BAT</sub> = 3.8V	1.165	1.210	1.245	V
Constant Charge Current	I <sub>CHG</sub>	R <sub>IREF</sub> = 29.4kΩ, V <sub>BAT</sub> = 2.8V - 4.0V	135	150	165	mA
Trickle Charge Current	I <sub>TRK</sub>	R <sub>IREF</sub> = 29.4kΩ, V <sub>BAT</sub> = 2.4V	18	25	32	mA
End-of-Charge Current	I <sub>MIN</sub>	R <sub>IMIN</sub> = 137kΩ	20	30	40	mA
EOC Rising Threshold		R <sub>IREF</sub> = 29.4kΩ	90	110	130	mA
<b>PRECONDITIONING CHARGE THRESHOLD</b>						
Preconditioning Charge Threshold Voltage	V <sub>MIN</sub>		2.7	2.8	2.9	V
Preconditioning Voltage Hysteresis	V <sub>MINHYS</sub>		40	100	150	mV

**Electrical Specifications** Typical Values Are Tested at VIN = 5V and the Ambient Temperature at 25°C. All Maximum and Minimum Values Are Guaranteed Under the Recommended Operating Supply Voltage Range and Ambient Temperature Range, Unless Otherwise Noted. **(Continued)**

PARAMETER	SYMBOL	TEST CONDITIONS	MIN	TYP	MAX	UNITS
<b>INTERNAL TEMPERATURE MONITORING</b>						
Charge Current Foldback Threshold (Note 6)	T <sub>FOLD</sub>		100	115	130	°C
<b>LOGIC INPUT AND OUTPUTS</b>						
EN Pin Logic Input High			1.3	-	-	V
EN Pin Logic Input Low			-	-	0.5	V
EN Pin Internal Pull Down Resistance			100	200	400	kΩ
CHG Sink Current When LOW		Pin Voltage = 1V	10	20	-	mA
CHG Leakage Current When HIGH		V <sub>CHG</sub> = 6.5V	-	-	1	μA
PPR Sink Current When LOW		Pin Voltage = 1V	10	20	-	mA
PPR Leakage Current When HIGH		V <sub>PPR</sub> = 6.5V	-	-	1	μA

NOTES:

- The 4.0V V<sub>BAT</sub> is selected so that the CHG output can be used as the indication for the offset comparator output indication. If the V<sub>BAT</sub> is lower than the POR threshold, no output pin can be used for indication.
- For junction temperature from -40°C to 120°C.
- The charge current can be affected by the thermal foldback function if the IC under the test setup cannot dissipate the heat.
- Guaranteed by characterization or correlation to other test.

**Typical Characteristics**

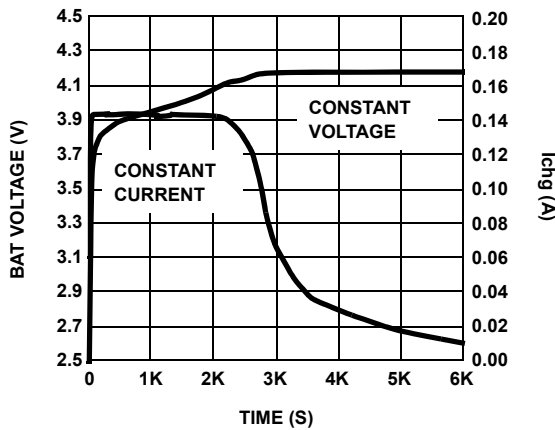

FIGURE 1. COMPLETE CHARGE CYCLE (130mAh BATTERY)

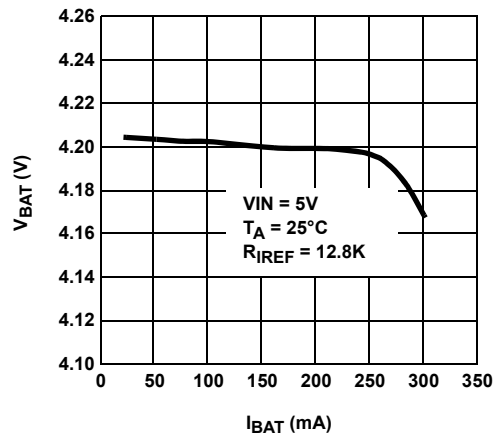

FIGURE 2. CONSTANT VOLTAGE vs CHARGE CURRENT

**Typical Characteristics** (Continued)

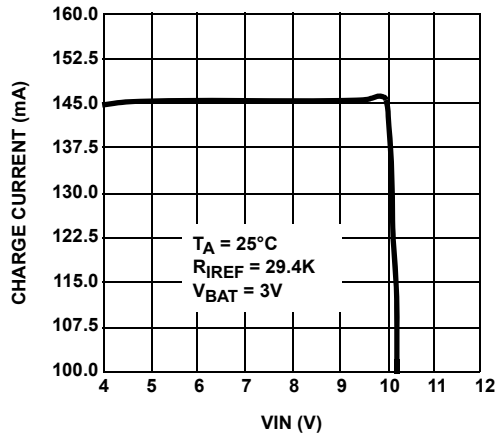

FIGURE 3. CHARGE CURRENT vs VIN

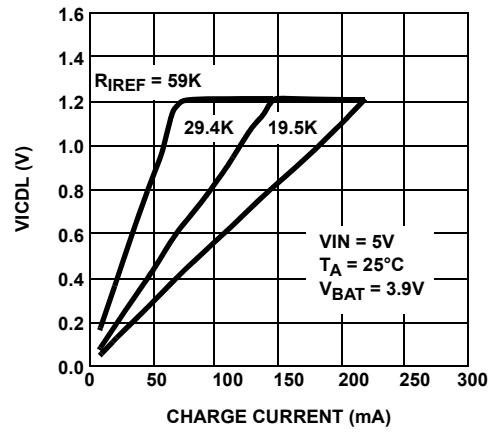

FIGURE 4. VICDL vs CHARGE CURRENT

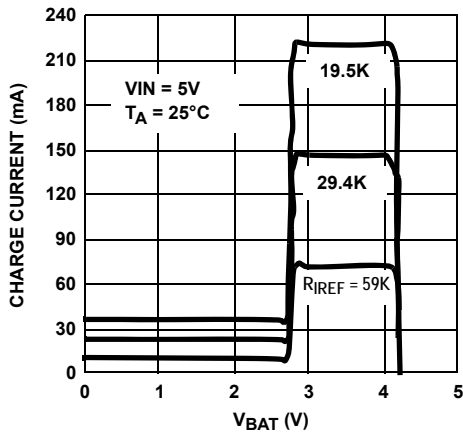

FIGURE 5. CHARGE CURRENT vs VBAT

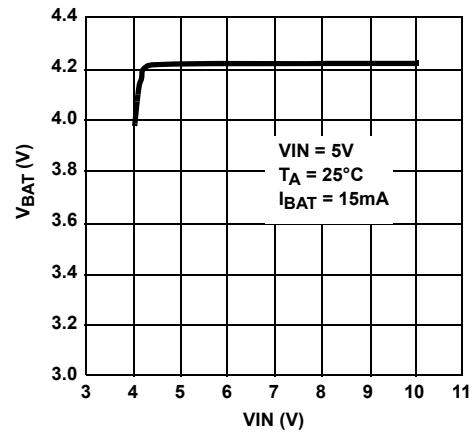

FIGURE 6. VBAT vs VIN

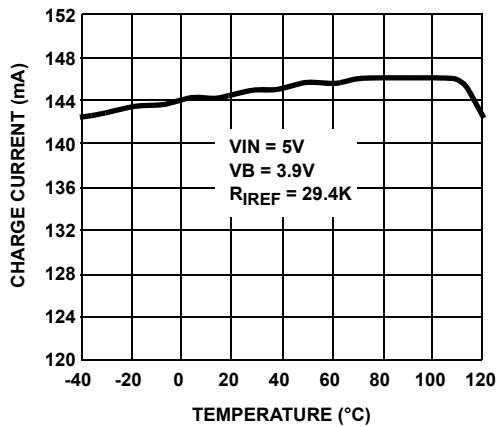

FIGURE 7. CHARGE CURRENT vs TEMPERATURE

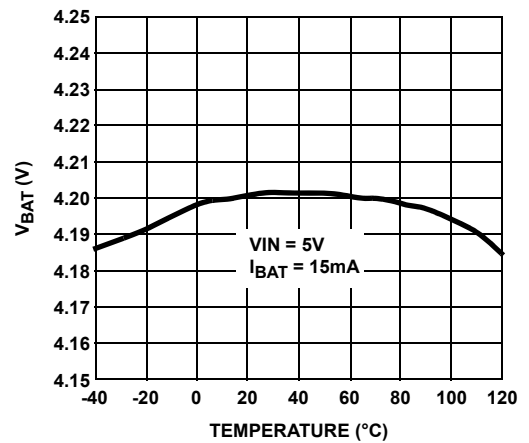

FIGURE 8. VBAT vs TEMPERATURE

## Pin Descriptions

**VIN** - Power input. The absolute maximum input voltage is 28V. A 0.47 $\mu$ F or larger value X5R ceramic capacitor is recommended to be placed very close to the input pin for decoupling purpose. Additional capacitance may be required to provide a stable input voltage.

**PPR** - Open-drain power presence indication. The open-drain MOSFET turns on when the input voltage is above the POR threshold but below the OVP threshold and off otherwise. This pin is capable to sink 10mA (minimum) current to drive a LED. The maximum voltage rating for this pin is 7V. This pin is independent on the EN-pin input.

**CHG** - Open-drain charge indication pin. This pin outputs a logic LOW when a charge cycle starts and turns to HIGH when the end-of-charge (EOC) condition is qualified. This pin is capable to sink 10mA min. current to drive an LED. When the charger is disabled, the CHG outputs high impedance.

**EN** - Enable input. This is a logic input pin to disable or enable the charger. Drive to HIGH to disable the charger. When this pin is driven to LOW or left floating, the charger is enabled. This pin has an internal 200k $\Omega$  pull-down resistor.

**GND** - System ground.

**IMIN** - End-of-charge (EOC) current program pin. Connect a resistor between this pin and the GND pin to set the EOC

current. The EOC current  $I_{MIN}$  can be programmed by the following equation:

$$I_{MIN} = \frac{4180}{R_{IMIN}} \quad (\text{mA})$$

Where  $R_{IMIN}$  is in k $\Omega$ . The programmable range covers 5% (or 10mA, whichever is higher) to 50% of  $I_{REF}$ . When programmed to less than 5% or 10mA, the stability is not guaranteed.

**IREF** - Charge-current program and monitoring pin. Connect a resistor between this pin and the GND pin to set the charge current limit determined by the following equation:

$$I_{REF} = \frac{4400}{R_{IREF}} \quad (\text{mA})$$

Where  $R_{IREF}$  is in k $\Omega$ . The IREF pin voltage also monitors the actual charge current during the entire charge cycle, including the trickle, constant-current, and constant-voltage phases. When disabled,  $V_{IREF} = 0V$ .

**BAT** - Charger output pin. Connect this pin to the battery. A 1 $\mu$ F or larger X5R ceramic capacitor is recommended for decoupling and stability purposes. When the EN pin is pulled to logic HIGH, the BAT output is disabled.

**EPAD** - Exposed pad. Connect as much as possible copper to this pad either on the component layer or other layers through thermal vias to enhance the thermal performance.

## Typical Application

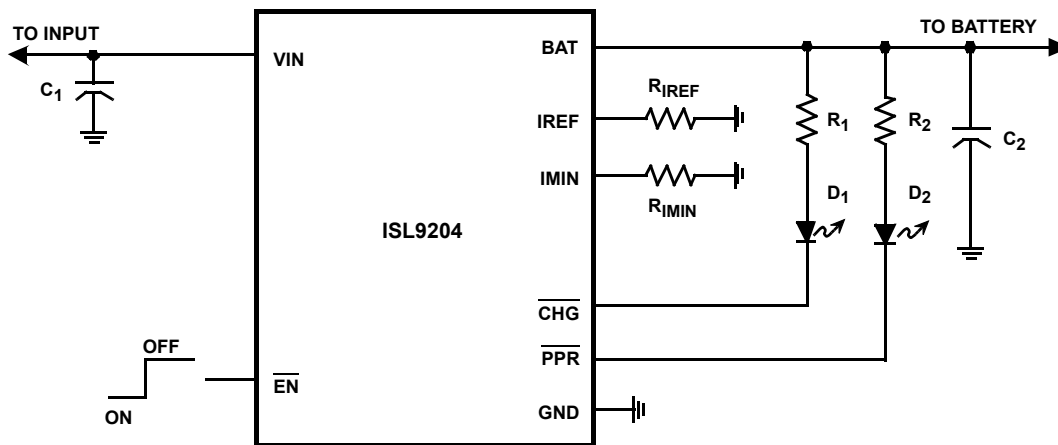

FIGURE 9. TYPICAL APPLICATION CIRCUIT INTERFACING TO INDICATION LEDs



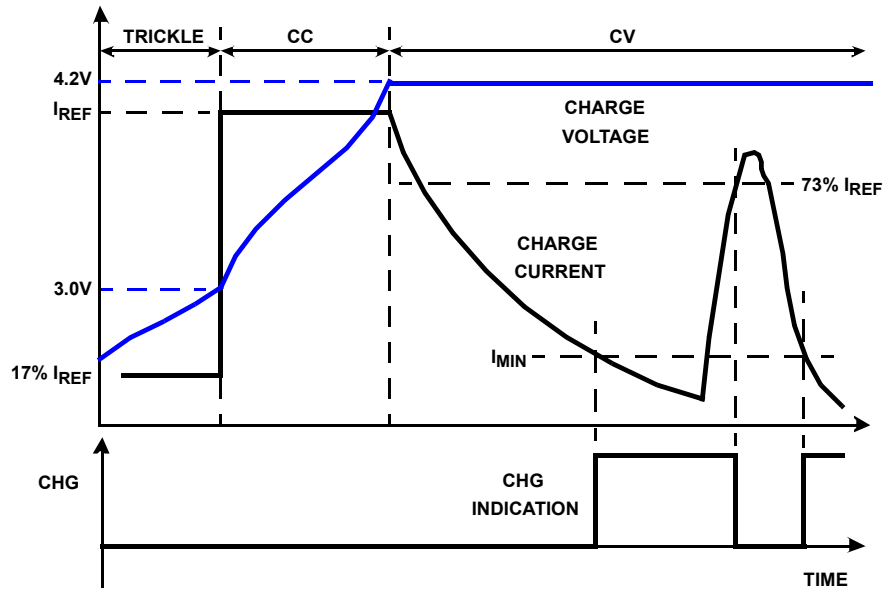

FIGURE 12. TYPICAL CHARGE PROFILE

### Description

The ISL9204 charges a Li-ion battery with a constant current (CC) or a constant voltage (CV). The constant current  $I_{REF}$  is set with the external resistor  $R_{IREF}$  (see Figure 9) and the constant voltage is fixed at 4.2V. If the battery voltage is below a typical 2.8V trickle-charge threshold, the ISL9204 charges the battery with a trickle current until the battery voltage rises above the trickle charge threshold. When the battery voltage reaches 4.2V, the charger enters a CV mode and regulates the battery voltage at 4.2V to fully charge the battery without the risk of over charge. Upon reaching an end-of-charge (EOC) current, the charger indicates the charge completion with the CHG pin, but the charger continues to output the 4.2V voltage. Figure 12 shows the typical charge profile and the EOC/reset event.

The EOC current level  $I_{MIN}$  is programmable with the external resistor  $R_{IMIN}$  (see Figure 9). The CHG signal turns to LOW when the trickle charge starts and rises to HIGH at the EOC. After the EOC is reached, the charge current has to rise to typically 73%  $I_{REF}$  for the CHG signal to turn on again, as shown in Figure 12. The current surge after EOC can be caused by a load connected to the battery.

A thermal foldback function reduces the charge current anytime when the die temperature reaches typically 115°C. This function guarantees safe operation when the printed-circuit board (PCB) is not capable of dissipating the heat generated by the linear charger. The ISL9204 accepts an input voltage up to 28V but disables charging when the input voltage exceeds the OVP threshold, minimum 10V, to protect against unqualified or faulty AC adapters.

### PPR Indication

The PPR pin is an open-drain output to indicate the presence of the AC adapter. Whenever the input voltage is

higher than the POR threshold, the PPR pin turns on the internal open-drain MOSFET to indicate a logic LOW signal, independent on the EN-pin input. When the internal open-drain FET is turned off, the PPR pin should leak less than 1 $\mu$ A current. When turned on, the PPR pin should be able to sink at least 10mA current under all operating conditions.

The PPR pin can be used to drive an LED (see Figure 9) or to interface with a microprocessor.

### Power-Good Range

The power-good range is defined by the following three conditions:

1.  $V_{IN} > V_{POR}$
2.  $V_{IN} - V_{BAT} > V_{OS}$
3.  $V_{IN} < V_{OVP}$

where the  $V_{OS}$  is the offset voltage for the input and output voltage comparator, discussed shortly, and the  $V_{OVP}$  is the overvoltage protection threshold given in the Electrical Specification. All  $V_{POR}$ ,  $V_{OS}$ , and  $V_{OVP}$  have hysteresis, as given in the Electrical Specification table. The charger will not charge the battery if the input voltage is not in the power-good range.

### Input and Output Comparator

The charger will not be enabled unless the input voltage is higher than the battery voltage by an offset voltage  $V_{OS}$ . The purpose of this comparator is to ensure that the charger is turned off when the input power is removed from the charger. Without this comparator, it is possible that the charger will fail to power down when the input is removed and the current can leak through the PFET pass element to continue biasing the POR and the Pre-Regulator blocks shown in the Block Diagram.

**CHG Indication**

The CHG is an open-drain output capable to at least 10mA current when the charger starts to charge and turns off when the EOC current is reached. The CHG signal is interfaced either with a micro-processor GPIO or an LED for indication.

**EN Input**

EN is an active-low logic input to enable the charger. Drive the EN pin to LOW or leave it floating to enable the charger. This pin has a 200k $\Omega$  internal pulldown resistor so when left floating, the input is equivalent to logic LOW. Drive this pin to HIGH to disable the charger. The threshold for HIGH is given in the ES (Electrical Specification) table.

**IREF Pin**

The IREF pin has the two functions as described in the Pin Description section. When setting the fast charge current, the charge current is guaranteed to have 10% accuracy with the charge current set at 150mA. When monitoring the charge current, the accuracy of the IREF pin voltage vs. the actual charge current has the same accuracy as the gain from the IREF pin current to the actual charge current. The accuracy is 10% at 150mA and is expected to drop to 30% of the actual current (not the set constant charge current) when the current drops to 50mA.

**Operation Without the Battery**

The ISL9204 relies on a battery for stability and is not guaranteed to be stable if the battery is not connected. With a battery, the charger will be stable with an output ceramic decoupling capacitor in the range of 1 $\mu$ F to 200 $\mu$ F. The maximum load current is limited by the dropout voltage or the thermal foldback.

**Dropout Voltage**

The constant current may not be maintained due to the  $r_{DS(ON)}$  limit at a low input voltage. The worst case on resistance of the pass FET is 1.2 $\Omega$  the maximum operating temperature, thus if tested with 350mA current and 4.2V battery voltage, constant current could not be maintained when the input voltage is below 4.62V.

**Thermal Foldback**

The thermal foldback function starts to reduce the charge current when the internal temperature reaches a typical value of 115°C.

**Applications Information****Input Capacitor Selection**

The input capacitor is required to suppress the power supply transient response during transitions. Mainly this capacitor is selected to avoid oscillation during the start up when the input supply is passing the POR threshold and the VIN-BAT comparator offset voltage. When the battery voltage is above the POR threshold, the VIN-VBAT offset voltage dominates the hysteresis value. Typically, a 1 $\mu$ F X5R ceramic capacitor should be sufficient to suppress the power supply noise.

**Output Capacitor Selection**

The criteria for selecting the output capacitor is to maintain the stability of the charger as well as to bypass any transient load current. The minimum capacitance is a 1 $\mu$ F X5R ceramic capacitor. The actual capacitance connected to the output is dependent on the actual application requirement.

**Charge Current Limit**

The actual charge current in the CC mode is limited by several factors in addition to the set  $I_{REF}$ . Figure 13 shows three limits for the charge current in the CC mode. The charge current is limited by the on resistance of the pass element (power P-channel MOSFET) if the input and the output voltage are too close to each other. The solid curve shows a typical case when the battery voltage is 4.0V and the charge current is set to 350mA. The non-linearity on the  $R_{ON}$ -limited region is due to the increased resistance at higher die temperature. If the battery voltage increases to higher than 4.0V, the entire curve moves towards right side. As the input voltage increases, the charge current may be reduced due to the thermal foldback function. The limit caused by the thermal limit is dependent on the thermal impedance. As the thermal impedance increases, the thermal-limited curve moves towards left, as shown in Figure 13.

**Layout Guidance**

The ISL9204 uses a thermally-enhanced DFN package that has an exposed thermal pad at the bottom side of the package. The layout should connect as much as possible to copper on the exposed pad. Typically the component layer is more effective in dissipating heat. The thermal impedance can be further reduced by using other layers of copper connecting to the exposed pad through a thermal via array. Each thermal via is recommended to have 0.3mm diameter and 1mm distance from other thermal vias.

## Input Power Sources

The input power source is typically a well-regulated wall cube with 1-meter length wire or a USB port. The input voltage ranges from 4.3V to 10V. The ISL9204 can withstand up to 28V on the input without damaging the IC. If the input voltage is higher than the OVP threshold, the charger stops charging.

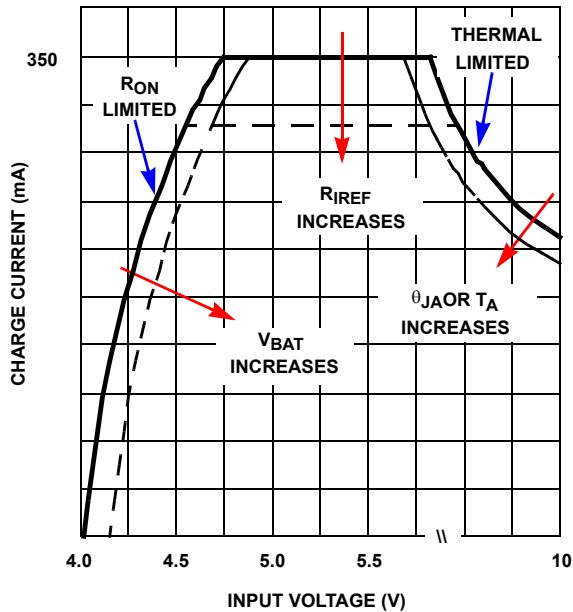

FIGURE 13. CHARGE CURRENT LIMITS IN CONSTANT CURRENT MODE

© Copyright Intersil Americas LLC 2005. All Rights Reserved.

All trademarks and registered trademarks are the property of their respective owners.

For additional products, see [www.intersil.com/en/products.html](http://www.intersil.com/en/products.html)

Intersil products are manufactured, assembled and tested utilizing ISO9001 quality systems as noted in the quality certifications found at [www.intersil.com/en/support/qualandreliability.html](http://www.intersil.com/en/support/qualandreliability.html)

*Intersil products are sold by description only. Intersil may modify the circuit design and/or specifications of products at any time without notice, provided that such modification does not, in Intersil's sole judgment, affect the form, fit or function of the product. Accordingly, the reader is cautioned to verify that datasheets are current before placing orders. Information furnished by Intersil is believed to be accurate and reliable. However, no responsibility is assumed by Intersil or its subsidiaries for its use; nor for any infringements of patents or other rights of third parties which may result from its use. No license is granted by implication or otherwise under any patent or patent rights of Intersil or its subsidiaries.*

For information regarding Intersil Corporation and its products, see [www.intersil.com](http://www.intersil.com)

Dual Flat No-Lead Plastic Package (DFN)

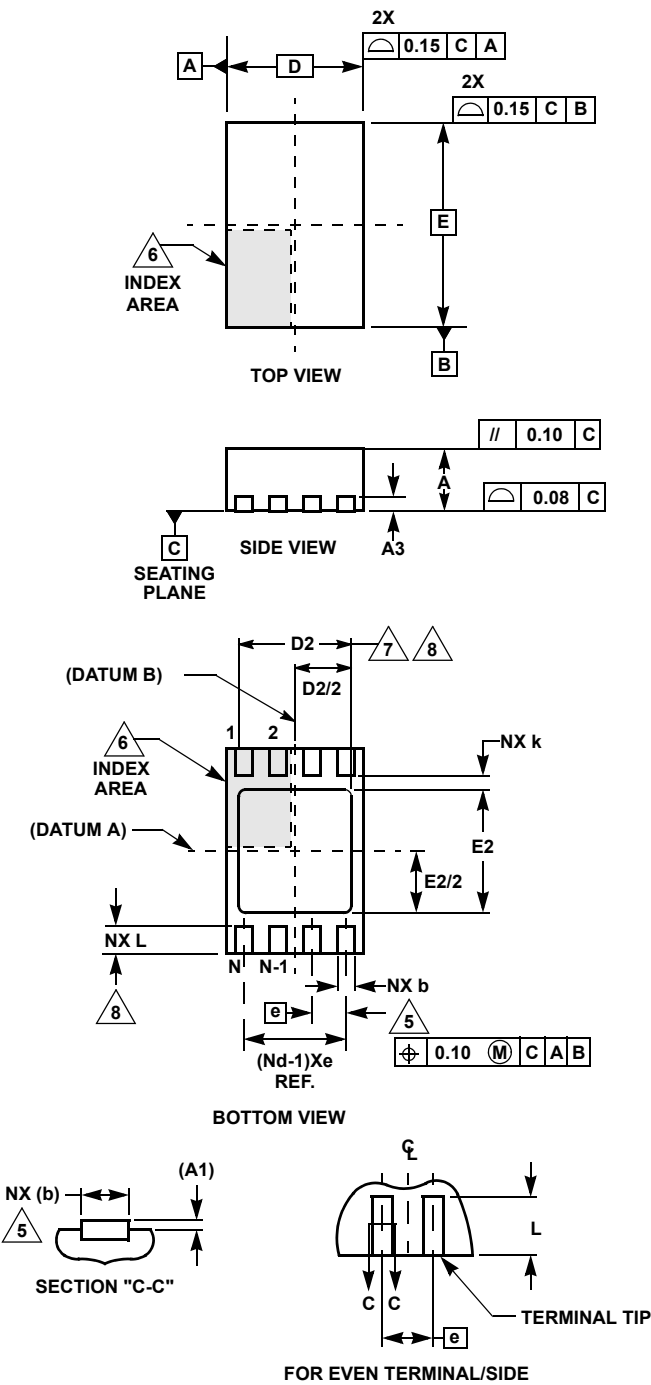

L8.2x3

8 LEAD DUAL FLAT NO-LEAD PLASTIC PACKAGE

SYMBOL	MILLIMETERS			NOTES
	MIN	NOMINAL	MAX	
A	0.80	0.90	1.00	-
A1	-	-	0.05	-
A3	0.20 REF			-
b	0.20	0.25	0.32	5,8
D	2.00 BSC			-
D2	1.50	1.65	1.75	7,8
E	3.00 BSC			-
E2	1.65	1.80	1.90	7,8
e	0.50 BSC			-
k	0.20	-	-	-
L	0.30	0.40	0.50	8
N	8			2
Nd	4			3

Rev. 0 6/04

NOTES:

1. Dimensioning and tolerancing conform to ASME Y14.5-1994.
2. N is the number of terminals.
3. Nd refers to the number of terminals on D.
4. All dimensions are in millimeters. Angles are in degrees.
5. Dimension b applies to the metallized terminal and is measured between 0.25mm and 0.30mm from the terminal tip.
6. The configuration of the pin #1 identifier is optional, but must be located within the zone indicated. The pin #1 identifier may be either a mold or mark feature.
7. Dimensions D2 and E2 are for the exposed pads which provide improved electrical and thermal performance.
8. Nominal dimensions are provided to assist with PCB Land Pattern Design efforts, see Intersil Technical Brief TB389.

## Looking for pricing, stock, or lifecycle information?

Click below to explore more details on WIN SOURCE:

 [View ISL9204IRZ-T on WIN SOURCE](#)

 [Intersil Information](#)

## Optimize Your Supply Chain with WIN SOURCE Solutions

-  Global Sourcing Solution
-  Obsolete Management
-  Cost Control Management
-  Shortage Management
-  Alternative Solution
-  Excess Inventory Management