



**THE DATASHEET OF
ISL59920IRZ-T7**



ISL59920, ISL59921, ISL59922, ISL59923

Triple Analog Video Delay Lines

FN6826
Rev 4.00
August 27, 2015

The ISL59920, ISL59921, ISL59922, and ISL59923 are triple analog delay lines that provide skew compensation between three high-speed signals. These parts are ideal for compensating for the skew introduced by a typical CAT-5, CAT-6 or CAT-7 cable (with differing electrical lengths on each twisted pair) when transmitting analog video.

Using a simple serial interface, the ISL59920, ISL59921, ISL59922, and ISL59923's delays are programmable in steps of 2, 1.5, 1, or 2ns (respectively) for up to a total delay of 62, 46.5, 31, or 30ns (respectively) on each channel. The gain of the video amplifiers can be set to x1 (0dB) or x2 (6dB) for back-termination. The delay lines require a $\pm 5V$ supply.

Features

- 30, 31, 46.5, or 62ns Total delay
- 1.0, 1.5, or 2.0ns Delay step increments
- Very low offset voltage
- Drop-in compatible with the EL9115
- Low power consumption
- 20 Ld QFN package
- Pb-Free (RoHS compliant)

Applications

- Skew control for RGB video signals
- Generating programmable high-speed analog delays

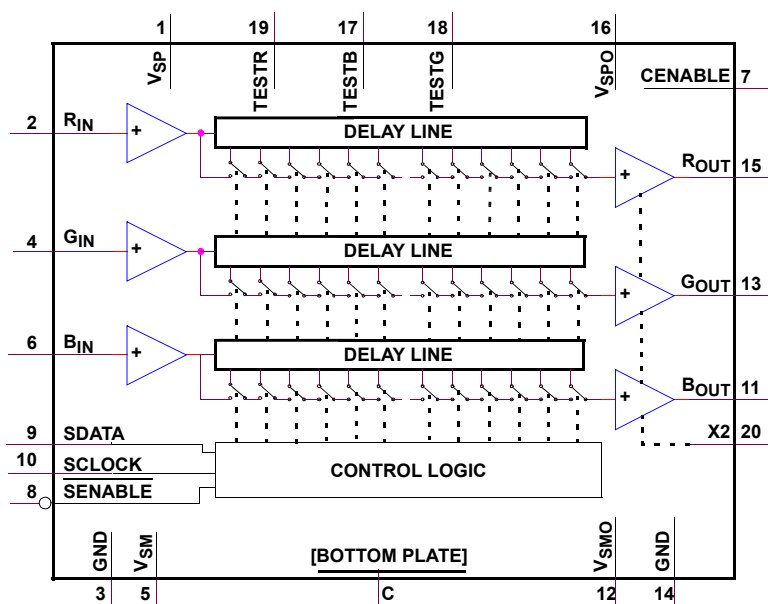

FIGURE 1. ISL59920, ISL59921, ISL59922, ISL59923 BLOCK DIAGRAM

Ordering Information

PART NUMBER (Notes 1, 2, 3)	PART MARKING	MAX DELAY (ns)	DELAY STEP SIZE (ns)	TYPICAL POWER DISSIPATION (mW)	PACKAGE (RoHS Compliant)	PKG. DWG. #
ISL59920IRZ	59920 IRZ	62	2.0	645	20 Ld 5mmx5mm QFN	L20.5x5C
ISL59921IR (No longer available or supported)	59921 IRZ	46.5	1.5	645	20 Ld 5mmx5mm QFN	L20.5x5C
ISL59922IRZ(No longer available or supported)	59922 IRZ	31	1.0	645	20 Ld 5mmx5mm QFN	L20.5x5C
ISL59923IRZ(No longer available or supported)	59923 IRZ	30	2.0	540	20 Ld 5mmx5mm QFN	L20.5x5C

NOTES:

1. Add "-T*" suffix for tape and reel. Please refer to TB347 for details on reel specifications.
2. These Intersil Pb-free plastic packaged products employ special Pb-free material sets, molding compounds/die attach materials, and 100% matte tin plate plus anneal (e3 termination finish, which is RoHS compliant and compatible with both SnPb and Pb-free soldering operations). Intersil Pb-free products are MSL classified at Pb-free peak reflow temperatures that meet or exceed the Pb-free requirements of IPC/JEDEC J STD-020.
3. For Moisture Sensitivity Level (MSL), please see product information pages for [ISL59920](#), [ISL59921](#), [ISL59922](#), [ISL59923](#). For more information on MSL, please see tech brief [TB363](#)

Pin Configuration

ISL59920, ISL59921, ISL59922, ISL59923
(20 LD 5x5 QFN)

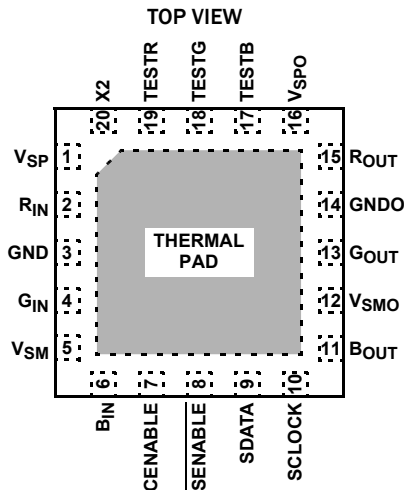

Pin Descriptions

PIN NUMBER	PIN NAME	PIN DESCRIPTION
1	V _{SP}	+5V for delay circuitry and input amp
2	R _{IN}	Red channel video input
3	GND	0V for delay circuitry supply
4	G _{IN}	Green channel video input
5	V _{SM}	-5V for input amp
6	B _{IN}	Blue channel video input
7	CENABLE	Chip Enable input, active high: logical high enables chip, low disables chip. This pin should be low at power-on until at least 30ms after the power supply has settled to within 5% of its final value. For more information, see " CENABLE at Power-On " on page 16 .
8	SENABLE	Serial Enable input, active low: logical low enables serial communication
9	SDATA	Serial Data input, logic threshold 1.2V: data to be programmed into chip

Pin Descriptions (Continued)

PIN NUMBER	PIN NAME	PIN DESCRIPTION
10	SCLOCK	Serial Clock input: Clock to enter data; logical; data written on negative edge
11	BOUT	Blue channel video output
12	VSMO	-5V for video output buffers
13	GOUT	Green channel video output
14	GNDO	0V reference for input and output buffers
15	ROUT	Red channel video output
16	VSP0	+5V for video output buffers
17	TESTB	Blue channel phase detector output
18	TESTG	Green channel phase detector output
19	TESTR	Red channel phase detector output
20	X2	Gain Select Input: logical high = 2x (+6dB), logical low = 1x (0dB)
Thermal Pad		MUST be tied to -5V. For best thermal conductivity, tie to a larger -5V copper plane (inner or bottom). Use many vias to minimize thermal resistance between thermal pad and copper plane. Do not connect to GND - connection to GND is equivalent to shorting the -5V and GND planes together.

Absolute Maximum Ratings ($T_A = +25^\circ\text{C}$)

Supply Voltage (V_S+ to V_S-)	12V
Maximum Output Current	$\pm 60\text{mA}$
Storage Temperature Range	-65°C to $+150^\circ\text{C}$
ESD Classification	
Human Body Model	3000V
Machine Model	300V
Charged Device Model	1200V

Thermal Information

Thermal Resistance (Typical)	θ_{JA} ($^\circ\text{C}/\text{W}$)	θ_{JC} ($^\circ\text{C}/\text{W}$)
20 Lead QFN (Notes 4, 5)	31	2
Pb-Free Reflow Profile	see TB493	

Recommended Operating Conditions

Operating Junction Temperature	$+135^\circ\text{C}$
Ambient Operating Temperature	-40°C to $+85^\circ\text{C}$

CAUTION: Do not operate at or near the maximum ratings listed for extended periods of time. Exposure to such conditions may adversely impact product reliability and result in failures not covered by warranty.

NOTE:

- θ_{JA} is measured in free air with the component mounted on a high effective thermal conductivity test board with “direct attach” features. See Tech Brief [TB379](#).
- For θ_{JC} , the “case temp” location is the center of the exposed metal pad on the package underside.

Electrical Specifications $V_{SP} = V_{SP0} = +5\text{V}$, $V_{SM} = V_{SMP} = -5\text{V}$, $\text{GAIN} = 2$, $T_A = +25^\circ\text{C}$, exposed die plate = -5V , $x2 = 5\text{V}$, $R_{LOAD} = 150\Omega$ on all video outputs, unless otherwise specified.

PARAMETER	DESCRIPTION	TEST CONDITIONS	MIN (Note 6)	TYP	MAX (Note 6)	UNITS
d_t	Nominal Delay Increment (Note 7)	ISL59920	1.8	2	2.2	ns
		ISL59921	1.4	1.5	1.7	ns
		ISL59922	0.9	1	1.2	ns
		ISL59923	1.8	2	2.3	ns
t_{MAX}	Maximum Delay	ISL59920	55	62	68	ns
		ISL59921	42.5	46.5	53.5	ns
		ISL59922	26.5	31	38.5	ns
		ISL59923	26.5	30	34.5	ns
D_{ELDT}	Delay Difference Between Channels for Same Delay Settings On All Channels			1		ns
t_{PD}	Propagation Delay	ISL59920, ISL59923, measured input to output, delay setting = 0ns		10		ns
		ISL59921, measured input to output, delay setting = 0ns		8		ns
		ISL59922, measured input to output, delay setting = 0ns		7		ns
BW -3dB	3dB Bandwidth, 0ns Delay Time	ISL59920, ISL59923		153		MHz
		ISL59921		200		MHz
		ISL59922		230		MHz
BW $\pm 0.1\text{dB}$	$\pm 0.1\text{dB}$ Bandwidth, 0ns Delay Time	ISL59920, ISL59923		50		MHz
		ISL59921		60		MHz
		ISL59922		50		MHz
SR	Slew Rate	ISL59920, 20 to 80, delay = 0ns		550		V/ μs
		ISL59921, 20 to 80, delay = 0ns		640		V/ μs
		ISL59922, 20 to 80, delay = 0ns		700		V/ μs
		ISL59923; 20 to 80, delay = 0ns		550		V/ μs

Electrical Specifications $V_{SP} = V_{SP0} = +5V$, $V_{SM} = V_{SMP} = -5V$, GAIN = 2, $T_A = +25^\circ C$, exposed die plate = -5V, $x_2 = 5V$, $R_{LOAD} = 150\Omega$ on all video outputs, unless otherwise specified. (Continued)

PARAMETER	DESCRIPTION	TEST CONDITIONS	MIN (Note 6)	TYP	MAX (Note 6)	UNITS
$t_R - t_F$	Transient Response Time	ISL59920, 20% to 80%, for any delay, 1V step delay = 0ns		1.7		ns
		ISL59921, 20% to 80%, for any delay, 1V step delay = 0ns		1.6		ns
		ISL59922, 20% to 80%, for any delay, 1V step delay = 0ns		1.43		ns
		ISL59923, 20% to 80%, for any delay, 1V step delay = 0ns		1.7		ns
V_{OVER}	Voltage Overshoot	For any delay, response to 1V step input		4		%
Settling Time	Output Settling after Delay Change / Offset Calibration	Output settling time from rising edge of SENABLE		3		μs
THD	Total Harmonic Distortion	1V _{p,p} 10MHz sinewave, offset by +0.2V at mid delay setting		-43	-38	dB
X	Crosstalk	Stimulate G, measure R/B at 1MHz, ISL59920, ISL59921, ISL59923		-80	-63	dB
		ISL59922		-78	-59	dB
V_N	Output Noise	Bandwidth = 150MHz		2		mV _{RMS}
G_0	Gain Zero Delay		1.74	1.8	1.92	V/V
G_m	Gain Mid Delay		1.67	1.8	1.97	V/V
G_f	Gain Full Delay		1.6	1.8	2	V/V
DG _{m0}	Difference in Gain, 0 to Mid		-8	0.6	7.5	%
DG _{f0}	Difference in Gain, 0 to Full		-12	-1.8	10	%
DG _{fm}	Difference in Gain, Mid to Full		-10	-1.7	7.5	%
V_{IN}	Input Voltage Range	ISL59920, Gain remains > 90% of nominal, Gain = 2	-0.7		1.1	V
		ISL59921, Gain remains > 90% of nominal, Gain = 2	-0.7		1.04	V
		ISL59922, Gain remains > 90% of nominal, Gain = 2	-0.7		1.04	V
		ISL59923, Gain remains > 90% of nominal, Gain = 2	-0.7		1.15	V
I_B	R_{IN} , G_{IN} , B_{IN} Input Bias Current	ISL59920, ISL59921	3	6	8	μA
		ISL59922, ISL59923	1.5		8	μA
V_{OS}	Output Offset Voltage	Post offset calibration (Note 9), Delay = 0ns and Delay = Full	-25	-4	+20	mV
Z_{OUT}	Output Impedance	ISL59920, ISL59921, Enabled, Chip enable = 5V	4.5	5.4	6.3	Ω
		ISL59922, ISL59923, Enabled, Chip enable = 5V	3.5		6.3	Ω
		Disabled, Chip enable = 0V		8		M Ω
+PSRR	Rejection of Positive Supply			-42	-29	dB
-PSRR	Rejection of Negative Supply			-58	-46	dB
I_{OUT}	Output Drive Current	10 Ω load, 0.5V drive	43	53	70	mA
V_{IH}	Logic High	Switch high threshold			1.6	V
V_{IL}	Logic Low	Switch low threshold	0.8			V

Electrical Specifications $V_{SP} = V_{SP0} = +5V$, $V_{SM} = V_{SMP} = -5V$, GAIN = 2, $T_A = +25^\circ C$, exposed die plate = -5V, x2 = 5V, $R_{LOAD} = 150\Omega$ on all video outputs, unless otherwise specified. (Continued)

PARAMETER	DESCRIPTION	TEST CONDITIONS	MIN (Note 6)	TYP	MAX (Note 6)	UNITS
POWER SUPPLY CHARACTERISTICS						
V+	V_{SP} , V_{SP0} Positive Supply Range		+4.5		+5.5	V
V-	V_{SM} , V_{SM0} Negative Supply Range		-4.5		-5.5	V
I _{SP}	Positive Supply Current (Note 8)	ISL59920	98	115	127	mA
		ISL59921, ISL59922	98	125	146	mA
		ISL59923	74	90	106	mA
I _{SP0}	Positive Output Supply Current (Note 8)	ISL59920	11.3	13	15.3	mA
		ISL59921, ISL59922	11.3	13	16.3	mA
		ISL59923	9.9	13	16	mA
I _{SM}	Negative Supply Current (Note 8)		-35.45	-31	-26	mA
I _{SM0}	Negative Output Supply Current (Note 8)	ISL59920, ISL59921, ISL59922	-15.5	-13	-11	mA
		ISL59923	-17.5	-13	-9.5	mA
ΔI_{SP}	Supply Current (Note 8)	Increase in I _{SP} per unit step in delay per channel		0.9		mA
I _{STANDBY}	Positive Supply Standby Current (Note 8)	Chip enable = 0V		2.6		mA
SERIAL INTERFACE CHARACTERISTICS						
t _{MAX}	Max SCLOCK Frequency	Maximum programming clock speed			10	MHz
t _{SEN_SETUP}	$\overline{SENABLE}$ to SCLOCK falling edge setup time. (see Figure 35).	$\overline{SENABLE}$ falling edge should occur at least t _{SEN_SETUP} ns after previous (ignored) clock and t _{SEN_SETUP} before next (desired) clock. Clock edges occurring within t _{en_ck} of the $\overline{SENABLE}$ falling edge will have indeterminate effect.		10		ns
t _{SEN_CYCLE}	Minimum Separation Between $\overline{SENABLE}$ rising edge and next $\overline{SENABLE}$ falling edge. (see Figure 35).	If $\overline{SENABLE}$ is taken low less than 3 μ s after it was taken high, there is a small possibility that an offset correction will not be initiated.	3			μ s

NOTES:

- Compliance to datasheet limits is assured by one or more methods: production test, characterization and/or design.
- The limits for the "Nominal Delay Increment" are derived by taking the limits for the "Maximum Delay" and dividing by the number of steps for the device. For the ISL59920, ISL59921, and ISL59922 the number of steps is 31; for the ISL59923 the number of steps is 15.
- All supply currents measured with Delay R = 0ns, G = mid delay, B = full delay.
- Offset measurements are referred to 75 Ω load as shown in Figure 2.

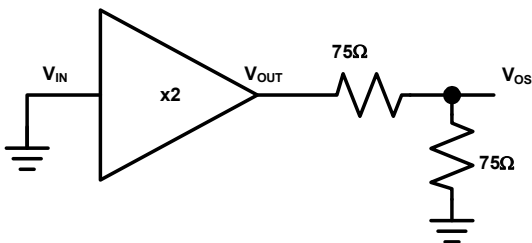

FIGURE 2. V_{0S} MEASUREMENT CONDITIONS

Typical Performance Curves

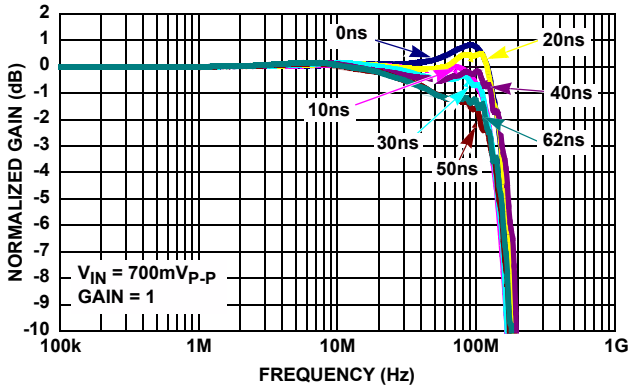

FIGURE 3. ISL59920 FREQUENCY RESPONSE (GAIN = 1)

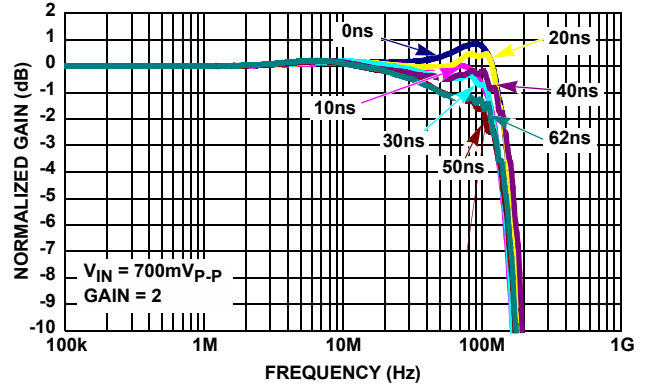

FIGURE 4. ISL59920 FREQUENCY RESPONSE (GAIN = 2)

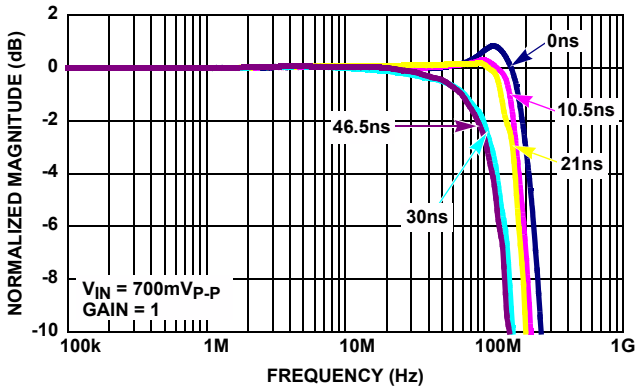

FIGURE 5. ISL59921 FREQUENCY RESPONSE (GAIN = 1)

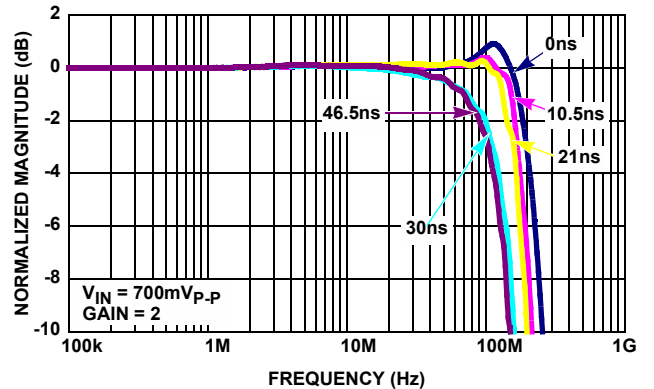

FIGURE 6. ISL59921 FREQUENCY RESPONSE (GAIN = 2)

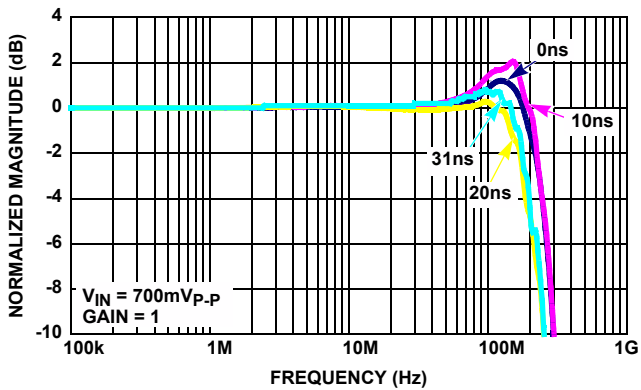

FIGURE 7. ISL59922 FREQUENCY RESPONSE (GAIN = 1)

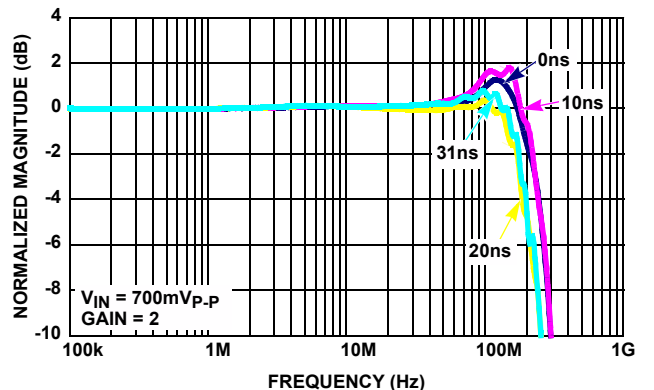

FIGURE 8. ISL59922 FREQUENCY RESPONSE (GAIN = 2)

Typical Performance Curves (Continued)

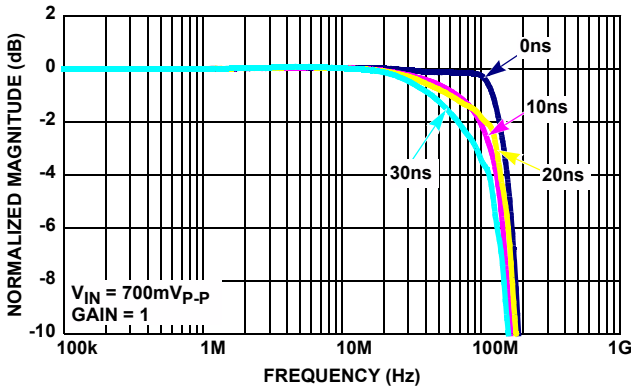

FIGURE 9. ISL59923 FREQUENCY RESPONSE (GAIN = 1)

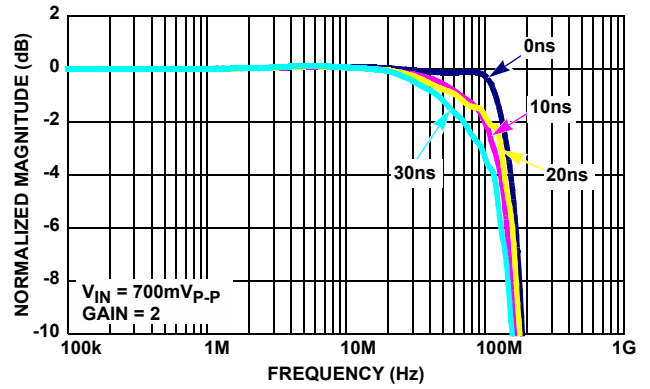

FIGURE 10. ISL59923 FREQUENCY RESPONSE (GAIN = 2)

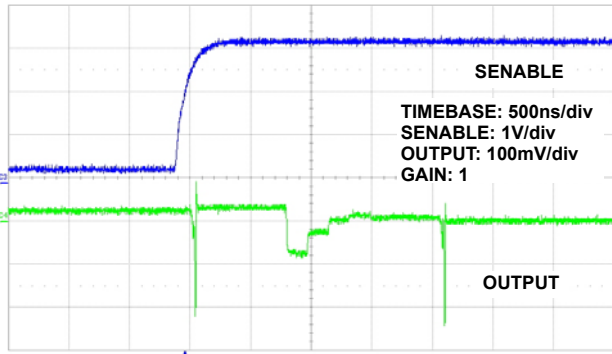

FIGURE 11. OFFSET CORRECTION DAC ADJUST

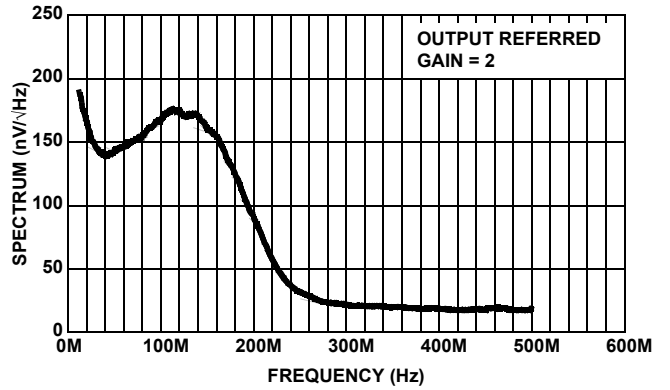

FIGURE 12. ISL59920 NOISE SPECTRUM (10k TO 500MHz)

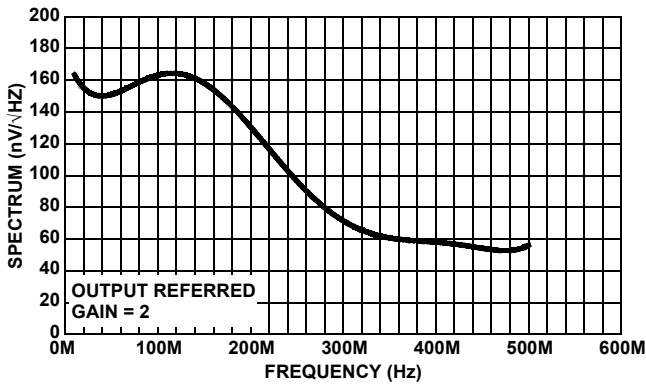

FIGURE 13. ISL59921 NOISE SPECTRUM (10k TO 500MHz)

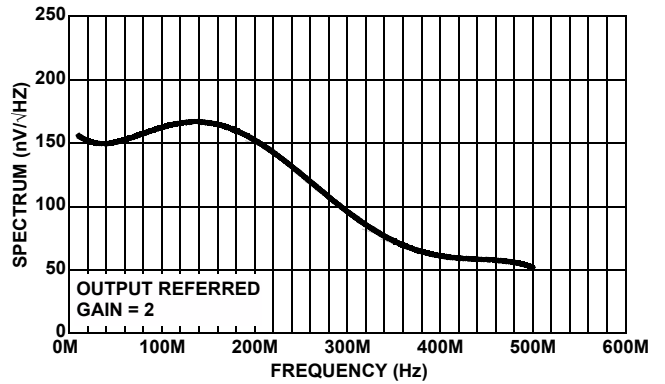

FIGURE 14. ISL59922 NOISE SPECTRUM (10k TO 500MHz)

Typical Performance Curves (Continued)

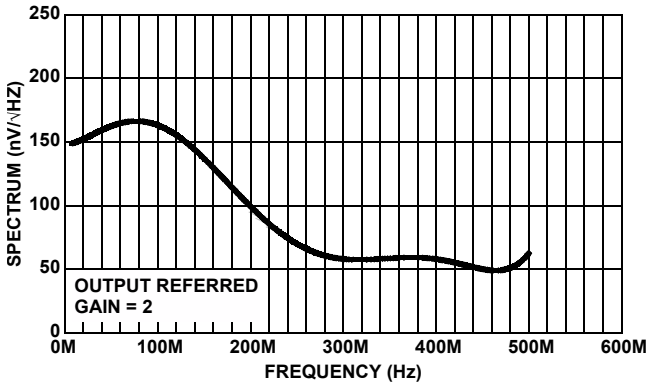

FIGURE 15. ISL59923 NOISE SPECTRUM (10k TO 500MHz)

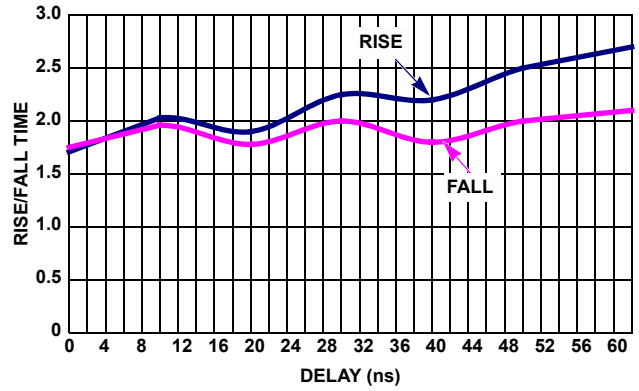

FIGURE 16. ISL59920 RISE/FALL TIME vs DELAY TIME (GAIN = 2)

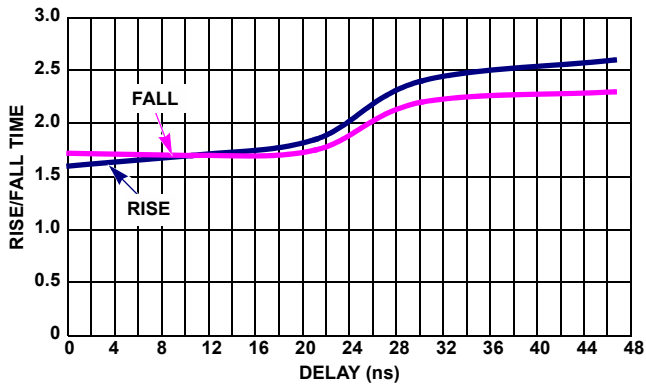

FIGURE 17. ISL59921 RISE/FALL TIME vs DELAY TIME (GAIN = 2)

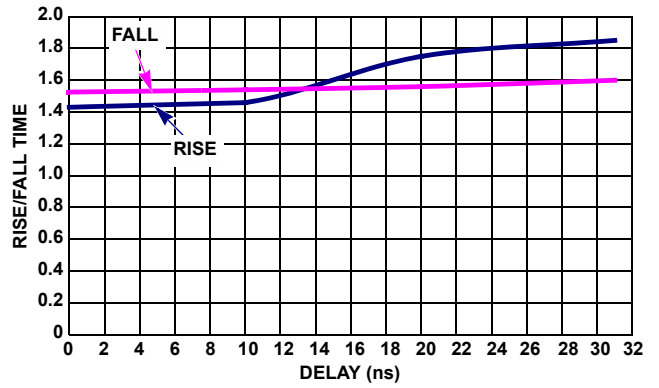

FIGURE 18. ISL59922 RISE/FALL TIME vs DELAY TIME (GAIN = 2)

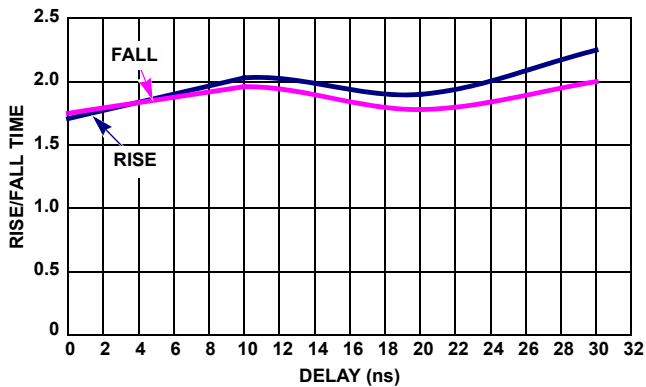

FIGURE 19. ISL59923 RISE/FALL TIME vs DELAY TIME (GAIN = 2)

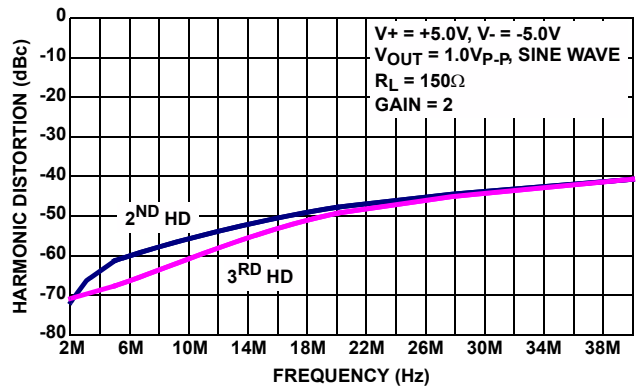

FIGURE 20. HARMONIC DISTORTION vs FREQUENCY

Typical Performance Curves (Continued)

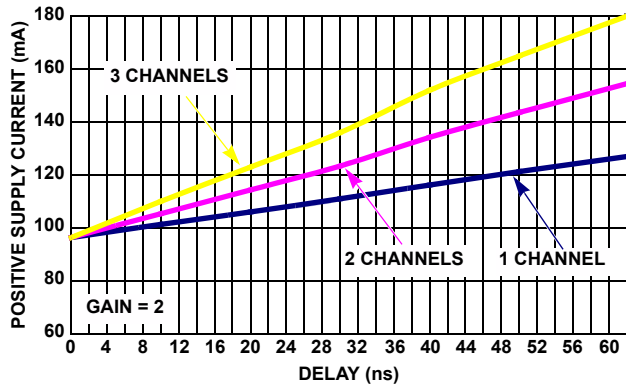

FIGURE 21. ISL59920 POSITIVE SUPPLY CURRENT (V_{SP}) vs DELAY TIME

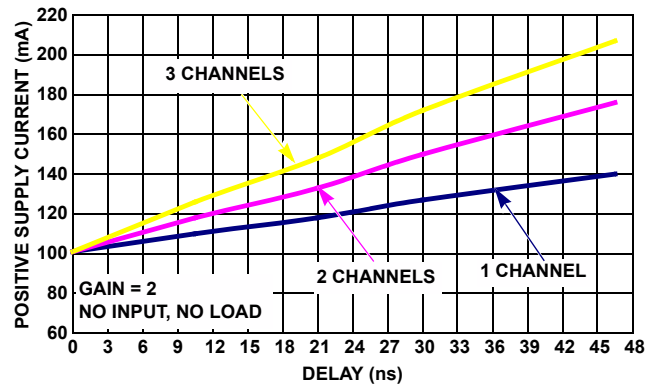

FIGURE 22. ISL59921 POSITIVE SUPPLY CURRENT (V_{SP}) vs DELAY TIME

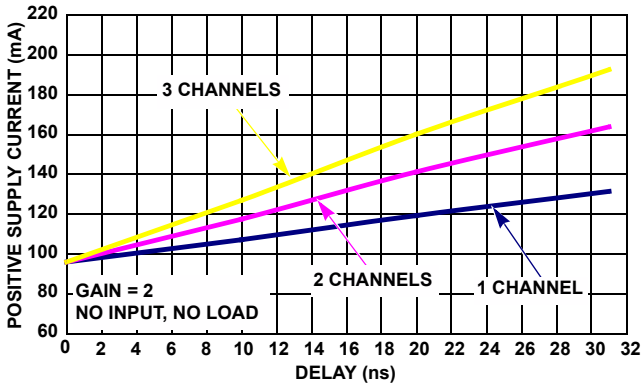

FIGURE 23. ISL59922 POSITIVE SUPPLY CURRENT (V_{SP}) vs DELAY TIME

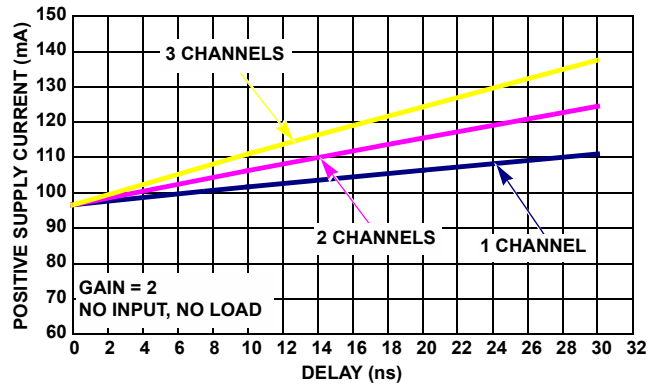

FIGURE 24. ISL59923 POSITIVE SUPPLY CURRENT (V_{SP}) vs DELAY TIME

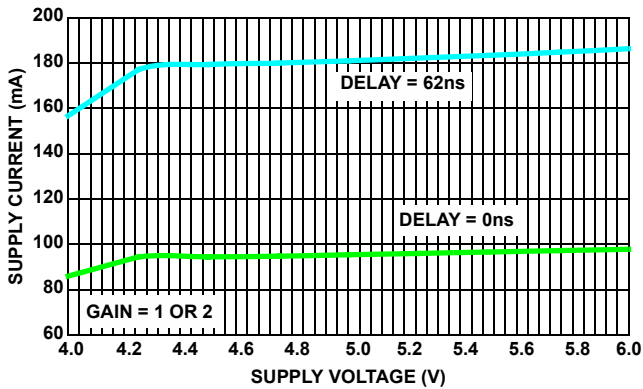

FIGURE 25. ISL59920 $I_{SUPPLY+}$ vs $V_{SUPPLY+}$

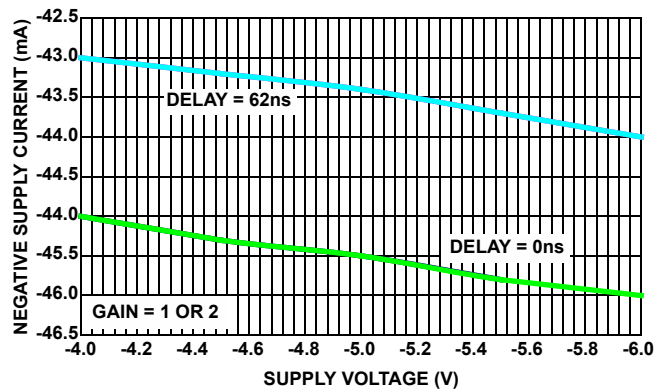

FIGURE 26. ISL59920 $I_{SUPPLY-}$ vs $V_{SUPPLY-}$

Typical Performance Curves (Continued)

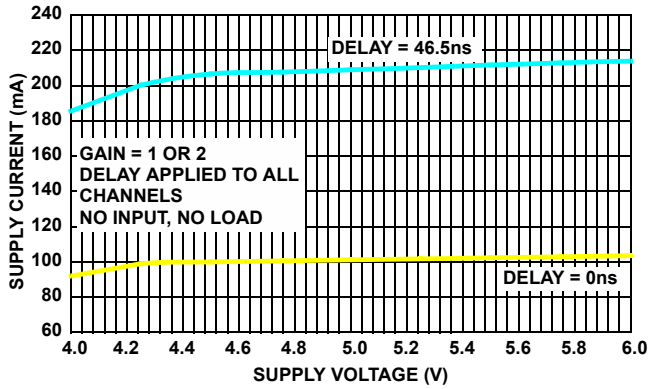

FIGURE 27. ISL59921 $I_{SUPPLY+}$ vs $V_{SUPPLY+}$

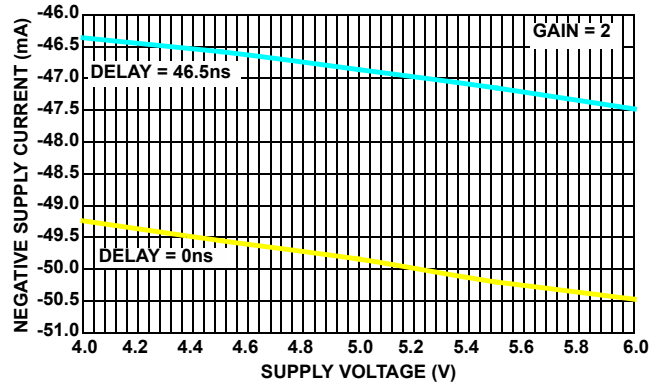

FIGURE 28. ISL59921 $I_{SUPPLY-}$ vs $V_{SUPPLY-}$

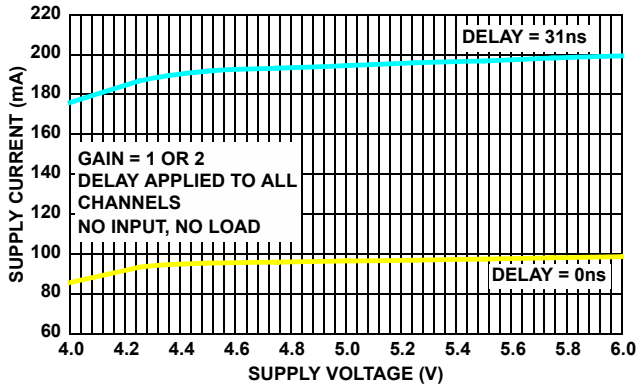

FIGURE 29. ISL59922 $I_{SUPPLY+}$ vs $V_{SUPPLY+}$

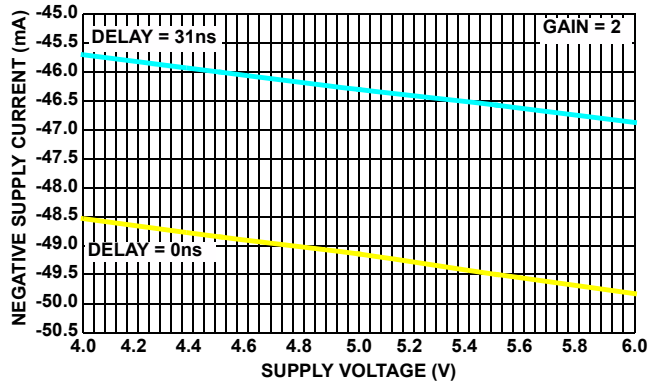

FIGURE 30. ISL59922 $I_{SUPPLY-}$ vs $V_{SUPPLY-}$

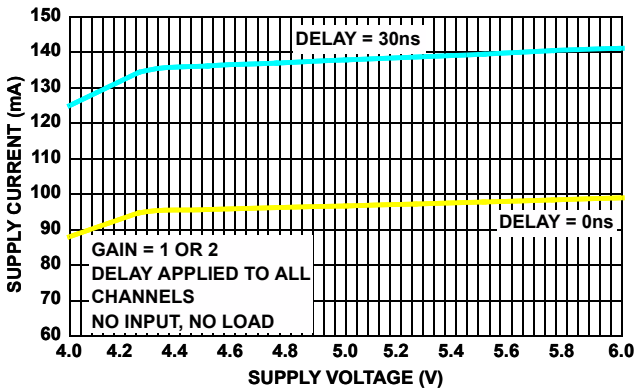

FIGURE 31. ISL59923 $I_{SUPPLY+}$ vs $V_{SUPPLY+}$

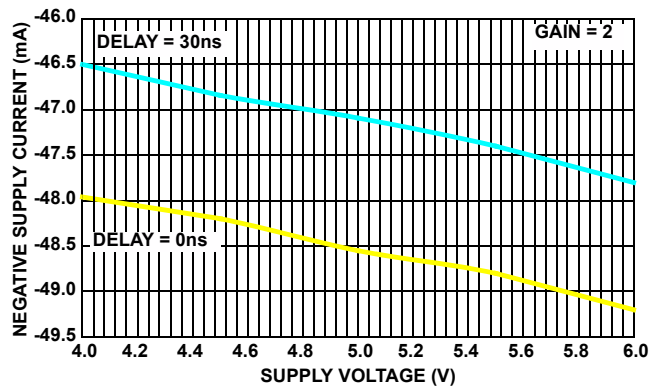

FIGURE 32. ISL59923 $I_{SUPPLY-}$ vs $V_{SUPPLY-}$

Typical Performance Curves (Continued)

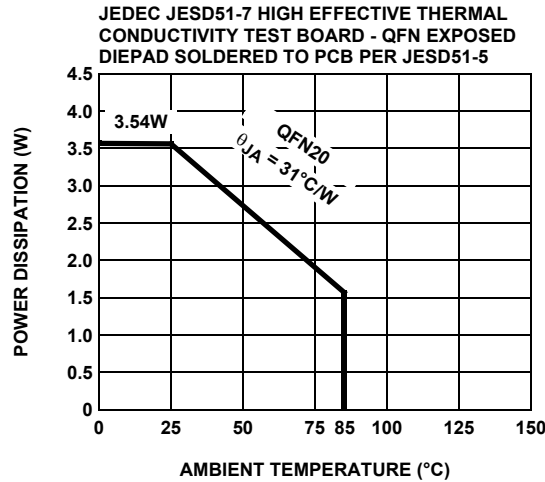

FIGURE 33. PACKAGE POWER DISSIPATION vs AMBIENT TEMPERATURE

Applications Information

The ISL59920, ISL59921, ISL59922, and ISL59923 are triple analog delay lines that provide skew compensation between three high-speed signals. These devices compensate for time skew introduced by a typical CAT-5, CAT-6 or CAT-7 cable with differing electrical lengths (due to different twist ratios) on each pair. Via their SPI interface, these devices can be programmed to independently compensate for the three different cable delays while maintaining 80MHz bandwidth at their maximum setting. There are four different variations of the ISL5992x (ISL5992x will be used when talking about characteristics that are common to all four devices).

TABLE 1. ISL5992x DELAY VARIATIONS

PART NUMBER	MAX DELAY (ns)	NOMINAL DELAY INCREMENT (ns)
ISL59920	62	2.0
ISL59921	46.5	1.5
ISL59922	31	1.0
ISL59923	30	2.0

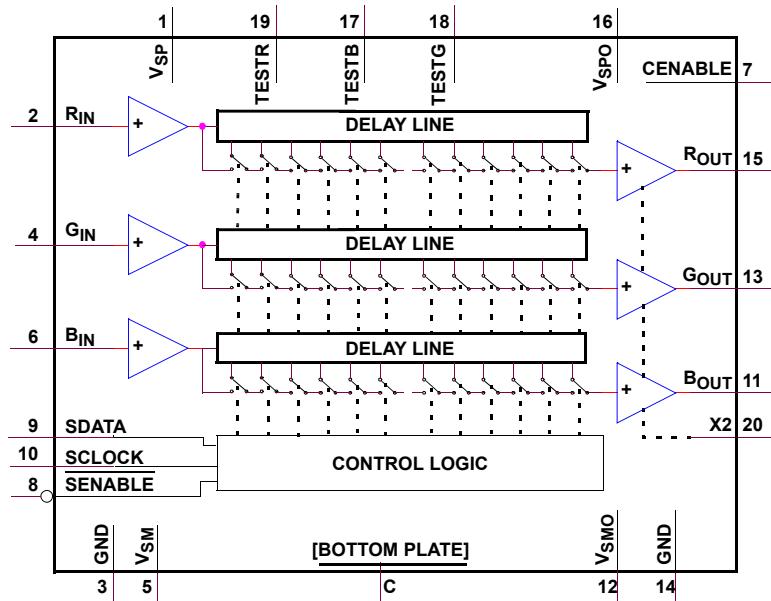

FIGURE 34. ISL59920, ISL59921, ISL59922, ISL59923 BLOCK DIAGRAM

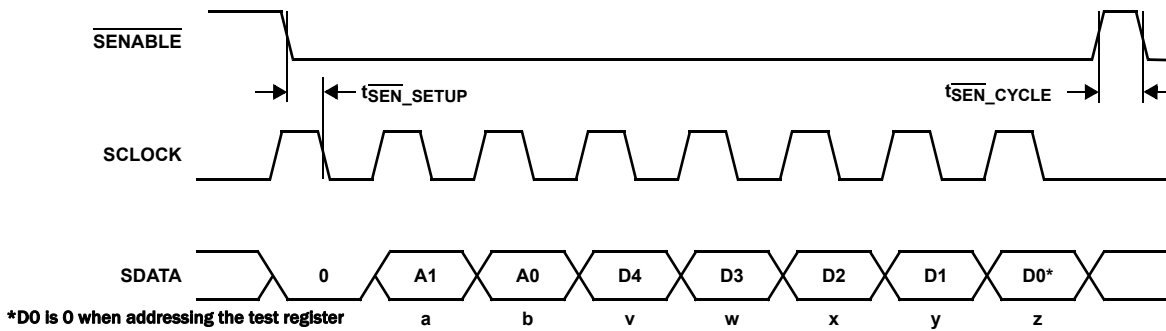

FIGURE 35. SERIAL TIMING

Figure 34 on page 12 shows the ISL5992x block diagram. The 3 analog inputs are ground referenced single-ended signals. After the signal is received, the delay is introduced by switching filter blocks into the signal path. Each filter block is an all-pass filter introducing either 1, 1.5 or 2ns of delay. In addition to adding delay, each filter block also introduces some low pass filtering. As a result, the bandwidth of the signal path decreases from the 0ns delay setting to the maximum delay setting, as shown in Figures 3 through 10 of the “Typical Performance Curves”.

In operation, it is best to allocate the most delayed signal 0ns delay then increase the delay on the other channels to bring them into line. This will result in delay compensation with the lowest power and distortion.

Serial Bus Operation

The ISL5992x is programmed via 8-bit words sent through its serial interface. The first bit (MSB) of SDATA is latched on the first falling clock edge after SENABLE goes low, as shown in Figure 35. This bit should be a 0 under all conditions. The next two bits determine the color register to be written to: 01 = R, 02 = G, and 03 = B (00 is reserved for the test register). The final five bits set the delay for the specified color. After 8 bits are latched, any additional clocks are treated as a new word (data is shifted directly to the final registers as it is clocked in). This allows the user to write (for example) the 24 bits of data necessary for R, G, and B as a single 24-bit word. It is the user's responsibility to send complete multiples of 8 clock cycles. The serial state machine is reset on the falling edge of SENABLE, so any data corruption that may have occurred due to too many or too few clocks can be corrected with a new word with the correct number of clocks. The initial value of all registers on power-up is 0.

TABLE 2. SERIAL BUS DATA

vwxyz	ISL59920 DELAY	ISL59921 DELAY	ISL59922 DELAY	ISL59923 DELAY
00000	0	0	0	0
00001	2	1.5	1	2
00010	4	3	2	4
00011	6	4.5	3	6
00100	8	6	4	8
00101	10	7.5	5	10

TABLE 2. SERIAL BUS DATA (Continued)

vwxyz	ISL59920 DELAY	ISL59921 DELAY	ISL59922 DELAY	ISL59923 DELAY
00110	12	9	6	12
00111	14	10.5	7	14
01000	16	12	8	16
01001	18	13.5	9	18
01010	20	15	10	20
01011	22	16.5	11	22
01100	24	18	12	24
01101	26	19.5	13	26
01110	28	21	14	28
01111	30	22.5	15	30
10000	32	24	16	N/A
10001	34	25.5	17	N/A
10010	36	27	18	N/A
10011	38	28.5	19	N/A
10100	40	30	20	N/A
10101	42	31.5	21	N/A
10110	44	33	22	N/A
10111	46	34.5	23	N/A
11000	48	36	24	N/A
11001	50	37.5	25	N/A
11010	52	39	26	N/A
11011	54	40.5	27	N/A
11100	56	42	28	N/A
11101	58	43.5	29	N/A
11110	60	45	30	N/A
11111	62	46.5	31	N/A

NOTE: Delay register word = 0abvwxyz; Red register - ab = 01; Green register - ab = 10; Blue register - ab = 11; vwxyz selects delay; ab = 00 writes to the test register to change the DAC slice level.

Offset Compensation

To counter the effects of offset, the ISL5992x incorporates an offset compensation circuit that reduces the offset to less than $\pm 25\text{mV}$. An offset correction cycle is triggered by the rising edge of the $\overline{\text{SENABLE}}$ pin after writing a delay word to any of the 3 channels. The offset calibration starts about 500ns after the $\overline{\text{SENABLE}}$ rising edge to allow the ISL5992x time to settle (electrically and thermally) to the new delay setting. It lasts about $2.5\mu\text{s}$, for a total offset correction time of $3.0\mu\text{s}$. During calibration, the ISL5992x's inputs are internally shorted together (however the characteristics of the ISL5992x's differential input pins stay the same), and the offset of the output stage is adjusted until it has been minimized.

In addition to automatically triggering after a delay change (or any register write), an additional offset calibration may be initiated at any time, such as:

- When the die temperature changes. Applying power to the ISL5992x will cause the die temperature to quickly increase then slowly settle over 20 to 30ns. Because the ISL5992x powers-down unused delay stages (to minimize power consumption), the die temp will also change and settle after a delay change. Initiating an offset 20ns (or longer, depending on the thermal characteristics of the system) after power-on or a delay change will minimize the offset in normal operation thereafter.
- When the ambient temperature changes. If you are monitoring the temperature, initiate a calibration every time the temperature shifts by 5 to 10 degrees. If you are not monitoring temperature, initiate a calibration periodically, as expected by the environment the device is in.
- After a $\overline{\text{CENABLE}}$ (Chip Enable) cycle. The $\overline{\text{CENABLE}}$ pin may be taken low to put the ISL5992x in a low power standby mode to conserve power when not needed. When the $\overline{\text{CENABLE}}$ pin goes high to exit this low power mode, the ISL5992x will recall the delay settings but it will *not* recall the correct offset calibration settings, so to maintain low offset, a write to the delay register is required after a $\overline{\text{CENABLE}}$ cycle. Offset errors may be as large as $\pm 200\text{mV}$ coming out of standby mode - **recalibration is a necessity**. For best performance, initiate an additional calibration again once the die temperature has settled (20 to 30ns after coming out of standby).
- After a gain change (X2 pin changes state). The systematic offset is different for a gain of x1 vs. a gain of x2, so an offset calibration is recommended after a gain change. However in a typical application the gain is permanently fixed at x1 or x2, so this is not usually a concern.

Offset Calibration with Sync-On-Video

The offset correction mechanism temporarily disconnects the input signals to perform the offset calibration. This introduces several discontinuities in the video signal, as shown in [Figure 11](#) on [page 8](#):

- 200mV to 300mV spike when calibration is engaged
- Successive approximation offset null
- 200mV to 300mV spike when calibration is disengaged
- In addition, because an offset calibration is performed any time the delay changes, the output video signal may be moved forward or back in time by up to 62ns.

If the video signals going through the ISL5992x contain only video (with no sync signals), this appears as a $2\mu\text{s}$ "sparkle" on the screen - usually it is not even visible to the eye.

However if sync signals are embedded on the video, the spikes may be misinterpreted as a sync signal, causing the downstream circuitry to see an asynchronous sync pulse. In some receiving systems (typically monitors), a single asynchronous sync pulse can cause the system to think the video signal has changed. Depending on the receiving monitor's design, this can initiate a new video acquisition cycle (for example, the monitor blanks the screen while it measures the "new" HSYNC and VSYNC timing, selects the right mode, and optimizes the image). This can cause the monitor to go blank for up to several seconds after a single delay change.

Since this only happens at power-on and when the delays are initially set, this is not a problem in normal use, but if the monitor is blanking for several seconds every time the delay is adjusted, it can cause calibration to take longer than absolutely necessary. If this behavior is undesirable, it can be eliminated as follows:

1. Synchronize the rising edge of $\overline{\text{SENABLE}}$ to the sync pulse, so that the $\overline{\text{SENABLE}}$ goes high immediately after the trailing edge of the sync pulse. $\overline{\text{SENABLE}}$ can be taken low and the serial data written asynchronously at any time - it is the *rising* edge of $\overline{\text{SENABLE}}$ that triggers a calibration.
2. If the Sync Processor is part of the same design as ISL5992x, ensure that the sync processor ignores the first x microseconds after a valid sync, where $x = 3\mu\text{s} +$ the delay between the end of a sync and rising edge of $\overline{\text{SENABLE}}$. This will prevent the sync processor from generating invalid sync signals due to the spikes.
3. If the Sync Processor is external to the design with the ISL5992x (video with Sync-On-Green, for example), the video signal should be disconnected from the ISL59920 and shorted to ground via an analog switch for the first x microseconds after a valid sync, where $x = 3\mu\text{s} +$ the delay between the end of a sync and rising edge of $\overline{\text{SENABLE}}$. This will remove the calibration signals from the video signal.

These steps are only necessary if the sync signal is embedded on the video.

Note: Avoid possible monitor blanking during skew adjustment.

Test Pins

Three test pins are provided (Test R, Test G, Test B). During normal operation, the test pins output pulses of current for a duration of the overlap between the inputs, as shown in [Figure 36](#):

$TEST_R$ pulse = RED_{OUT} (A) with respect to $GREEN_{OUT}$ (B)

$TEST_G$ pulse = $GREEN_{OUT}$ with respect to $BLUE_{OUT}$

$TEST_B$ pulse = $BLUE_{OUT}$ with respect to RED_{OUT}

Averaging the current gives a direct measure of the delay between the two edges. When A precedes B, the current pulse is $+50\mu A$, and the output voltage goes up. When B precedes A, the pulse is $-50\mu A$.

For the logic to work correctly, A and B must have a period of overlap while they are high (a delay longer than the pulse width cannot be measured).

Signals A and B are derived from the video input by comparing the video signal with a slicing level, which is set by an internal DAC. This enables the delay to be measured either from the rising edges of sync-like signals encoded on top of the video or from a dedicated set-up signal. The outputs can be used to set the correct delays for the signals received.

The DAC level is set through the serial input by bits 1 through 4 directed to the test register (00).

Internal DAC Voltage

The slice level of the internal DAC may be programmed by writing a byte to the test register (00). [Table 3](#) shows the values that should be written to change the DAC slice level. Please keep in mind when writing to the test register that the LSB should always be zero.

Referred to the input, the DAC slice range for the ISL5992x is cut in half for gain of 2 mode because the slicing occurs after the $x1/x2$ stage output amplifier. (In the EL9115, the slicing occurred before the amplifier so the range of the DAC voltage was the same for either gain of 1 or gain of 2).

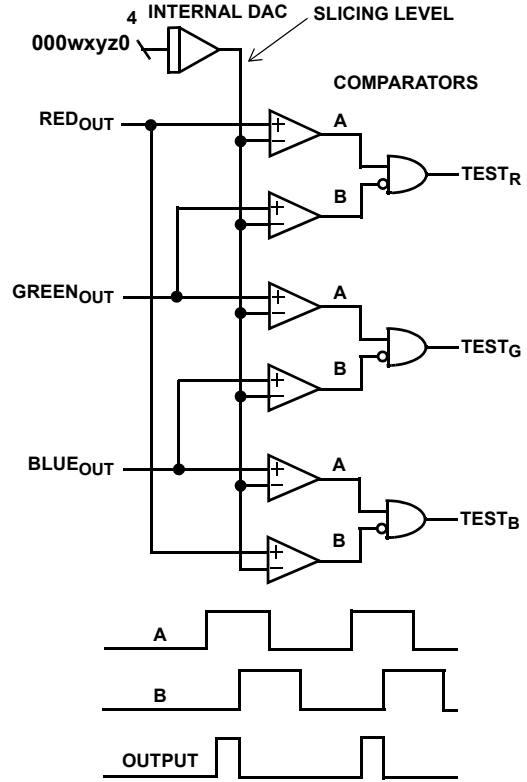

FIGURE 36. DELAY DETECTOR

TABLE 3. DAC VOLTAGE RANGE - INPUT REFERRED

wxyz	DAC RANGE [mV] (GAIN 1)	DAC RANGE [mV] (GAIN 2)
1000	-400	-200
1001	-350	-175
1010	-300	-150
1011	-250	-125
1100	-200	-100
1101	-150	-75
1110	-100	-50
1111	-50	-25
0000	0	0
0001	50	25
0010	100	50
0011	150	75
0100	200	100
0101	250	125
0110	300	150
0111	350	175

NOTE: Test Register word = 000wxyz0. wxyz fed to DAC. z is LSB

CENABLE at Power-On

To guarantee proper operation, the CENABLE pin should be held low for at least 30ms after the power supply has settled to within 5% of its final value.

If CENABLE cannot be guaranteed to be held low during this time, an RC delay can be inserted between the CENABLE source and the CENABLE input to meet this requirement as shown in [Figure 37](#). R_1 and C_1 generate an ~33ms delay, and D_1 discharges any charge on C_1 when the power to the ISL5992x is removed.

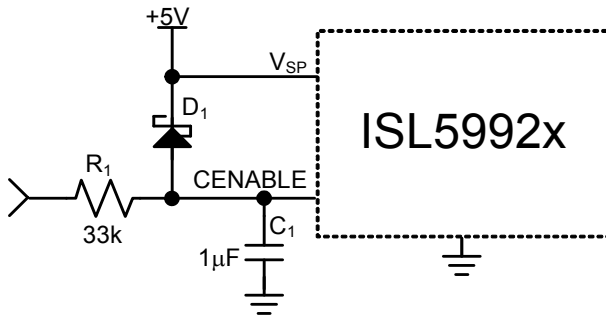

FIGURE 37. CENABLE RC DELAY

Power Dissipation

As the delay setting increases, additional filter blocks turn on and insert into the signal path. When the delay per channel increments, V_{SP} current increases by 0.9mA while V_{SM} does not change significantly. Under the extreme settings, the positive supply current reaches 141mA and the negative supply current can be 41mA. Operating at $\pm 5V$ power supply, the worst-case ISL5992x power dissipation is shown by [Equation 1](#):

$$PD = 5 \cdot 141\text{mA} + 5 \cdot 41\text{mA} = 910\text{mW} \quad (\text{EQ. 1})$$

The minimum θ_{JA} required for long term reliable operation of the ISL5992x is calculated using [Equation 2](#):

$$\theta_{JA} = (T_J - T_A) / PD = 55^\circ\text{C}/\text{W} \quad (\text{EQ. 2})$$

Where:

T_J is the maximum junction temperature (+135°C)

T_A is the maximum ambient temperature (+85°C)

For a 20 Ld package on a well laid-out PCB with good connectivity between the QFN's pad and the PCB copper area, 31°C/W θ_{JA} thermal resistance can be achieved. This yields a much higher power dissipation of 3.54W using [Equation 2](#) (see [Figure 33](#)). To disperse the heat, the bottom heat spreader must be soldered to the PCB. Heat flows through the heat spreader to the circuit board copper then spreads and convects to air. Thus, the PCB copper plane becomes the heatsink (see [TB389](#)). This has proven to be a very effective technique. A separate application note, which details the 20 Ld QFN PCB design considerations, is available.

Revision History

The revision history provided is for informational purposes only and is believed to be accurate, but not warranted. Please go to the web to make sure that you have the latest revision.

DATE	REVISION	CHANGE
August 27, 2015	FN6826.4	Updated Ordering Information table on page 2.
September 25, 2014	FN6826.3	Added Revision History. Converted to new datasheet template. Added note on CENABLE delay to CENABLE entry in Pin Descriptions table on page 2. Added "CENABLE at Power-On" on page 16.

About Intersil

Intersil Corporation is a leading provider of innovative power management and precision analog solutions. The company's products address some of the largest markets within the industrial and infrastructure, mobile computing and high-end consumer markets.

For the most updated datasheet, application notes, related documentation and related parts, please see the respective product information page found at www.intersil.com.

You may report errors or suggestions for improving this datasheet by visiting www.intersil.com/ask.

Reliability reports are also available from our website at www.intersil.com/support

© Copyright Intersil Americas LLC 2008-2015. All Rights Reserved.
All trademarks and registered trademarks are the property of their respective owners.

For additional products, see www.intersil.com/en/products.html

Intersil products are manufactured, assembled and tested utilizing ISO9001 quality systems as noted in the quality certifications found at www.intersil.com/en/support/qualandreliability.html

Intersil products are sold by description only. Intersil may modify the circuit design and/or specifications of products at any time without notice, provided that such modification does not, in Intersil's sole judgment, affect the form, fit or function of the product. Accordingly, the reader is cautioned to verify that datasheets are current before placing orders. Information furnished by Intersil is believed to be accurate and reliable. However, no responsibility is assumed by Intersil or its subsidiaries for its use; nor for any infringements of patents or other rights of third parties which may result from its use. No license is granted by implication or otherwise under any patent or patent rights of Intersil or its subsidiaries.

For information regarding Intersil Corporation and its products, see www.intersil.com

Quad Flat No-Lead Plastic Package (QFN)

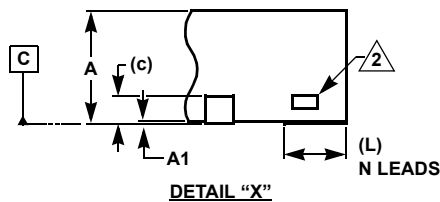
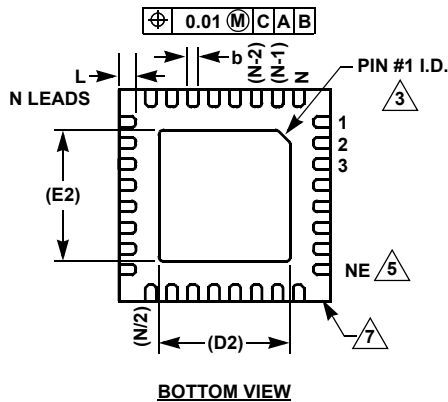
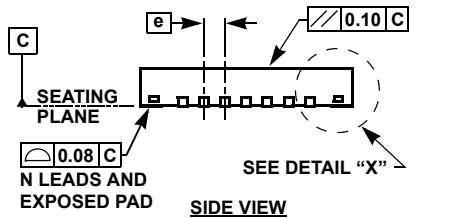
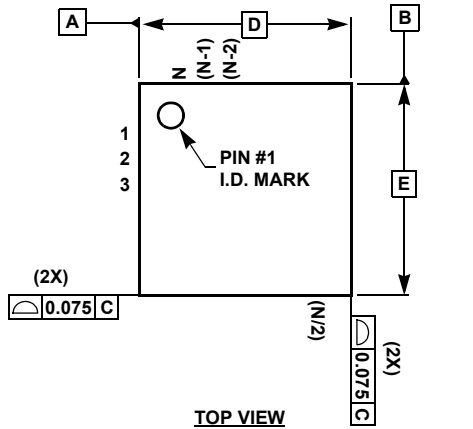

L20.5x5C

20 LEAD QUAD FLAT NO-LEAD PLASTIC PACKAGE
(COMPLIANT TO JEDEC MO-220)

SYMBOL	MILLIMETERS			NOTES
	MIN	NOMINAL	MAX	
A	0.80	0.90	1.00	-
A1	0.00	0.02	0.05	-
b	0.28	0.30	0.32	-
c	0.20 REF			-
D	5.00 BASIC			-
D2	3.70 REF			8
E	5.00 BASIC			-
E2	3.70 REF			8
e	0.65 BASIC			-
L	0.35	0.40	0.45	-
N	20			4
ND	5 REF			6
NE	5 REF			5

Rev. 0 6/06

NOTES:

1. Dimensioning and tolerancing per ASME Y14.5M-1994.
2. Tiebar view shown is a non-functional feature.
3. Bottom-side pin #1 I.D. is a diepad chamfer as shown.
4. N is the total number of terminals on the device.
5. NE is the number of terminals on the "E" side of the package (or Y-direction).
6. ND is the number of terminals on the "D" side of the package (or X-direction). $ND = (N/2) - NE$.
7. Inward end of terminal may be square or circular in shape with radius $(b/2)$ as shown.
8. If two values are listed, multiple exposed pad options are available. Refer to device-specific datasheet.
9. One of 10 packages in MDP0046

Looking for pricing, stock, or lifecycle information?

Click below to explore more details on WIN SOURCE:

 [View ISL59920IRZ-T7 on WIN SOURCE](#)

 [Intersil Information](#)

Optimize Your Supply Chain with WIN SOURCE Solutions

-  Global Sourcing Solution
-  Obsolete Management
-  Cost Control Management
-  Shortage Management
-  Alternative Solution
-  Excess Inventory Management