



# Chip varistors

Voltage Protection Devices

Automotive grade

# AVR series

---

## AVRM, AVR-M series

AVRM1608/AVR-M1608 JIS 1608 [EIA 0603]

AVRM2012/AVR-M2012 JIS 2012 [EIA 0805]

## AVRL series

AVRL10 JIS 1005 [EIA 0402]

AVRL16 JIS 1608 [EIA 0603]

## AVRH series

AVRH10 JIS 1005 [EIA 0402]

AVRH16A2 JIS 1608 [EIA 0603]

---

## REMINDERS FOR USING THESE PRODUCTS

Before using these products, be sure to request the delivery specifications.

### SAFETY REMINDERS

Please pay sufficient attention to the warnings for safe designing when using this products

### REMINDERS

- Please pay careful attention to the precautions and follow safe designing practices when using these products.
- Please observe the following precautions in order to avoid problems with chip varistors such as characteristic degradation and element destruction
  - Please store these products in an environment with a temperature of 5 to 40°C and humidity level of 20 to 70%RH, and use them within six months.
  - Poor storage conditions may lead to the deterioration of the solderability of the edge electrodes, so please be careful to avoid contact with humidity, dew condensation, dust, toxic gas (hydrogen, hydrogen sulfide, sulfurous acid, chlorine, ammonia, etc.), direct sunlight, and so on.
  - Please do not use products that have been dropped or detached when mounting.
  - Please solder with the reflow soldering method, and not the flow (dip) soldering method.
- Please observe the following precautions to avoid problems with varistors such as characteristic degradation and element destruction, which ultimately lead to the generation of heat and smoke with the elements.
  - Do not use in locations where the temperatures exceed the operating temperature range such as under direct sunlight or near sources of heat.
  - Do not use in locations where there are high levels of humidity such as under direct exposure to weather and areas where steam is released.
  - Do not use in locations such as dusty areas, high-saline environments, places where the atmosphere is contaminated with corrosive gas, etc.
  - Avoid powerful vibrations, impact (such as by dropping), pressure, etc. that may lead to splitting in the products.
  - Do not use with a voltage that exceeds the maximum allowable circuit voltage.**
  - When resin coating (including modular) a varistor, do not use a resin that will cause deterioration of the varistor. Be sure never to use resin that generates hydrogen as palladium is used for the inner electrode.
  - Avoid attachment near combustible materials.
- Please contact our sales offices when considering the use of the products listed on this catalog for applications, whose performance and/or quality require a more stringent level of safety or reliability, or whose failure, malfunction or trouble could cause serious damage to society, person or property (specific uses such as automobiles, airplanes, medical instruments, nuclear devices, etc.) as well as when considering the use for applications that exceed the range and conditions of this catalog.
- As range of catalog, conditions are transcended, or for damage that generated by was used in application specific, etc, accept no the responsibility, wish.
- Please take appropriate measures such as acquiring protective circuits and devices that meet the uses, applications, and conditions of the instruments and keeping backup circuits.

# Chip varistors

## Automotive grade

RoHS Directive Compliant Product  
Compatible with lead-free solders  
AEC-Q200

# Overview of the AVR series

### CHARACTERISTICS OF CHIP VARISTOR

Varistors are voltage dependent nonlinear resistive elements with a resistance that decreases rapidly when the voltage is over the constant value.  
Varistors become zener diode of 2 serial connection and equivalent, and does not have polarity.

#### current vs. voltage characteristics

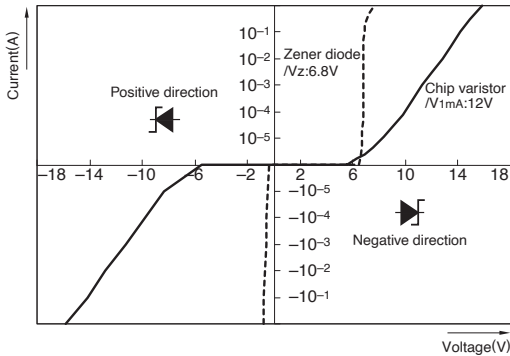

#### the effect of the varistor

##### Without varistor

A malfunction and failure of electronic equipment

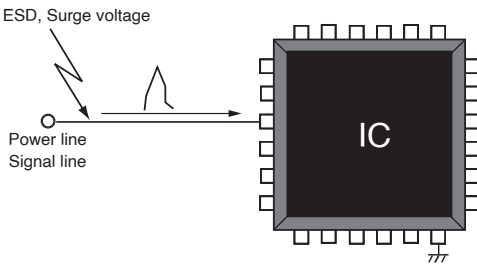

##### With Varistor

Suppress transient voltage by inserting varistor in a circuit

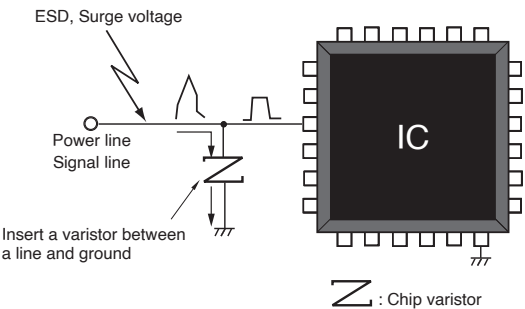

### EQUIVALENT CIRCUIT OF CHIP VARISTORS

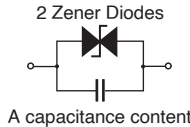

### CHIP VARISTORS FEATURE

- IEC61000-4-2 compliant
- Reliability characteristics evaluated based on AEC-Q200 condition.
- High ESD withstanding voltage
- Small-sized products are available
- 125°C, 150°C Supported

Figure 1 internal structure of multilayer chip varistors

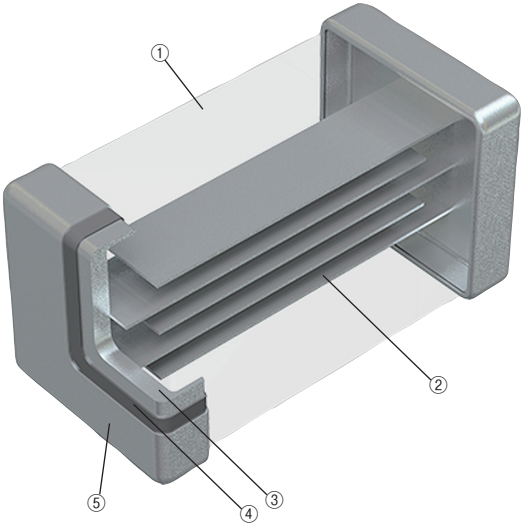

No.	Name
(1)	Semiconductor ceramics
(2)	Internal electrode (Pd)
(3)	Ag
(4)	Terminal electrode Ni
(5)	Sn

Please be sure to request delivery specifications that provide further details on the features and specifications of the products for proper and safe use. Please note that the contents may change without any prior notice due to reasons such as upgrading.

Chip varistors  
Automotive grade

RoHS Directive Compliant Product  
Compatible with lead-free solders  
AEC-Q200

# Overview of the AVR series

**COMMUNICATION STANDARD, CIRCUIT EXAMPLE AND COMMUNICATION STANDARD**

		LIN/CXPI	Classical CAN	CAN/CAN-FD
Type	Dimensions code JIS [EIA]			
		20 kbps	1 Mbps	2-8 Mbps
Chip varistors	1005 [0402]	<a href="#">AVRH10C220YT201MA8</a>	<a href="#">AVRH10C270KT350NA8</a>	<a href="#">AVRH10C270KT150NA8</a>
	1608 [0603]	<a href="#">AVRM1608C270KT221M</a>	<a href="#">AVR-M1608C270MTAAB</a>	<a href="#">AVR-M1608C270MTABB</a>
	1608 [0603] 2 in 1 Array	N/A	<a href="#">AVRH16A2C270KT200NA8</a>	<a href="#">AVRH16A2C270KT200NA8</a>
	2012 [0805]	N/A	N/A	N/A

		FlexRay	MOST50	USB2.0
Type	Dimensions code JIS [EIA]			
		10 Mbps	50 Mbps	480 Mbps
Chip varistors	1005 [0402]	<a href="#">AVRH10C270KT150NA8</a>	<a href="#">AVRH10C270KT150NA8</a>	<a href="#">AVRL101D3R3FTA</a>
	1608 [0603]	<a href="#">AVR-M1608C270MTABB</a>	<a href="#">AVR-M1608C270MTABB</a>	<a href="#">AVRL161D3R3FTA</a>
	2012 [0805]	N/A	N/A	N/A

		One-Pair Ethernet 100BASE-T1	One-Pair Ethernet 1000BASE-T1	Motors
Type	Dimensions code JIS [EIA]			
		100Mbps	1000Mbps	-
Chip varistors	1005 [0402]	<a href="#">AVRH10C101KT4R7YA8</a>	<a href="#">AVRH10C101KT1R2YE8</a> <a href="#">AVRH10C221KT1R5YA8</a>	N/A
	1608 [0603]	N/A	N/A	<a href="#">AVR-M1608C270KT6AB</a>
	2012 [0805]	N/A	N/A	<a href="#">AVR-M2012C390KT6AB</a>

⚠ Please be sure to request delivery specifications that provide further details on the features and specifications of the products for proper and safe use. Please note that the contents may change without any prior notice due to reasons such as upgrading.

# Chip varistors

## Automotive grade

RoHS Directive Compliant Product  
Compatible with lead-free solders  
AEC-Q200

# Overview of the AVR series

## PART NUMBER CONSTRUCTION

### AVRM series

AVRM	1608	C	390	K	T	271	N						
Series name	L x W dimensions (mm)		Structure code	Varistor voltage (V)		Varistor voltage tolerance (%)		Packaging style		Capacitance or internal special symbol (pF)		Capacitance tolerance (%)	
AVRM series	1608	1.6x0.8	C   General structure	390=39x10 <sup>0</sup>		K	±10	T	Taping	271=27x10 <sup>1</sup>		K	±10
	2012	2.0x1.2		220	22	M	±20			221	220	M	±20
				270	27	N	±30			271	270	N	±30
				390	39								

### AVR-M series

AVR-M	1608	C	270	M	T	AAB		
Series name	L x W dimensions (mm)		Structure code	Varistor voltage (V)	Varistor voltage tolerance (%)		Packaging style	Company special symbol
AVR-M series	1608	1.6x0.8	C   General structure	270=27x10 <sup>0</sup>	K	±10	T	Taping
	2012	2.0x1.2		220	22	M	±20	
				270	27	N	±30	
				390	39			

### AVRL series

AVRL	10	1D	3R3	F	T	A				
Series name	L x W dimensions (mm)		Maximum continuous voltage (Vdc)		Capacitance (pF)		Capacitance tolerance (pF)		Packaging style	Company special symbol
AVRL series	10	1.0x0.5	1D	20	3R3	3.3	F	±1	T	Taping
L=Low cap	16	1.6x0.8			6R8	6.8	G	±2		

# Chip varistors

## Automotive grade

RoHS Directive Compliant Product  
Compatible with lead-free solders  
AEC-Q200

# Overview of the AVR series

## PART NUMBER CONSTRUCTION

### AVRH series

<b>AVRH</b>	<b>10</b>	<b>C</b>	<b>270</b>	<b>K</b>	<b>T</b>	
<b>Series name</b>	<b>L x W dimensions (mm)</b>		<b>Structure code</b>	<b>Varistor voltage (V)</b>	<b>Varistor voltage tolerance (%)</b>	<b>Packaging style</b>
AVRH series	10	1.0x0.5	C General structure	270=27x10 <sup>0</sup>	K ±10	T Taping
H=High Reliability				270   27	Y   Special	
				390   39		
				101   100		

<b>150</b>	<b>N</b>	<b>A</b>	<b>8</b>
<b>Capacitance (pF)</b>	<b>Capacitance tolerance</b>		<b>ESD voltage tolerance IEC61000-4-2 (kV)</b>
150=15x10 <sup>0</sup>	N	±30%	A 25
150   15	F	±1pF	E 8
500   50	M	±20%	
4R7   4.7	Y	Special	
			8   150

### AVRH series (Array)

<b>AVRH</b>	<b>16</b>	<b>A2</b>	<b>C</b>	<b>270</b>	<b>K</b>	<b>T</b>	
<b>Series name</b>	<b>L x W dimensions (mm)</b>		<b>Type</b>	<b>Structure code</b>	<b>Varistor voltage (V)</b>	<b>Varistor voltage tolerance (%)</b>	<b>Packaging style</b>
AVRH series	16	1.6x0.8	A2 2in1Array	C General structure	270=27x10 <sup>0</sup>	K ±10	T Taping
H=High Reliability					270   27		

<b>200</b>	<b>N</b>	<b>A</b>	<b>8</b>
<b>Capacitance (pF)</b>	<b>Capacitance tolerance</b>		<b>ESD voltage tolerance IEC61000-4-2 (kV)</b>
200=20x10 <sup>0</sup>	N	±30%	A 25
200   20			8   150

# Chip varistors

## Automotive grade

RoHS Directive Compliant Product  
Compatible with lead-free solders  
AEC-Q200

# Overview of the AVR series

## TERMINOLOGY

Item	Unit	Description
Varistor voltage (Breakdown voltage)	V <sub>1mA</sub> (V)	Chip varistor-terminal voltage when DC1mA was flowed
Maximum continuous voltage	V <sub>dc</sub> (V)	DC voltage that is continuously applied between chip varistor terminals Terminal chip varistors leakage current-value: 50μA max Voltage appearing across the varistor when a pulse current (8/20μs*1) of specified peak value is applied.
Clamping voltage	V <sub>cl</sub> (V)	Voltage between terminal chip varistors of the Specified peak current value of the impulse current(8/20μs*1) is applied
Maximum energy	E(Joule)	When applied specified peak impulse current-value current(10/1000μs*2) once, maximum energy that electrical property of chip varistors be not deteriorated
Maximum peak current	I <sub>p</sub> (A)	When applied impulse current(8/20μs*1) once, maximum current that electrical property of chip varistors be not deteriorated
Capacitance	C(pF)	Oscillator frequency 1kHz or 1MHz, Capacitance between chip varistor-terminal in oscillator voltage 1Vrms
Capacitance Difference	ΔC(pF)	Measure the capacitance of each Ch at an oscillator frequency of 1MHz and an oscillator voltage of 1V, The absolute value of the difference of the capacitance values obtained

\*1 8/20μs test waveform

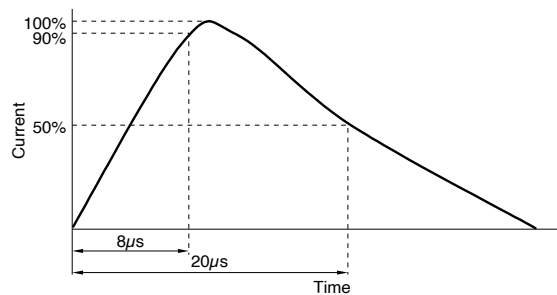

\*2 10/1000μs test waveform

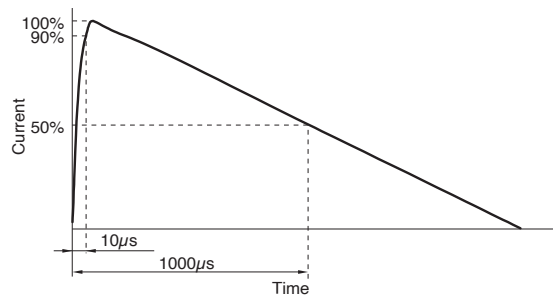

# Chip varistors

## Automotive grade

RoHS Directive Compliant Product  
Compatible with lead-free solders  
AEC-Q200

# AVR series 1005 type

## SHAPE & DIMENSIONS

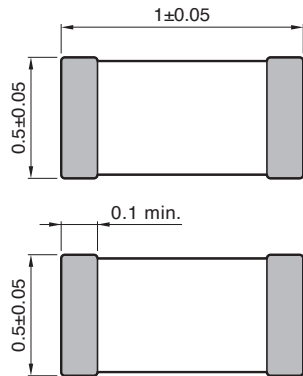

Electrode material  
Internal: Pd  
External: Ag/Ni/Sn  
Dimensions in mm

## RECOMMENDED LAND PATTERN

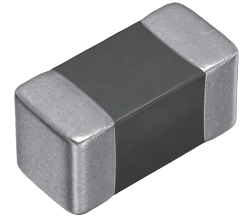
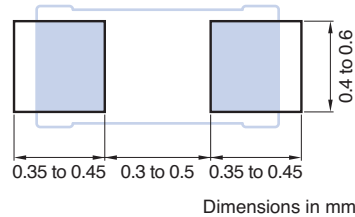

## PRODUCT CHARACTERISTICS LIST

Item	V1mA (V)	C 1kHz/1MHz* (pF)	Vdc		E 10/1000μs (J)	Ip 8/20μs (A)	Operating temperature range (°C)	ESD voltage tolerance IEC61000-4-2 (kV)
			DC (V)	Vcl 8/20μs (V)				
<a href="#">AVRL101D3R3FTA</a>	27(21.6 to 32.4)	3.3(2.3 to 4.3)*	20	62(0.5A)	0.01	0.5	-40 to 125	8
<a href="#">AVRL101D6R8GTA</a>	27(21.6 to 32.4)	6.8(4.8 to 8.8)*	20	58(1A)	0.01	1	-40 to 125	8

V1mA: Varistor voltage, C: Capacitance, Vdc: Maximum allowable circuit voltage, Vcl: Clamping voltage, E: Energy capacity, Ip: Surge current

# Chip varistors

## Automotive grade

RoHS Directive Compliant Product  
Compatible with lead-free solders  
AEC-Q200

# AVRH series 1005 type

## SHAPE & DIMENSIONS

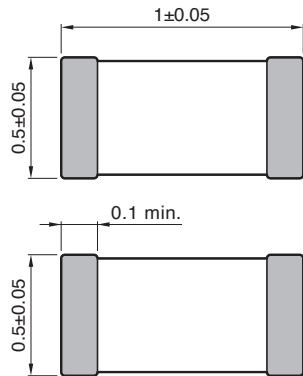

Electrode material  
Internal: Pd  
External: Ag/Ni/Sn  
Dimensions in mm

## RECOMMENDED LAND PATTERN

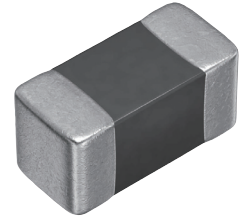
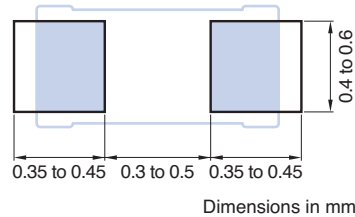

## PRODUCT CHARACTERISTICS LIST

Item	V1mA (V)	C 1kHz/1MHz* (pF)	Vdc Vcl		E 10/1000µs (J)	Ip 8/20µs (A)	Operating temperature range (°C)	ESD voltage tolerance IEC61000-4-2 (kV)
			DC (V)	8/20µs (V)				
<a href="#">AVRH10C220YT201MA8</a>	22(19 to 26)	200(160 to 240)	16	40(2A)	0.07	40	-55 to 150	25
<a href="#">AVRH10C270KT150NA8</a>	27(24 to 30)	15(10.5 to 19.5)	19	52(2A)	0.02	2	-55 to 150	25
<a href="#">AVRH10C270KT350NA8</a>	27(24 to 30)	35(24.5 to 45.5)	19	52(2A)	0.02	8	-55 to 150	25
<a href="#">AVRH10C390KT150NA8</a>	39(35 to 43)	15(10.5 to 19.5)	28	80(2A)	0.05	5	-55 to 150	25
<a href="#">AVRH10C390KT500NA8</a>	39(35 to 43)	50(35 to 65)	28	72(2A)	0.06	15	-55 to 150	25
<a href="#">AVRH10C101KT4R7FA8</a>	100(90 to 110)	4.7(3.7 to 5.7)*	70	190(1A)	0.03	1	-55 to 150	25
<a href="#">AVRH10C101KT4R7YA8</a>	115(103.5 to 126.5)	4.7(4.13 to 5.27)*	70	212(1A)	0.03	1	-55 to 150	25
<a href="#">AVRH10C101KT1R1NE8</a>	110(100 to 120)	1.1(0.8 to 1.4)*	70	187(0.3A)	0.007	0.3	-55 to 150	8
<a href="#">AVRH10C101KT1R2YE8</a>	110(100 to 120)	1.23(1.10 to 1.36)*	70	187(0.3A)	0.007	0.3	-55 to 150	8
<a href="#">AVRH10C221KT1R5YA8</a>	220(198 to 242)	1.5(1.37 to 1.63)*	70	400(0.5A)	0.007	0.5	-55 to 150	25

V1mA: Varistor voltage, C: Capacitance, Vdc: Maximum allowable circuit voltage, Vcl: Clamping voltage, E: Energy capacity, Ip: Surge current

Chip varistors  
Automotive grade

RoHS Directive Compliant Product  
Compatible with lead-free solders  
AEC-Q200

# AVR series 1608 type

**SHAPE & DIMENSIONS**

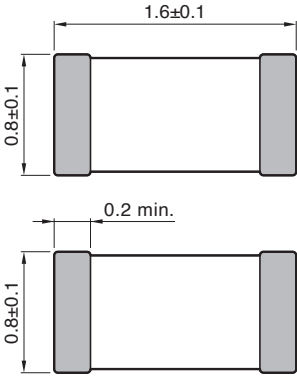

Electrode material  
Internal: Pd  
External: Ag/Ni/Sn  
Dimensions in mm

**RECOMMENDED LAND PATTERN**

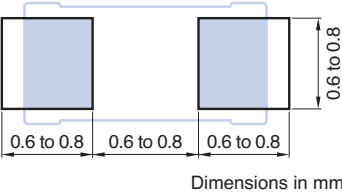

**PRODUCT CHARACTERISTICS LIST**

Item	V1mA	C	Vdc	Vcl	E	Ip	Operating temperature range (°C)	ESD voltage tolerance IEC61000-4-2 (kV)
	(V)	1kHz/1MHz* (pF)	DC (V)	8/20µs (V)	10/1000µs (J)	8/20µs (A)		
<a href="#">AVR-M1608C220KT2AB</a>	22(19.8 to 24.2)	210(168 to 252)	16	37(2A)	0.03	10	-40 to 125	25
<a href="#">AVR-M1608C220KT6AB</a>	22(19.8 to 24.2)	560(448 to 672)	16	34(2A)	0.1	30	-40 to 125	25
<a href="#">AVR-M1608C270MTABB</a>	27(21.6 to 32.4)	15(11 to 20)	17	52(2A)	0.05	2	-55 to 150	25
<a href="#">AVR-M1608C270MTAAB</a>	27(21.6 to 32.4)	30(21 to 39)	17	52(2A)	0.05	2	-55 to 150	25
<a href="#">AVR-M1608C270KTACB</a>	27(24 to 30)	60(42 to 78)	19	54(2A)	0.05	10	-55 to 150	25
<a href="#">AVRM1608C270KT800M</a>	27(24 to 30)	80(64 to 96)	19	53(2A)	0.02	28	-55 to 150	25
<a href="#">AVR-M1608C270KT2AB</a>	27(24 to 30)	160(128 to 192)	19	42(2A)	0.1	20	-55 to 150	25
<a href="#">AVRM1608C270KT221M</a>	27(24 to 30)	220(176 to 264)	19	52(2A)	0.1	56	-55 to 150	25
<a href="#">AVR-M1608C270KT6AB</a>	27(24 to 30)	430(344 to 516)	19	42(2A)	0.1	48	-55 to 150	25
<a href="#">AVR-M1608G270KT6AB</a>	27(24 to 30)	430(344 to 516)	19	42(2A)	0.1	48	-55 to 150	25
<a href="#">AVRM1608C390KT271N</a>	39(35 to 43)	270(189 to 351)	28	69(2A)	0.1	78	-55 to 150	25
<a href="#">AVRM1608C560KT101M</a>	56(50.4 to 61.6)	100(80 to 120)	40	113(2A)	0.3	60	-55 to 150	25
<a href="#">AVRM1608C720KT750M</a>	72(64.8 to 79.2)	75(60 to 90)	53	135(2A)	0.1	40	-55 to 150	25
<a href="#">AVRL161D3R3FTA</a>	27(21.6 to 32.4)	3.3(2.3 to 4.3)*	20	62(0.5A)	0.01	0.5	-40 to 125	8
<a href="#">AVRL161D6R8GTA</a>	27(21.6 to 32.4)	6.8(4.8 to 8.8)*	20	58(1A)	0.01	1	-40 to 125	8

V1mA: Varistor voltage, C: Capacitance, Vdc: Maximum allowable circuit voltage, Vcl: Clamping voltage, E: Energy capacity, Ip: Surge current

⚠ Please be sure to request delivery specifications that provide further details on the features and specifications of the products for proper and safe use. Please note that the contents may change without any prior notice due to reasons such as upgrading.

# Chip varistors

## Automotive grade

RoHS Directive Compliant Product  
Compatible with lead-free solders  
AEC-Q200

# AVRH series 1608 (Array) type

## SHAPE & DIMENSIONS

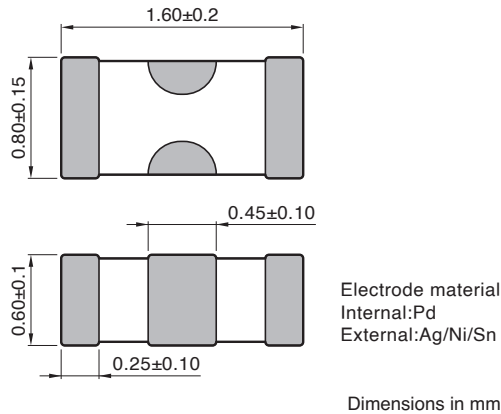

## RECOMMENDED LAND PATTERN

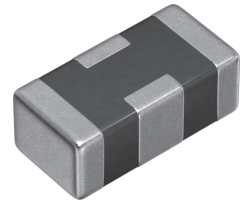
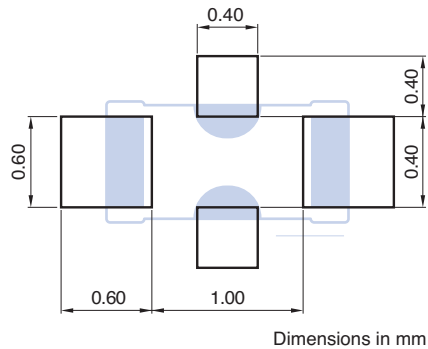

## PRODUCT CHARACTERISTICS LIST

Item	V1mA	C	Vdc	Vcl	E	I <sub>p</sub>	ΔC	Operating temperature range	ESD voltage tolerance
	(V)	1kHz/1MHz* (pF)	DC (V)	8/20μs (V)	10/1000μs (J)	8/20μs (A)	1MHz (pF)	(°C)	IEC61000-4-2 (kV)
<a href="#">AVRH16A2C270KT200NA8</a>	27(24 to 30)	20(14 to 26)	19	60(2A)	0.04	4	1.0	-55 to 150	25

V1mA: Varistor voltage, C: Capacitance, Vdc: Maximum allowable circuit voltage, Vcl: Clamping voltage, E: Energy capacity, I<sub>p</sub>: Surge current, ΔC: Capacitance difference

# Chip varistors

## Automotive grade

RoHS Directive Compliant Product  
Compatible with lead-free solders  
AEC-Q200

# AVR series 2012 type

## SHAPE & DIMENSIONS

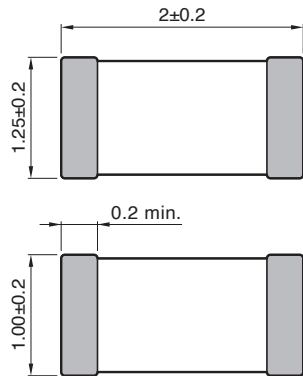

Electrode material  
Internal: Pd  
External: Ag/Ni/Sn

Dimensions in mm

## RECOMMENDED LAND PATTERN

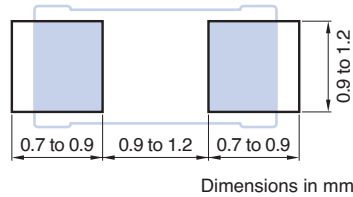

## PRODUCT CHARACTERISTICS LIST

Item	V1mA (V)	C 1kHz/1MHz* (pF)	Vdc		E		Ip 8/20μs (A)	Operating temperature range (°C)	ESD voltage tolerance IEC61000-4-2 (kV)
			DC (V)	Vcl 8/20μs (V)	10/1000μs (J)	8/20μs (A)			
<a href="#">AVR-M2012C220KT6AB</a>	22(19.8 to 24.2)	800(560 to 1040)	16	38(5A)	0.3	100	-40 to 125	25	
<a href="#">AVRM2012C330KT801N</a>	33(30 to 36)	800(560 to 1040)	24	59(5A)	0.5	240	-55 to 150	25	
<a href="#">AVR-M2012C390KT6AB</a>	39(35 to 43)	430(301 to 559)	28	62(5A)	0.3	100	-55 to 150	25	
<a href="#">AVRM2012C560KT251M</a>	56(50.4 to 61.6)	250(200 to 300)	40	113(5A)	0.3	150	-55 to 150	25	
<a href="#">AVRM2012C720KT201M</a>	72(64.8 to 79.2)	200(160 to 240)	53	142(5A)	0.3	100	-55 to 150	25	

V1mA: Varistor voltage, C:Capacitance, Vdc:Maximum allowable circuit voltage, Vcl:Clamping voltage, E:Energy capacity, Ip:Surge current

# Chip varistors

## Automotive grade

RoHS Directive Compliant Product  
Compatible with lead-free solders  
AEC-Q200

## AVR series Electrostatic absorption characteristics

### DISCHARGE VOLTAGE WAVEFORM (EXAMPLE)

Without varistor, waveform at varistor installation

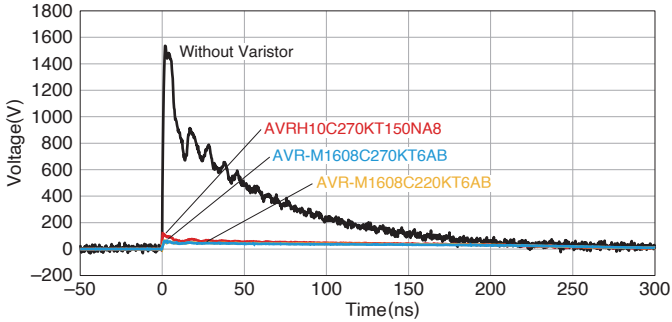

Waveform at varistor installation

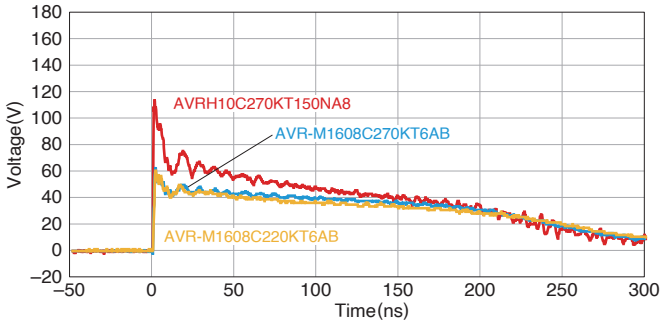

Test conditions

150pF/330Ω (IEC61000-4-2)  
Contact discharge, Charged voltage 8kV

Test circuit diagram

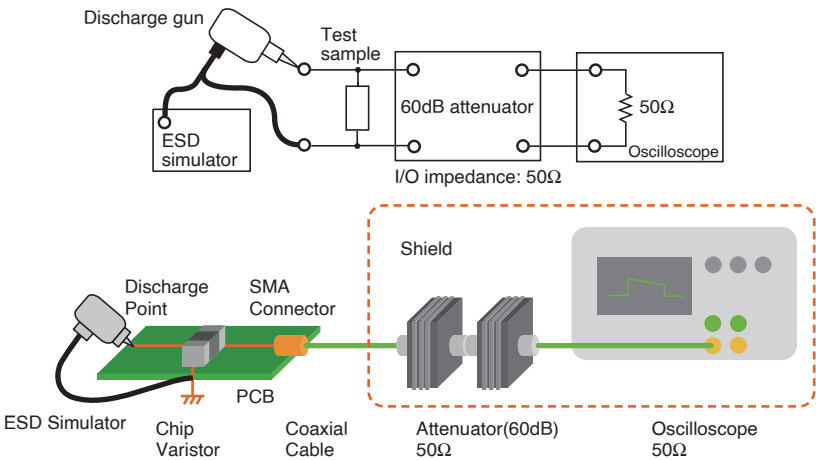

⚠ Please be sure to request delivery specifications that provide further details on the features and specifications of the products for proper and safe use. Please note that the contents may change without any prior notice due to reasons such as upgrading.

# Chip varistors

## Automotive grade

RoHS Directive Compliant Product  
Compatible with lead-free solders  
AEC-Q200

### AVR series Electrostatic discharge tests

#### APPLIED VOLTAGE STEP(VOLTAGE 10TIMES APPLIED)

#### REPEATED VOLTAGE APPLICATION(~1000 times)

##### AVRH10C270KT150NA8

(Voltage % change at reference current: within ±10%)

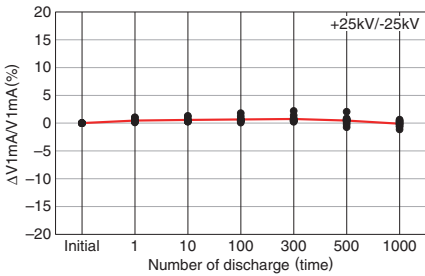
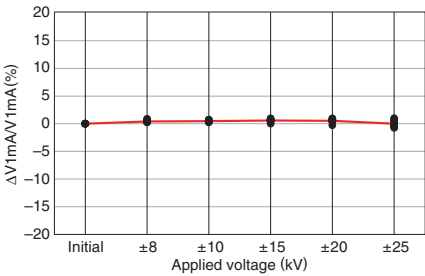

##### AVR-M1608C270MTAAB

(Voltage % change at reference current: within ±10%)

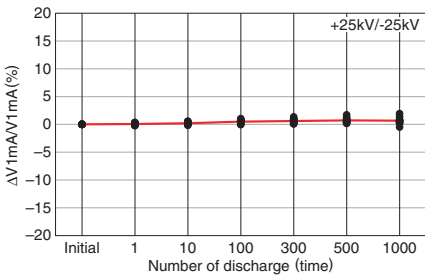
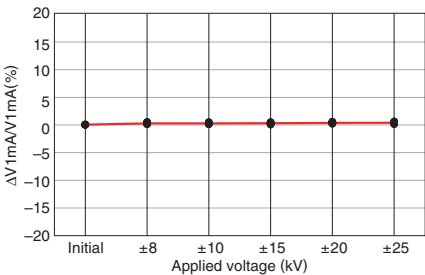

##### AVR-M2012C390KT6AB

(Voltage % change at reference current: within ±10%)

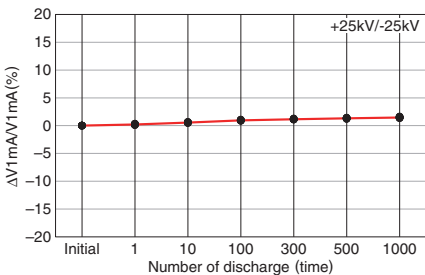
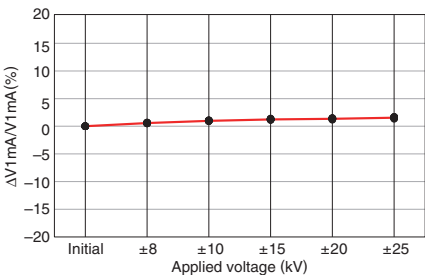

##### AVRL101D3R3FTA

(Capacitance: 5pF or less)

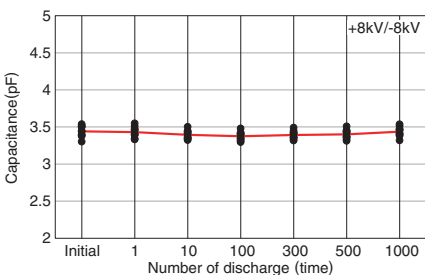
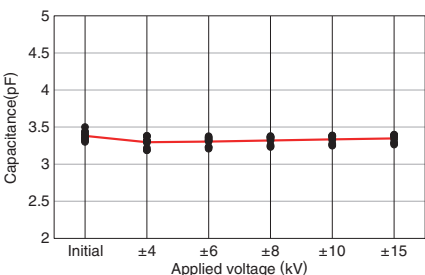

\* ESD condition: 150pF/330Ω(IEC61000-4-2)

Please be sure to request delivery specifications that provide further details on the features and specifications of the products for proper and safe use. Please note that the contents may change without any prior notice due to reasons such as upgrading.

# Chip varistors

## Automotive grade

RoHS Directive Compliant Product  
Compatible with lead-free solders  
AEC-Q200

# Attention on a circuit board design

### BOARD DESIGN

When attached to chip varistors, amount of silver used (fillet size) has direct impact on chip varistors after mounting. Thus, sufficient consideration is necessary.

#### Set of land dimensions

(1) As the stress rises in the chip varistors owing to the increase in silver, breakage and cracks will occur. Cause including crack, as caution on board land design, configure the shape and dimensions so that the amount of silver is appropriate. If you installed 2 or more parts in the Common Land, separated by a solder resist and special land of each component.

(2) When peak levels panning-at soldering is excessive, by solder contraction stress, mechanical-thermal stress causes a Yasuku chip crack. In addition, when the peak level is underestimated, terminal electrode fixed strength is insufficient. This causes chip dropouts and may affect circuit reliability. Representative example of the panning of peak levels is shown in the following.

#### Recommended silver dose

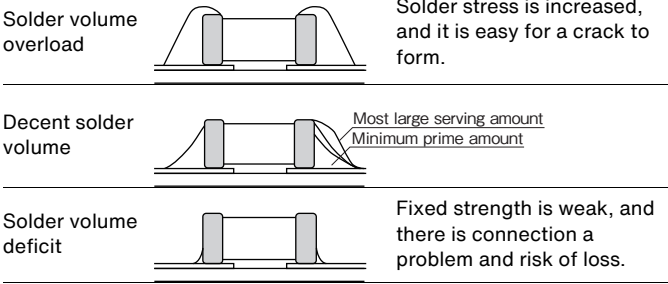

#### Recommended silver dose

Example	Cases to avoid	Improvement example (land division)
Lead wire and land of part discrete doubles up		
Arrangements in the vicinity		
Arrangements of chip component\qs companion		

⚠ Please be sure to request delivery specifications that provide further details on the features and specifications of the products for proper and safe use. Please note that the contents may change without any prior notice due to reasons such as upgrading.

# Chip varistors Automotive grade

RoHS Directive Compliant Product  
Compatible with lead-free solders  
AEC-Q200

## Attention on a circuit board design

### Arrangements of components

(1) I was based on camber of substrate and suggested protocol of chip varistors arrangement, as stress does not join to the utmost is shown in following.

(2) In payment near by board, depending on mount position of chip varistors, as mechanical stress varies, please refer to the following diagram.

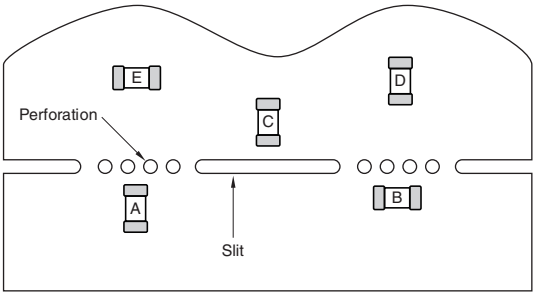
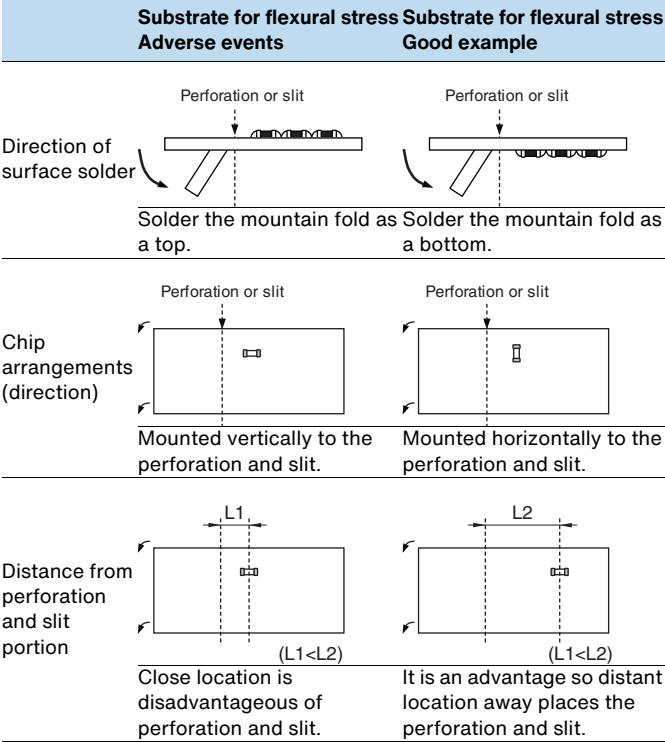

The order of A > B = C > D > E eases the stress.

 Please be sure to request delivery specifications that provide further details on the features and specifications of the products for proper and safe use. Please note that the contents may change without any prior notice due to reasons such as upgrading.

# Chip varistors

## Automotive grade

RoHS Directive Compliant Product  
Compatible with lead-free solders  
AEC-Q200

# Local precautions

## Application to board

### Mounting head pressure

Under suction nozzle if dead point too, during implementation, excessive force joins of chip varistors low, as cause causes of crack, please use with reference to something about following.

- 1) Being set to top surface of substrate so that under suction nozzle as for dead center, substrate does not bend back, and adjust, please.
- 2) Nozzle pressure at implementation is 1N to 3N in static load, please.
- 3) Substrate fixes up back surface of substrate with support pin in impact of suction nozzle to wely deflection to the utmost, and substrate hold deflection, please.

A representative example is shown in the following.

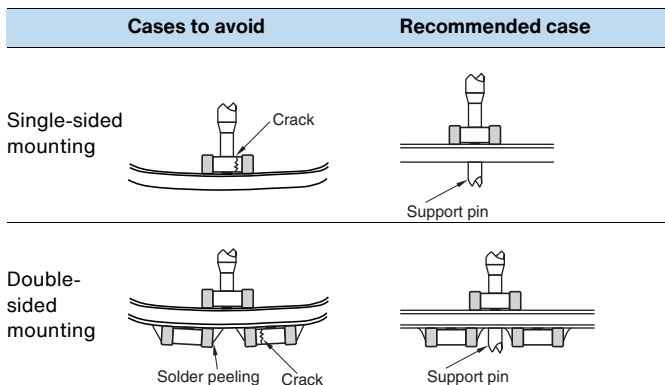

Mechanical shock that, if positioning your nail to wear, ragged edge of positionings, participates in chip varistors are locally, and chip varistors, as there is possibility of crack generated, cut the closed positioning, and maintenance and inspection, and, exchange of manage dimensions and position nail periodically, please.

## Soldering

Significant impact is possible on the performance of chip varistors, flux checks something about follow, please use.

- (1) Flux uses one with 0.1wt % (Cl conversion) or less halide substance contains amounts, please. In addition, do not do this with strongly acidic objects.
- (2) When soldering the chip varistor to the circuit board, please apply the flux in the minimum necessary amount.
- (3) If Used soluble flux, perform thorough wash particularly, please.

## Reflow temperature profile

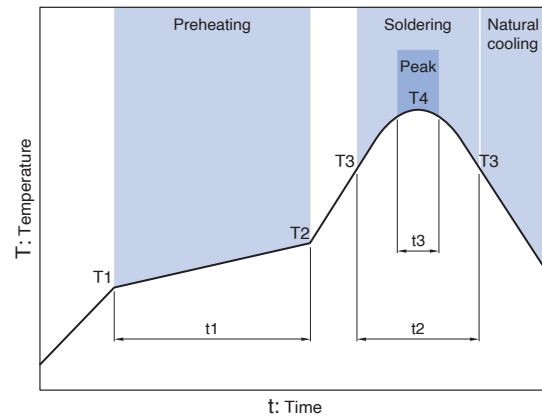

Item	Specification	
	For eutectic mixture solder	For lead-free solder
Preheating temperature	160 to 180°C	150 to 180°C
Solder melting temperature	200°C	230°C
Maximum temperature	240°C max.	260°C max.
Preheating time	100s max.	120s max.
Time to reach higher than the solder melting temperature	30s max.	40s max.
number of possible reflow cycles	2 max.	2 max.

## Soldering iron

- (1) The tip temperature and also by (1)types of soldering irons, the size of the substrate, and the geometry of the land pattern. Being earlier, but when as there is possibility that crack occurs in the heat anderson impaction, point soldering iron temperature is high, please do solder work within the following conditions.

Temperature of iron tips (°C)	Wattage (W)	Palet point shape (mm)	Soldering time (Second)	Number of times
350max.	30max.	ø3.0max.	5 max.	Within each terminal once (Within total of twice)

- (2) Direct contact between the soldering iron tip and the body of the chip varistor can cause particularly large strains due to thermal shock, and may result in cracks. Therefore, please ensure that you do not touch any part other than the terminal electrodes directly.

# Chip varistors

## Automotive grade

RoHS Directive Compliant Product  
Compatible with lead-free solders  
AEC-Q200

# Attention after implementation

## Cleaning

- (1) If cleaning liquid is inappropriate, residues and other foreign body of fluxes builds up on chip varistors, and can degrade the performance of chip varistors (particularly the insulation resistance).
- (2) Wash conditions may compromise performance of chip varistors if they are improper (wash due, wash excess).

### 2-1) For wash due

- (a) By substance of a system in flux residue halide, metal including terminal electrodes may experience corrosion.
- (b) Substance of a system in flux residue halide builds up on chip varistors, and reduces the insulation resistance.
- (c) Soluble flux makes comparisons of colophony series flux, and there is event with trends of significant (1) and(2).

### 2-2) For excess wash

- (1) Owing to lavage, chip varistors deteriorates, and reduces performance of chip varistors.
- (2) In ultrasonography, when output is passed, substrate resonates size, and crack occurs in body and sprang of chip varistors in vibration of substrate. Since this may reduce the strength of the terminal electrode, please note the following conditions. [Please review the italicized portion, as I am unsure what you mean to convey here.]  
 Ultrasound output : 20W/liter or less  
 Ultrasound frequency : 40kHz or less  
 Cleaning time : 5minutes or less

- 2-3) Concentration including halogen that when cleaning liquid to pollution, when you released is higher, and may cause similar of results into wash due.

## Substrate handling after component mounting

- (1) When substrate is divided, a flexible so that show in following diagram to substrate, and is given by stress including twist, as there is possibility that crack occurs of chip varistors, please check that stress is within acceptable limits.

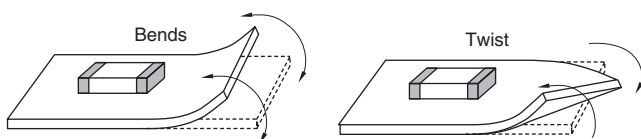

- (2) During each substrate operational check, push pressure with contact failure of check pin of boards checkers of check pin may be toned up to be prevented. As substrate is bent under loading, chip varistors is broken owing to stress. There is also the possibility that solder on the terminal electrode will peel off. Follow the diagram for reference, and check that the substrate bends, please.

Item	Cases to avoid	Recommended case
Substrate sags		

## Single-part component handling

- (1) Chip varistors can be damaged or cracked due to impact from falling. Therefore, please do not use chip varistors that have been dropped.

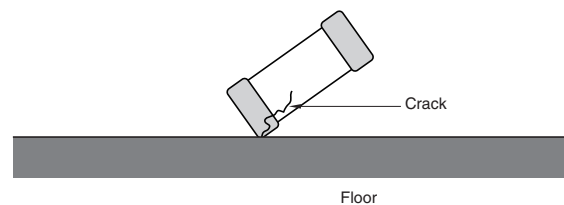

- (2) At stacking storage after implementation and treatment of substrate, corner of boards is regarded as chip varistors. Please be careful, as there is the possibility that breakage and cracks will occur on impact.

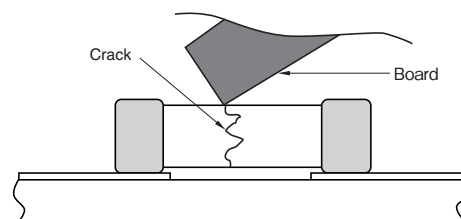



## Looking for pricing, stock, or lifecycle information?

Click below to explore more details on WIN SOURCE:

- ⊖ [View AVRL161D3R3FTA on WIN SOURCE](#)
- ⊖ [TDK Corporation](#) Information

## Optimize Your Supply Chain with WIN SOURCE Solutions

- ✓ Global Sourcing Solution
- ✓ Obsolete Management
- ✓ Cost Control Management
- ✓ Shortage Management
- ✓ Alternative Solution
- ✓ Excess Inventory Management