



## IRS2181/IRS21814(S)PbF

### HIGH AND LOW SIDE DRIVER

#### Features

- Floating channel designed for bootstrap operation
- Fully operational to +600 V
- Tolerant to negative transient voltage, dV/dt immune
- Gate drive supply range from 10 V to 20 V
- Undervoltage lockout for both channels
- 3.3 V and 5 V input logic compatible
- Matched propagation delay for both channels
- Logic and power ground +/- 5 V offset
- Lower di/dt gate driver for better noise immunity
- Output source/sink current capability 1.4 A/1.8 A
- RoHS compliant

#### Packages

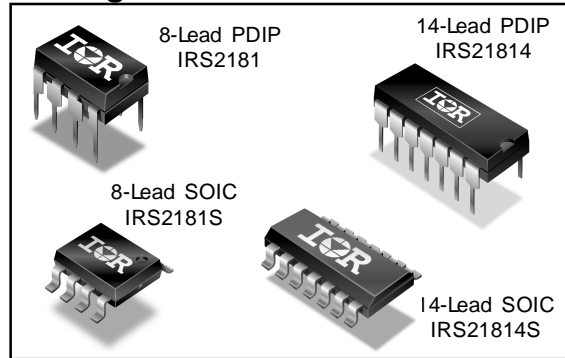

#### Description

The IRS2181/IRS21814 are high voltage, high speed power MOSFET and IGBT drivers with independent high-side and low-side referenced output channels. Proprietary HVIC and latch immune CMOS technologies enable ruggedized monolithic construction. The logic input is compatible with standard CMOS or LSTTL output, down to 3.3 V logic. The output drivers feature a high pulse current buffer stage designed for minimum driver cross-conduction. The floating channel can be used to drive an N-channel power MOSFET or IGBT in the high-side configuration which operates up to 600 V.

#### Feature Comparison

Part	Input logic	Cross-conduction prevention logic	Deadtime (ns)	Ground Pins	ton/off (ns)
2181	HIN/LIN	no	none	COM	180/220
21814				V <sub>SS</sub> /COM	
2183	HIN/LIN	yes	Internal 400 Program 400-5000	COM	180/220
21834				V <sub>SS</sub> /COM	
2184	IN/SD	yes	Internal 400 Program 400-5000	COM	680/270
21844				V <sub>SS</sub> /COM	

#### Typical Connection

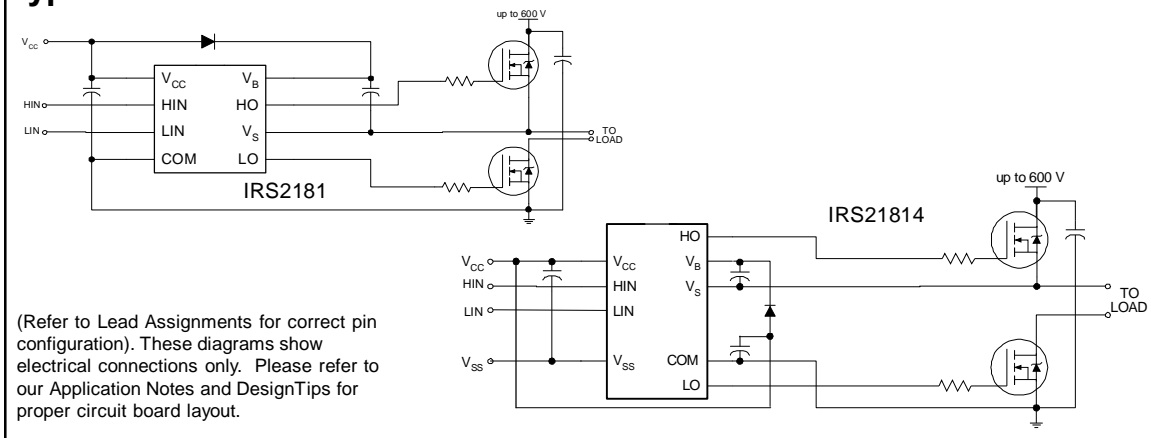

## Absolute Maximum Ratings

Absolute maximum ratings indicate sustained limits beyond which damage to the device may occur. All voltage parameters are absolute voltages referenced to COM. The thermal resistance and power dissipation ratings are measured under board mounted and still air conditions.

Symbol	Definition	Min.	Max.	Units	
V <sub>B</sub>	High-side floating absolute voltage	-0.3	620 (Note 1)	V	
V <sub>S</sub>	High-side floating supply offset voltage	V <sub>B</sub> - 20	V <sub>B</sub> + 0.3		
V <sub>HO</sub>	High-side floating output voltage	V <sub>S</sub> - 0.3	V <sub>B</sub> + 0.3		
V <sub>CC</sub>	Low-side and logic fixed supply voltage	-0.3	20 (Note 1)		
V <sub>LO</sub>	Low-side output voltage	-0.3	V <sub>CC</sub> + 0.3		
V <sub>IN</sub>	Logic input voltage (HIN & LIN)	V <sub>SS</sub> - 0.3	V <sub>CC</sub> + 0.3		
V <sub>SS</sub>	Logic ground (IRS21814 only)	V <sub>CC</sub> - 20	V <sub>CC</sub> + 0.3		
dV <sub>S</sub> /dt	Allowable offset supply voltage transient	—	50	V/ns	
P <sub>D</sub>	Package power dissipation @ T <sub>A</sub> ≤ +25 °C	(8-lead PDIP)	—	1.0	W
		(8-lead SOIC)	—	0.625	
		(14-lead PDIP)	—	1.6	
		(14-lead SOIC)	—	1.0	
R <sub>thJA</sub>	Thermal resistance, junction to ambient	(8-lead PDIP)	—	125	°C/W
		(8-lead SOIC)	—	200	
		(14-lead PDIP)	—	75	
		(14-lead SOIC)	—	120	
T <sub>J</sub>	Junction temperature	—	150	°C	
T <sub>S</sub>	Storage temperature	-50	150		
T <sub>L</sub>	Lead temperature (soldering, 10 seconds)	—	300		

Note 1: All supplies are fully tested at 25 V and an internal 20 V clamp exists for each supply.

## Recommended Operating Conditions

The input/output logic timing diagram is shown in Fig. 1. For proper operation the device should be used within the recommended conditions. The V<sub>S</sub> and V<sub>SS</sub> offset rating are tested with all supplies biased at a 15 V differential.

Symbol	Definition	Min.	Max.	Units
V <sub>B</sub>	High-side floating supply absolute voltage	V <sub>S</sub> + 10	V <sub>S</sub> + 20	V
V <sub>S</sub>	High-side floating supply offset voltage	Note 2	600	
V <sub>HO</sub>	High-side floating output voltage	V <sub>S</sub>	V <sub>B</sub>	
V <sub>CC</sub>	Low-side and logic fixed supply voltage	10	20	
V <sub>LO</sub>	Low-side output voltage	0	V <sub>CC</sub>	
V <sub>IN</sub>	Logic input voltage (HIN & LIN)	V <sub>SS</sub>	V <sub>CC</sub>	
V <sub>SS</sub>	Logic ground (IRS21814 only)	-5	5	
T <sub>A</sub>	Ambient temperature	-40	125	°C

Note 2: Logic operational for V<sub>S</sub> of -5 V to +600 V. Logic state held for V<sub>S</sub> of -5 V to -V<sub>BS</sub>. (Please refer to the Design Tip DT97-3 for more details).

## Dynamic Electrical Characteristics

$V_{BIAS}$  ( $V_{CC}$ ,  $V_{BS}$ ) = 15 V,  $V_{SS}$  = COM,  $C_L$  = 1000 pF,  $T_A$  = 25 °C.

Symbol	Definition	Min.	Typ.	Max.	Units	Test Conditions
$t_{on}$	Turn-on propagation delay	—	180	270	ns	$V_S = 0$ V
$t_{off}$	Turn-off propagation delay	—	220	330		$V_S = 0$ V or 600 V
MT	Delay matching, HS & LS turn-on/off	—	0	35		
$t_r$	Turn-on rise time	—	40	60		$V_S = 0$ V
$t_f$	Turn-off fall time	—	20	35		

## Static Electrical Characteristics

$V_{BIAS}$  ( $V_{CC}$ ,  $V_{BS}$ ) = 15 V,  $V_{SS}$  = COM and  $T_A$  = 25 °C unless otherwise specified. The  $V_{IL}$ ,  $V_{IH}$ , and  $I_{IN}$  parameters are referenced to  $V_{SS}/COM$  and are applicable to the respective input leads HIN and LIN. The  $V_O$ ,  $I_O$ , and  $R_{ON}$  parameters are referenced to COM and are applicable to the respective output leads: HO and LO.

Symbol	Definition	Min.	Typ.	Max.	Units	Test Conditions
$V_{IH}$	Logic "1" input voltage	2.5	—	—	V	$V_{CC} = 10$ V to 20 V
$V_{IL}$	Logic "0" input voltage	—	—	0.8		
$V_{OH}$	High level output voltage, $V_{BIAS} - V_O$	—	—	1.4		
$V_{OL}$	Low level output voltage, $V_O$	—	—	0.2		
$I_{LK}$	Offset supply leakage current	—	—	50	$\mu$ A	$V_B = V_S = 600$ V
$I_{QBS}$	Quiescent $V_{BS}$ supply current	20	60	150		$V_{IN} = 0$ V or 5 V
$I_{QCC}$	Quiescent $V_{CC}$ supply current	50	120	240		
$I_{IN+}$	Logic "1" input bias current	—	25	60		$V_{IN} = 5$ V
$I_{IN-}$	Logic "0" input bias current	—	—	5.0		$V_{IN} = 0$ V
$V_{CCUV+}$ $V_{BSUV+}$	$V_{CC}$ and $V_{BS}$ supply undervoltage positive going threshold	8.0	8.9	9.8	V	
$V_{CCUV-}$ $V_{BSUV-}$	$V_{CC}$ and $V_{BS}$ supply undervoltage negative going threshold	7.4	8.2	9.0		
$V_{CCUVH}$ $V_{BSUVH}$	Hysteresis	0.3	0.7	—		
$I_{O+}$	Output high short circuit pulsed current	1.4	1.9	—	A	$V_O = 0$ V, $PW \leq 10$ $\mu$ s
$I_{O-}$	Output low short circuit pulsed current	1.8	2.3	—		$V_O = 15$ V, $PW \leq 10$ $\mu$ s

## Functional Block Diagrams

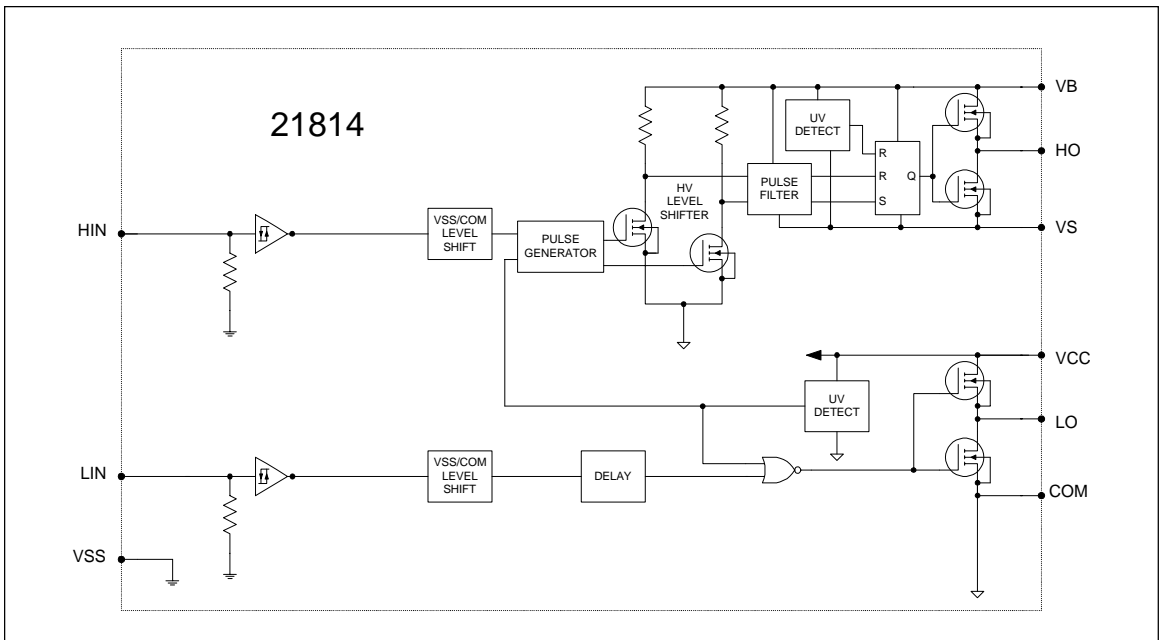
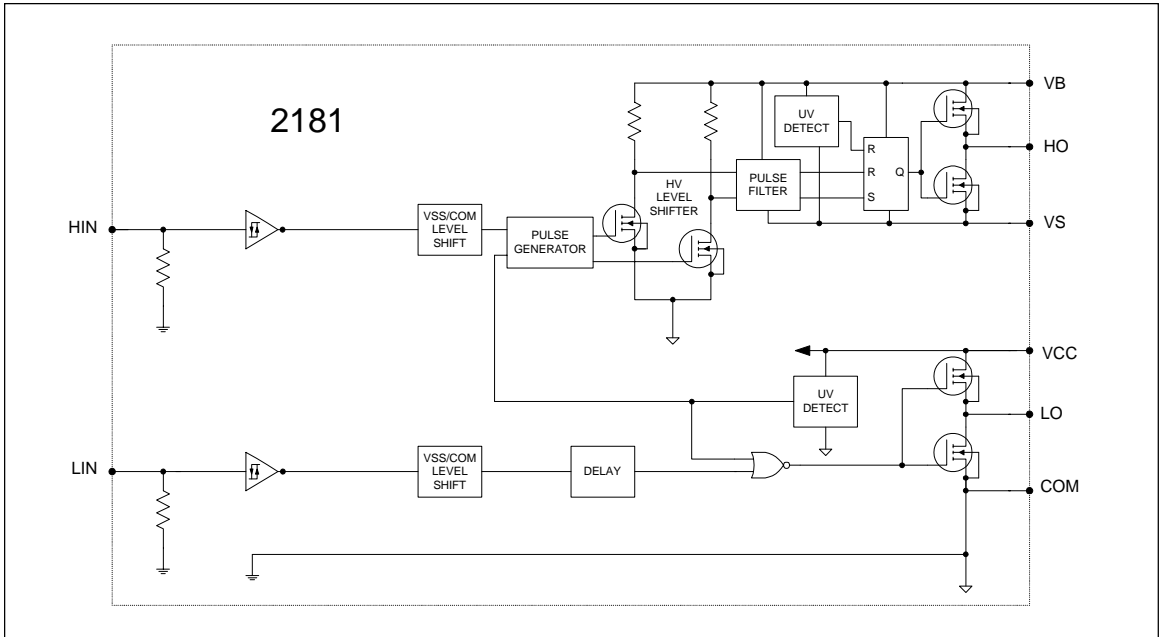

## Lead Definitions

Symbol	Description
HIN	Logic input for high-side gate driver output (HO), in phase (IRS2181/IRS21814)
LIN	Logic input for low-side gate driver output (LO), in phase (IRS2181/IRS21814)
VSS	Logic ground (IRS21814 only)
V <sub>B</sub>	High-side floating supply
HO	High-side gate drive output
V <sub>S</sub>	High-side floating supply return
V <sub>CC</sub>	Low-side and logic fixed supply
LO	Low-side gate drive output
COM	Low-side return

## Lead Assignments

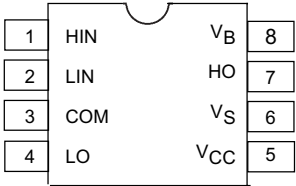
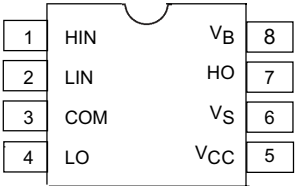
 <p>8-Lead PDIP</p>	 <p>8-Lead SOIC</p>
<b>IRS2181PbF</b>	<b>IRS2181SPbF</b>

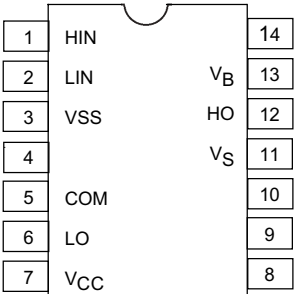
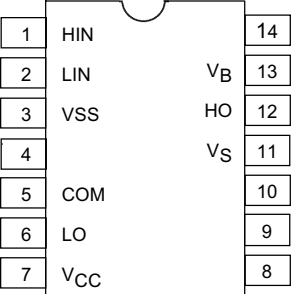
 <p>14-Lead PDIP</p>	 <p>14-Lead SOIC</p>
<b>IRS21814PbF</b>	<b>IRS21814SPbF</b>

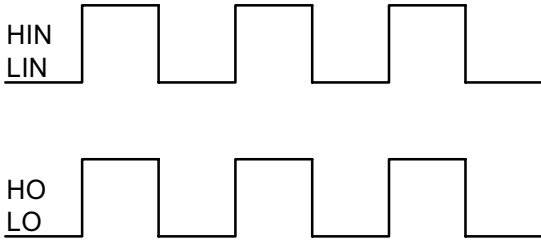

Figure 1. Input/Output Timing Diagram

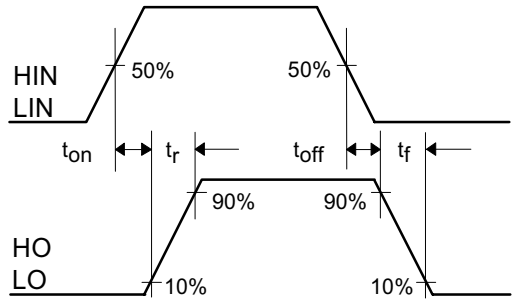

Figure 2. Switching Time Waveform Definitions

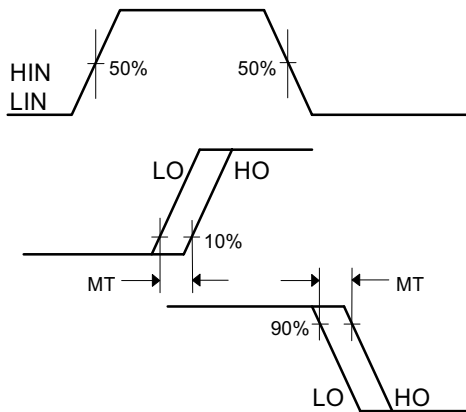
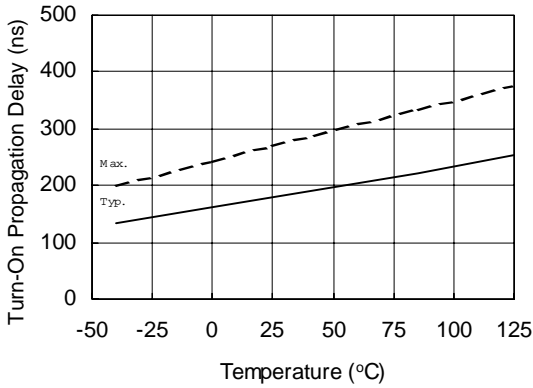
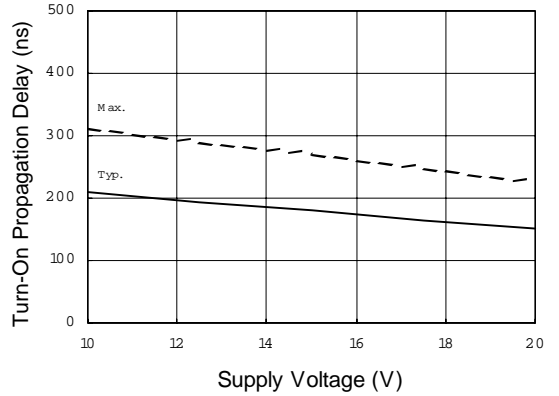

Figure 3. Delay Matching Waveform Definitions



**Figure 4A. Turn-On Propagation Delay vs. Temperature**



**Figure 4B. Turn-On Propagation Delay vs. Supply Voltage**

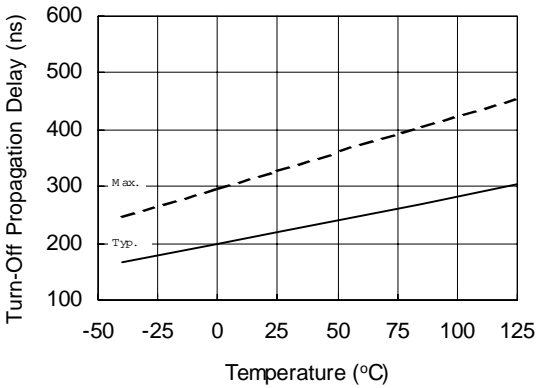

**Figure 5A. Turn-Off Propagation Delay vs. Temperature**

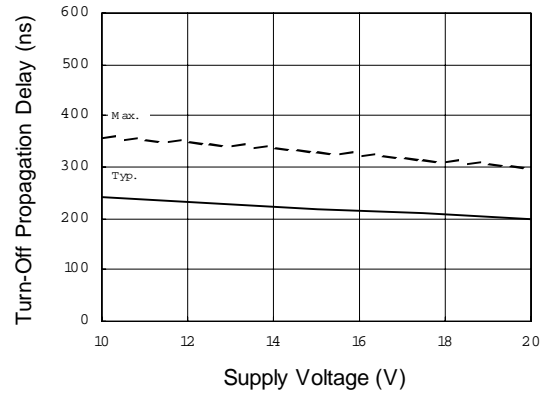

**Figure 5B. Turn-Off Propagation Delay vs. Supply Voltage**

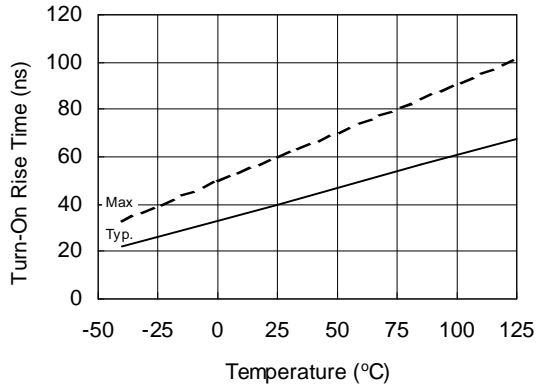

**Figure 6A. Turn-On Rise Time vs. Temperature**

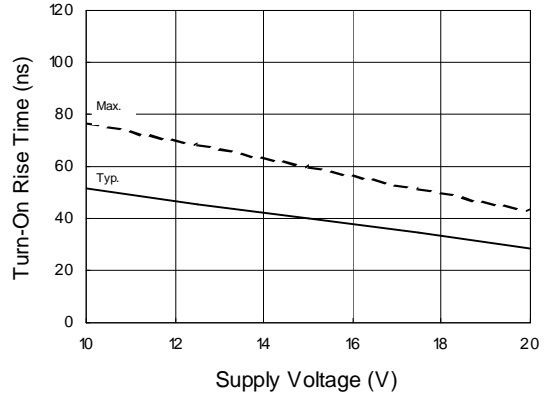

**Figure 6B. Turn-On Rise Time vs. Supply Voltage**

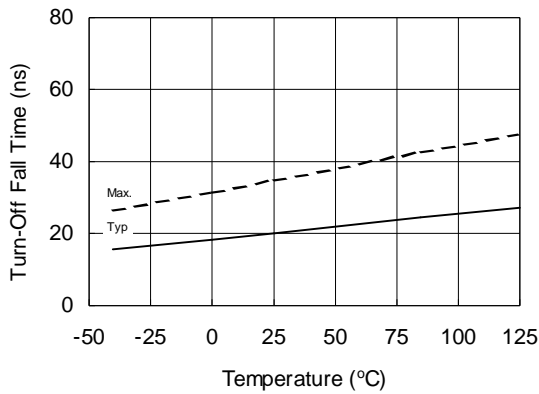

**Figure 7A. Turn-Off Fall Time vs. Temperature**

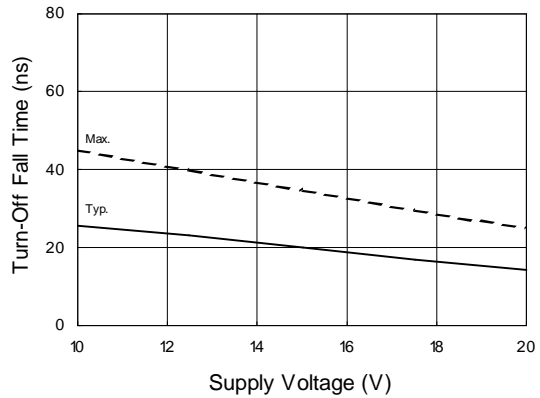

**Figure 7B. Turn-Off Fall Time vs. Supply Voltage**

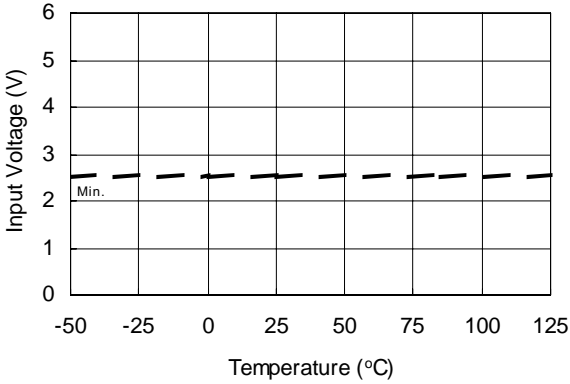

**Figure 8A. Logic "1" Input Voltage vs. Temperature**

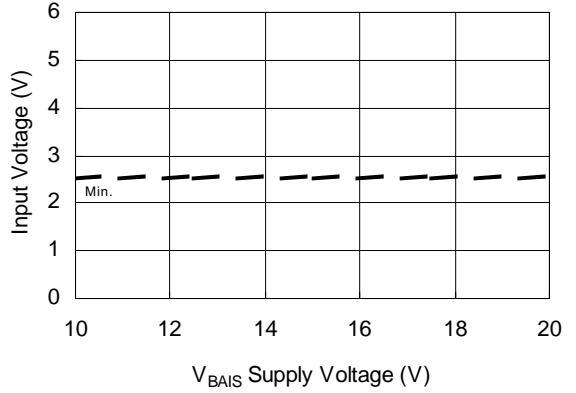

**Figure 8B. Logic "1" Input Voltage vs. Supply Voltage**

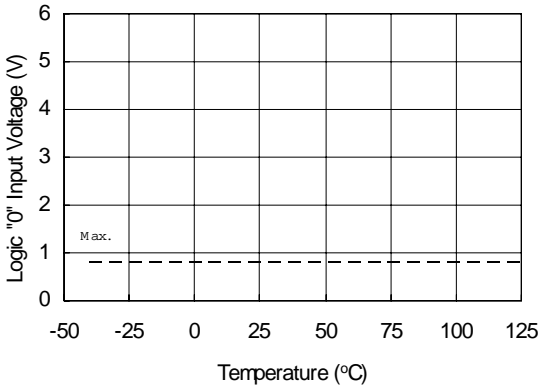

**Figure 9A. Logic "0" Input Voltage vs. Temperature**

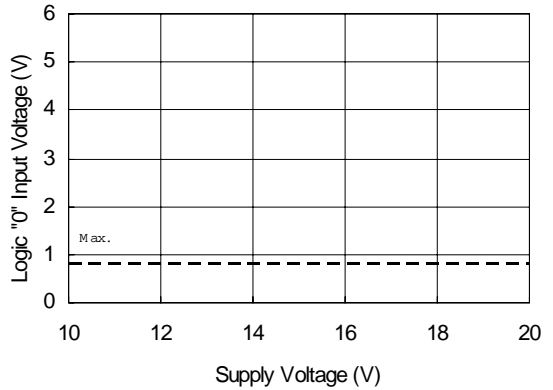

**Figure 9B. Logic "0" Input Voltage vs. Supply Voltage**

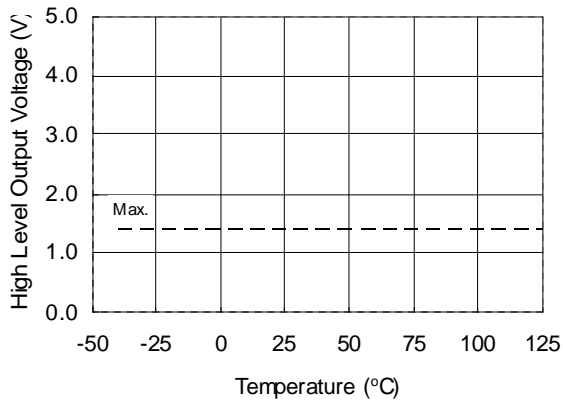

**Figure 10A. High Level Output Voltage vs. Temperature ( $I_o = 0$  mA)**

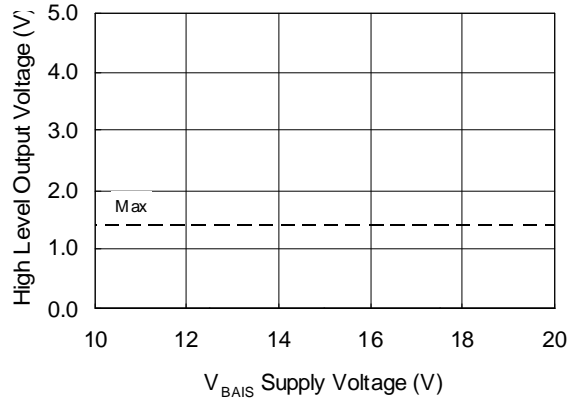

**Figure 10B. High Level Output Voltage vs. Supply Voltage ( $I_o = 0$  mA)**

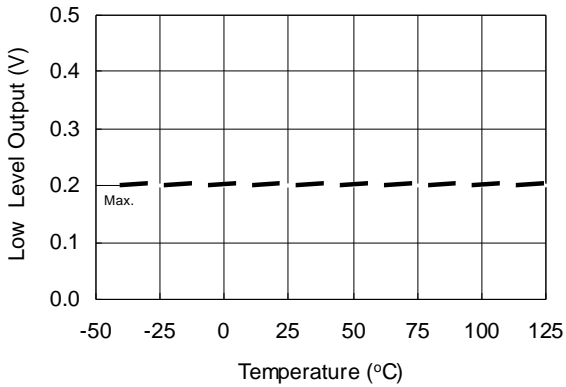

**Figure 11A. Low Level Output vs. Temperature**

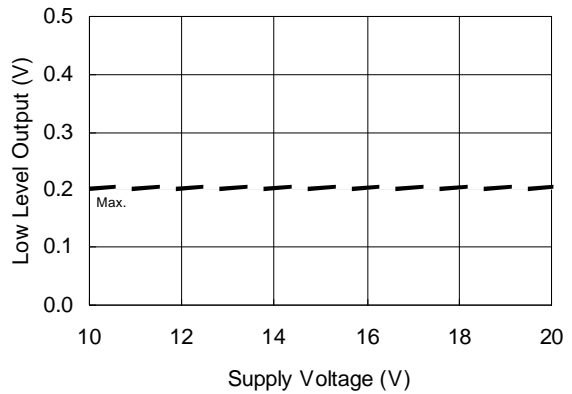

**Figure 11B. Low Level Output vs. Supply Voltage**

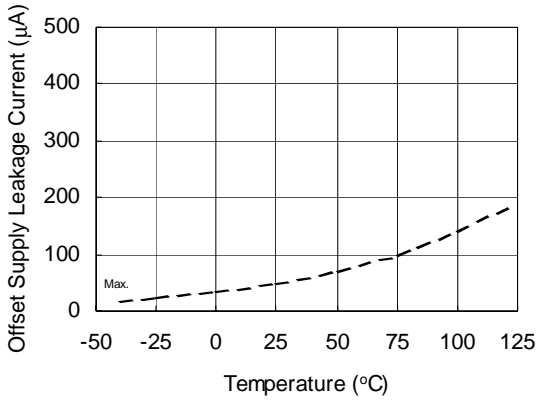

**Figure 12A. Offset Supply Leakage Current vs. Temperature**

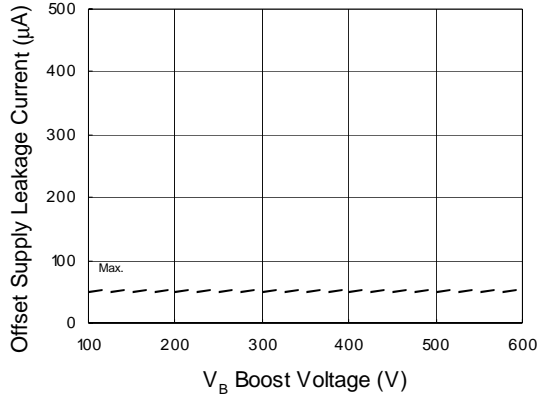

**Figure 12B. Offset Supply Leakage Current vs. V<sub>B</sub> Boost Voltage**

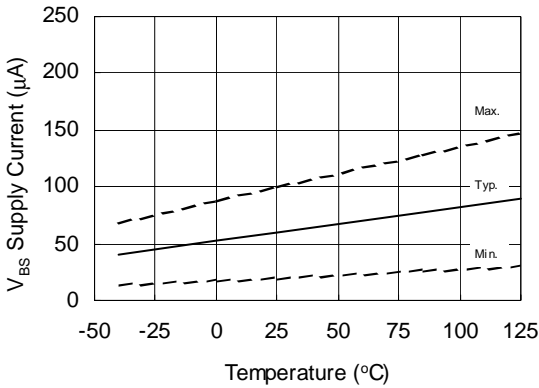

**Figure 13A. V<sub>BS</sub> Supply Current vs. Temperature**

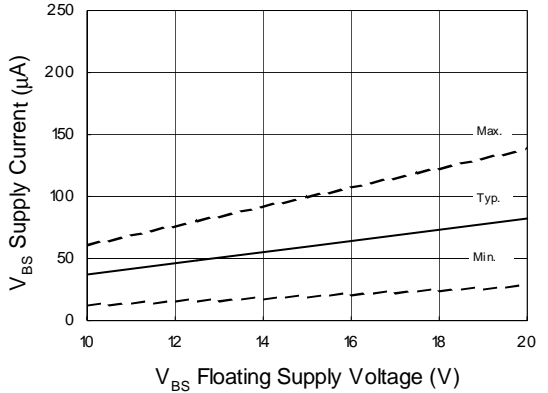

**Figure 13B. V<sub>BS</sub> Supply Current vs. V<sub>BS</sub> Floating Supply Voltage**

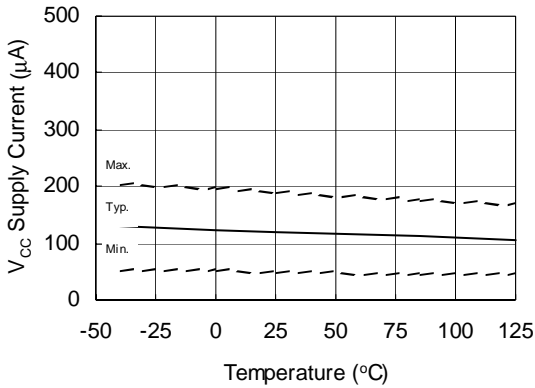

**Figure 14A.  $V_{CC}$  Supply Current vs.  $V_{CC}$  Temperature**

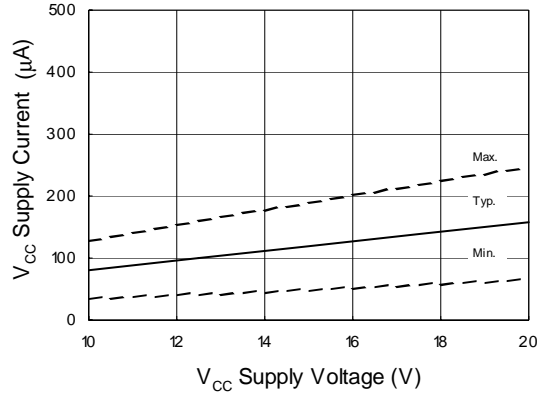

**Figure 14B.  $V_{CC}$  Supply Current vs.  $V_{CC}$  Supply Voltage**

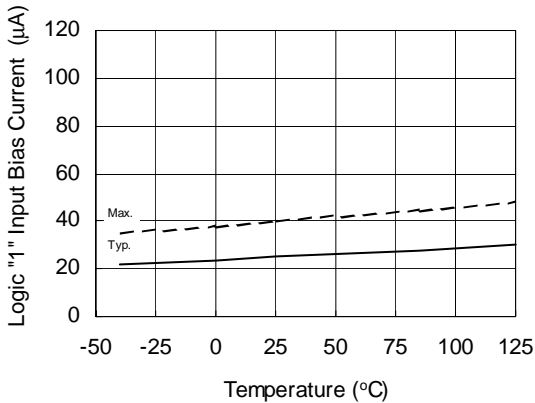

**Figure 15A. Logic "1" Input Bias Current vs. Temperature**

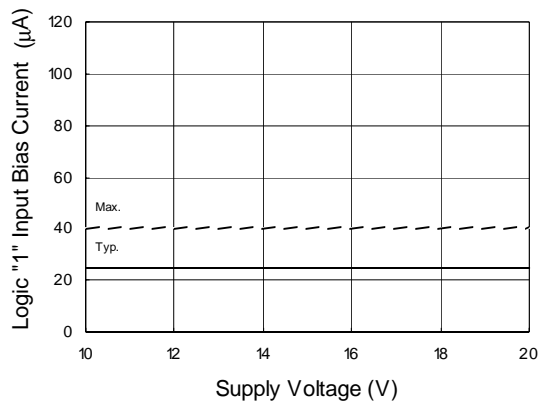

**Figure 15B. Logic "1" Input Bias Current vs. Supply Voltage**

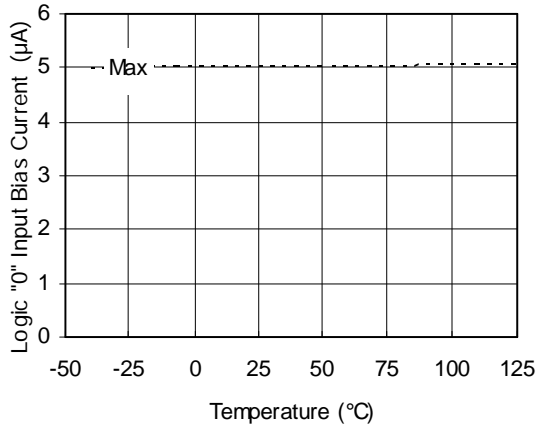

**Figure 16A. Logic "0" Input Bias Current vs. Temperature**

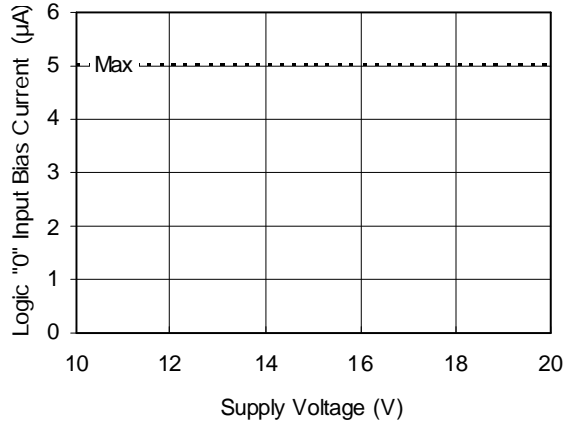

**Figure 16B. Logic "0" Input Bias Current vs. Voltage**

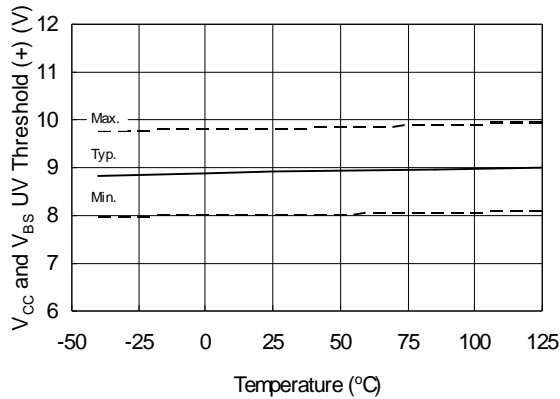

**Figure 17. V<sub>CC</sub> and V<sub>BS</sub> Undervoltage Threshold (+) vs. Temperature**

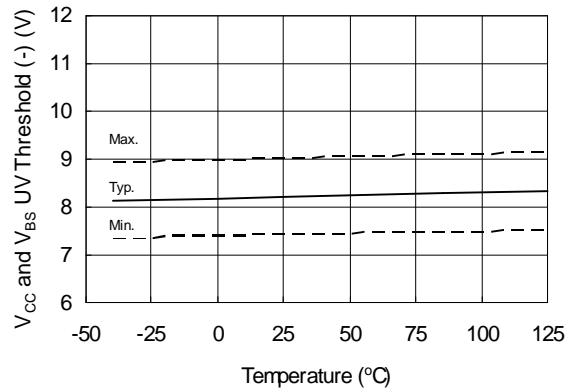

**Figure 18. V<sub>CC</sub> and V<sub>BS</sub> Undervoltage Threshold (-) vs. Temperature**

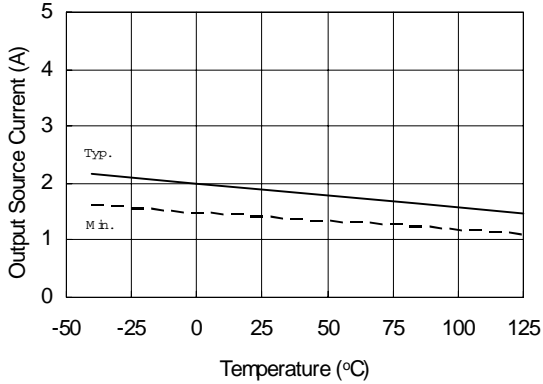

**Figure 19A. Output Source Current vs. Temperature**

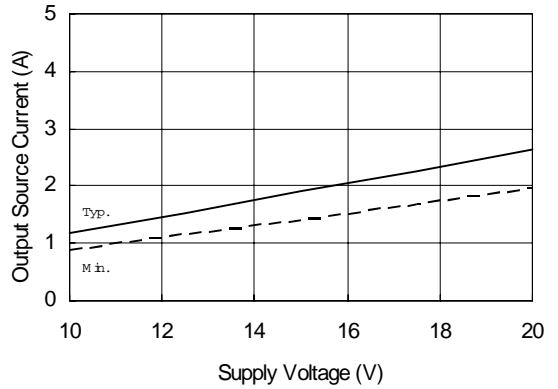

**Figure 19B. Output Source Current vs. Supply Voltage**

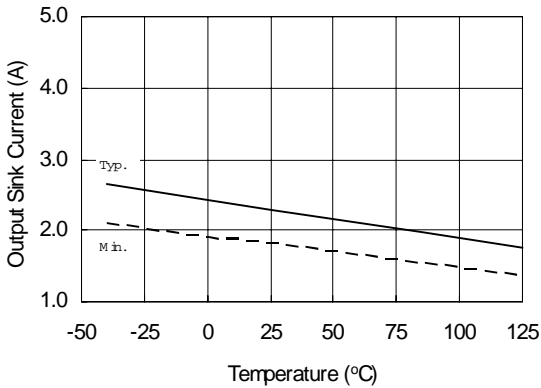

**Figure 20A. Output Sink Current vs. Temperature**

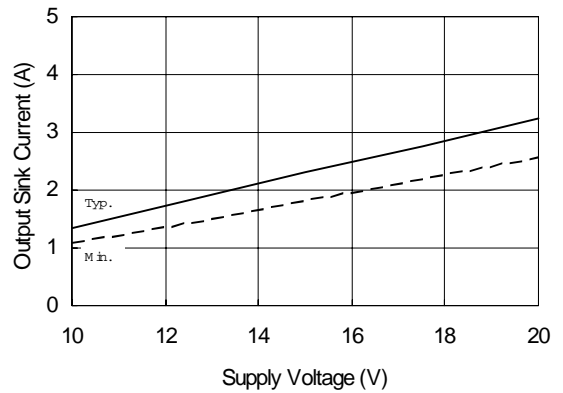

**Figure 20B. Output Sink Current vs. Supply Voltage**

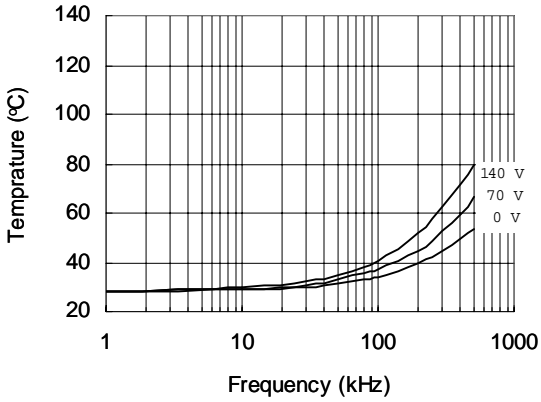

**Figure 21. IRS2181 vs. Frequency (IRFBC20),  
 $R_{gate}=33 \Omega, V_{cc}=15 V$**

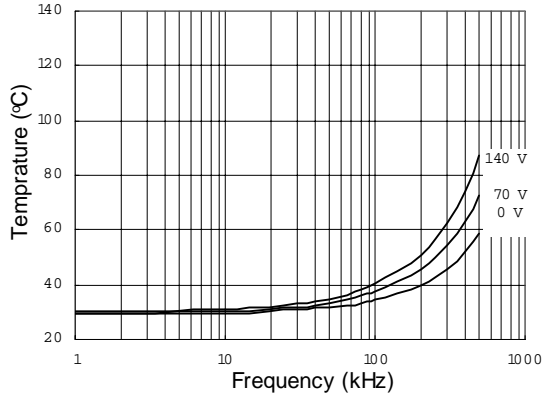

**Figure 22. IRS2181 vs. Frequency (IRFBC30),  
 $R_{gate}=22 \Omega, V_{cc}=15 V$**

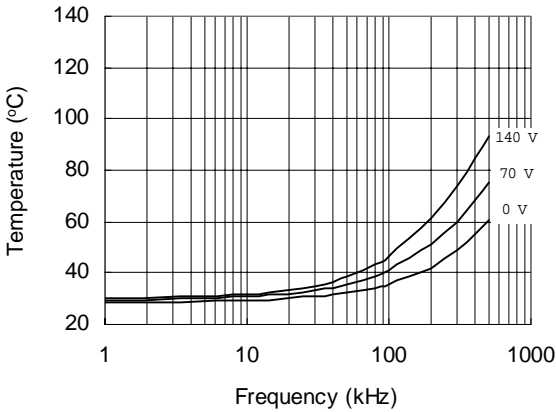

**Figure 23. IRS2181 vs. Frequency (IRFBC40),  
 $R_{gate}=15 \Omega, V_{cc}=15 V$**

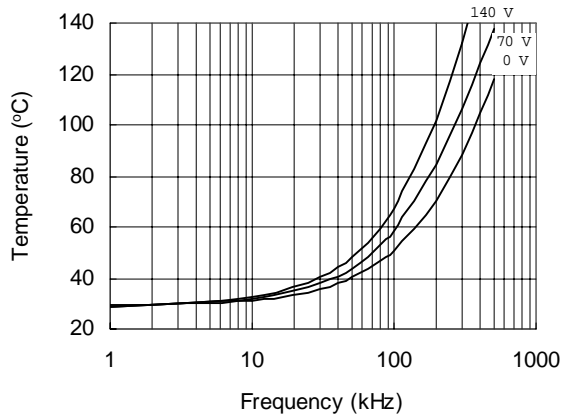

**Figure 24. IRS2181 vs. Frequency (IRFPE50),  
 $R_{gate}=10 \Omega, V_{cc}=15 V$**

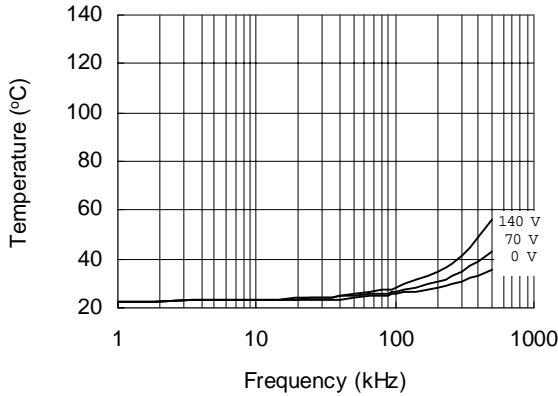

**Figure 25. IRS21814 vs. Frequency (IRFBC20),  
 $R_{gate}=33 \Omega$ ,  $V_{CC}=15 V$**

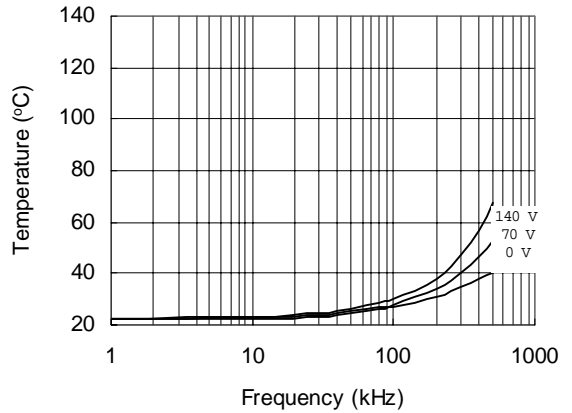

**Figure 26. IRS21814 vs. Frequency (IRFBC30),  
 $R_{gate}=22 \Omega$ ,  $V_{CC}=15 V$**

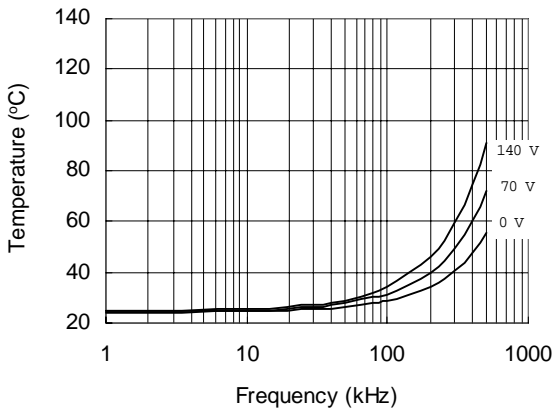

**Figure 27. IRS21814 vs. Frequency (IRFBC40),  
 $R_{gate}=15 \Omega$ ,  $V_{CC}=15 V$**

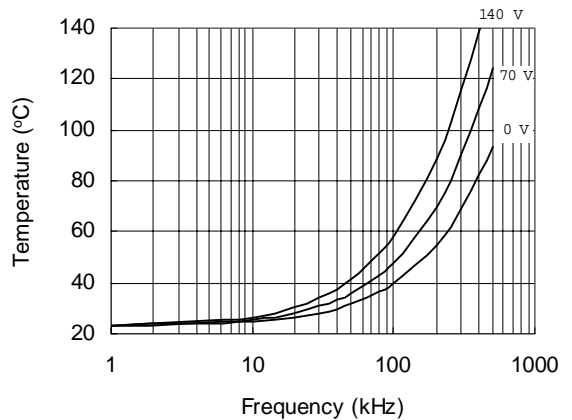

**Figure 28. IRS21814 vs. Frequency (IRFPE50),  
 $R_{gate}=10 \Omega$ ,  $V_{CC}=15 V$**

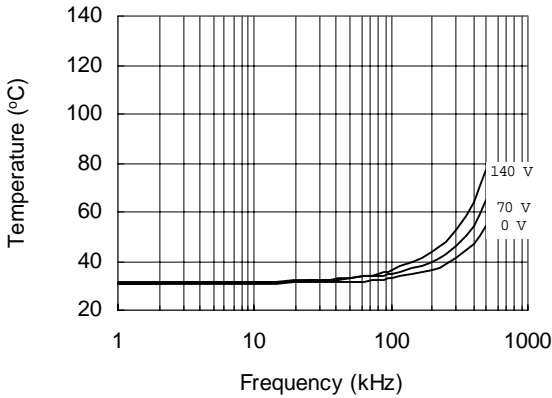

**Figure 29. IRS2181S vs. Frequency (IRFBC20),**  
 $R_{gate}=33 \Omega, V_{CC}=15 V$

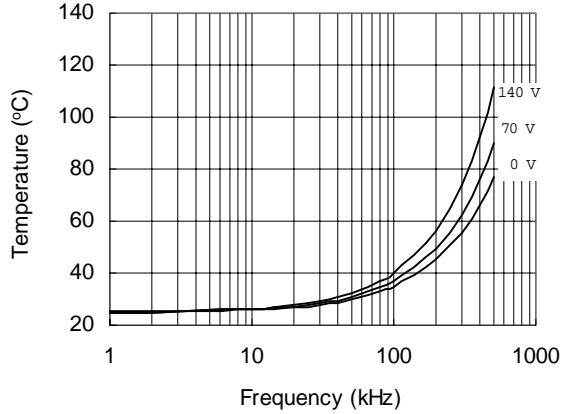

**Figure 30. IRS2181S vs. Frequency (IRFBC30),**  
 $R_{gate}=22 \Omega, V_{CC}=15 V$

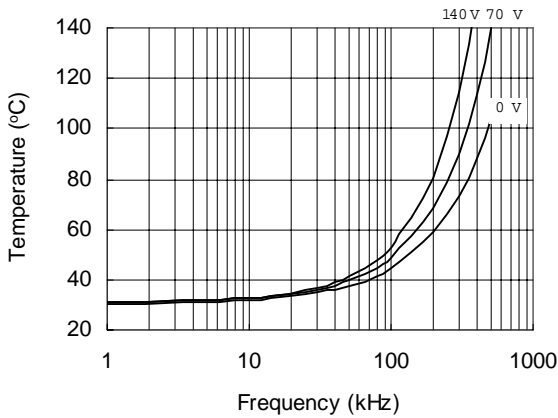

**Figure 31. IRS2181S vs. Frequency (IRFBC40),**  
 $R_{gate}=15 \Omega, V_{CC}=15 V$

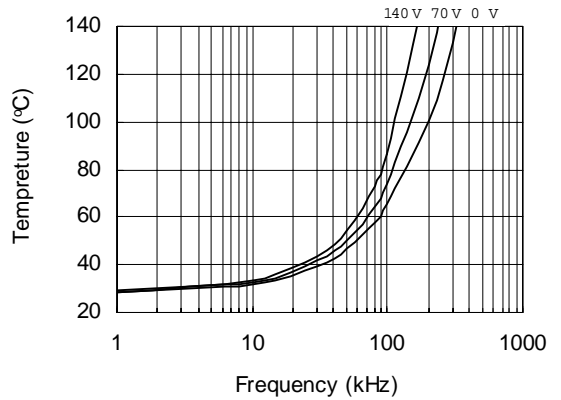

**Figure 32. IRS2181S vs. Frequency (IRFPE50),**  
 $R_{gate}=10 \Omega, V_{CC}=15 V$

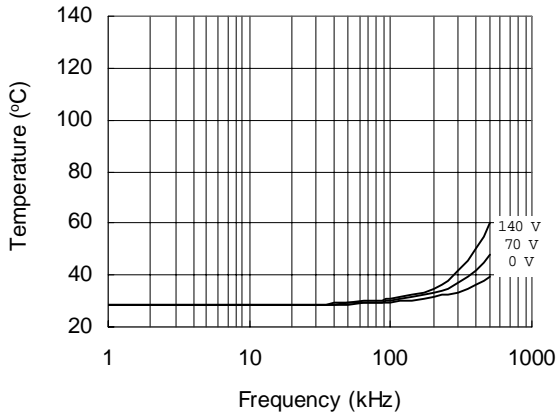

**Figure 33. IRS21814S vs. Frequency (IRFBC20),  
 $R_{gate}=33 \Omega$ ,  $V_{cc}=15 V$**

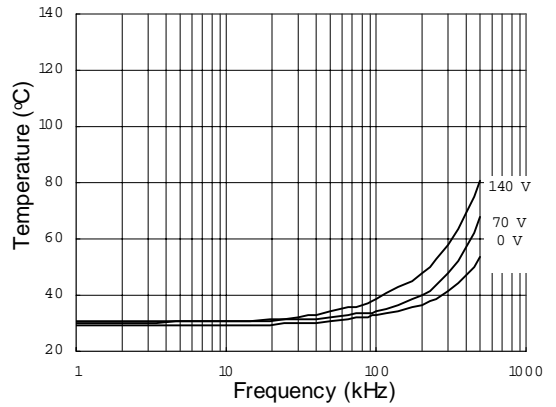

**Figure 34. IRS21814S vs. Frequency (IRFBC30),  
 $R_{gate}=22 \Omega$ ,  $V_{cc}=15 V$**

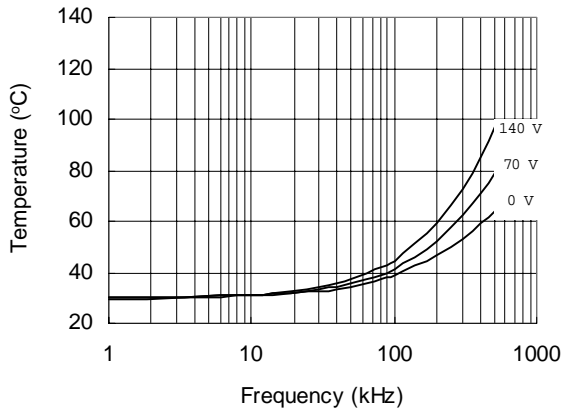

**Figure 35. IRS21814S vs. Frequency (IRFBC40),  
 $R_{gate}=15 \Omega$ ,  $V_{cc}=15 V$**

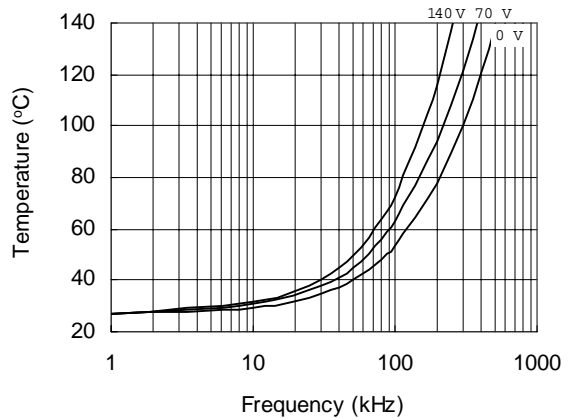

**Figure 36. IRS21814S vs. Frequency (IRFPE50),  
 $R_{gate}=10 \Omega$ ,  $V_{cc}=15 V$**

## Case outlines

**8-Lead PDIP**

01-6014  
01-3003 01 (MS-001AB)

**NOTES:**

1. DIMENSIONING & TOLERANCING PER ANSI Y14.5M-1982.
2. CONTROLLING DIMENSION: INCH.
3. DIMENSIONS ARE SHOWN IN MILLIMETERS [INCHES].
4. OUTLINE CONFORMS TO JEDEC OUTLINE MS-001AB.
- ⑤ MEASURED WITH THE LEADS CONSTRAINED TO BE PERPENDICULAR TO DATUM PLANE C.
- ⑥ DIMENSION DOES NOT INCLUDE MOLD PROTUSIONS. MOLD PROTUSIONS SHALL NOT EXCEED 0.25 [.010].

**8-Lead SOIC**

01-6027  
01-0021 11 (MS-012AA)

DIM	INCHES		MILLIMETERS	
	MIN	MAX	MIN	MAX
A	.0532	.0688	1.35	1.75
A1	.0040	.0098	0.10	0.25
b	.013	.020	0.33	0.51
c	.0075	.0098	0.19	0.25
D	.189	.1968	4.80	5.00
E	.1497	.1574	3.80	4.00
e	.050 BASIC		1.27 BASIC	
e1	.025 BASIC		0.635 BASIC	
H	.2284	.2440	5.80	6.20
K	.0099	.0196	0.25	0.50
L	.016	.050	0.40	1.27
y	0°	8°	0°	8°

**NOTES:**

1. DIMENSIONING & TOLERANCING PER ASME Y14.5M-1994.
2. CONTROLLING DIMENSION: MILLIMETER
3. DIMENSIONS ARE SHOWN IN MILLIMETERS [INCHES].
4. OUTLINE CONFORMS TO JEDEC OUTLINE MS-012AA.
- ⑤ DIMENSION DOES NOT INCLUDE MOLD PROTUSIONS. MOLD PROTUSIONS NOT TO EXCEED 0.15 [.006].
- ⑥ DIMENSION DOES NOT INCLUDE MOLD PROTUSIONS. MOLD PROTUSIONS NOT TO EXCEED 0.25 [.010].
- ⑦ DIMENSION IS THE LENGTH OF LEAD FOR SOLDERING TO A SUBSTRATE.

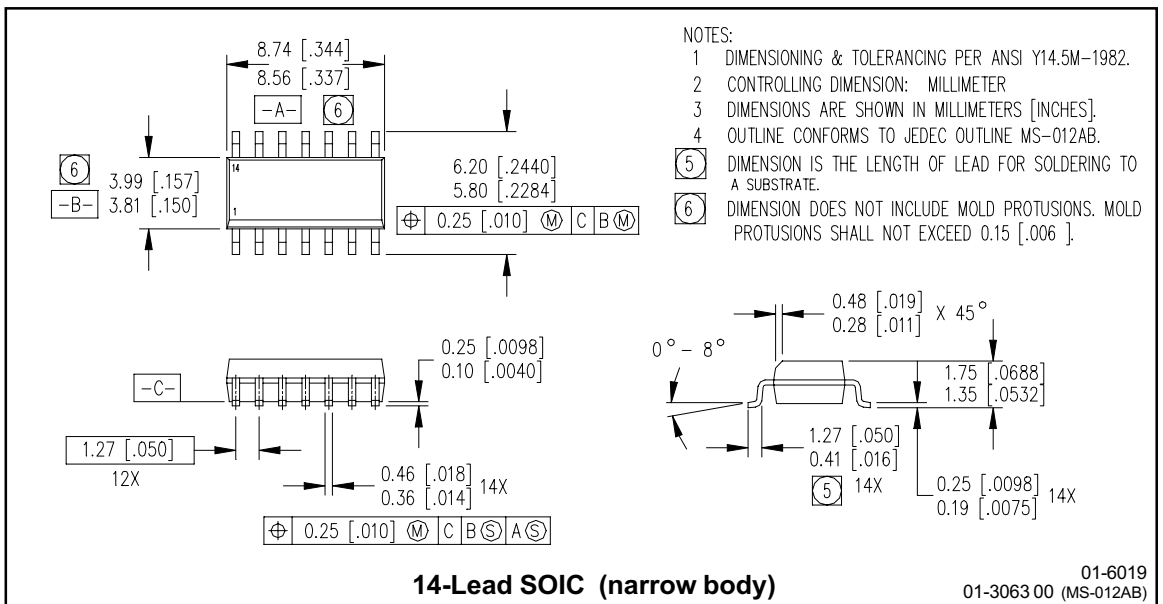
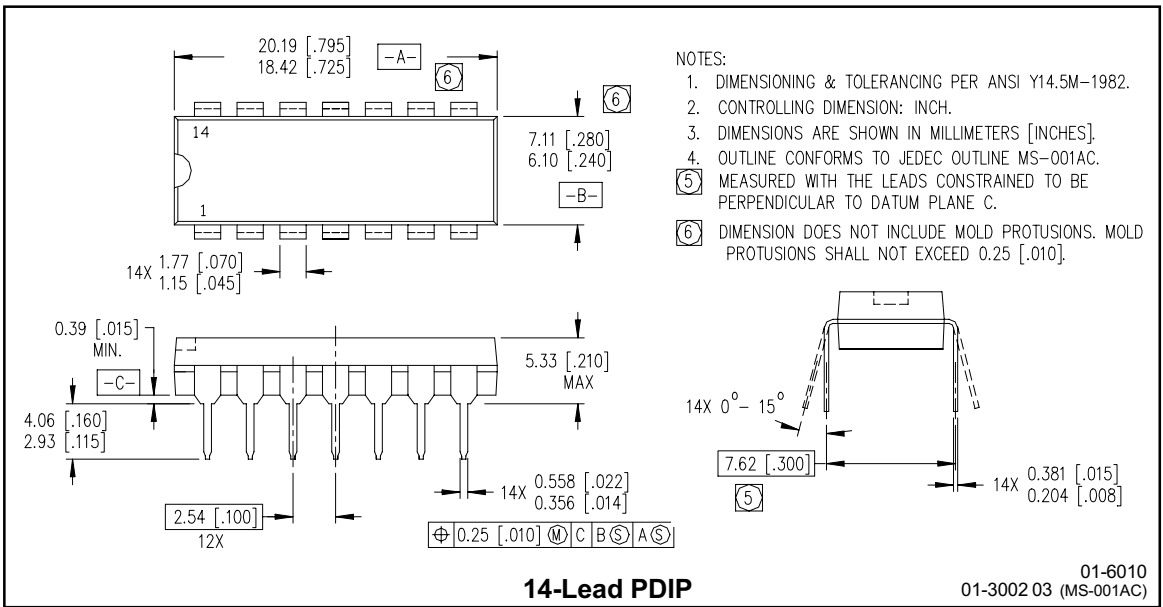

## Tape & Reel 8-lead SOIC

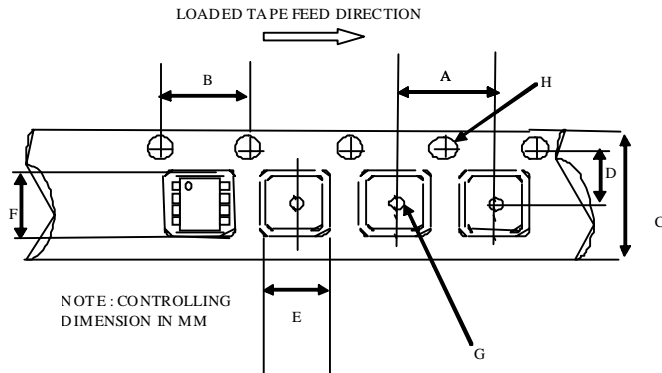

CARRIER TAPE DIMENSION FOR 8SOICN

Code	Metric		Imperial	
	Min	Max	Min	Max
A	7.90	8.10	0.311	0.318
B	3.90	4.10	0.153	0.161
C	11.70	12.30	0.46	0.484
D	5.45	5.55	0.214	0.218
E	6.30	6.50	0.248	0.255
F	5.10	5.30	0.200	0.208
G	1.50	n/a	0.059	n/a
H	1.50	1.60	0.059	0.062

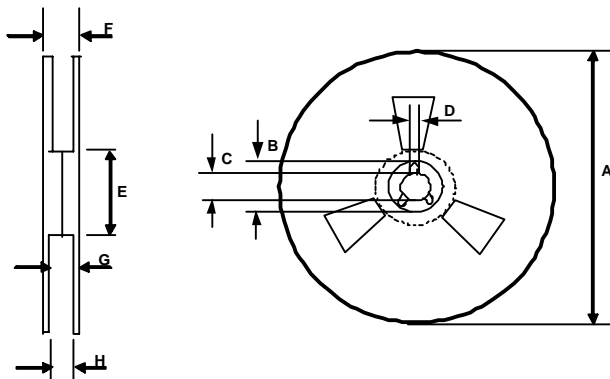

REEL DIMENSIONS FOR 8SOICN

Code	Metric		Imperial	
	Min	Max	Min	Max
A	329.60	330.25	12.976	13.001
B	20.95	21.45	0.824	0.844
C	12.80	13.20	0.503	0.519
D	1.95	2.45	0.767	0.096
E	98.00	102.00	3.858	4.015
F	n/a	18.40	n/a	0.724
G	14.50	17.10	0.570	0.673
H	12.40	14.40	0.488	0.566

## Tape & Reel 14-lead SOIC

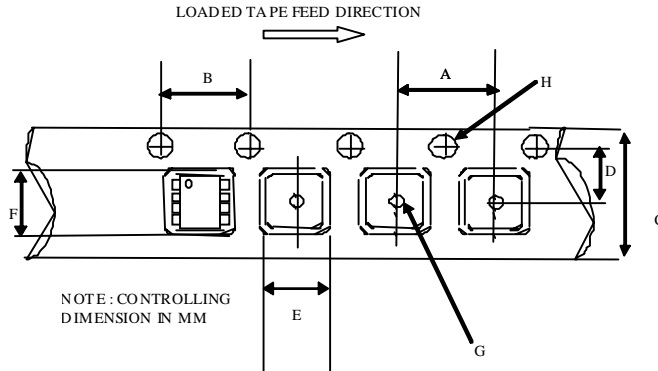

CARRIER TAPE DIMENSION FOR 14SOICN

Code	Metric		Imperial	
	Min	Max	Min	Max
A	7.90	8.10	0.311	0.318
B	3.90	4.10	0.153	0.161
C	15.70	16.30	0.618	0.641
D	7.40	7.60	0.291	0.299
E	6.40	6.60	0.252	0.260
F	9.40	9.60	0.370	0.378
G	1.50	n/a	0.059	n/a
H	1.50	1.60	0.059	0.062

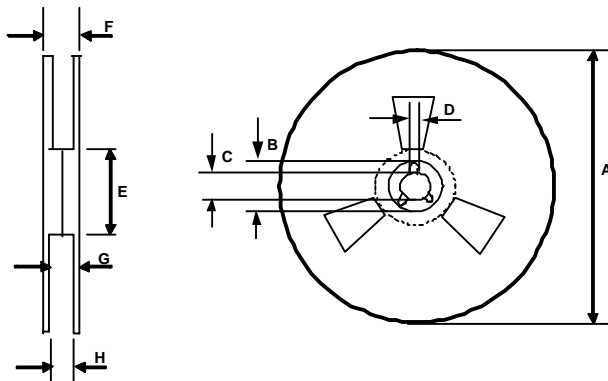

REEL DIMENSIONS FOR 14SOICN

Code	Metric		Imperial	
	Min	Max	Min	Max
A	329.60	330.25	12.976	13.001
B	20.95	21.45	0.824	0.844
C	12.80	13.20	0.503	0.519
D	1.95	2.45	0.767	0.096
E	98.00	102.00	3.858	4.015
F	n/a	22.40	n/a	0.881
G	18.50	21.10	0.728	0.830
H	16.40	18.40	0.645	0.724

## LEADFREE PART MARKING INFORMATION

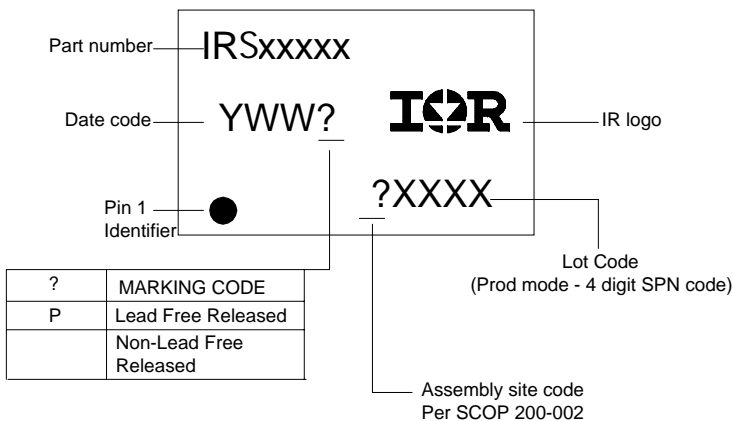

## ORDER INFORMATION

8-Lead PDIP IRS2181PbF  
 8-Lead SOIC IRS2181SPbF  
 8-Lead SOIC Tape & Reel IRS2181STRPbF

14-Lead PDIP IRS21814PbF  
 14-Lead SOIC IRS21814SPbF  
 14-Lead SOIC Tape & Reel IRS21814STRPbF

## Looking for pricing, stock, or lifecycle information?

Click below to explore more details on WIN SOURCE:

-  [View IRS21814SPBF](#) on WIN SOURCE
-  [Infineon Technologies](#) Information

## Optimize Your Supply Chain with WIN SOURCE Solutions

-  Global Sourcing Solution
-  Obsolete Management
-  Cost Control Management
-  Shortage Management
-  Alternative Solution
-  Excess Inventory Management