



**THE DATASHEET OF  
IRS21171STRPBF**



**IRS211(7,71,8)(S)**  
**SINGLE CHANNEL DRIVER**

**IC Features**

- Floating channel designed for bootstrap operation
- Fully operational to +600V
- Tolerant to negative transient voltage, dV/dt immune
- Gate drive supply range from 10 V to 20V
- Undervoltage lockout
- CMOS Schmitt-triggered inputs with pull-down
- Output in phase with input
- RoHS compliant
- IRS2117 and IRS2118 available in PDIP8

**Product Summary**

Topology	Single High Side	
V <sub>OFFSET</sub>	600 V	
V <sub>OUT</sub>	10V-20 V	
I <sub>O+</sub> & I <sub>O-</sub> (typical)	290 mA & 600 mA	
IN voltage threshold	IRS211(7,8)	9.5 V & 6 V
	IRS21171	2.5 V & 0.8 V

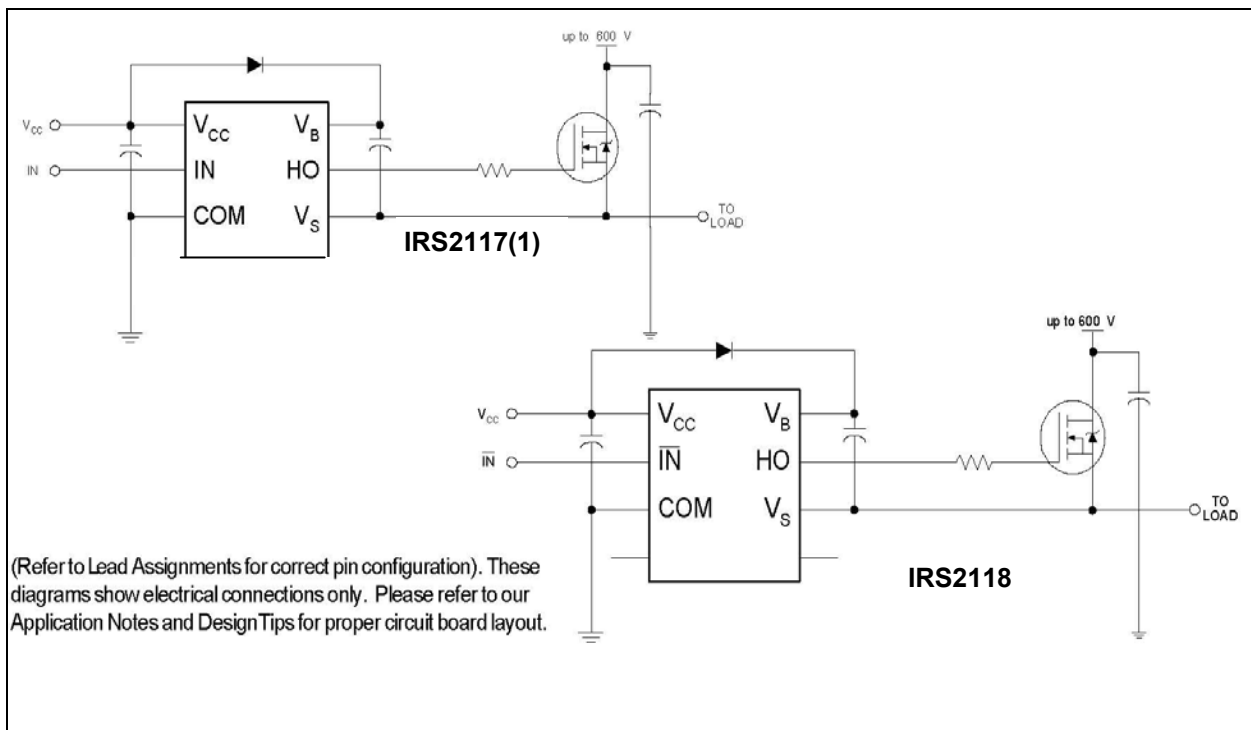
**Package Type**



SOIC8



PDIP8



<b>Table of Contents</b>	<b>Page</b>
Description	3
Qualification Information	4
Absolute Maximum Ratings	5
Recommended Operating Conditions	5
Static Electrical Characteristics	6
Dynamic Electrical Characteristics	6
Functional Block Diagram	7
Input/Output Pin Equivalent Circuit Diagram	8
Lead Definitions	9
Lead Assignments	9
Application Information and Additional Details	10
Parameter Temperature Trends	14
Package Details	23
Tape and Reel Details	24
Part Marking Information	25
Ordering Information	26

## Description

The IRS2117, IRS21171, and IRS2118 are high voltage, high speed power MOSFET and IGBT driver. Proprietary HVIC and latch immune CMOS technologies enable ruggedized mono-lithic construction. The logic input is compatible with standard CMOS outputs. The output driver features a high pulse current buffer stage designed for minimum cross-conduction. The floating channel can be used to drive an N-channel power MOSFET or IGBT in the high-side or low-side configuration which operates up to 600 V.

**Qualification Information<sup>†</sup>**

<b>Qualification Level</b>		Industrial <sup>††</sup> (per JEDEC JESD 47)	
		Comments: This family of ICs has passed JEDEC's Industrial qualification. IR's Consumer qualification level is granted by extension of the higher Industrial level.	
<b>Moisture Sensitivity Level</b>		SOIC8	MSL2 <sup>†††</sup> 260°C (per IPC/JEDEC J-STD-020C)
		PDIP8	Not applicable (non-surface mount package style)
<b>ESD</b>	Machine Model	Class B (per JEDEC standard EIA/JESD22-A115)	
	Human Body Model	Class 3A (per EIA/JEDEC standard JESD22-A114)	
<b>IC Latch-Up Test</b>		Class I, Level A (per JESD78)	
<b>RoHS Compliant</b>		Yes	

† Qualification standards can be found at International Rectifier's web site <http://www.irf.com/>

†† Higher qualification ratings may be available should the user have such requirements. Please contact your International Rectifier sales representative for further information.

††† Higher MSL ratings may be available for the specific package types listed here. Please contact your International Rectifier sales representative for further information.

**Absolute Maximum Ratings**

Absolute maximum ratings indicate sustained limits beyond which damage to the device may occur. All voltage parameters are absolute voltages referenced to COM. The thermal resistance and power dissipation ratings are measured under board mounted and still air conditions.

Symbol	Definition	Min.	Max.	Units	
VB	High-side floating supply voltage	-0.3	625	V	
VS	High-side floating supply offset voltage	VB - 25	VB + 0.3		
VHO	High-side floating output voltage	VS - 0.3	VB + 0.3		
VCC	Logic supply voltage	- 0.3	25		
VIN	Logic input voltage	- 0.3	VCC + 0.3		
dVS/dt	Allowable offset supply voltage transient (fig.2)	---	50	V/ns	
PD	Package power dissipation @ $T_A \leq +25^\circ\text{C}$	8 lead SOIC	---	0.625	W
		8 lead PDIP		1.0	
R $\theta$ JA	Thermal Resistance, junction to Ambient	8 lead SOIC	---	200	$^\circ\text{C}/\text{W}$
		8 lead PDIP		125	
TJ	Junction temperature	---	150	$^\circ\text{C}$	
TS	Storage temperature	-55	150		
TL	Lead Temperature (soldering, 10 seconds)	---	300		

**Recommended Operating Conditions**

The input/output logic timing diagram is shown in Fig. 1. For proper operation the device should be used within the recommended conditions. The VS offset rating is tested with all supplies biased at 15 V differential.

Symbol	Definition	Min.	Max.	Units
VB	High-Side floating supply absolute voltage	VS + 10	VS + 20	V
VS	High-side floating supply offset voltage	†	600	
VST	Transient High side floating supply offset voltage	-50 (††)	600	
VHO	High-side floating output voltage	VS	VB	
VCC	Logic supply voltage	10	20	
VIN	Logic input voltage	0	VCC	
TA	Ambient Temperature	-40	125	$^\circ\text{C}$

† Logic operational for VS of -5 V to +600 V. Logic state held for VS of -5 V to -VBS.

†† Operational for transient negative VS of COM - 50 V with a 50 ns pulse width. Guaranteed by design. Refer to the Application Information section of this datasheet for more details.

**Dynamic Electrical Characteristics**V<sub>BIAS</sub> (V<sub>CC</sub>, V<sub>BS</sub>) = 15 V, C<sub>L</sub> = 1000 pF and T<sub>A</sub> = 25 ° C unless otherwise specified.

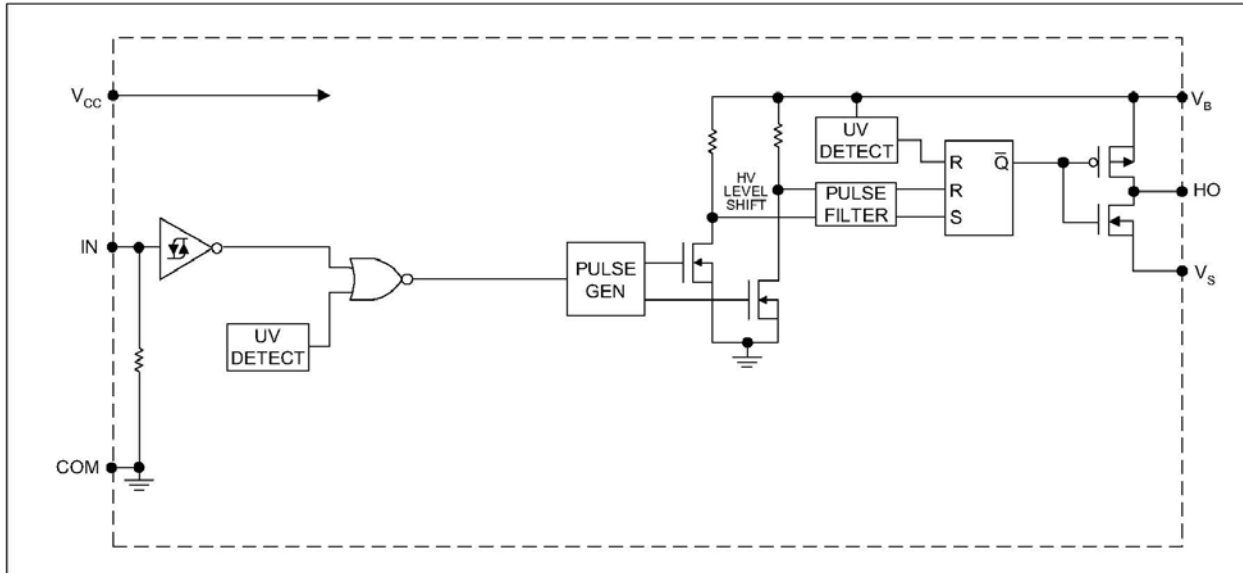
Symbol	Definition	Min.	Typ.	Max.	Units	Test Conditions	
t <sub>on</sub>	Turn-on propagation delay	IRS21171	---	160	230	ns	V <sub>S</sub> = 0V
		IRS211(7,8)	---	125	200		
t <sub>off</sub>	Turn-off propagation delay	IRS21171	---	160	230		V <sub>S</sub> = 600V
		IRS211(7,8)	---	105	180		
t <sub>r</sub>	Turn-on rise time	---	75	130			
t <sub>f</sub>	Turn-off fall time	---	35	65			

**Static Electrical Characteristics**V<sub>BIAS</sub> (V<sub>CC</sub>, V<sub>BS</sub>) = 15 V and T<sub>A</sub> = 25 ° C unless otherwise specified. The V<sub>IN</sub>, V<sub>TH</sub>, and I<sub>IN</sub> parameters are referenced to COM. The V<sub>O</sub> and I<sub>O</sub> parameters are referenced to COM and are applicable to the respective output leads: HO or LO.

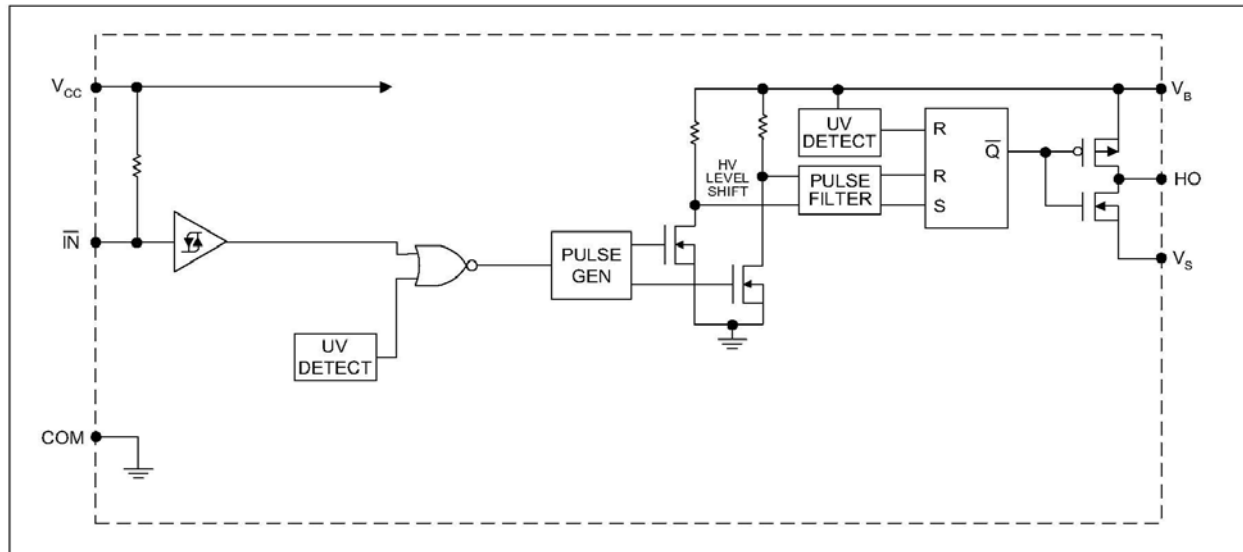
Symbol	Definition	Min	Typ	Max	Units	Test Conditions	
V <sub>IH</sub>	Input voltage –logic “1”	IRS21171	2.5	---	---	V	
		IRS211(7,8)	9.5	---	---		
V <sub>IL</sub>	Input voltage – logic “0”	IRS21171	---	---	0.8		
		IRS211(7,8)			6.0		
V <sub>OH</sub>	High level output voltage, V <sub>BIAS</sub> – V <sub>O</sub>	---	0.05	0.2	I <sub>O</sub> = 2mA		
V <sub>OL</sub>	Low level output voltage, V <sub>O</sub>	---	0.02	0.1			
I <sub>LK</sub>	Offset supply leakage current	---	---	50	μA	V <sub>B</sub> = V <sub>S</sub> = 600V	
I <sub>QBS</sub>	Quiescent V <sub>BS</sub> Supply Current	IRS211(7,8)	---	50		240	V <sub>IN</sub> = 0V or V <sub>CC</sub>
		IRS21171	---	80		150	
I <sub>QCC</sub>	Quiescent V <sub>CC</sub> Supply Current	IRS211(7,8)	---	70		340	
		IRS21171	---	120		240	
I <sub>IN+</sub>	Logic “1” input bias current	IRS2117(1)	---	20		40	
		IRS2118				V <sub>IN</sub> = 0V	
I <sub>IN-</sub>	Logic “0” input bias current	IRS2117(1)	---	---	5.0	V <sub>IN</sub> = V <sub>CC</sub>	
		IRS2118					
V <sub>BSUV+</sub>	V <sub>BS</sub> supply undervoltage positive going	7.6	8.6	9.6	V		
V <sub>BSUV-</sub>	V <sub>BS</sub> supply undervoltage negative going	7.2	8.2	9.2			
V <sub>CCUV+</sub>	V <sub>CC</sub> supply undervoltage positive going	7.6	8.6	9.6			
V <sub>CCUV-</sub>	V <sub>CC</sub> supply undervoltage negative going	7.2	8.2	9.2			
I <sub>O+</sub>	Output high short circuit pulsed current	200	290	---	mA	V <sub>O</sub> = 0V V <sub>IN</sub> Logic “1” PW ≤ 10 μs	
I <sub>O-</sub>	Output low short circuit pulsed current	420	600	---		V <sub>O</sub> = 15V V <sub>IN</sub> Logic “0” PW ≤ 10 μs	

## Functional Block Diagram

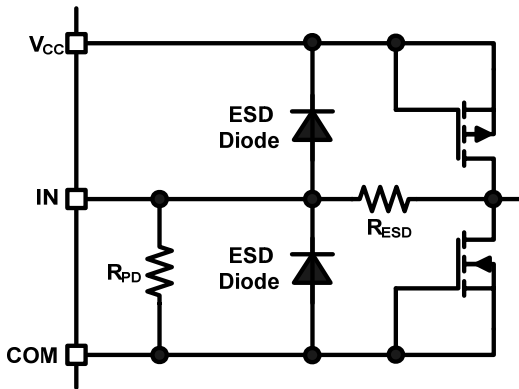
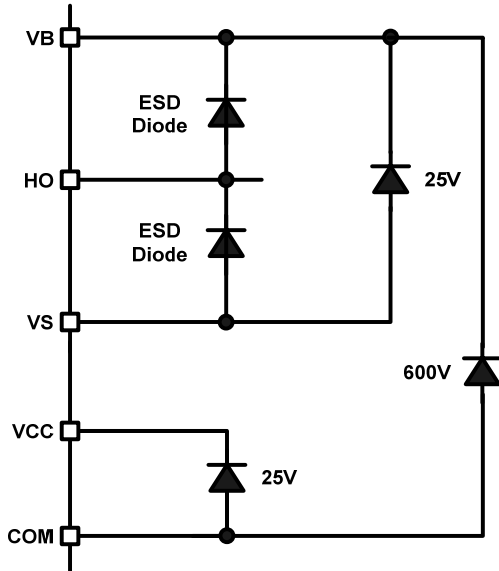
### IRS2117(1)



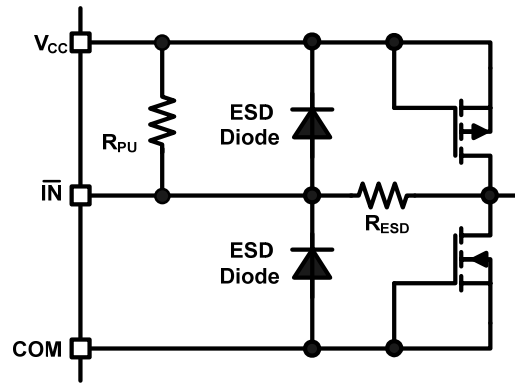
### IRS2118



**I/O Pin Equivalent Circuit Diagrams: IRS211(7,71,8)**



IRS2117(1)

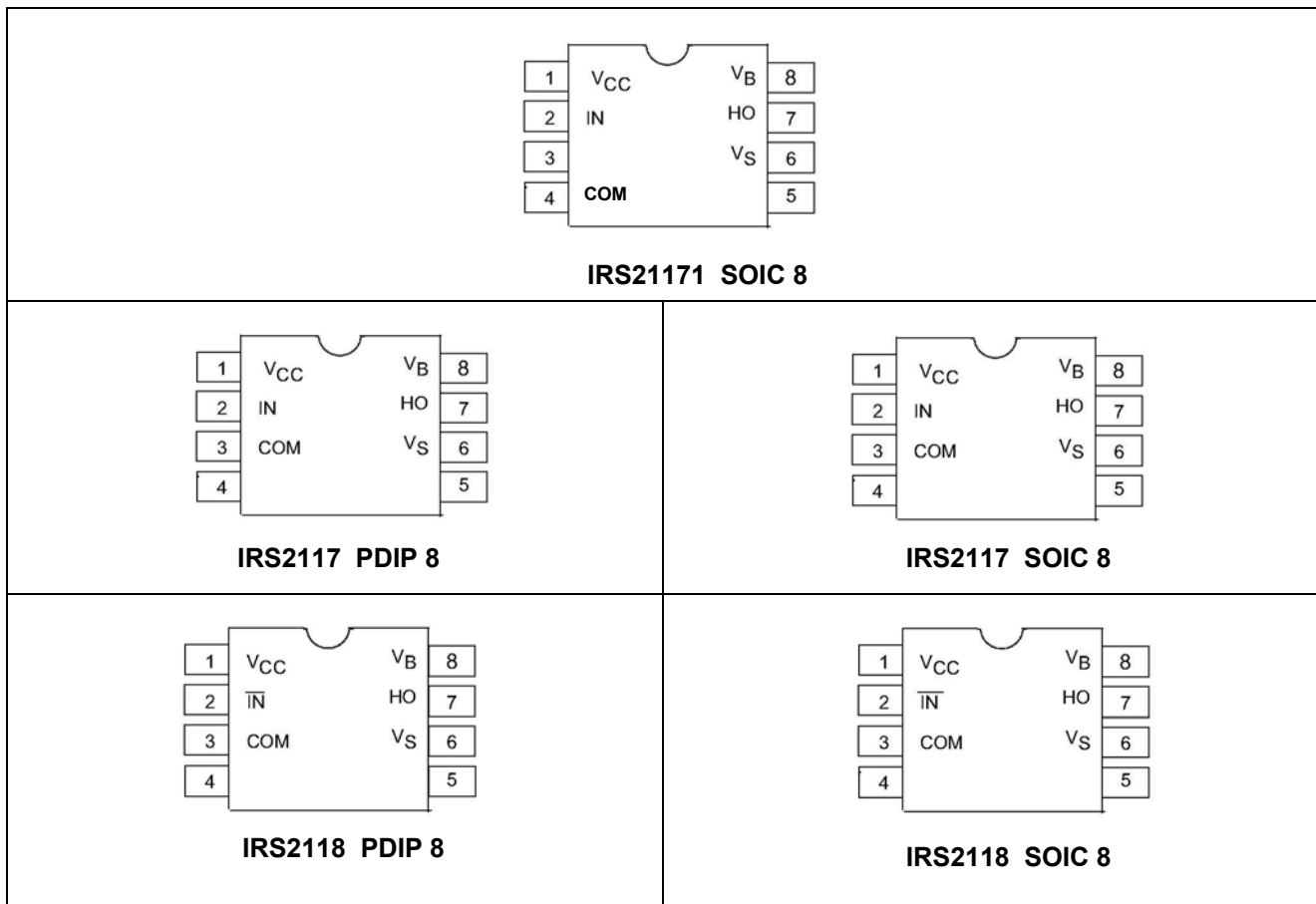


IRS2118

## Lead Definitions

Pin #	Symbol	Description
1	VCC	Logic and gate drive supply
2	IN	IRS2117(1) Logic input for gate driver output (HO), in phase with HO
	$\overline{\text{IN}}$	IRS2118 Logic input for gate driver output (HO), out of phase with HO
3	NC	IRS21171 No Connect
	COM	IRS2117 / IRS2118 Logic ground
4	NC	IRS2117 / IRS2118 No Connect
	COM	IRS21171 Logic ground
5	NC	No Connect
6	V <sub>S</sub>	High-side floating supply return
7	HO	High-side gate drive output
8	V <sub>B</sub>	High-side floating supply

## Lead Assignments





## Tolerant to Negative $V_s$ Transients

A common problem in today's high-power switching converters is the transient response of the switch node's voltage as the power switches transition on and off quickly while carrying a large current. A typical half bridge circuit is shown in Figure 5; here we define the power switches and diodes of the inverter.

If the high-side switch (e.g., Q1 in Figures 6 and 7) switches off, while the current is flowing to a load, a current commutation occurs from high-side switch (Q1) to the diode (D2) in parallel with the low-side switch of the inverter. At the same instance, the voltage node  $V_s$  swings from the positive DC bus voltage to the negative DC bus voltage.

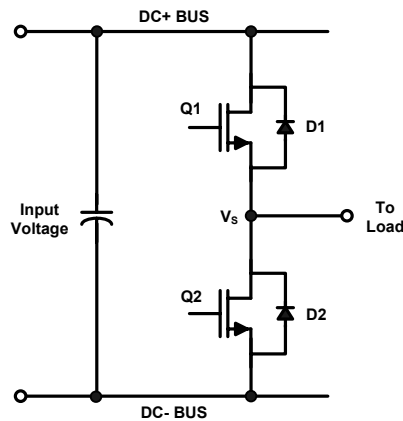


Figure 5: Half Bridge Circuit

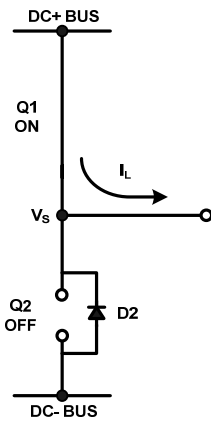


Figure 6: Q1 conducting

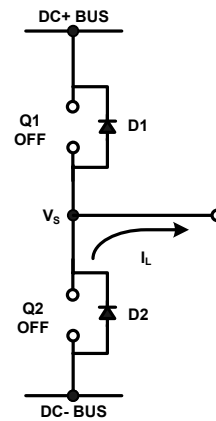


Figure 7: D2 conducting

Also when the current flows from the load back to the inverter (see Figures 8 and 9), and Q2 switches on, the current commutation occurs from D1 to Q2. At the same instance, the voltage node  $V_s$  swings from the positive DC bus voltage to the negative DC bus voltage.

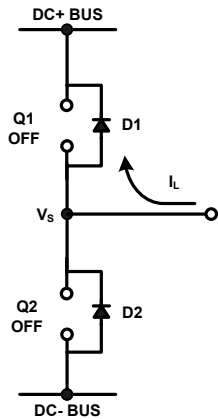


Figure 8: D1 conducting

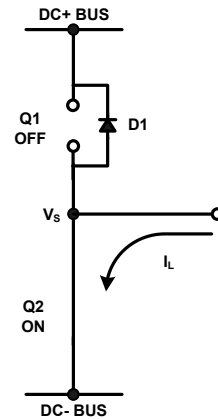


Figure 9: Q2 conducting

However, in a real inverter circuit, the  $V_S$  voltage swing does not stop at the level of the negative DC bus, rather it swings below the level of the negative DC bus. This undershoot voltage is called “negative  $V_S$  transient”.

The circuit shown in Figure 10 depicts a half bridge circuit with parasitic elements shown; Figures 11 and 12 show a simplified illustration of the commutation of the current between Q1 and D2. The parasitic inductances in the power circuit from the die bonding to the PCB tracks are lumped together in  $L_D$  and  $L_S$  for each switch. When the high-side switch is on,  $V_S$  is below the DC+ voltage by the voltage drops associated with the power switch and the parasitic elements of the circuit. When the high-side power switch turns off, the load current can momentarily flow in the low-side freewheeling diode due to the inductive load connected to  $V_S$  (the load is not shown in these figures). This current flows from the DC- bus (which is connected to the COM pin of the HVIC) to the load and a negative voltage between  $V_S$  and the DC- Bus is induced (i.e., the COM pin of the HVIC is at a higher potential than the  $V_S$  pin).

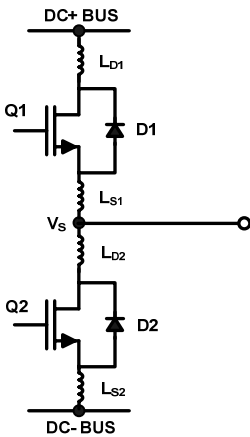


Figure 10: Parasitic Elements

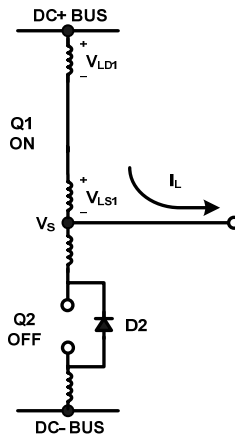


Figure 11:  $V_S$  positive

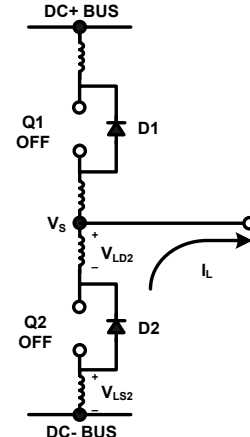
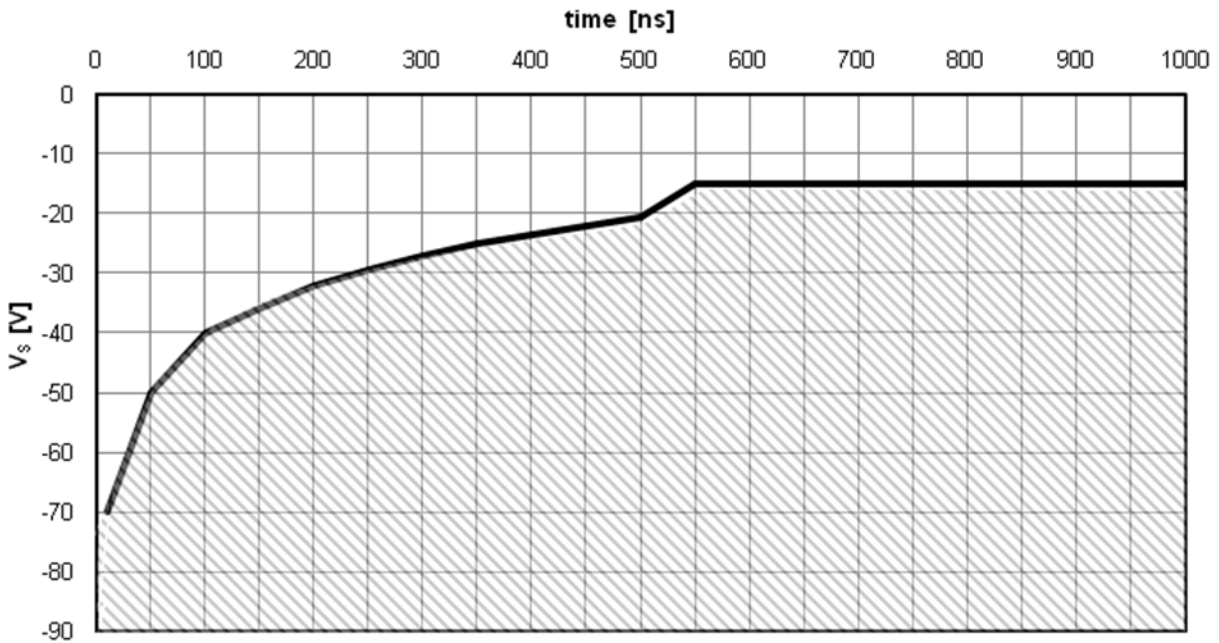


Figure 12:  $V_S$  negative

In a typical power circuit,  $dV/dt$  is typically designed to be in the range of 1-5 V/ns. The negative  $V_S$  transient voltage can exceed this range during some events such as short circuit and over-current shutdown, when  $di/dt$  is greater than in normal operation.

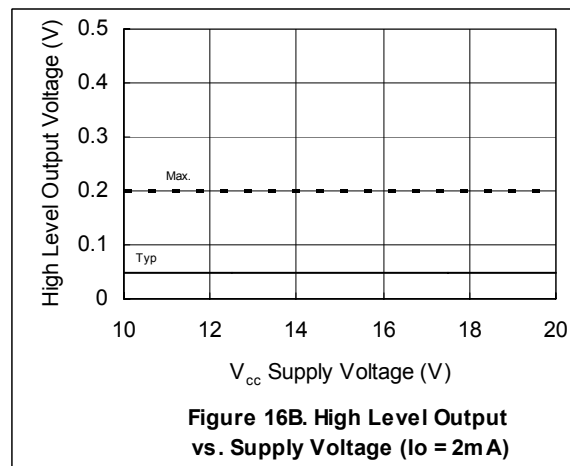
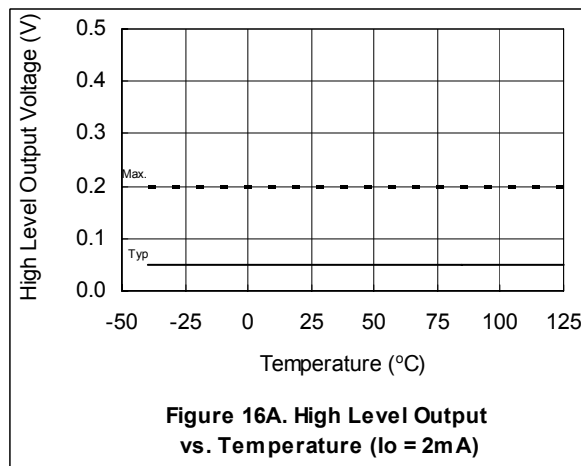
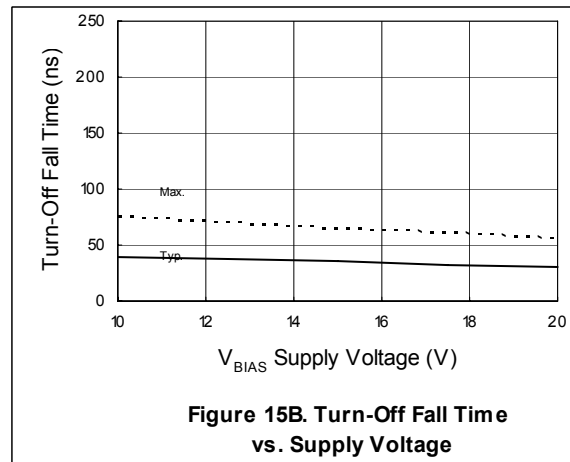
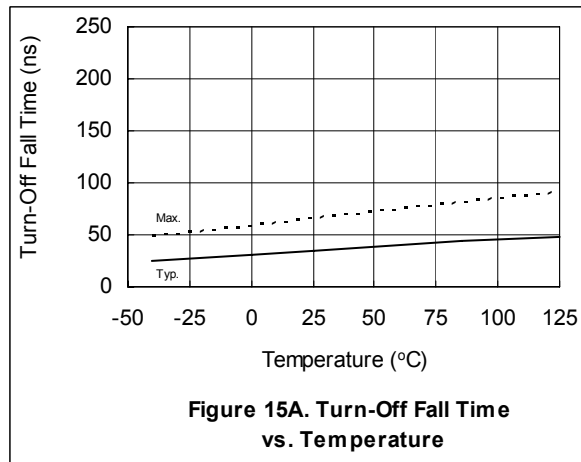
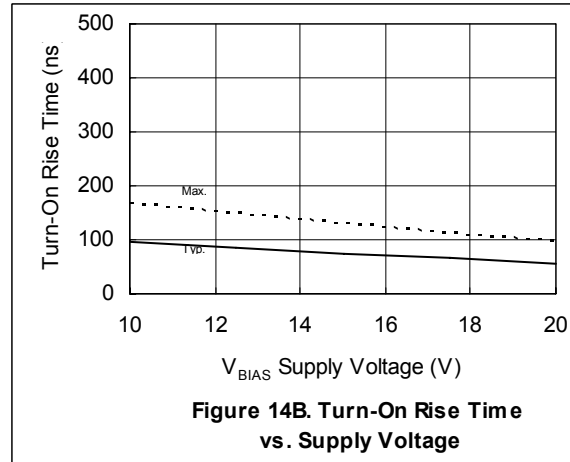
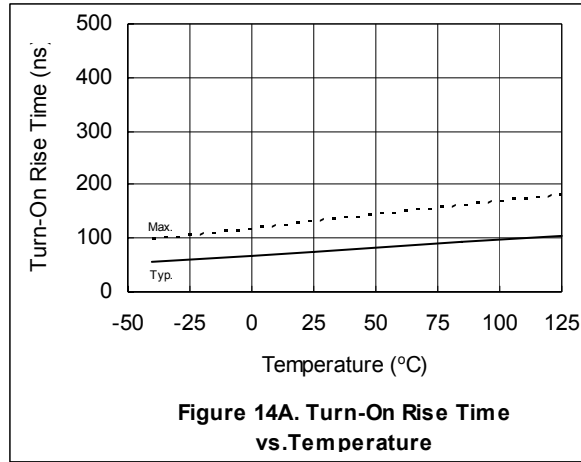
International Rectifier’s HVICs have been designed for the robustness required in many of today’s demanding applications. An indication of the IRS211(7,71,8)’s robustness can be seen in Figure 13, where there is represented the IRS211(7,71,8) Safe Operating Area at  $V_{BS}=15V$  based on repetitive negative  $V_S$  spikes. A negative  $V_S$  transient voltage falling in the grey area (outside SOA) may lead to IC permanent damage; viceversa unwanted functional anomalies or permanent damage to the IC do not appear if negative  $V_S$  transients fall inside SOA.

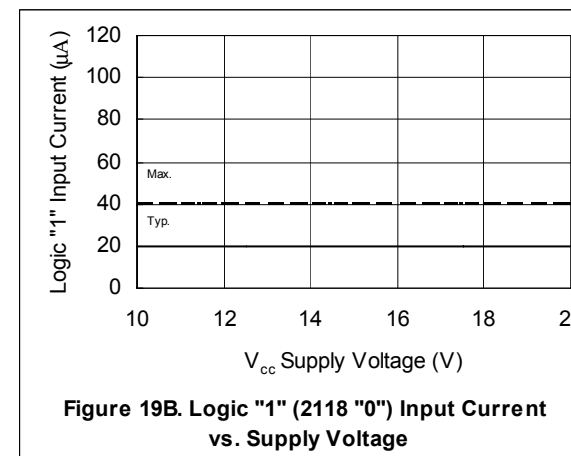
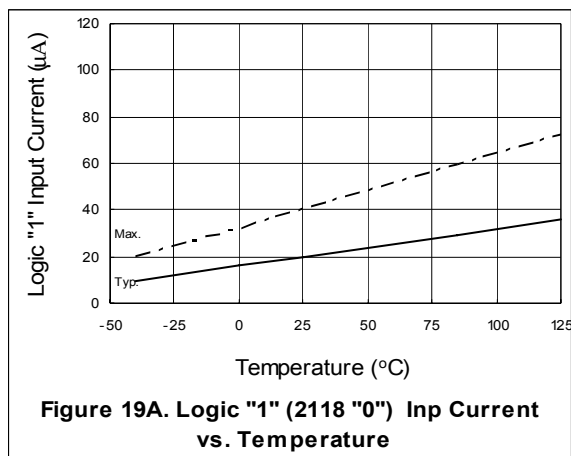
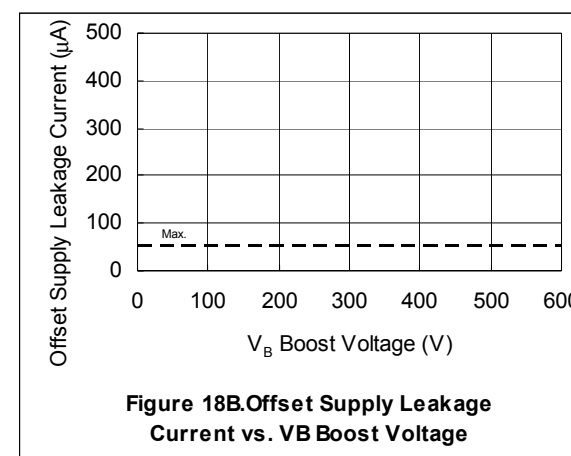
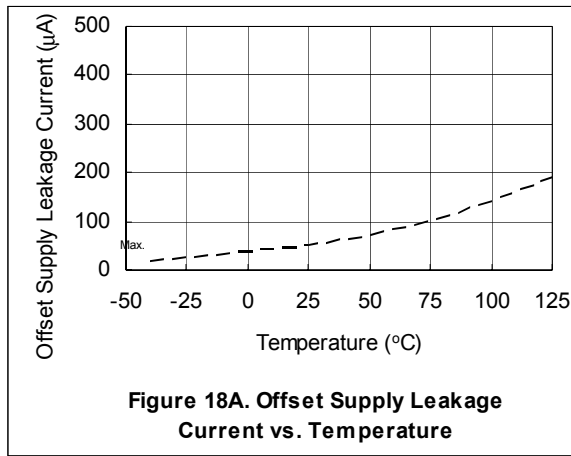
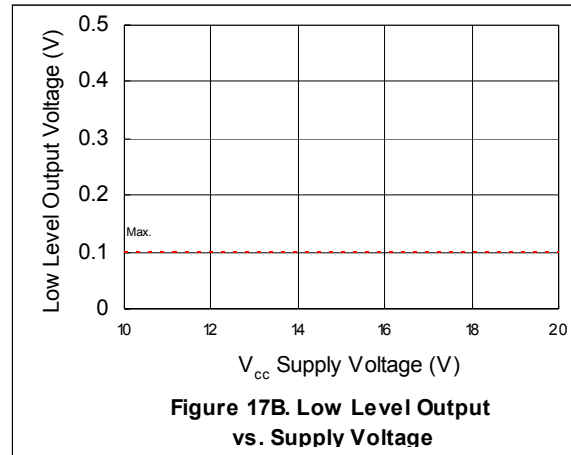
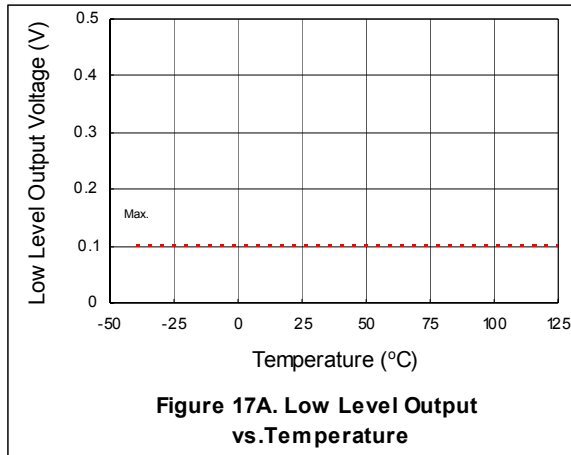


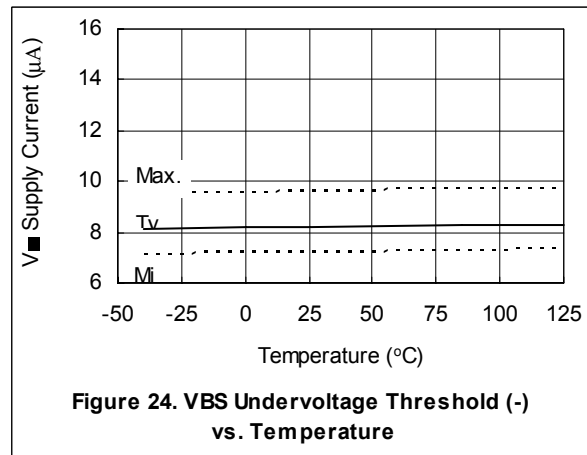
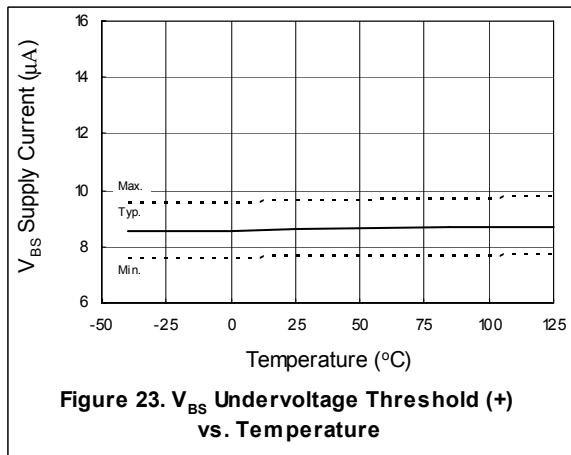
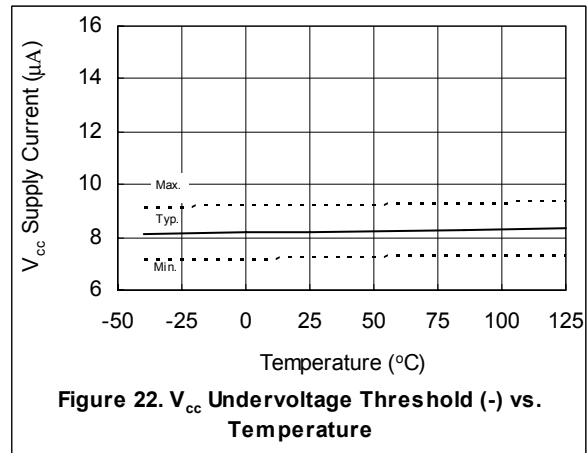
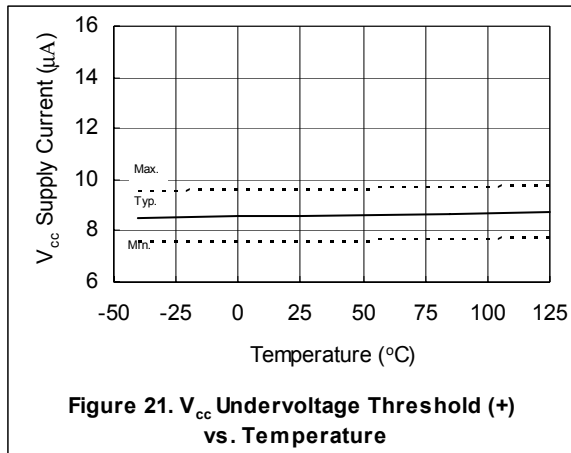
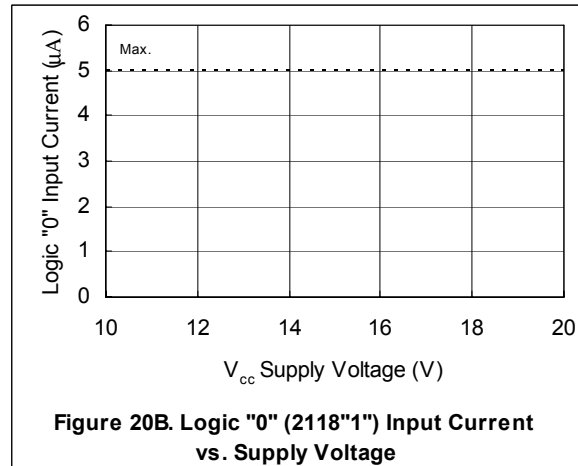
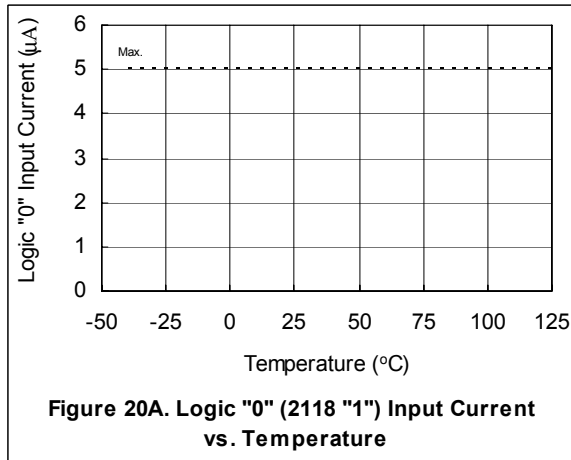
**Figure 13: Negative  $V_s$  transient SOA for IRS211(7,71,8) @  $V_{BS}=15V$**

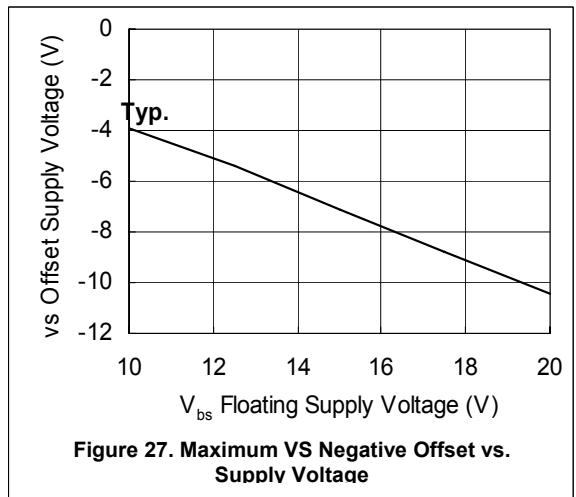
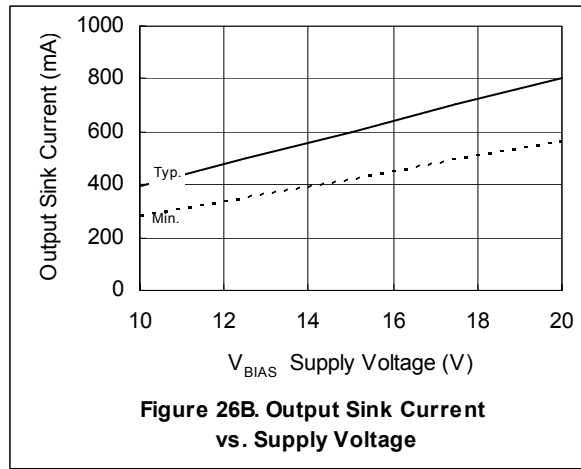
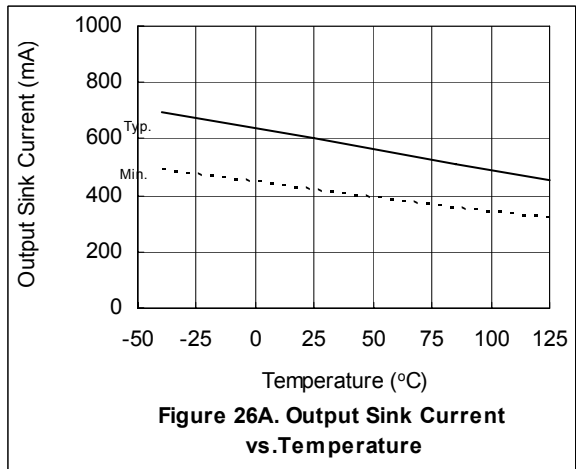
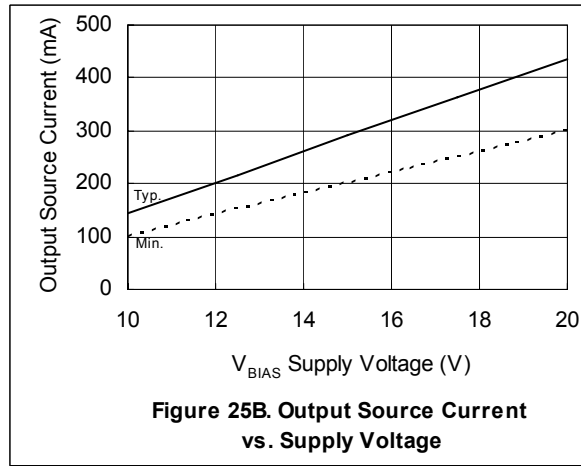
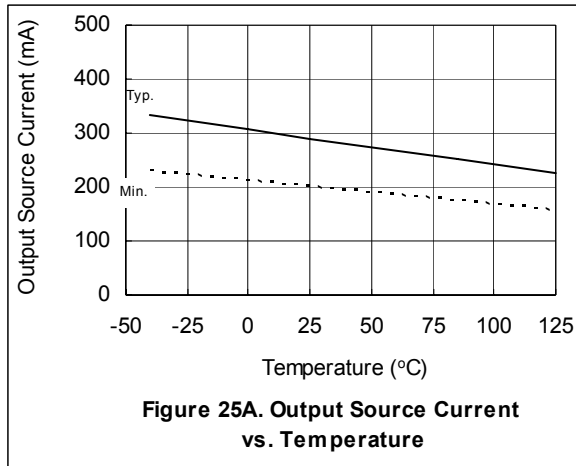
Even though the IRS211(7,71,8) has shown the ability to handle these large negative  $V_s$  transient conditions, it is highly recommended that the circuit designer always limit the negative  $V_s$  transients as much as possible by careful PCB layout and component use.

## Parameter Temperature Trends - 211(7,71,8)

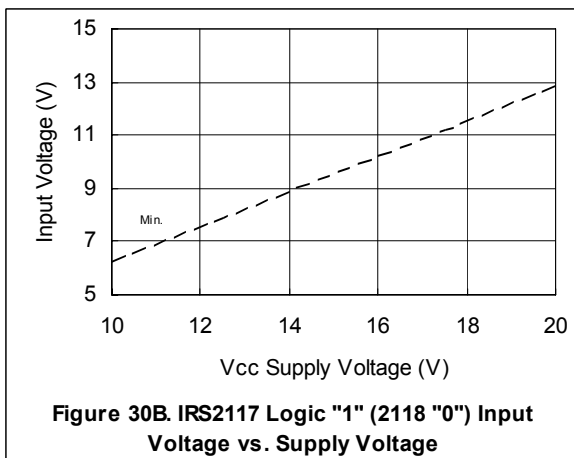
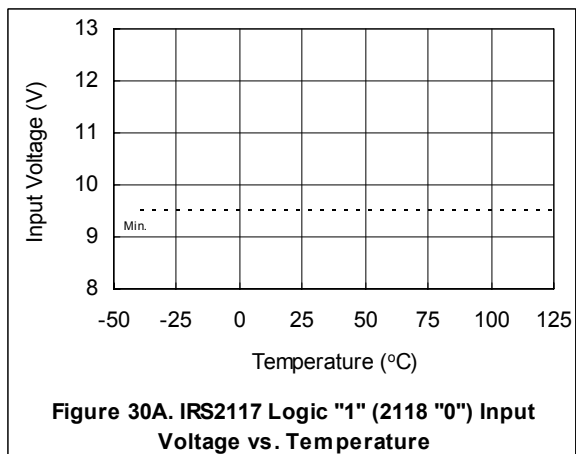
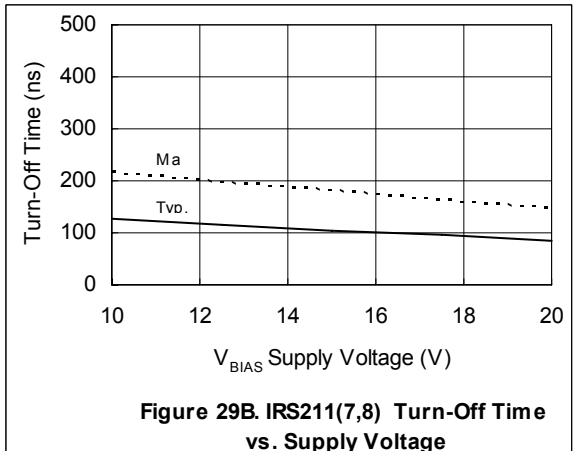
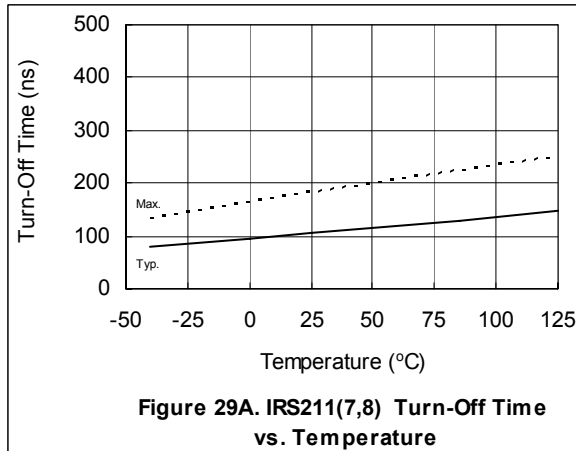
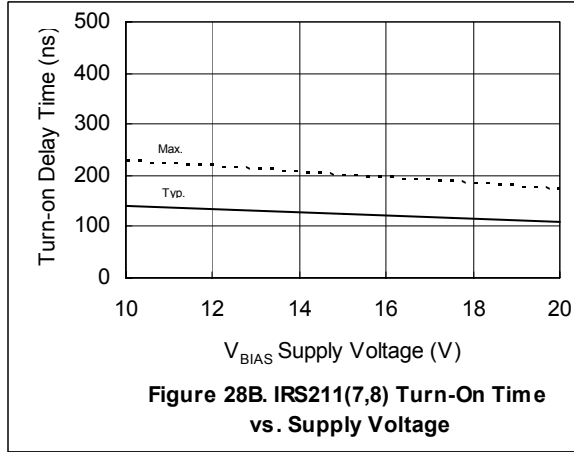
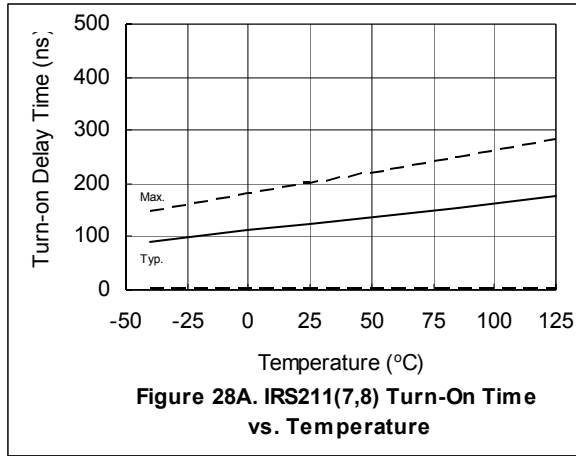




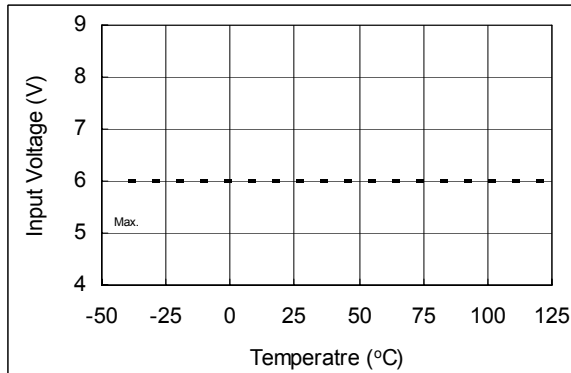




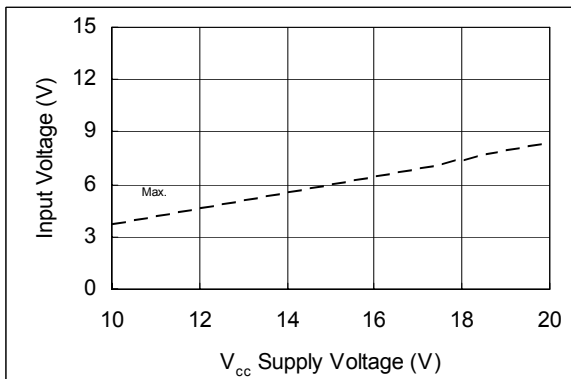
## Parameter Temperature Trends - 211(7,8)



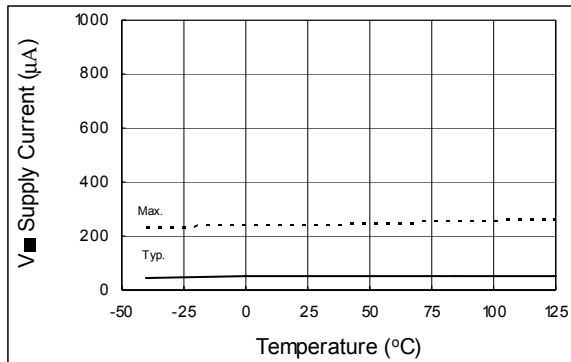
# IRS211(7,71,8)(S)



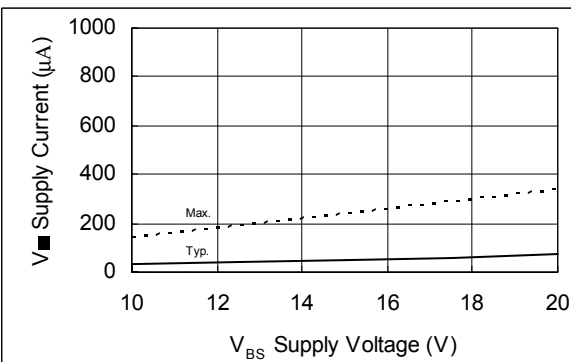
**Figure 31A. IRS2117 Logic "0" (2118 "1") Input Voltage vs. Temperature**



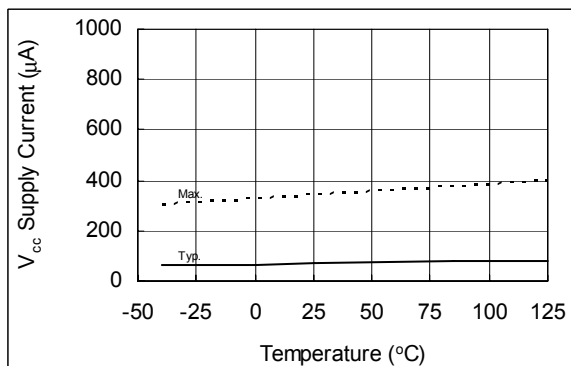
**Figure 31B. IRS2117 Logic "0" (2118 "1") Input Voltage vs. Supply Voltage**



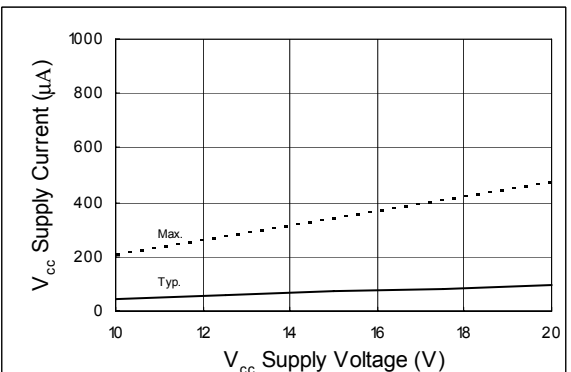
**Figure 32A. 211(7,8) V<sub>BS</sub> Supply Current vs. Temperature**



**Figure 32B. 211(7,8) V<sub>BS</sub> Supply Current**

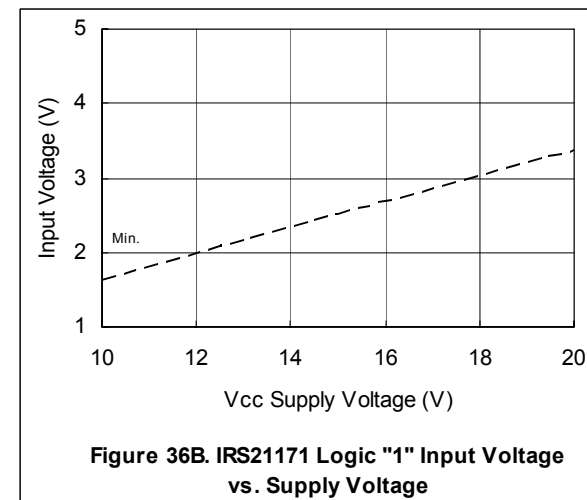
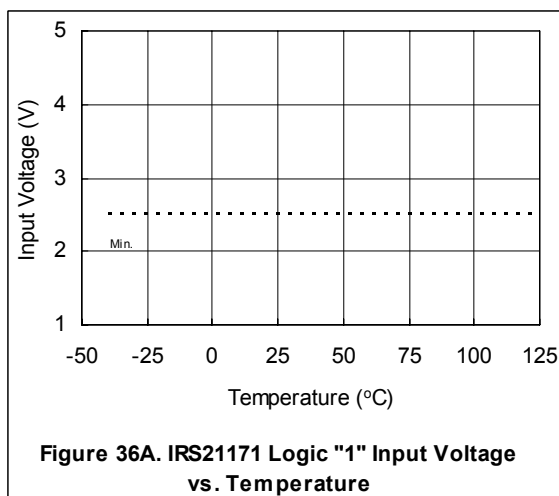
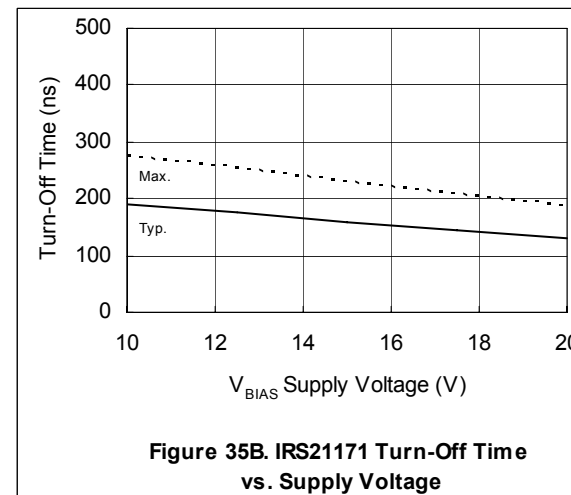
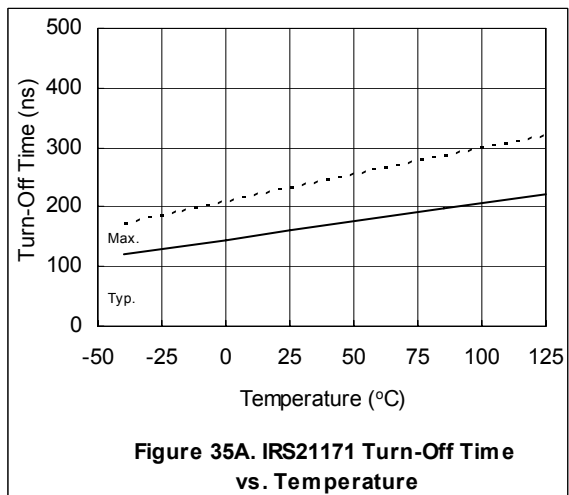
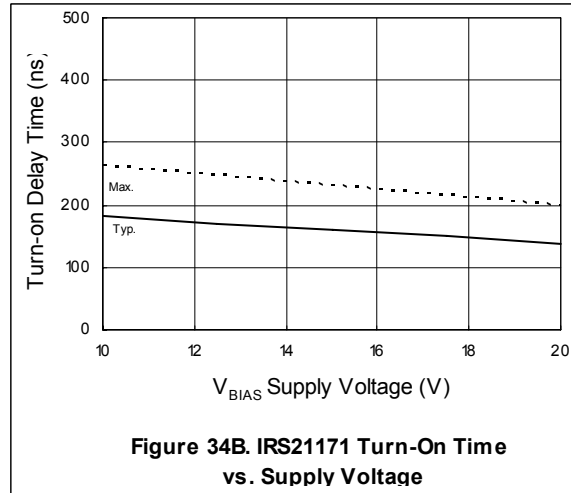
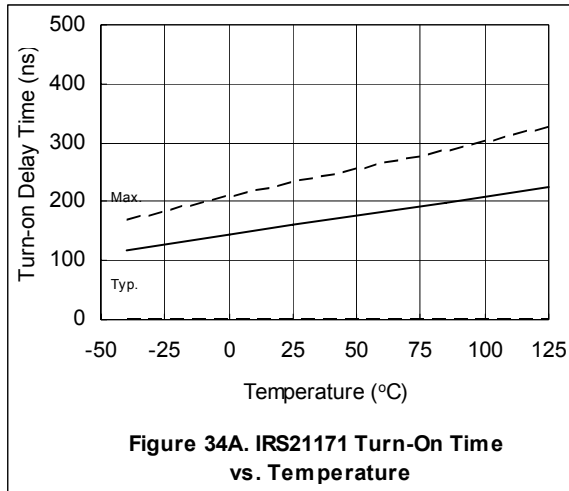


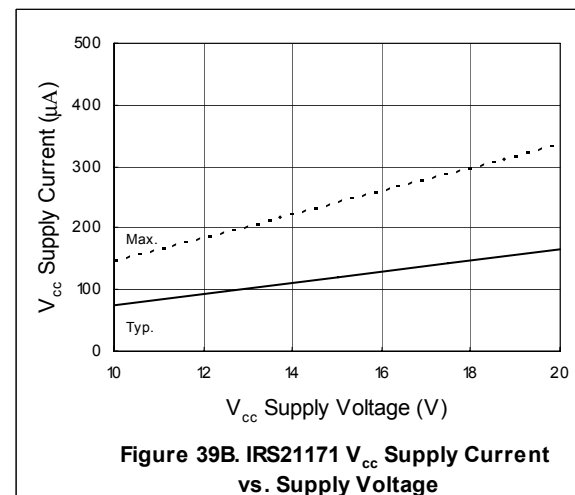
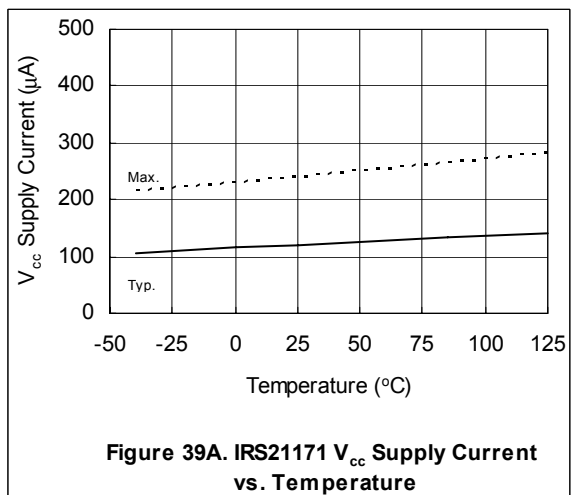
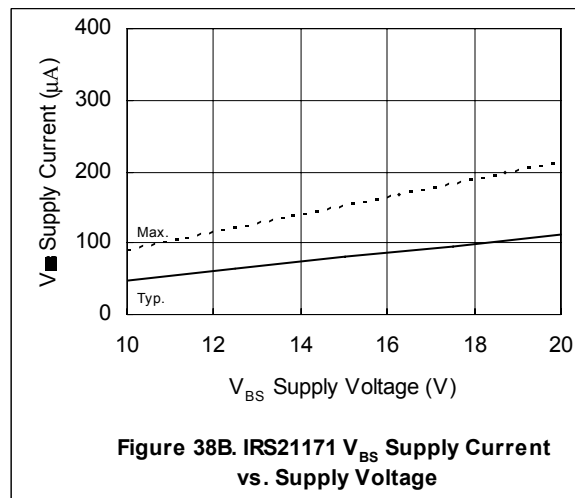
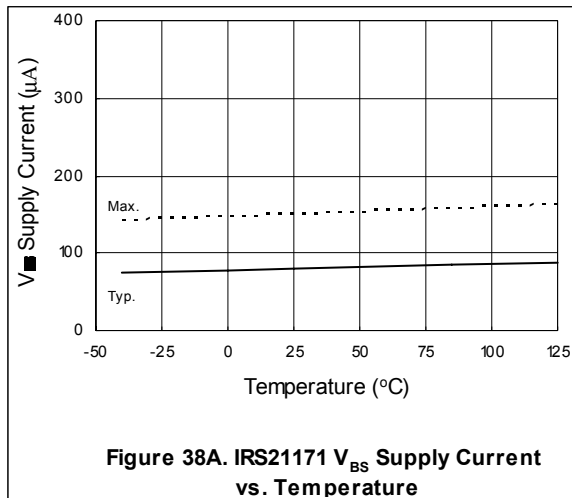
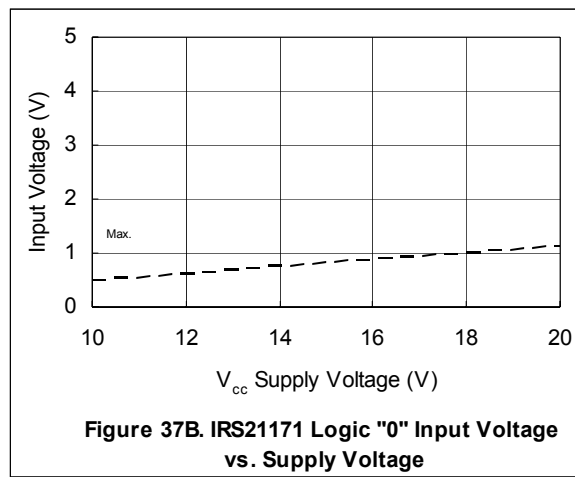
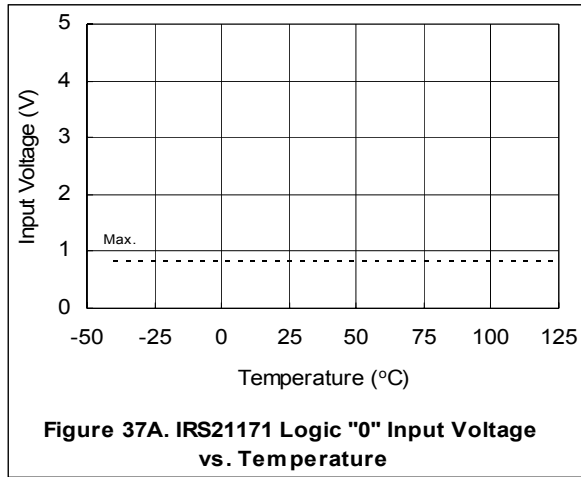
**Figure 33A. 211(7,8) V<sub>cc</sub> Supply Current vs. Temperature**



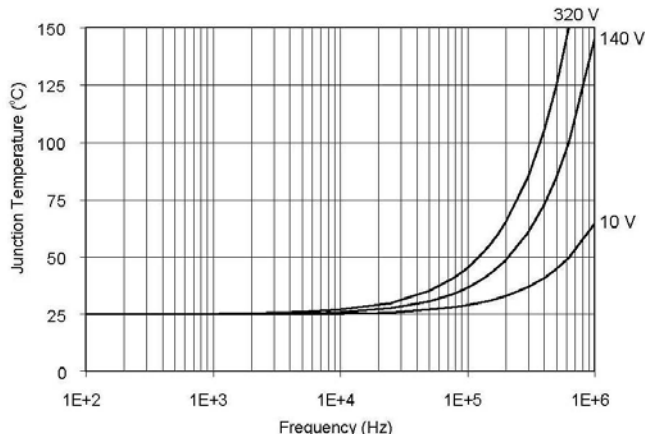
**Figure 33B. 211(7,8) V<sub>cc</sub> Supply Current vs. Supply Voltage**

## Parameter Temperature Trends - 21171

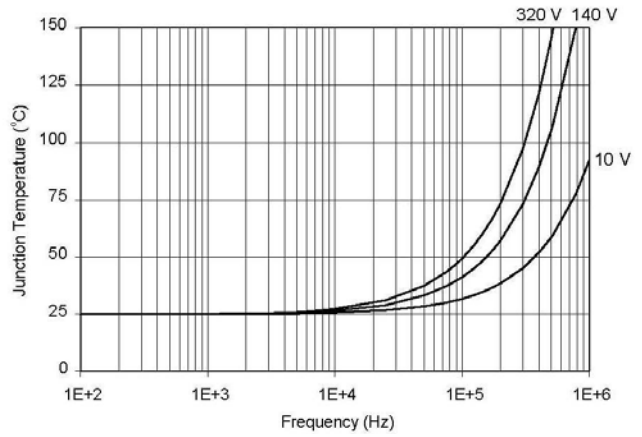




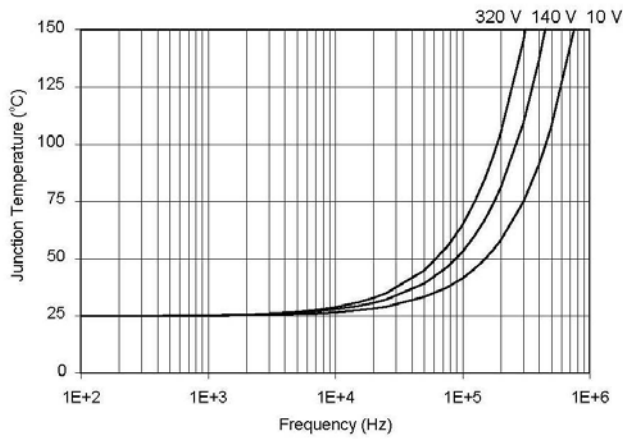
# IRS211(7,71,8)(S)



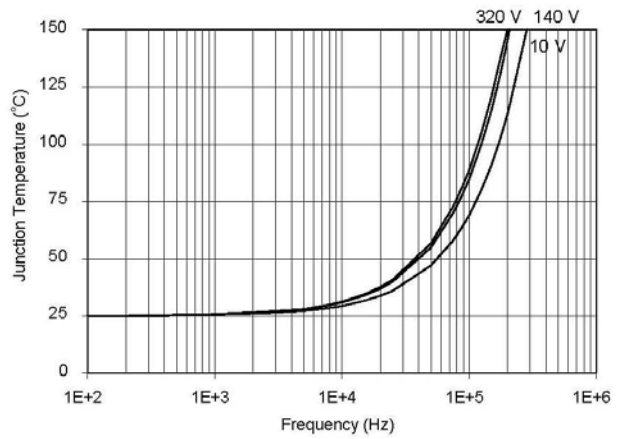
**Figure 40. IRS2117/IRS2118  $T_J$  vs. Frequency (IRFBC20)**  
 $R_{GATE}=33\Omega$ ,  $V_{CC}=15V$



**Figure 41. IRS2117/IRS2118  $T_J$  vs. Frequency (IRFBC30)**  
 $R_{GATE}=22\Omega$ ,  $V_{CC}=15V$

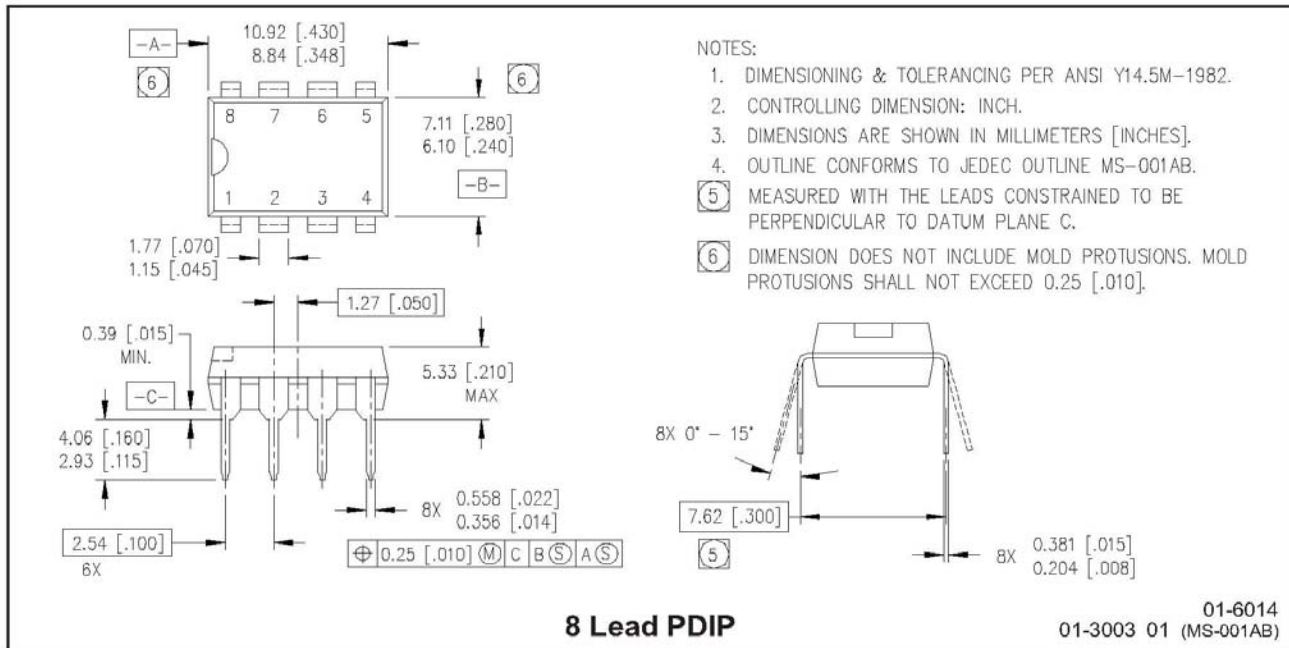


**Figure 42. IRS2117/IRS2118  $T_J$  vs. Frequency (IRFBC40)**  
 $R_{GATE}=15\Omega$ ,  $V_{CC}=15V$

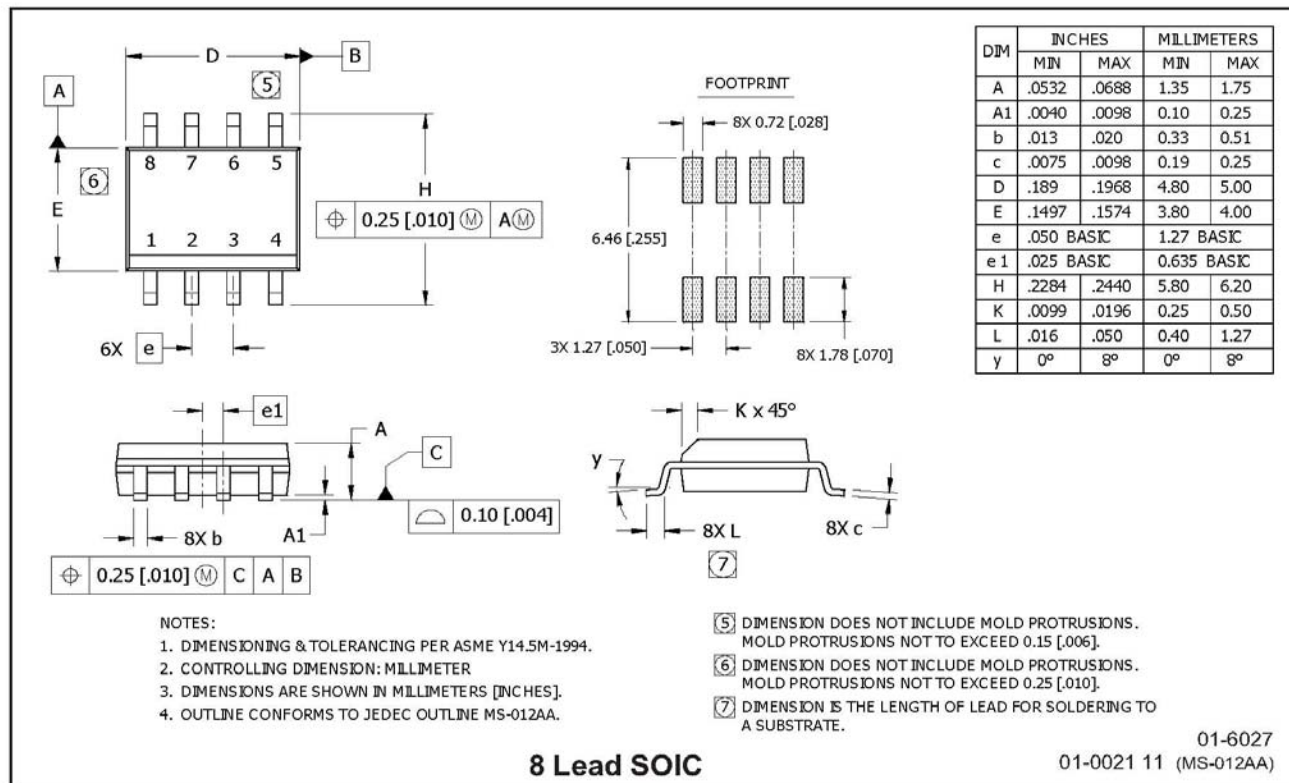


**Figure 43. IRS2117/IRS2118  $T_J$  vs. Frequency (IRFPE50)**  
 $R_{GATE}=10\Omega$ ,  $V_{CC}=15V$

## Package Details

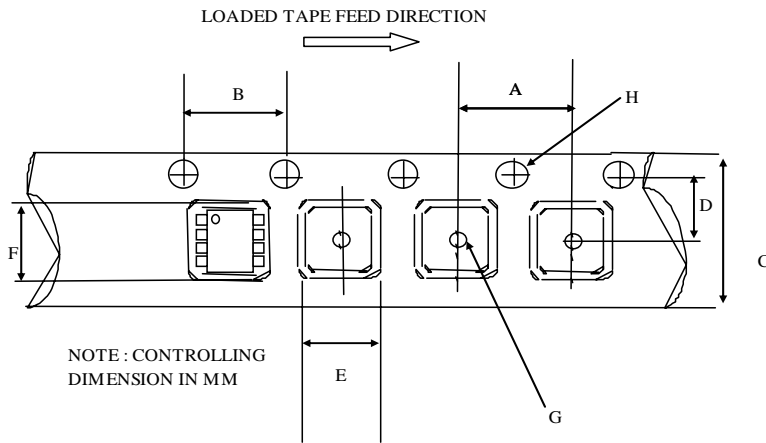


**8 Lead PDIP**



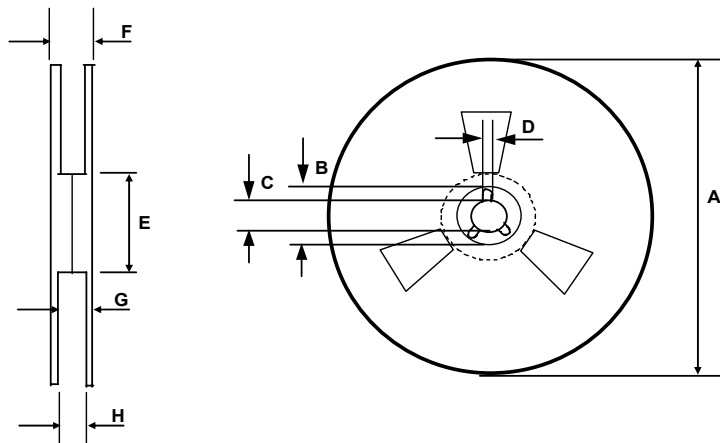
**8 Lead SOIC**

**Package Details: SOIC8N, Tape and Reel**



CARRIER TAPE DIMENSION FOR 8SOICN

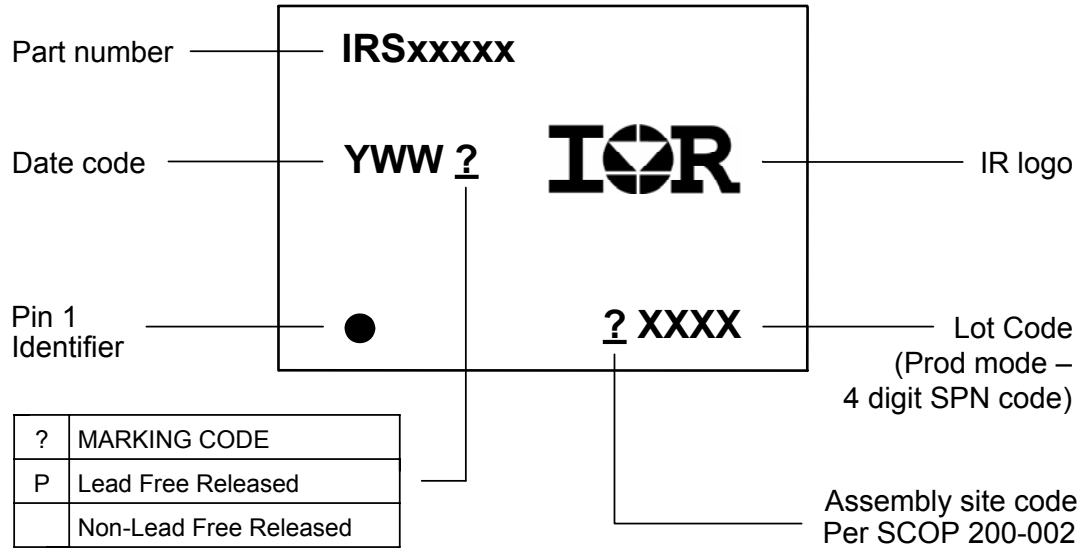
Code	Metric		Imperial	
	Min	Max	Min	Max
A	7.90	8.10	0.311	0.318
B	3.90	4.10	0.153	0.161
C	11.70	12.30	0.46	0.484
D	5.45	5.55	0.214	0.218
E	6.30	6.50	0.248	0.255
F	5.10	5.30	0.200	0.208
G	1.50	n/a	0.059	n/a
H	1.50	1.60	0.059	0.062



REEL DIMENSIONS FOR 8SOICN

Code	Metric		Imperial	
	Min	Max	Min	Max
A	329.60	330.25	12.976	13.001
B	20.95	21.45	0.824	0.844
C	12.80	13.20	0.503	0.519
D	1.95	2.45	0.767	0.096
E	98.00	102.00	3.858	4.015
F	n/a	18.40	n/a	0.724
G	14.50	17.10	0.570	0.673
H	12.40	14.40	0.488	0.566

**Part Marking Information**



**Ordering Information**

Base Part Number	Package Type	Standard Pack		Complete Part Number
		Form	Quantity	
IRS2117	SOIC8N	Tube/Bulk	95	IRS2117SPBF
		Tape and Reel	2500	IRS2117STRPBF
	PDIP8	Tube/Bulk	50	IRS2117PBF
IRS21171	SOIC8N	Tube/Bulk	95	IRS21171SPBF
		Tape and Reel	2500	IRS21171STRPBF
IRS2118	SOIC8N	Tube/Bulk	95	IRS2118SPBF
		Tape and Reel	2500	IRS2118STRPBF
	PDIP8	Tube/Bulk	50	IRS2118PBF

The information provided in this document is believed to be accurate and reliable. However, International Rectifier assumes no responsibility for the consequences of the use of this information. International Rectifier assumes no responsibility for any infringement of patents or of other rights of third parties which may result from the use of this information. No license is granted by implication or otherwise under any patent or patent rights of International Rectifier. The specifications mentioned in this document are subject to change without notice. This document supersedes and replaces all information previously supplied.

For technical support, please contact IR's Technical Assistance Center  
<http://www.irf.com/technical-info/>

WORLD HEADQUARTERS:  
 233 Kansas St., El Segundo, California 90245  
 Tel: (310) 252-7105

## Looking for pricing, stock, or lifecycle information?

Click below to explore more details on WIN SOURCE:

 [View IRS21171STRPBF on WIN SOURCE](#)

 [Infineon Technologies](#) Information

## Optimize Your Supply Chain with WIN SOURCE Solutions

-  Global Sourcing Solution
-  Obsolete Management
-  Cost Control Management
-  Shortage Management
-  Alternative Solution
-  Excess Inventory Management