

# ANN-MB series

Multi-band, high precision GNSS antennas

Data Sheet



## Abstract

This technical data sheet describes the ANN-MB Multi-band (L1, L2/E5b/B2I) active GNSS antennas that support GPS, GLONASS, Galileo, and BeiDou. The antennas provide a fast and easy solution for high precision applications with an excellent price to performance ratio. The antenna variants offer versatile mounting and connector options.

# Document Information

<b>Title</b>	<b>ANN-MB series</b>	
<b>Subtitle</b>	Multi-band, high precision GNSS antennas	
<b>Document type</b>	Data Sheet	
<b>Document number</b>	UBX-18049862	
<b>Revision and date</b>	R05	28-Nov-2022
<b>Disclosure Restriction</b>	Production Information	

<b>Product status</b>	<b>Corresponding content status</b>	
<b>In Development / Prototype</b>	Objective Specification	Target values. Revised and supplementary data will be published later.
<b>Engineering Sample</b>	Advance Information	Data based on early testing. Revised and supplementary data will be published later.
<b>Initial Production</b>	Early Production Information	Data from product verification. Revised and supplementary data may be published later.
<b>Mass Production / End of Life</b>	Production Information	Document contains the final product specification.

This document applies to the following products:

<b>Product name</b>	<b>Type number</b>	<b>Connector type</b>	<b>PCN reference</b>	<b>Product status</b>
ANN-MB (SMA)	ANN-MB-00-00	SMA	N/A	Mass Production
ANN-MB (SMB)	ANN-MB-01-00	SMB	N/A	Mass Production
ANN-MB (MCX)	ANN-MB-02-00	MCX	N/A	Mass Production

u-blox or third parties may hold intellectual property rights in the products, names, logos and designs included in this document. Copying, reproduction, modification or disclosure to third parties of this document or any part thereof is only permitted with the express written permission of u-blox.

The information contained herein is provided "as is" and u-blox assumes no liability for its use. No warranty, either express or implied, is given, including but not limited to, with respect to the accuracy, correctness, reliability and fitness for a particular purpose of the information. This document may be revised by u-blox at any time without notice. For the most recent documents, visit [www.u-blox.com](http://www.u-blox.com).

Copyright © u-blox AG.

# Contents

<b>Document Information .....</b>	<b>2</b>
<b>Contents .....</b>	<b>3</b>
<b>1 Overview .....</b>	<b>4</b>
<b>2 Electrical specification .....</b>	<b>4</b>
<b>3 Mechanical specification .....</b>	<b>5</b>
3.1 Mechanical drawing .....	5
3.2 Mechanical data .....	5
3.3 Connector types .....	5
<b>4 Environmental information .....</b>	<b>6</b>
<b>5 Absolute maximum ratings .....</b>	<b>6</b>
<b>6 Antenna characteristics .....</b>	<b>7</b>
6.1 Block diagram .....	7
6.2 Antenna phase center .....	7
6.3 Radiation pattern .....	8
<b>7 Product labeling .....</b>	<b>9</b>
7.1 Explanation of product codes .....	9
<b>8 Ordering information .....</b>	<b>10</b>
<b>9 Approvals and safety precaution .....</b>	<b>10</b>
9.1 Approvals .....	10
9.2 Safety precaution .....	10
<b>Revision history .....</b>	<b>11</b>
<b>Contact .....</b>	<b>12</b>

# 1 Overview

The u-blox ANN-MB multi-band (L1, L2/E5b/B2I) active GNSS antennas are designed to reduce time to market for the next generation of high precision GNSS applications, which require highly accurate location information. The compact design, excellent price to performance ratio, and versatile mounting and connector choices provide customers with fast, easy, and reliable multi-band antenna solutions. The ANN-MB antenna is a perfect match to the u-blox F9 platform, including the ZED-F9P module, thus providing customers with a valuable antenna solution to minimize design-in efforts.

The ANN-MB series includes a high-performance multi-band RHCP dual-feed patch antenna element, a built-in high-gain LNA with SAW pre-filtering, and a 5 m antenna cable with three connector options (SMA, SMB, MCX).

## 2 Electrical specification

### Patch antenna specification

Parameter	L1 Band	L2/E5b/B2I Band
Frequency <sup>1</sup>	1559-1606 MHz	1197-1249 MHz
Impedance <sup>1</sup>	50 Ω	50 Ω
Gain <sup>1</sup>	Typ. 3.5 dBic (Zenith)	Typ. 0.0-2.0 dBic (Zenith)
Axial ratio <sup>1</sup>	Max. 2.0 dB (Zenith)	Max. 2.0 dB (Zenith)
Polarization <sup>1</sup>	RHCP	RHCP

**Table 1: Patch antenna element specification**

### Amplifier specification

Parameter	L1 Band	L2/E5b/B2I Band
Frequency	1559-1606 MHz	1197-1249 MHz
Impedance	50 Ω	50 Ω
LNA Gain <sup>2,3</sup>	Typ. 28 ± 3.0 dB	Typ. 28 ± 3.0 dB
LNA Noise Figure <sup>2,3</sup>	Max. 2.8 dB	Max. 3.2 dB
Output VSWR	Max. 2.0	Max. 2.0
Cable Insertion Loss (RG-174, length 5 m)	Typ. 6.6 dB	Typ. 5.6 - 6.6 dB
Total Gain <sup>2,4</sup>	Typ. 21.4 dB	Typ. 21.4 - 22.4 dB
Out-of-band rejection		
min. 100 MHz from GNSS band edges at selected cellular bands	Typ. 65 dB (at <1459 MHz), 70 dB (>1706 MHz) Typ. 85 / 80 / 70 / 75 / 80 dB (at 698 / 960 / 1710 / 2170 / 2690 MHz)	Typ. 50 dB (at <1097 MHz), 75 dB (>1349 MHz) Typ. 65 / 45 / 45 / 75 / 80 dB (at 698 / 960 / 1710 / 2170 / 2690 MHz)
Supply voltage <sup>5</sup>	3.0 - 5.0 V	
Supply current <sup>2,5</sup>	Typ. 15 mA	

**Table 2: Amplifier specification**

<sup>1</sup> Measured on a ø15 cm ground plane. Measured values include the antenna feed network (hybrid coupler).

<sup>2</sup> Measured using 5.0 V supply voltage

<sup>3</sup> Includes LNA and SAW pre-filter section

<sup>4</sup> Includes LNA Gain and Cable Insertion Loss

<sup>5</sup> Single supply for L1 and L2/E5b/B2I bands

### 3 Mechanical specification

#### 3.1 Mechanical drawing

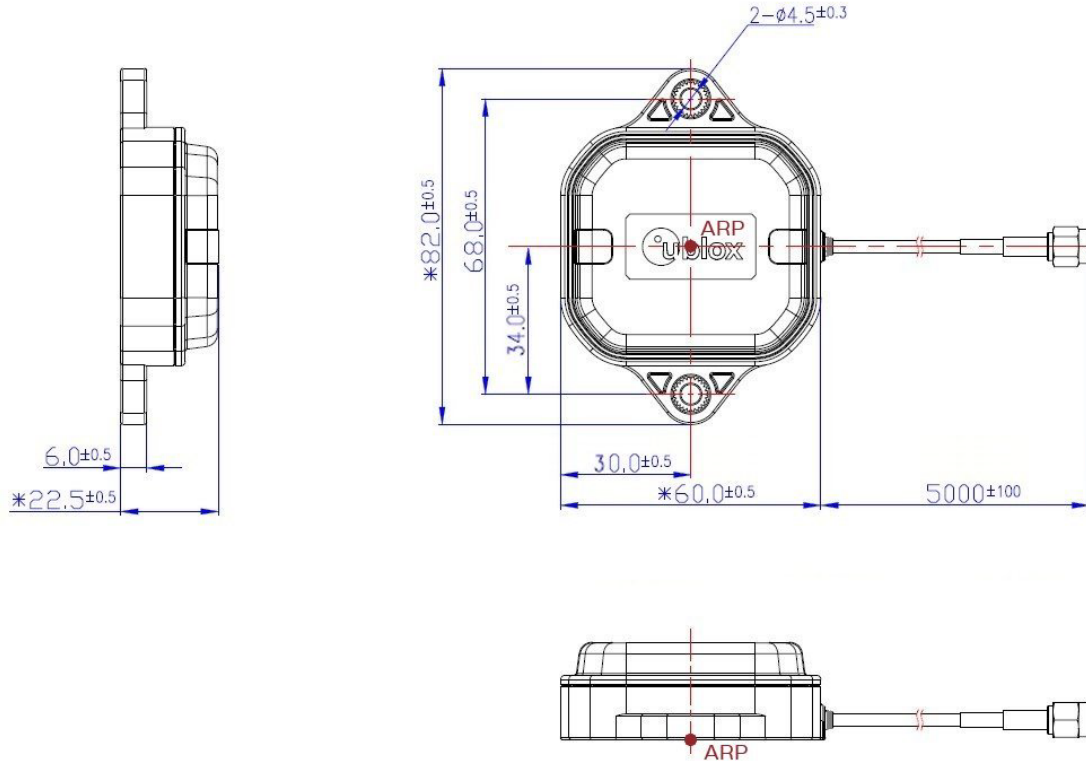

Figure 1: ANN-MB series mechanical drawing. Dimensions are given in mm. The antenna reference point (ARP) is marked with a red dot.

#### 3.2 Mechanical data

Parameter	Specification
Weight (Typical incl. cable)	173 g
Size	82.0 x 60.0 x 22.5 mm <sup>3</sup>
Connector options	SMA, SMB, MCX
Cable type, length	RG174, 5.0 m
Mounting	Magnetic base, fixed installation option (screw mount, 2 x M4 screws)
Housing Color	Black

Table 3: Mechanical specification

#### 3.3 Connector types



Table 4: ANN-MB connector types

## 4 Environmental information



Parameter	Specification
Operating temperature	-40 to +85 °C
Storage temperature	-40 to +85 °C
ESD circuit protection	±15 kV (IEC61000-4-2)
Ingress protection (IP) rating	IP67 (Protected from dust and temporary immersion in water up to 1 m depth)
Humidity	95%RH, 60 °C, 96 hours
Vibration	MIL-STD-810G, Method 514.7 Vibration

**Table 5: Environmental information**

## 5 Absolute maximum ratings

Parameter	Symbol	Condition	Min	Max	Units
Power supply voltage	VCC		0.0	10.0	V
Operating temperature	T <sub>OP</sub>		-40	+85	°C
Storage temperature	T <sub>STG</sub>		-40	+85	°C

**Table 6: Absolute maximum ratings**

- 
 Stress above one or more of the limiting values may cause permanent damage to the device. These are stress ratings only. Operation of the device at these or at any other conditions above those given below is not implied. Exposure to limiting values for extended periods may affect device reliability.
- 
 The product is not protected against overvoltage or reversed voltages. Voltage spikes exceeding the power supply voltage specification, given in the table above, must be limited to values within the specified boundaries by using appropriate protection diodes.

## 6 Antenna characteristics

### 6.1 Block diagram

A simplified block diagram for ANN-MB multi-band antenna series is shown in [Figure 2](#). The block diagram is divided into patch antenna element and amplifier sections. The patch antenna element section is specified in [Table 1](#) and the amplifier section in [Table 2](#). The 5 m coaxial cable is connected to the amplifier section output.

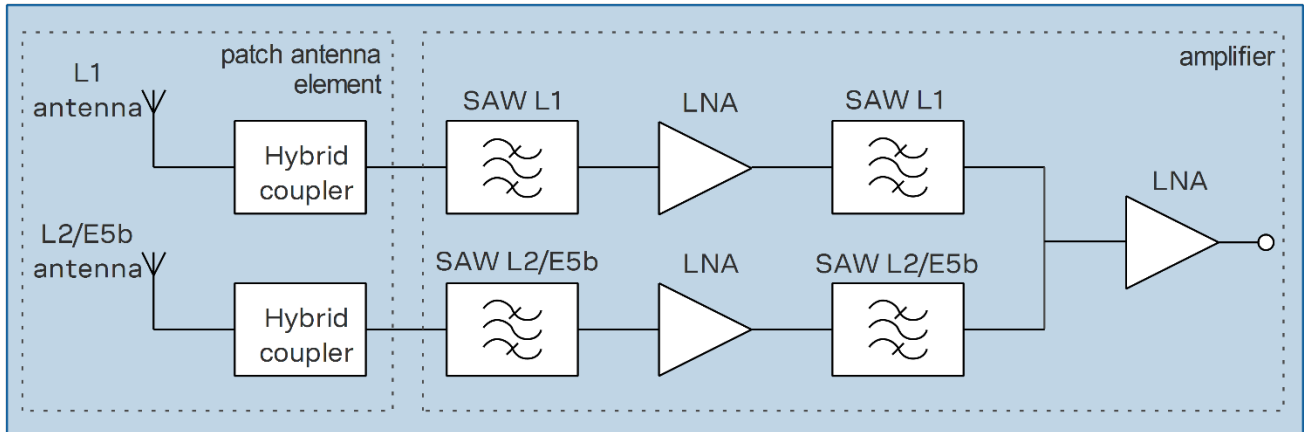

Figure 2: Simplified ANN-MB series block diagram

### 6.2 Antenna phase center

Typical values for the absolute antenna phase center offset in L1 and L2 bands are given in [Table 7](#). The phase center offset is given in millimeters with respect to the antenna reference point defined in [Figure 1](#). The “North” direction is toward the cable connector. The “Up” direction is normal to the antenna ground plane, toward the patch element.

The phase center offset is measured on a circular ground plane with 120 mm diameter. Any change in ground plane size or shape may affect the phase center offset.

GNSS	Frequency	Phase center offset		Phase center variation
		Horizontal plane	Up	Over all azimuth/elevation
GPS L1 C/A	1575.42 MHz	< 5 mm in all directions	8.9 mm	< 5 mm
GPS L2C	1227.60 MHz	< 5 mm in all directions	7.6 mm	<10 mm

Table 7: Typical values for phase center offset and variation relative to antenna reference point (ARP) in L1 and L2 bands. Measured on a circular 120 mm ground plane.

### 6.3 Radiation pattern

The radiation pattern in the L1 and L2 bands are shown in [Figure 4](#) and [Figure 5](#), respectively. The 2-D cuts for  $H(xy)$ ,  $E1(xz)$ , and  $E2(yz)$  planes are shown at BeiDou, GPS, and Glonass frequencies. The coordinate axes are defined in [Figure 3](#).

Note: The spherical coordinate system used represent radiation pattern data is different from the “North”, “East”, “Up” coordinate system used for antenna phase center offset in section 6.2.

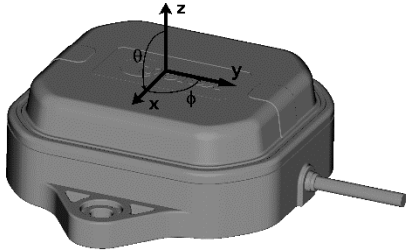

Figure 3: Definition of coordinate axes for radiation pattern plots.

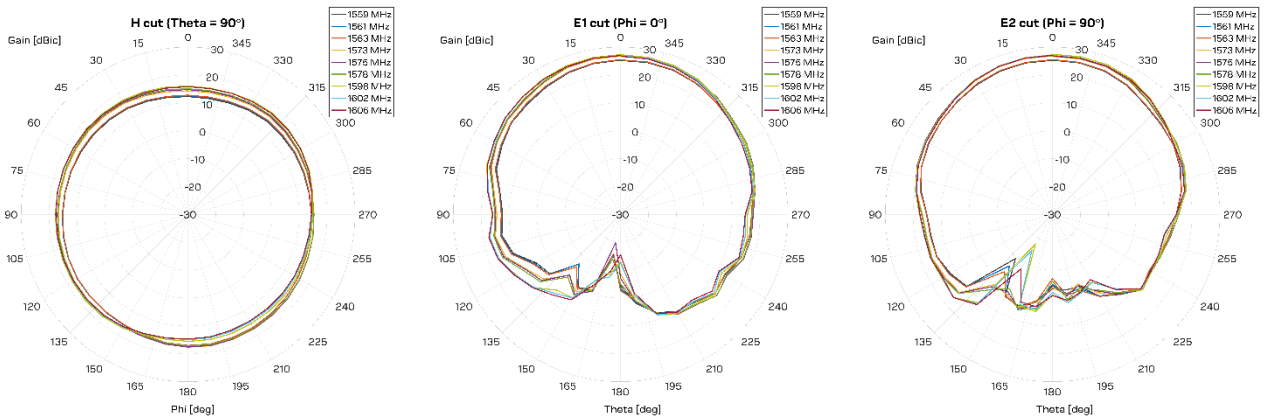

Figure 4: Radiation pattern in L1 band. The 2-D cuts are measured at 1559 - 1606 MHz (nine frequencies).

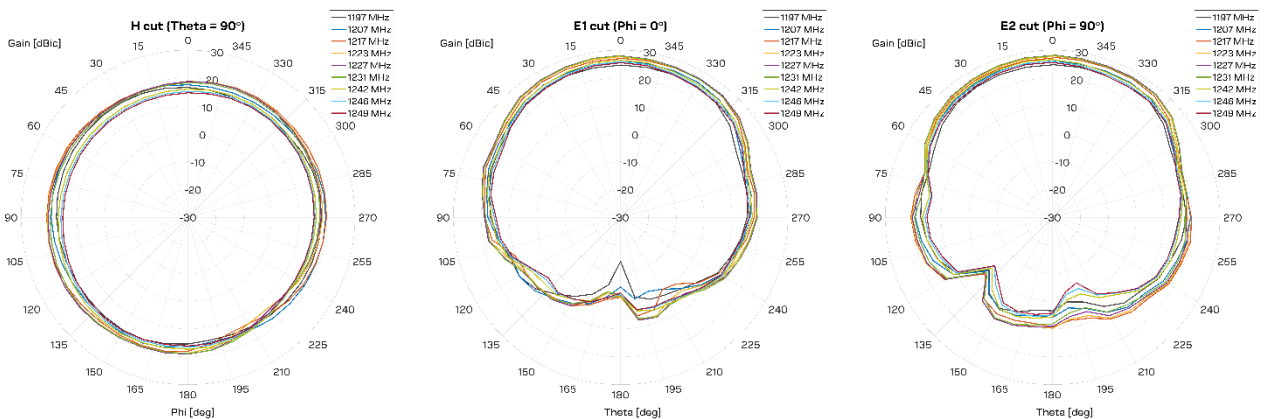

Figure 5: Radiation pattern in L2 band. The 2-D cuts are measured at 1197 - 1249 MHz (nine frequencies).

## 7 Product labeling

The product information label is found on the underside of the ANN-MB multi-band GNSS antenna. The label includes the product type number, which provides important information on the product.

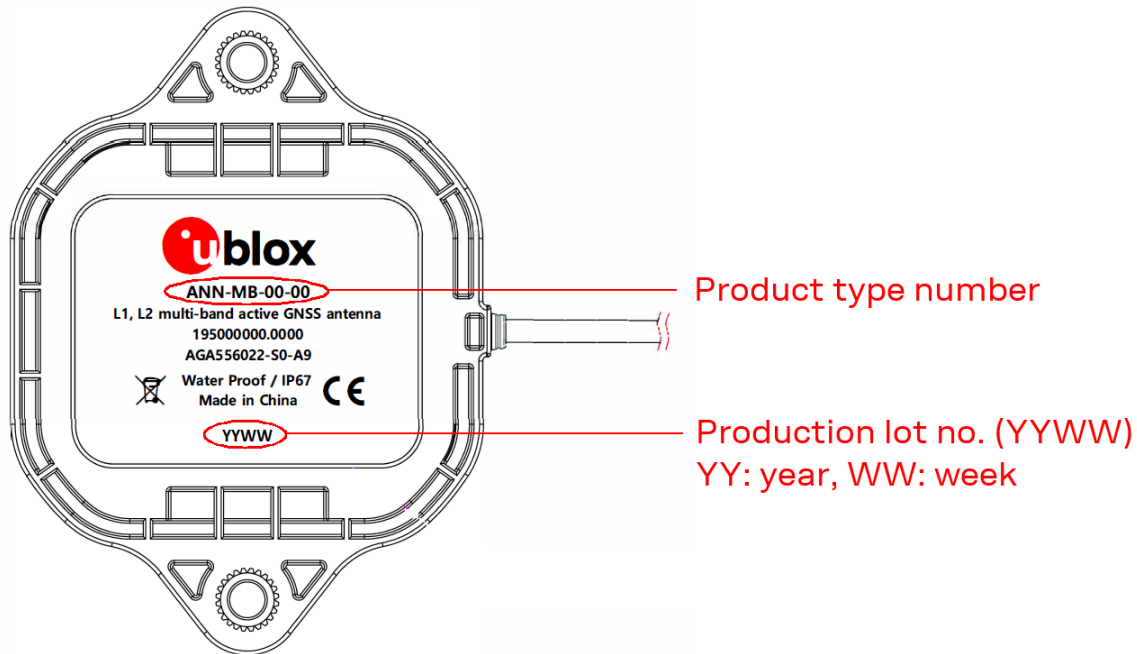

Figure 6: ANN-MB multi-band GNSS antenna product label. ANN-MB is produced in China or in Korea.

### 7.1 Explanation of product codes

Three different product code formats are used. The **Product name** is used in general communications about product families and variants. The **Ordering code** includes options, whereas the **Type number** includes information on the hardware version. The product code formats are described in [Table 8](#) and [Table 9](#).

Format	Structure
Product name	PPP-GV
Ordering code	PPP-GV-NN
Type number	PPP-GV-NN-XX

Table 8: Product code formats

Code	Meaning	Example
PPP	Product family	ANN
GV	Product generation	MB: Multi-band
NN	Option	Connector type: 00 = SMA connector 01 = SMB connector 02 = MCX connector
XX	Product revision	

Table 9: Explanation of product codes

## 8 Ordering information

Ordering No.	Product
ANN-MB-00	Multi-band active GNSS antenna, 5 m cable, SMA (plug) connector Single units
ANN-MB-01	Multi-band active GNSS antenna, 5 m cable, SMB (plug) connector Single units
ANN-MB-02	Multi-band active GNSS antenna, 5 m cable, MCX (plug) connector Single units

Table 10: Ordering information

## 9 Approvals and safety precaution

### 9.1 Approvals

ANN-MB complies with all the essential requirements for RED 2014/53/EU. The ANN-MB Declaration of Conformity (DoC) is available at [www.u-blox.com](http://www.u-blox.com) within Support > Product resources > Conformity Declaration.

ANN-MB complies with the Directive 2011/65/EU (EU RoHS 2) and its amendment Directive (EU) 2015/863 (EU RoHS 3).

### 9.2 Safety precaution

ANN-MB shall be supplied by a power supply complying with the requirements of PS1 according to safety standard EN 62368-1 (<https://webstore.iec.ch/publication/27412>).

## Revision history

Revision	Date	Name	Status / Comments
R01	10-Sep-2018	rmak	Objective Specification.
R02	10-Dec-2018	rmak	Advance Information. Updated Figure 1 and Table 5 for added fix installation option. Updated Table 2 (outband rejection), Table 3 (antenna weight) and section 6.3 (Radiation Pattern). Adjusted temperature specification (Table 5). Added section 5 (absolute maximum ratings) and Figure 6 (product label information).
R03	18-Feb-2019	rmak	Early Production Information. Updated Table 2 (out-of-band rejection values), Figure 1 (mechanical drawing), Table 3 (mechanical data), Table 4 (ANN-MB connector types), Table 5 (environmental information), Figure 6 (product label), section 6.3 (radiation pattern). Added section 9 Approvals and safety information.
R04	09-Jul-2019	rmak	Production Information. Added B2I in supported bands in section 1 and section 2. Included antenna reference point (ARP) in Figure 1. Added section 6.2 (Antenna phase center). Revised connector description to "plug" in Table 4 and Table 10. Modified wording of the RoHS statement in section 9.1.
R05	28-Nov-2022	rmak	Updated section 5 Absolute maximum ratings. Editorial change. Updated section 7 Product labeling. Added China as a country of origin (China and Korea). Updated section Contact.



## Contact

Address: u-blox AG  
Zürcherstrasse 68  
8800 Thalwil  
Switzerland







For further support and contact information, visit us at [www.u-blox.com/support](http://www.u-blox.com/support).

## Looking for pricing, stock, or lifecycle information?

Click below to explore more details on WIN SOURCE:

-  [View ANN-MB-00 on WIN SOURCE](#)
-  [U-blox Information](#)

## Optimize Your Supply Chain with WIN SOURCE Solutions

-  Global Sourcing Solution
-  Obsolete Management
-  Cost Control Management
-  Shortage Management
-  Alternative Solution
-  Excess Inventory Management