



# THE DATASHEET OF IRGI4045



# IRGI4045DPbF

## INSULATED GATE BIPOLAR TRANSISTOR WITH ULTRAFAST SOFT RECOVERY DIODE

### Features

- Low  $V_{CE(on)}$  Trench IGBT Technology
- Low Switching Losses
- 5 $\mu$ s SCSOA
- Square RBSOA
- 100% of The Parts Tested for  $I_{LM}$ ①
- Positive  $V_{CE(on)}$  Temperature Coefficient.
- Ultra Fast Soft Recovery Co-pak Diode
- Tighter Distribution of Parameters
- Lead-Free Package

### Benefits

- High Efficiency in a Wide Range of Applications
- Suitable for a Wide Range of Switching Frequencies due to Low  $V_{CE(ON)}$  and Low Switching Losses
- Rugged Transient Performance for Increased Reliability
- Excellent Current Sharing in Parallel Operation
- Low EMI

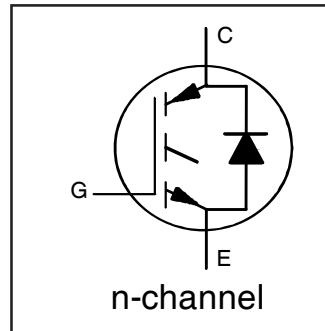

$V_{CES} = 600V$
$I_C = 6.0A, T_C = 100^\circ C$
$t_{sc} > 5\mu s, T_{jmax} = 150^\circ C$
$V_{CE(on) typ.} = 1.70V$

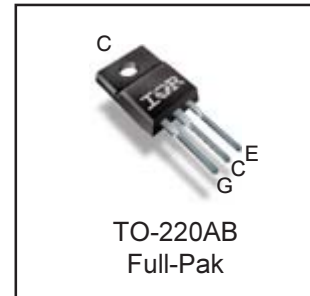

<b>G</b>	<b>C</b>	<b>E</b>
Gate	Collector	Emitter

### Absolute Maximum Ratings

	Parameter	Max.	Units
$V_{CES}$	Collector-to-Emitter Breakdown Voltage	600	V
$I_C @ T_C = 25^\circ C$	Continuous Collector Current	11	A
$I_C @ T_C = 100^\circ C$	Continuous Collector Current	6	
$I_{CM}$	Pulse Collector Current, $V_{GE}=15V$	18	
$I_{LM}$	Clamped Inductive Load Current, $V_{GE}=20V$ ①	24	
$I_F @ T_C=25^\circ C$	Diode Continuous Forward Current	11	
$I_F @ T_C=100^\circ C$	Diode Continuous Forward Current	6	
$I_{FM}$	Diode Maximum Forward Current ②	24	
$V_{GE}$	Continuous Gate-to-Emitter Voltage	$\pm 20$	V
	Transient Gate-to-Emitter Voltage	$\pm 30$	
$P_D @ T_C = 25^\circ C$	Maximum Power Dissipation	33	W
$P_D @ T_C = 100^\circ C$	Maximum Power Dissipation	13	
$T_J$ $T_{STG}$	Operating Junction and Storage Temperature Range	-55 to + 150	$^\circ C$
	Soldering Temperature, for 10 seconds	300 (0.063 in. (1.6mm) from case)	
	Mounting Torque, 6-32 or M3 Screw	10 lbf-in (1.1 N-m)	

### Thermal Resistance

	Parameter	Min.	Typ.	Max.	Units
$R_{\theta JC}$	Junction-to-Case - IGBT ③	—	—	3.76	$^\circ C/W$
$R_{\theta JC}$	Junction-to-Case - Diode ③	—	—	9.00	
$R_{\theta CS}$	Case-to-Sink, flat, greased surface	—	0.5	—	
$R_{\theta JA}$	Junction-to-Ambient, typical socket mount ③	—	—	65	
Wt	Weight	—	2.0	—	g

Electrical Characteristics @  $T_J = 25^\circ\text{C}$  (unless otherwise specified)

	Parameter	Min.	Typ.	Max.	Units	Conditions
$V_{(BR)CES}$	Collector-to-Emitter Breakdown Voltage	600	—	—	V	$V_{GE} = 0V, I_C = 100 \mu\text{A}$ ④
$\Delta V_{(BR)CES}/\Delta T_J$	Temperature Coeff. of Breakdown Voltage	—	0.75	—	V/°C	$V_{GE} = 0V, I_C = 250 \mu\text{A}$ ( $-55^\circ\text{C}$ to $150^\circ\text{C}$ ) ④
$V_{CE(on)}$	Collector-to-Emitter Saturation Voltage	—	1.70	2.0		$I_C = 6A, V_{GE} = 15V, T_J = 25^\circ\text{C}$
		—	2.01	—	V	$I_C = 6A, V_{GE} = 15V, T_J = 125^\circ\text{C}$
		—	2.10	—		$I_C = 6A, V_{GE} = 15V, T_J = 150^\circ\text{C}$
$V_{GE(th)}$	Gate Threshold Voltage	4.0		6.5	V	$V_{CE} = V_{GE}, I_C = 150 \mu\text{A}$
$\Delta V_{GE(th)}/\Delta T_J$	Threshold Voltage temp. coefficient	—	-14	—	mV/°C	$V_{CE} = V_{GE}, I_C = 1.0\text{mA}$ ( $-55^\circ\text{C}$ to $150^\circ\text{C}$ )
$g_{fe}$	Forward Transconductance	—	3.5	—	S	$V_{CE} = 50V, I_C = 6A, PW = 80\mu\text{s}$
$I_{CES}$	Collector-to-Emitter Leakage Current	—	—	25	$\mu\text{A}$	$V_{GE} = 0V, V_{CE} = 600V$
		—	—	250	$\mu\text{A}$	$V_{GE} = 0V, V_{CE} = 600V, T_J = 150^\circ\text{C}$
$V_{FM}$	Diode Forward Voltage Drop	—	1.60	2.3	V	$I_F = 6A$
		—	1.33	—		$I_F = 6A, T_J = 150^\circ\text{C}$
$I_{GES}$	Gate-to-Emitter Leakage Current	—	—	$\pm 100$	nA	$V_{GE} = \pm 20 V$

Switching Characteristics @  $T_J = 25^\circ\text{C}$  (unless otherwise specified)

	Parameter	Min.	Typ.	Max.	Units	Conditions
$Q_g$	Total Gate Charge (turn-on)	—	13	20		$I_C = 6A$
$Q_{ge}$	Gate-to-Emitter Charge (turn-on)	—	3.3	5.0	nC	$V_{CC} = 400V$
$Q_{gc}$	Gate-to-Collector Charge (turn-on)	—	5.9	8.9		$V_{GE} = 15V$
$E_{on}$	Turn-On Switching Loss	—	64	169		$I_C = 6A, V_{CC} = 400V, V_{GE} = 15V$
$E_{off}$	Turn-Off Switching Loss	—	123	229	$\mu\text{J}$	$R_G = 47\Omega, L = 1\text{mH}, L_S = 150\text{nH}, T_J = 25^\circ\text{C}$
$E_{total}$	Total Switching Loss	—	187	296		Energy losses include tail and diode reverse recovery
$t_{d(on)}$	Turn-On delay time	—	26	35		$I_C = 6A, V_{CC} = 400V$
$t_r$	Rise time	—	13	22	ns	$R_G = 47\Omega, L = 1\text{mH}, L_S = 150\text{nH}$
$t_{d(off)}$	Turn-Off delay time	—	73	84		$T_J = 25^\circ\text{C}$
$t_f$	Fall time	—	19	28		
$E_{on}$	Turn-On Switching Loss	—	126	—		$I_C = 6A, V_{CC} = 400V, V_{GE} = 15V$
$E_{off}$	Turn-Off Switching Loss	—	169	—	$\mu\text{J}$	$R_G = 47\Omega, L = 1\text{mH}, L_S = 150\text{nH}, T_J = 150^\circ\text{C}$
$E_{total}$	Total Switching Loss	—	294	—		Energy losses include tail and diode reverse recovery
$t_{d(on)}$	Turn-On delay time	—	25	—		$I_C = 6A, V_{CC} = 400V$
$t_r$	Rise time	—	13	—	ns	$R_G = 47\Omega, L = 1\text{mH}, L_S = 150\text{nH}$
$t_{d(off)}$	Turn-Off delay time	—	86	—		$T_J = 150^\circ\text{C}$
$t_f$	Fall time	—	30	—		
$C_{ies}$	Input Capacitance	—	354	—		$V_{GE} = 0V$
$C_{oes}$	Output Capacitance	—	29	—	pF	$V_{CC} = 30V$
$C_{res}$	Reverse Transfer Capacitance	—	9.4	—		$f = 1\text{Mhz}$
RBSOA	Reverse Bias Safe Operating Area	FULL SQUARE				$T_J = 150^\circ\text{C}, I_C = 24A$ $V_{CC} = 480V, V_p = 600V$ $R_G = 47\Omega, V_{GE} = +20V$ to $0V$
SCSOA	Short Circuit Safe Operating Area	5	—	—	$\mu\text{s}$	$V_{CC} = 400V, V_p = 600V$ $R_G = 47\Omega, V_{GE} = +15V$ to $0V$
$E_{rec}$	Reverse recovery energy of the diode	—	147	—	$\mu\text{J}$	$T_J = 150^\circ\text{C}$
$t_{rr}$	Diode Reverse recovery time	—	73	—	ns	$V_{CC} = 400V, I_F = 6A$
$I_{rr}$	Peak Reverse Recovery Current	—	11	—	A	$V_{GE} = 15V, R_G = 47\Omega, L = 1\text{mH}, L_S = 150\text{nH}$

## Notes:

- ①  $V_{CC} = 80\% (V_{CES}), V_{GE} = 20V, L = 28 \mu\text{H}, R_G = 47 \Omega$
- ② Pulse width limited by max. junction temperature.
- ③  $R_\theta$  is measured at  $T_J$  approximately  $90^\circ\text{C}$
- ④ Refer to AN-1086 for guidelines for measuring  $V_{(BR)CES}$  safely

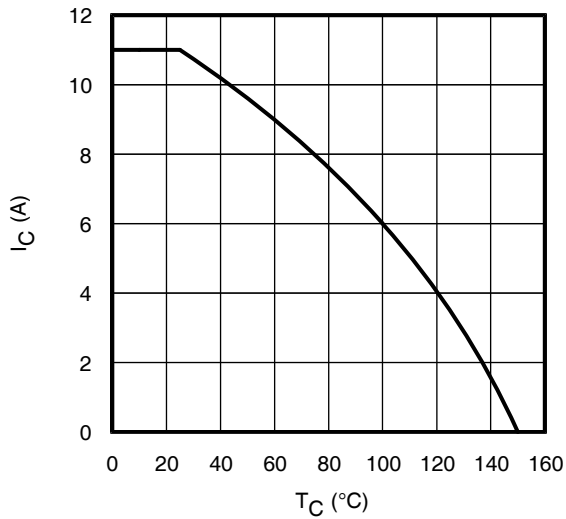

**Fig. 1** - Maximum DC Collector Current vs. Case Temperature

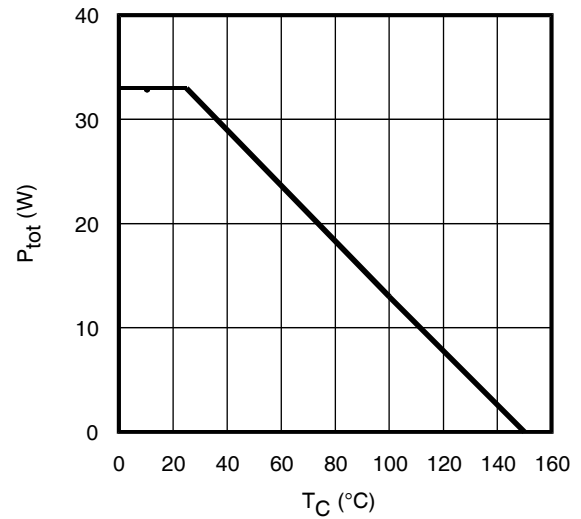

**Fig. 2** - Power Dissipation vs. Case Temperature

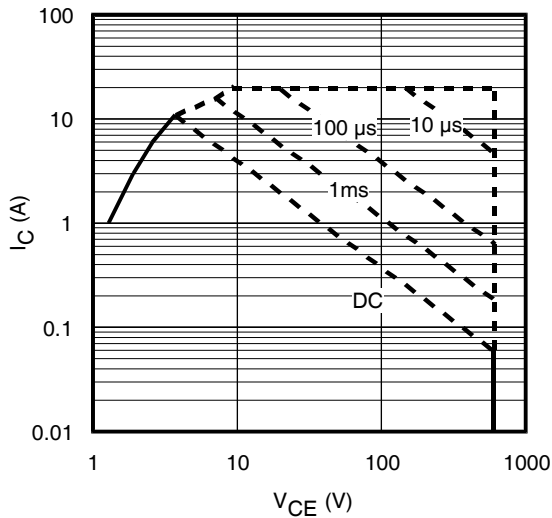

**Fig. 3** - Forward SOA,  
 $T_C = 25^\circ\text{C}$ ;  $T_J \leq 150^\circ\text{C}$

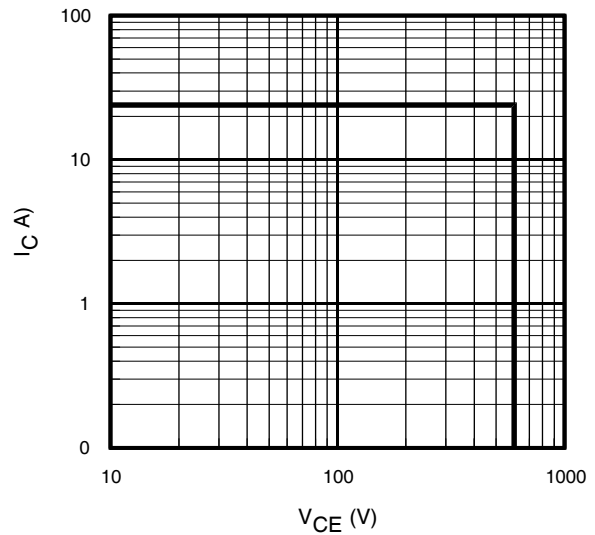

**Fig. 4** - Reverse Bias SOA  
 $T_J = 150^\circ\text{C}$ ;  $V_{CE} = 15\text{V}$

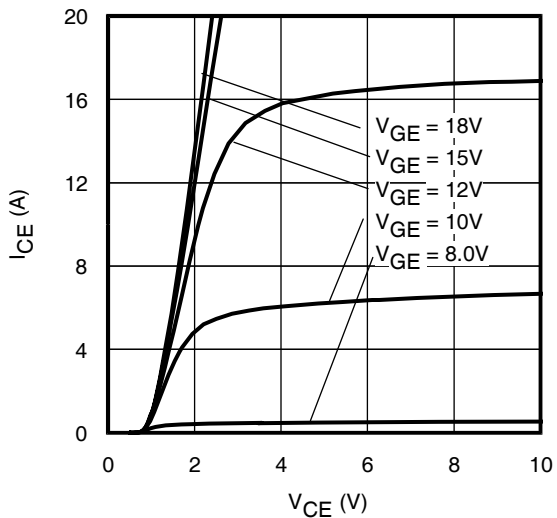

**Fig. 5** - Typ. IGBT Output Characteristics  
 $T_J = -40^\circ\text{C}$ ;  $t_p < 60\mu\text{s}$

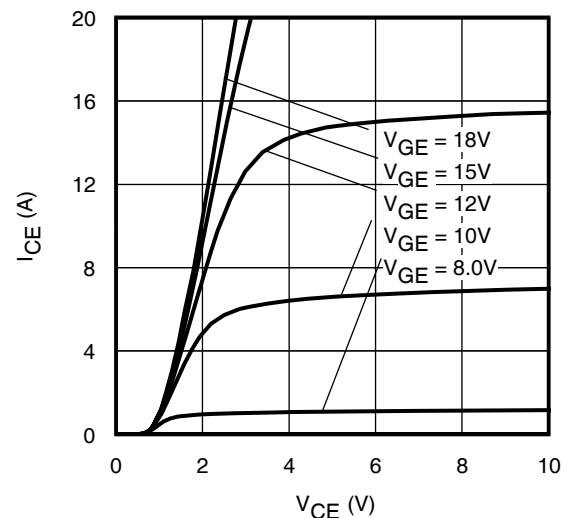

**Fig. 6** - Typ. IGBT Output Characteristics  
 $T_J = 25^\circ\text{C}$ ;  $t_p < 60\mu\text{s}$

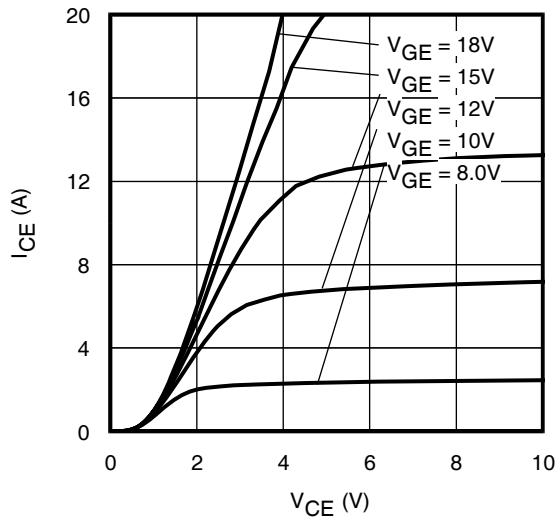

**Fig. 7** - Typ. IGBT Output Characteristics  
 $T_J = 150^\circ\text{C}$ ;  $t_p < 60\mu\text{s}$

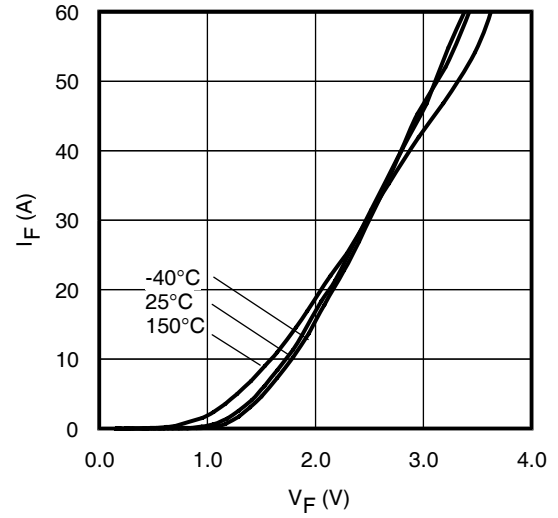

**Fig. 8** - Typ. Diode Forward Characteristics  
 $t_p < 60\mu\text{s}$

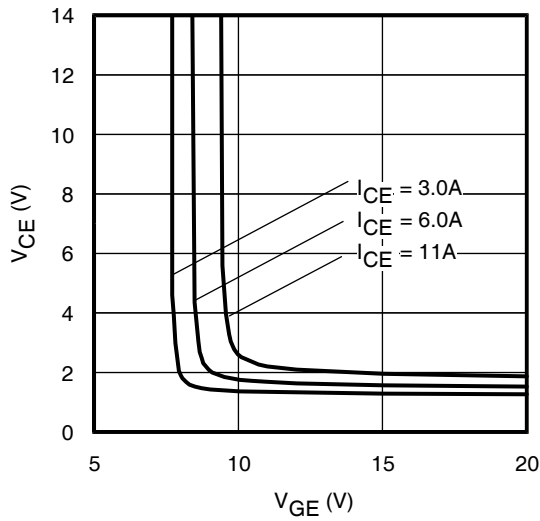

**Fig. 9** - Typical  $V_{CE}$  vs.  $V_{GE}$   
 $T_J = -40^\circ\text{C}$

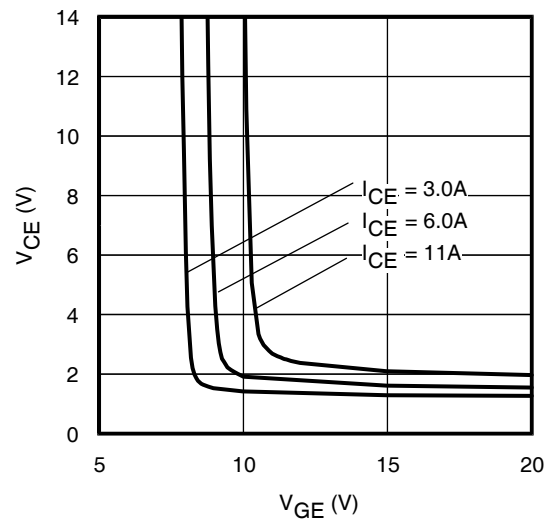

**Fig. 10** - Typical  $V_{CE}$  vs.  $V_{GE}$   
 $T_J = 25^\circ\text{C}$

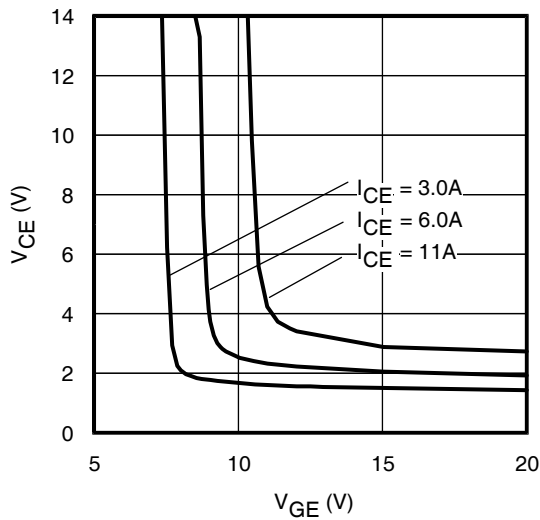

**Fig. 11** - Typical  $V_{CE}$  vs.  $V_{GE}$   
 $T_J = 150^\circ\text{C}$

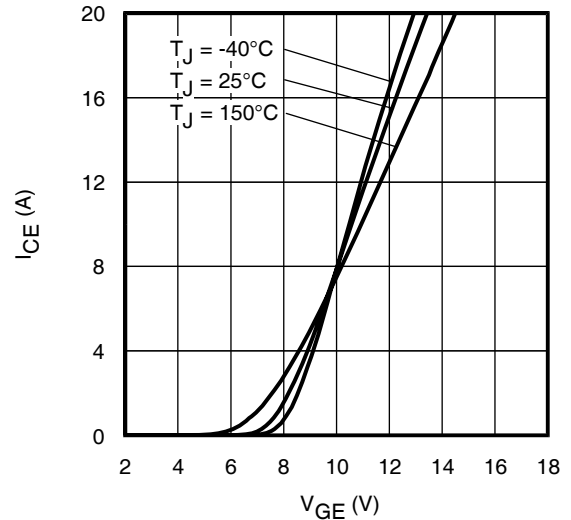

**Fig. 12** - Typ. Transfer Characteristics  
 $V_{CE} = 50\text{V}$ ;  $t_p < 60\mu\text{s}$

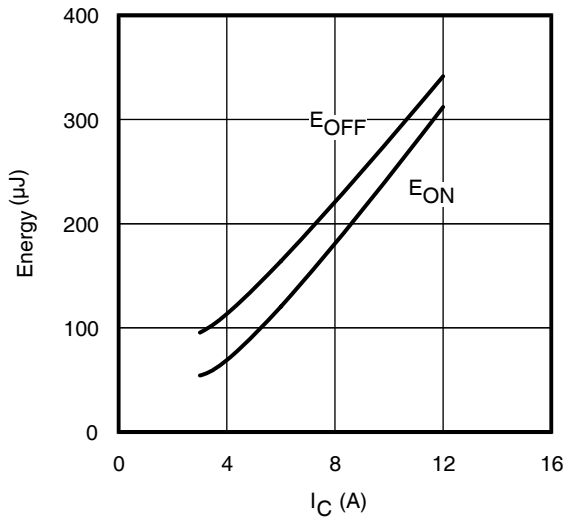

**Fig. 13** - Typ. Energy Loss vs.  $I_C$   
 $T_J = 150^\circ\text{C}$ ;  $L = 1\text{mH}$ ;  $V_{CE} = 400\text{V}$ ,  $R_G = 47\Omega$ ;  $V_{GE} = 15\text{V}$ .

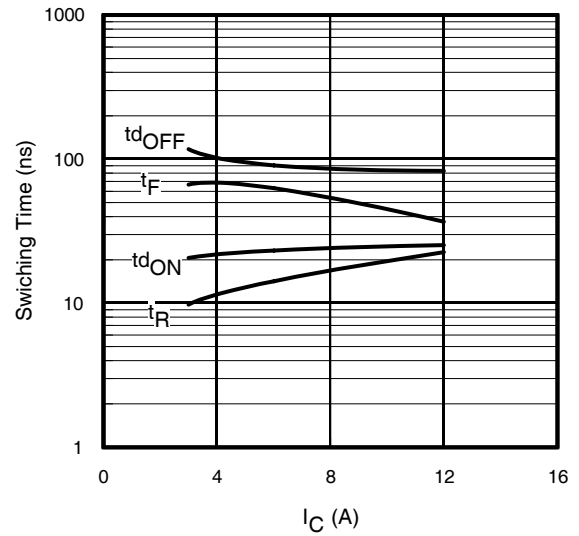

**Fig. 14** - Typ. Switching Time vs.  $I_C$   
 $T_J = 150^\circ\text{C}$ ;  $L = 1\text{mH}$ ;  $V_{CE} = 400\text{V}$   
 $R_G = 47\Omega$ ;  $V_{GE} = 15\text{V}$

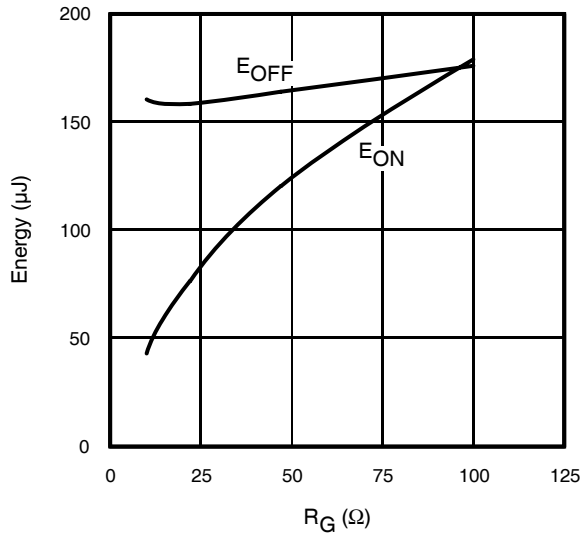

**Fig. 15** - Typ. Energy Loss vs.  $R_G$   
 $T_J = 150^\circ\text{C}$ ;  $L = 1\text{mH}$ ;  $V_{CE} = 400\text{V}$ ,  $I_{CE} = 6.0\text{A}$ ;  $V_{GE} = 15\text{V}$

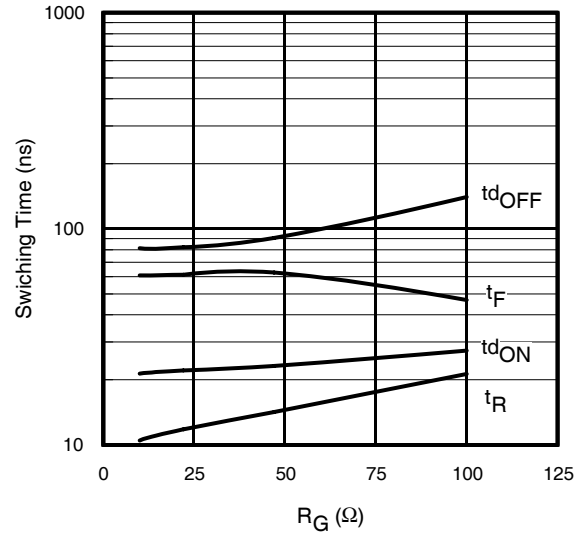

**Fig. 16** - Typ. Switching Time vs.  $R_G$   
 $T_J = 150^\circ\text{C}$ ;  $L = 1\text{mH}$ ;  $V_{CE} = 400\text{V}$   
 $I_{CE} = 6.0\text{A}$ ;  $V_{GE} = 15\text{V}$

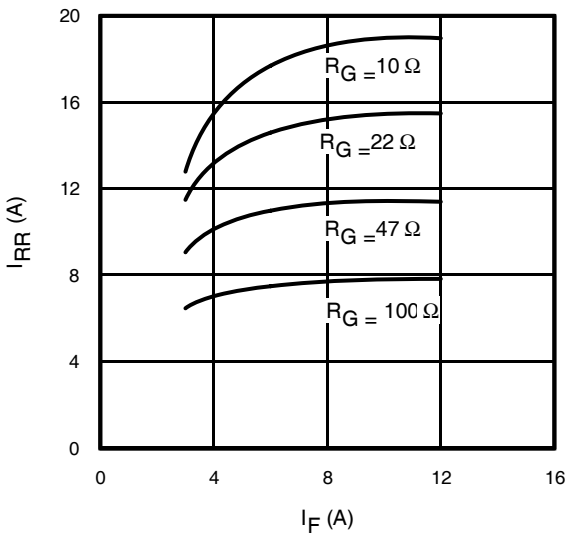

**Fig. 17** - Typical Diode  $I_{RR}$  vs.  $I_F$   
 $T_J = 150^\circ\text{C}$

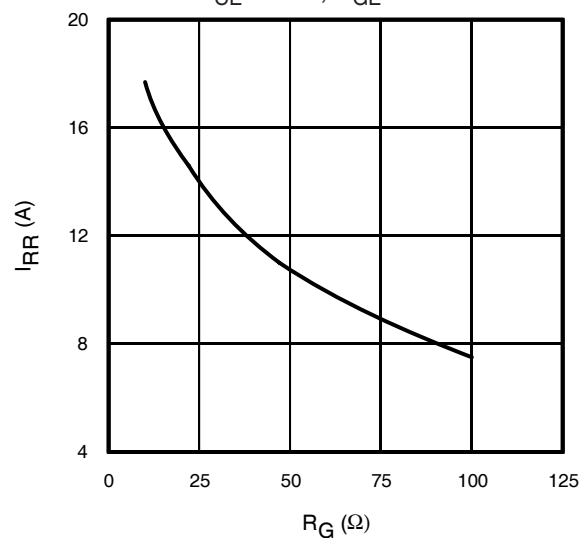

**Fig. 18** - Typical Diode  $I_{RR}$  vs.  $R_G$   
 $T_J = 150^\circ\text{C}$ ;  $I_F = 6.0\text{A}$

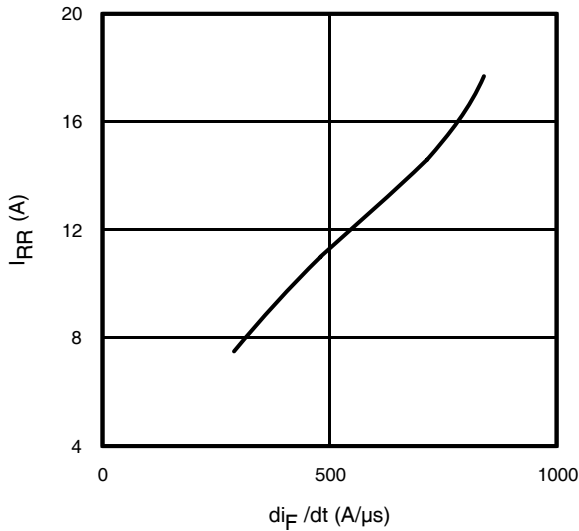

**Fig. 19**- Typical Diode  $I_{RR}$  vs.  $di_F/dt$   
 $V_{CC}=400V$ ;  $V_{GE}=15V$ ;  
 $I_{CE}=11A$ ;  $T_J=150^{\circ}C$

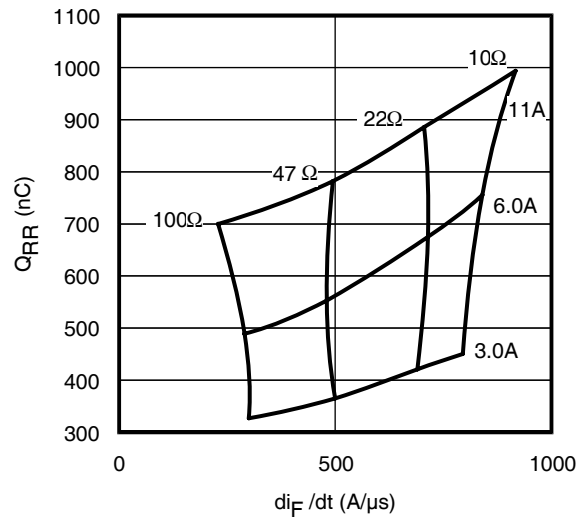

**Fig. 20** - Typical Diode  $Q_{RR}$   
 $V_{CC}=400V$ ;  $V_{GE}=15V$ ;  $T_J=150^{\circ}C$

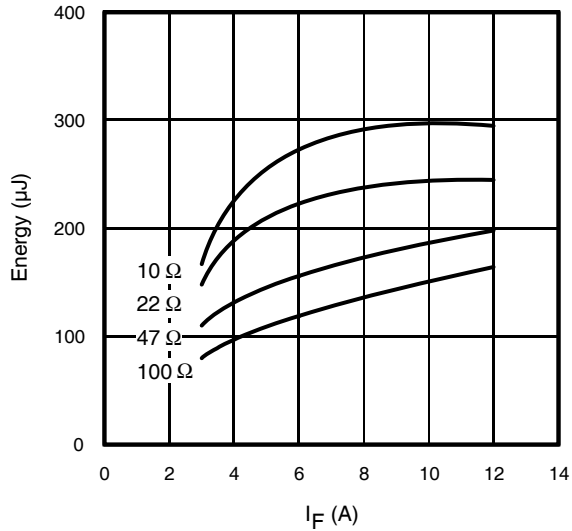

**Fig. 21** - Typical Diode  $E_{RR}$  vs.  $I_F$   
 $T_J=150^{\circ}C$

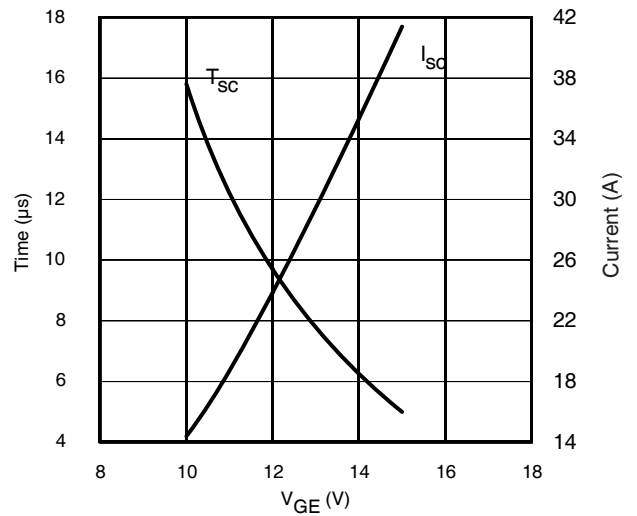

**Fig. 22**- Typ.  $V_{GE}$  vs Short Circuit Time  
 $V_{CC}=400V$ ,  $T_C=25^{\circ}C$

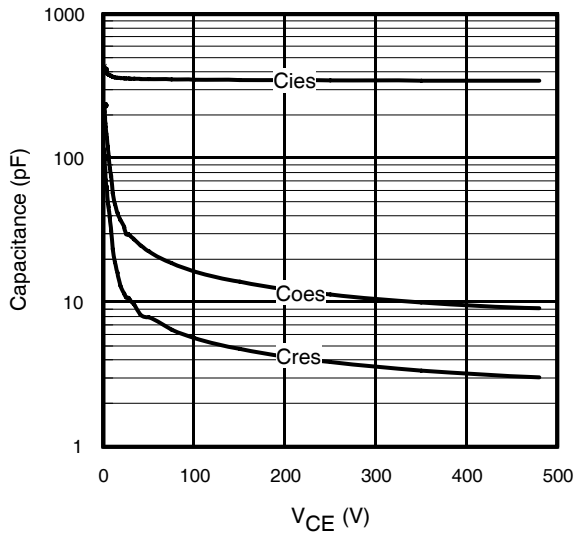

**Fig. 23**- Typ. Capacitance vs.  $V_{CE}$   
 $V_{GE}=0V$ ;  $f=1MHz$

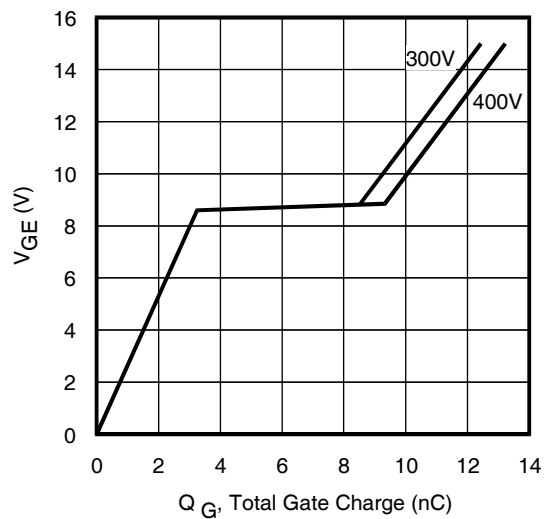

**Fig. 24** - Typical Gate Charge vs.  $V_{GE}$   
 $I_{CE}=11A$ ,  $L=600\mu H$

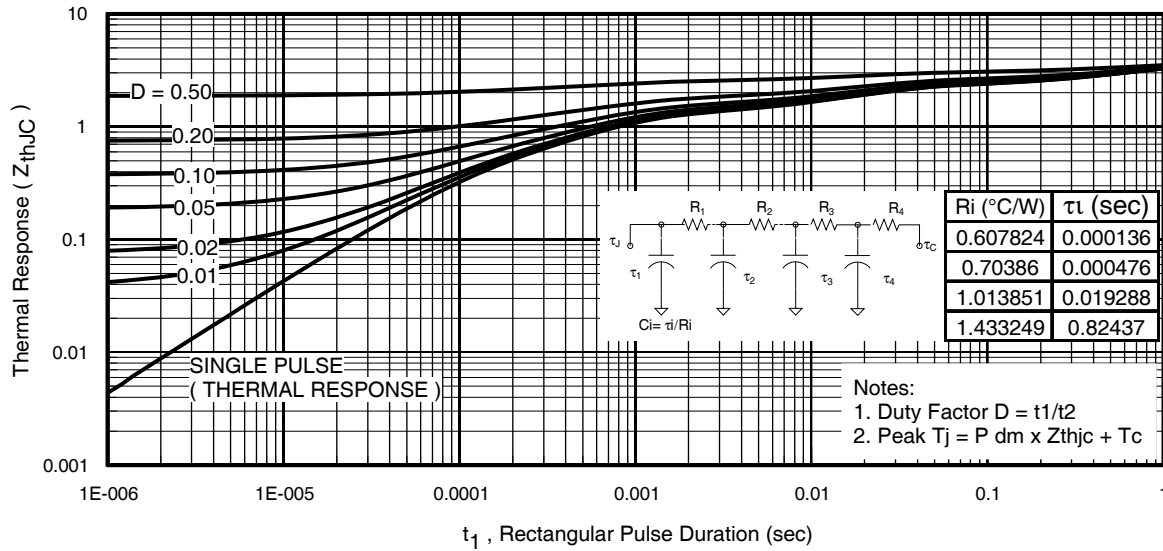

Fig 25. Maximum Transient Thermal Impedance, Junction-to-Case (IGBT)

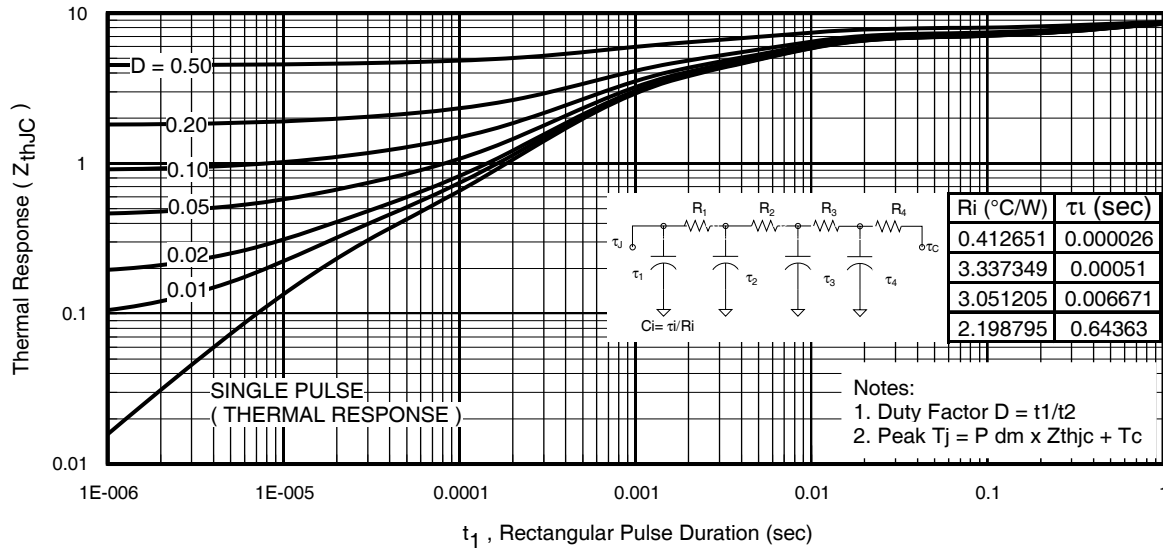
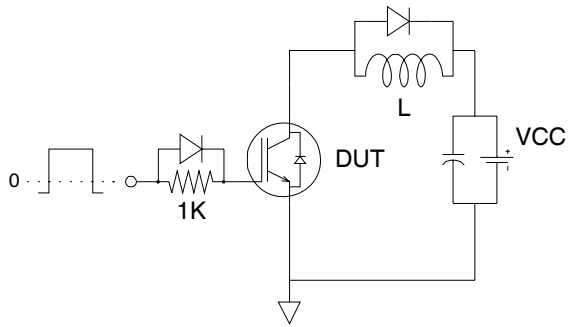
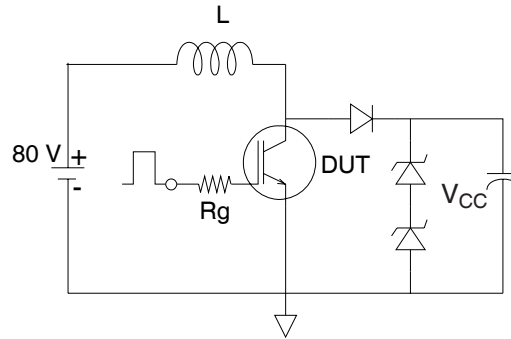

Fig. 26. Maximum Transient Thermal Impedance, Junction-to-Case (DIODE)



**Fig.C.T.1** - Gate Charge Circuit (turn-off)



**Fig.C.T.2** - RBSOA Circuit

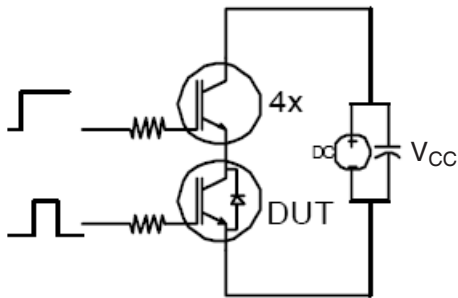

**Fig.C.T.3** - S.C.SOA Circuit

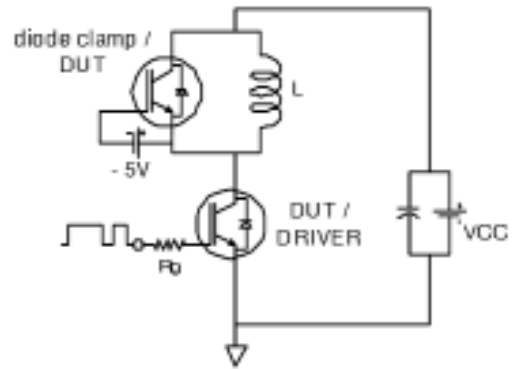

**Fig.C.T.4** - Switching Loss Circuit

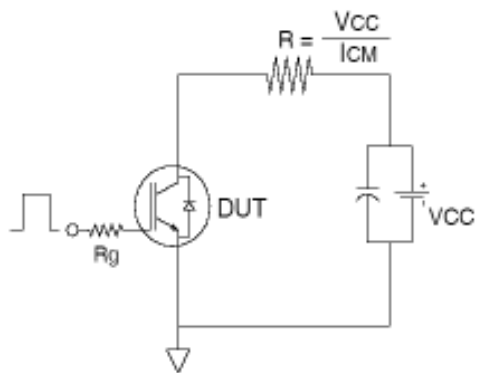

**Fig.C.T.5** - Resistive Load Circuit

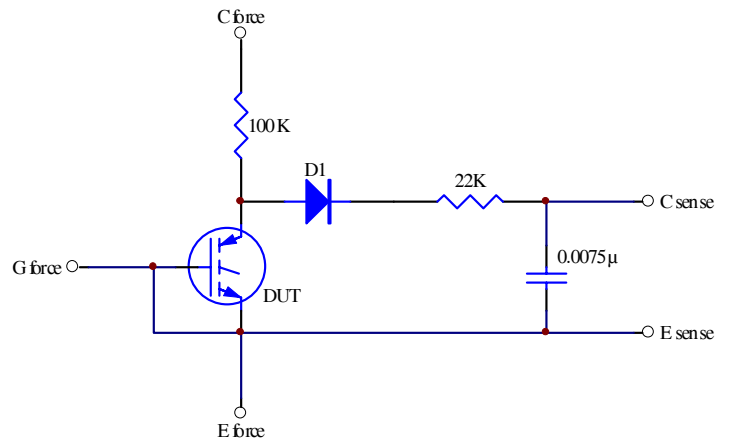

**Fig.C.T.6** - Typical Filter Circuit for  $V_{(BR)CES}$  Measurement

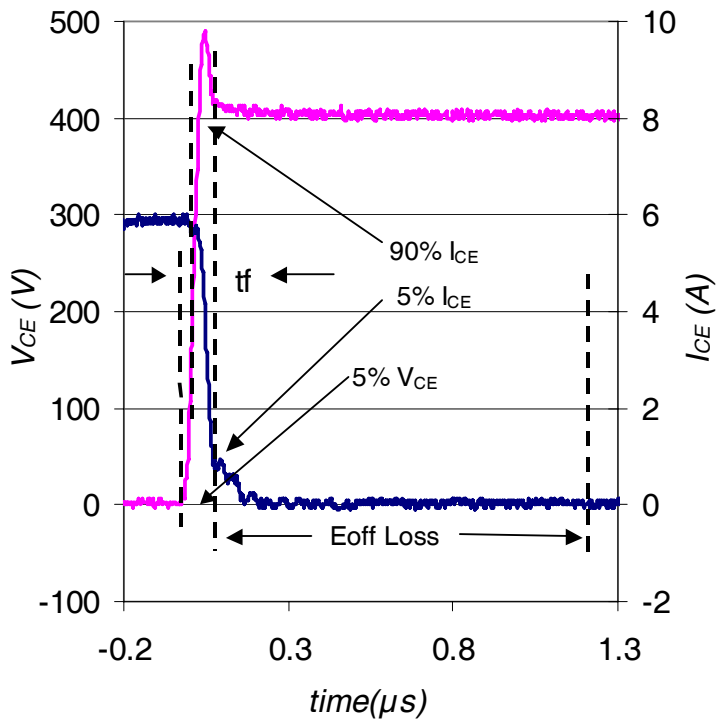

**Fig. WF1** - Typ. Turn-off Loss Waveform  
@  $T_J = 150^\circ\text{C}$  using Fig. CT.4

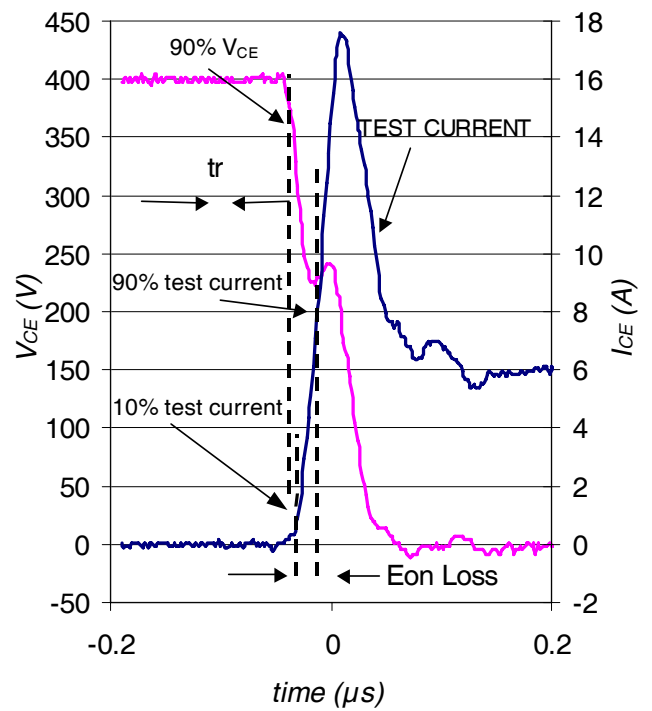

**Fig. WF2** - Typ. Turn-on Loss Waveform  
@  $T_J = 150^\circ\text{C}$  using Fig. CT.4

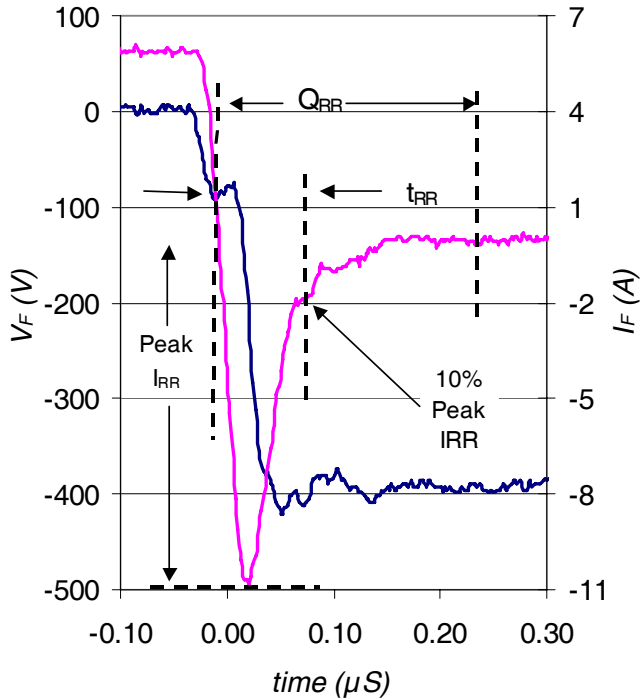

**WF.3**- Typ. Reverse Recovery Waveform  
@  $T_J = 150^\circ\text{C}$  using CT.4

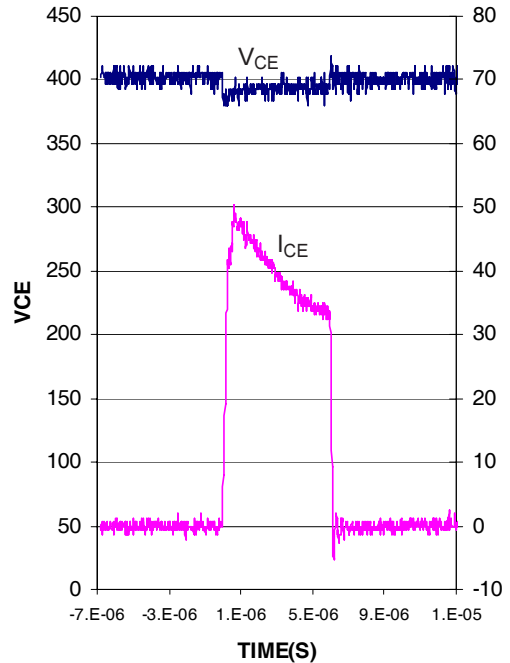



**WF.4**- Typ. Short Circuit Waveform  
@  $T_J = 25^\circ\text{C}$  using CT.3



## Looking for pricing, stock, or lifecycle information?

Click below to explore more details on WIN SOURCE:

-  [View IRGI4045 on WIN SOURCE](#)
-  [Infineon Technologies](#) Information

## Optimize Your Supply Chain with WIN SOURCE Solutions

-  Global Sourcing Solution
-  Obsolete Management
-  Cost Control Management
-  Shortage Management
-  Alternative Solution
-  Excess Inventory Management