



THE DATASHEET OF IRG4RC20F



IRG4RC20F

INSULATED GATE BIPOLAR TRANSISTOR

Fast Speed IGBT

Features

- Fast: Optimized for medium operating frequencies (1-5 kHz in hard switching, >20 kHz in resonant mode).
- Generation 4 IGBT design provides tighter parameter distribution and higher efficiency than previous generation IGBTs.
- Industry standard TO-252AA package
- Combines very low $V_{CE(on)}$ with low switching losses

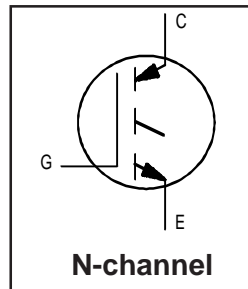

$V_{CES} = 600V$
$V_{CE(on)} \text{ typ.} = 1.82V$
@ $V_{GE} = 15V, I_C = 12A$

Benefits

- Generation 4 IGBTs offer highest efficiency
- Optimized for specific application conditions
- High power density and current rating



Absolute Maximum Ratings

	Parameter	Max.	Units
V_{CES}	Collector-to-Emitter Breakdown Voltage	600	V
$I_C @ T_C = 25^\circ C$	Continuous Collector Current	22	A
$I_C @ T_C = 100^\circ C$	Continuous Collector Current	12	
I_{CM}	Pulsed Collector Current ①	44	
I_{LM}	Clamped Inductive Load Current ②	44	
V_{GE}	Gate-to-Emitter Voltage	± 20	V
E_{ARV}	Reverse Voltage Avalanche Energy ③	5.0	mJ
$P_D @ T_C = 25^\circ C$	Maximum Power Dissipation	66	W
$P_D @ T_C = 100^\circ C$	Maximum Power Dissipation	26	
T_J T_{STG}	Operating Junction and Storage Temperature Range	-55 to + 150	°C
	Soldering Temperature, for 10 seconds	300 (0.063 in. (1.6mm) from case)	
	Mounting torque, 6-32 or M3 screw.	10 lbf•in (1.1N•m)	

Thermal Resistance

	Parameter	Typ.	Max.	Units
$R_{\theta JC}$	Junction-to-Case	—	1.9	°C/W
$R_{\theta JA}$	Junction-to-Ambient (PCB mount)*	—	50	
Wt	Weight	0.3 (0.01)	—	g (oz)

* When mounted on 1" square PCB (FR-4 or G-10 Material).

For recommended footprint and soldering techniques refer to application note #AN-994

IRG4RC20F

Electrical Characteristics @ $T_J = 25^\circ\text{C}$ (unless otherwise specified)

	Parameter	Min.	Typ.	Max.	Units	Conditions
$V_{(BR)CES}$	Collector-to-Emitter Breakdown Voltage	600	—	—	V	$V_{GE} = 0V, I_C = 250\mu A$
$V_{(BR)ECS}$	Emitter-to-Collector Breakdown Voltage ④	18	—	—	V	$V_{GE} = 0V, I_C = 1.0A$
$\Delta V_{(BR)CES}/\Delta T_J$	Temperature Coeff. of Breakdown Voltage	—	0.72	—	V/°C	$V_{GE} = 0V, I_C = 1.0mA$
$V_{CE(ON)}$	Collector-to-Emitter Saturation Voltage	—	1.82	2.1	V	$I_C = 12A$ $I_C = 22A$ $I_C = 12A, T_J = 150^\circ\text{C}$ $V_{GE} = 15V$ See Fig.2, 5
		—	2.42	—		
		—	2.04	—		
$V_{GE(th)}$	Gate Threshold Voltage	3.0	—	6.0		$V_{CE} = V_{GE}, I_C = 250\mu A$
$\Delta V_{GE(th)}/\Delta T_J$	Temperature Coeff. of Threshold Voltage	—	-11	—	mV/°C	$V_{CE} = V_{GE}, I_C = 250\mu A$
g_{fe}	Forward Transconductance ⑤	5.2	7.75	—	S	$V_{CE} = 100V, I_C = 12A$
I_{CES}	Zero Gate Voltage Collector Current	—	—	250	μA	$V_{GE} = 0V, V_{CE} = 600V$
		—	—	2.0		$V_{GE} = 0V, V_{CE} = 10V, T_J = 25^\circ\text{C}$
		—	—	1000		$V_{GE} = 0V, V_{CE} = 600V, T_J = 150^\circ\text{C}$
I_{GES}	Gate-to-Emitter Leakage Current	—	—	± 100	nA	$V_{GE} = \pm 20V$

Switching Characteristics @ $T_J = 25^\circ\text{C}$ (unless otherwise specified)

	Parameter	Min.	Typ.	Max.	Units	Conditions
Q_g	Total Gate Charge (turn-on)	—	27	40	nC	$I_C = 12A$ $V_{CC} = 400V$ $V_{GE} = 15V$ See Fig. 8
Q_{ge}	Gate - Emitter Charge (turn-on)	—	4.8	6.8		
Q_{gc}	Gate - Collector Charge (turn-on)	—	11.4	17		
$t_{d(on)}$	Turn-On Delay Time	—	26	—	ns	$T_J = 25^\circ\text{C}$ $I_C = 12A, V_{CC} = 480V$ $V_{GE} = 15V, R_G = 50\Omega$ Energy losses include "tail" See Fig. 9, 10, 14
t_r	Rise Time	—	24	—		
$t_{d(off)}$	Turn-Off Delay Time	—	194	290		
t_f	Fall Time	—	226	340		
E_{on}	Turn-On Switching Loss	—	0.19	—	mJ	See Fig. 9, 10, 14
E_{off}	Turn-Off Switching Loss	—	0.92	—		
E_{ts}	Total Switching Loss	—	1.11	1.4		
$t_{d(on)}$	Turn-On Delay Time	—	25	—	ns	$T_J = 150^\circ\text{C},$ $I_C = 12A, V_{CC} = 480V$ $V_{GE} = 15V, R_G = 50\Omega$ Energy losses include "tail" See Fig. 11, 14
t_r	Rise Time	—	26	—		
$t_{d(off)}$	Turn-Off Delay Time	—	263	—		
t_f	Fall Time	—	443	—		
E_{ts}	Total Switching Loss	—	1.89	—	mJ	
L_E	Internal Emitter Inductance	—	7.5	—	nH	Measured 5mm from package
C_{ies}	Input Capacitance	—	540	—	pF	$V_{GE} = 0V$ $V_{CC} = 30V$ $f = 1.0MHz$ See Fig. 7
C_{oes}	Output Capacitance	—	37	—		
C_{res}	Reverse Transfer Capacitance	—	7.0	—		

Notes:

- ① Repetitive rating; $V_{GE} = 20V$, pulse width limited by max. junction temperature. (See fig. 13b)
- ② $V_{CC} = 80\%(V_{CES}), V_{GE} = 20V, L = 10\mu H, R_G = 50\Omega,$ (See fig. 13a)
- ③ Repetitive rating; pulse width limited by maximum junction temperature.
- ④ Pulse width $\leq 80\mu s$; duty factor $\leq 0.1\%$.
- ⑤ Pulse width $5.0\mu s$, single shot.

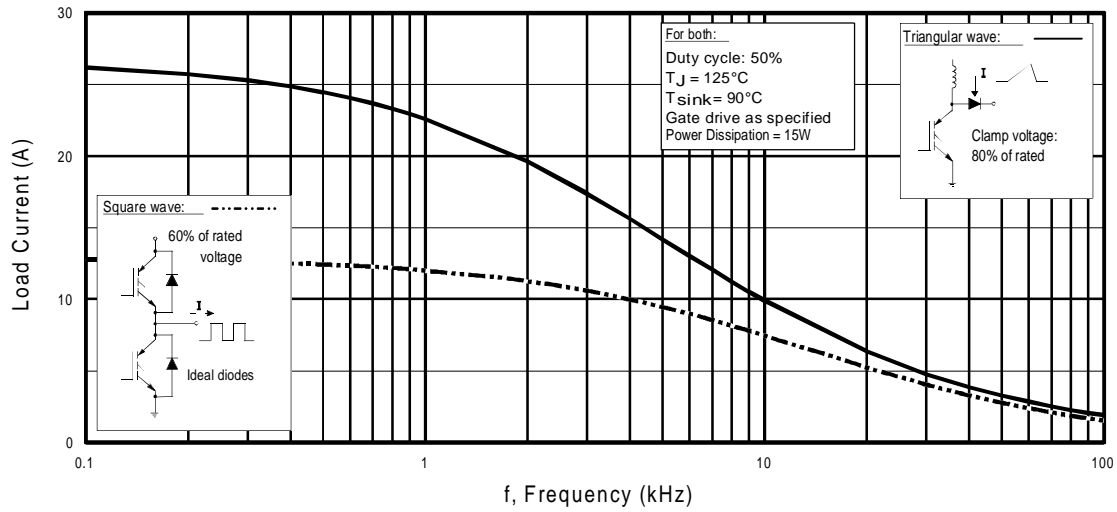

Fig. 1 - Typical Load Current vs. Frequency
 (Load Current = I_{RMS} of fundamental)

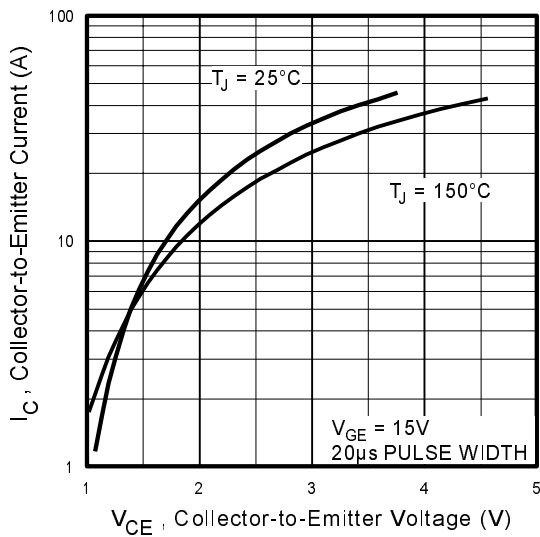

Fig. 2 - Typical Output Characteristics

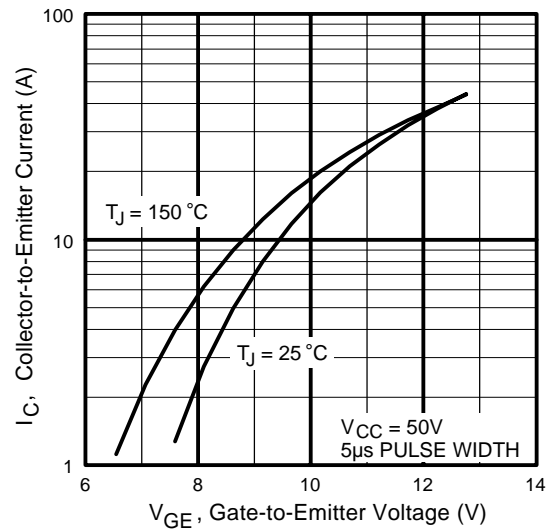

Fig. 3 - Typical Transfer Characteristics

IRG4RC20F

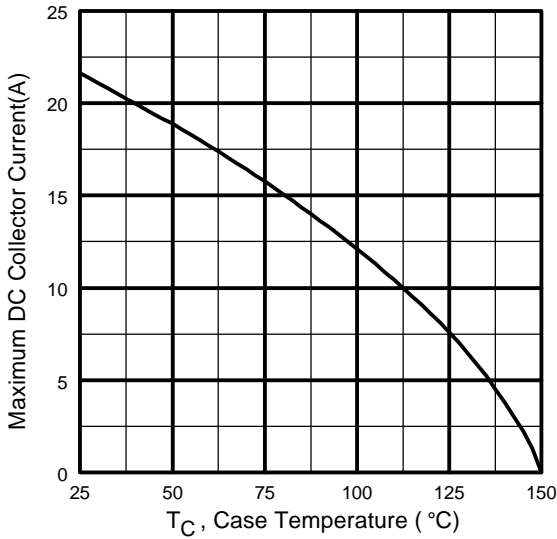

Fig. 4 - Maximum Collector Current vs. Case Temperature

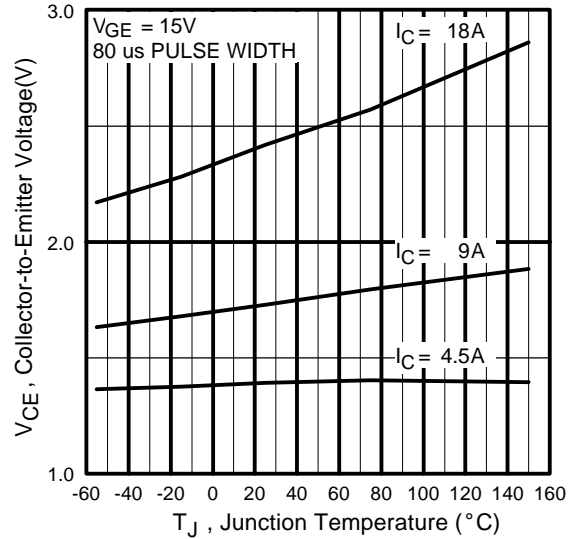

Fig. 5 - Typical Collector-to-Emitter Voltage vs. Junction Temperature

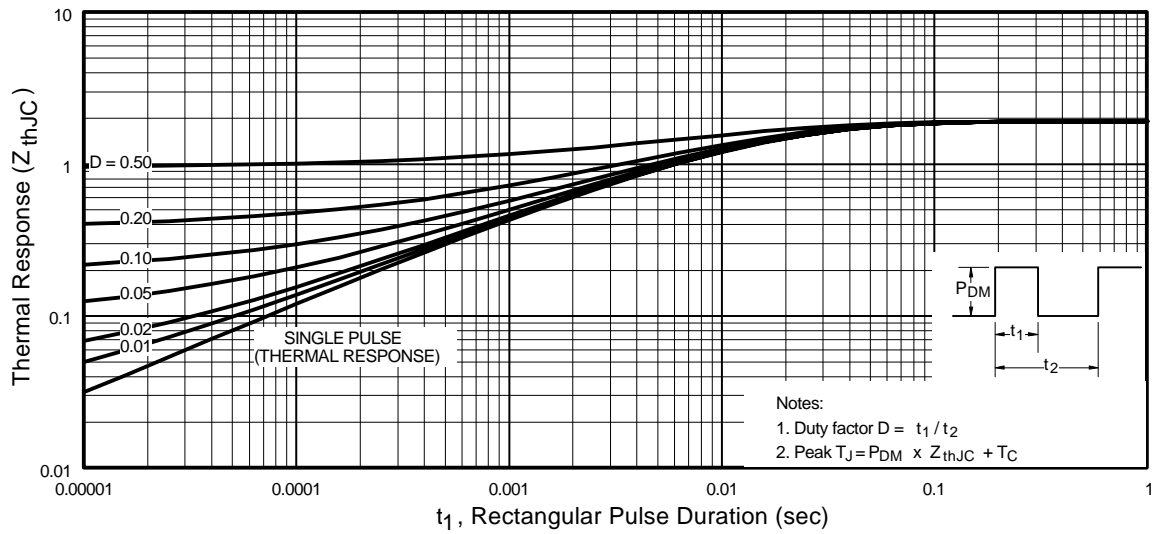

Fig. 6 - Maximum Effective Transient Thermal Impedance, Junction-to-Case

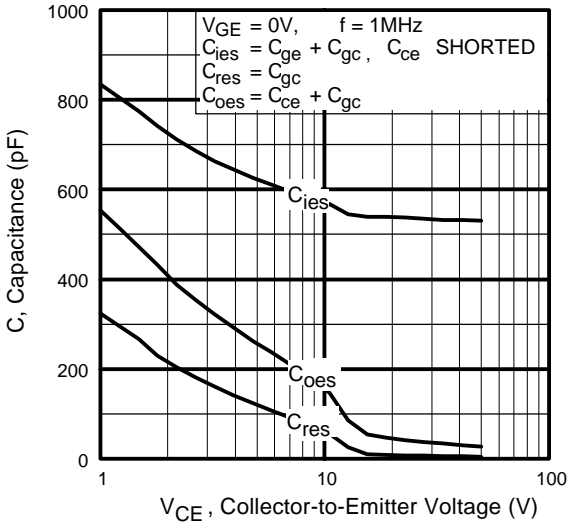

Fig. 7 - Typical Capacitance vs. Collector-to-Emitter Voltage

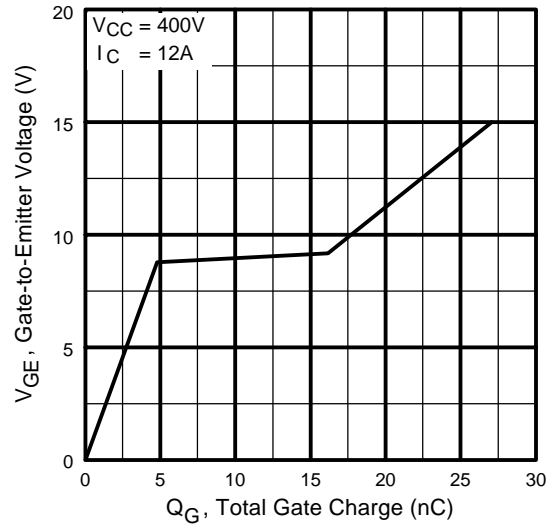

Fig. 8 - Typical Gate Charge vs. Gate-to-Emitter Voltage

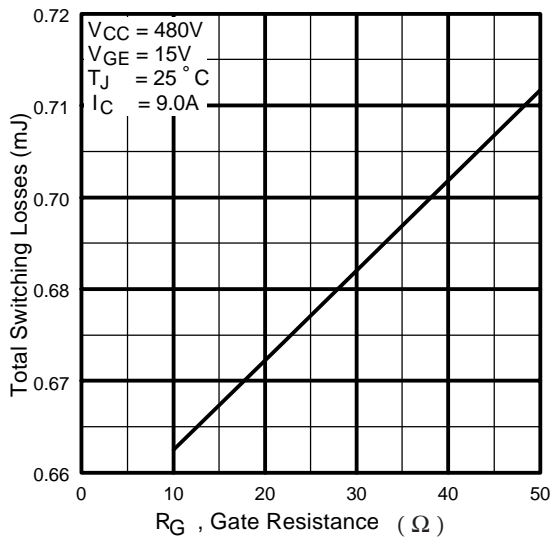

Fig. 9 - Typical Switching Losses vs. Gate Resistance

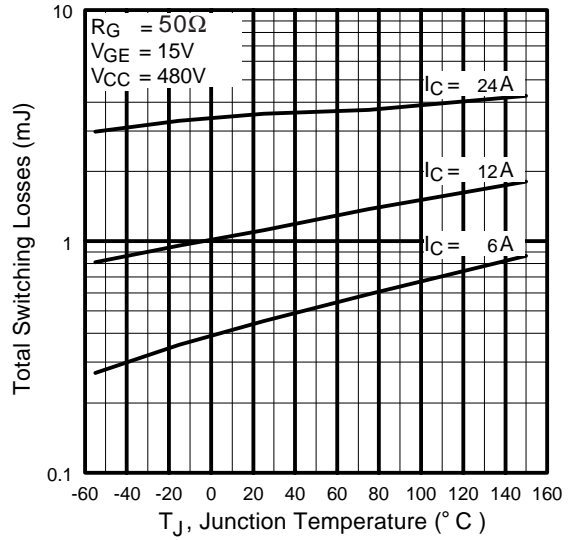

Fig. 10 - Typical Switching Losses vs. Junction Temperature

IRG4RC20F

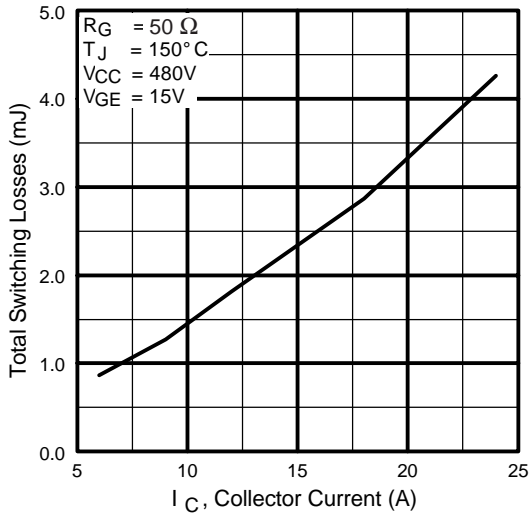

Fig. 11 - Typical Switching Losses vs. Collector-to-Emitter Current

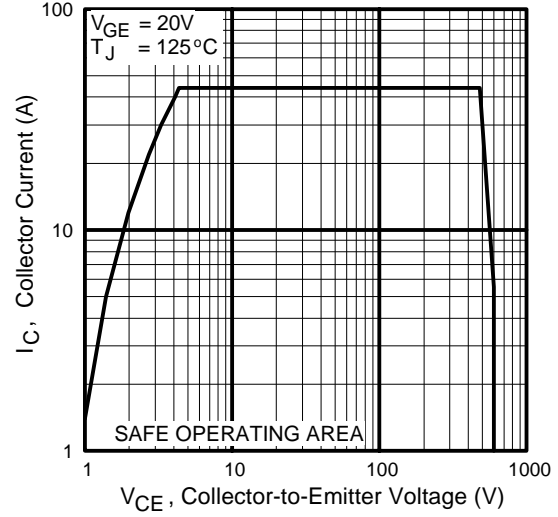

Fig. 12 - Turn-Off SOA

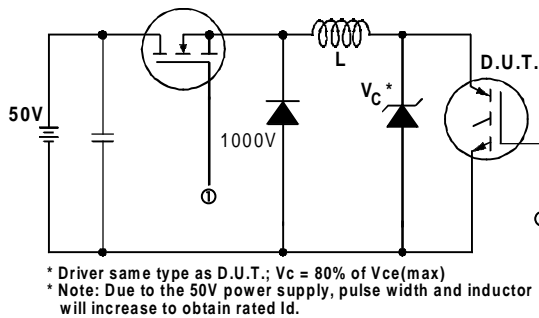

Fig. 13a - Clamped Inductive Load Test Circuit

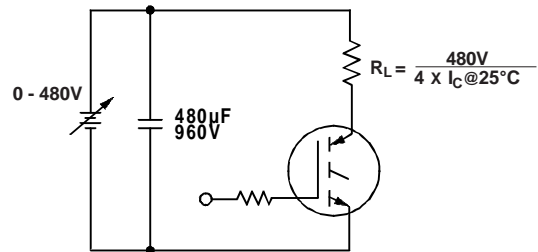

Fig. 13b - Pulsed Collector Current Test Circuit

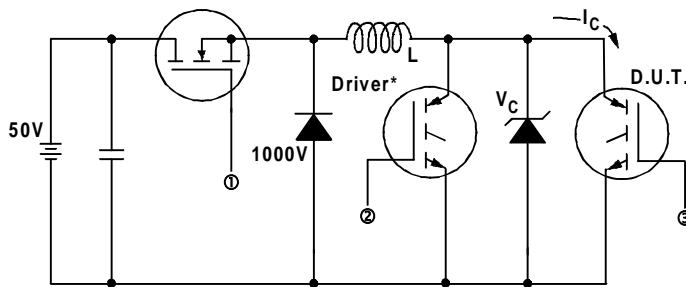

Fig. 14a - Switching Loss Test Circuit

* Driver same type as D.U.T., $V_C = 480V$

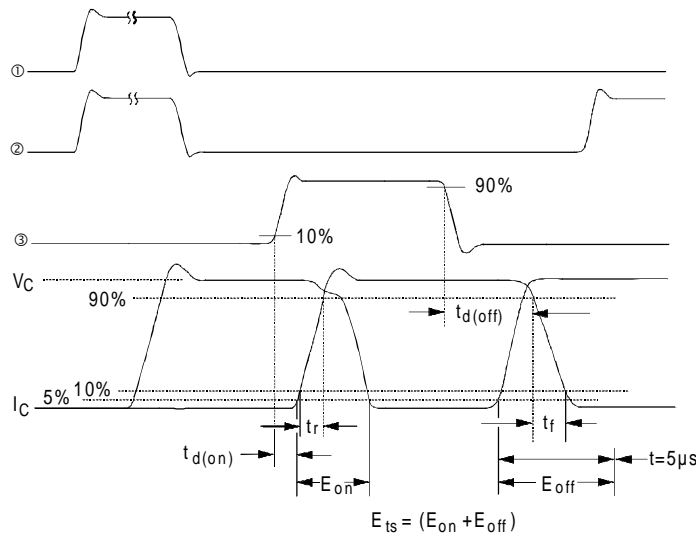
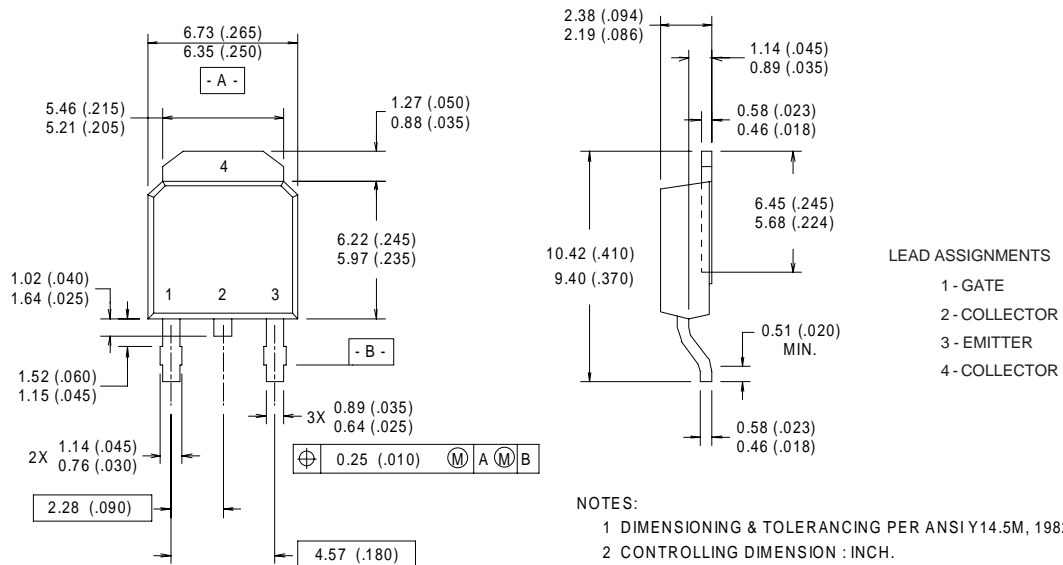

Fig. 14b - Switching Loss Waveforms

D-Pak (TO-252AA) Package Outline

Dimensions are shown in millimeters (inches)



IRG4RC20F

International
IR Rectifier

D-Pak (TO-252AA) Tape & Reel Information

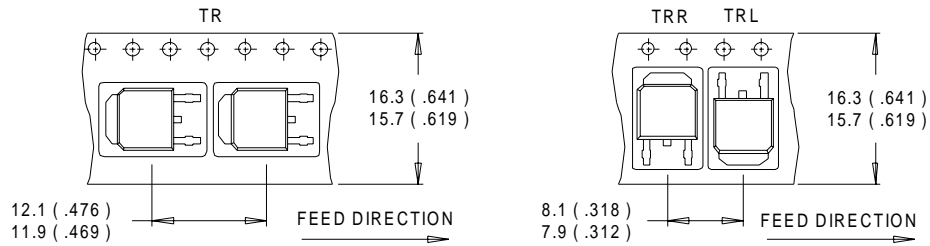

- NOTES :
1. CONTROLLING DIMENSION : MILLIMETER.
 2. ALL DIMENSIONS ARE SHOWN IN MILLIMETERS (INCHES).
 3. OUTLINE CONFORMS TO EIA-481 & EIA-541.

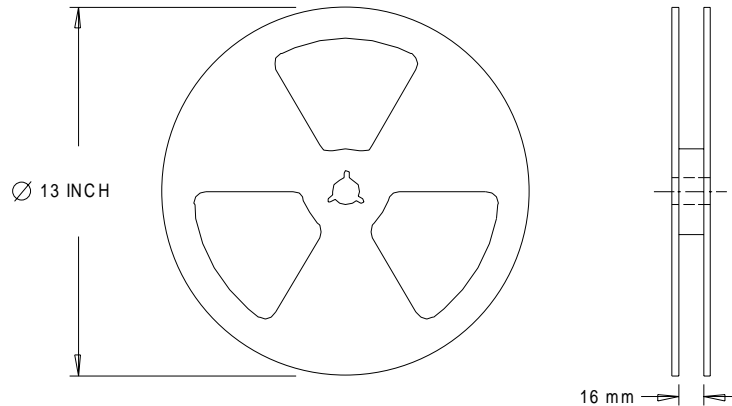

- NOTES :
1. OUTLINE CONFORMS TO EIA-481.

Data and specifications subject to change without notice.
This product has been designed and qualified for the Industrial market.
Qualification Standards can be found on IR's Web site.

International
IR Rectifier



IR WORLD HEADQUARTERS: 233 Kansas St., El Segundo, California 90245, USA Tel: (310) 252-7105
TAC Fax: (310) 252-7903

Visit us at www.irf.com for sales contact information. 2/01

Note: For the most current drawings please refer to the IR website at:
<http://www.irf.com/package/>

Looking for pricing, stock, or lifecycle information?

Click below to explore more details on WIN SOURCE:

-  [View IRG4RC20F on WIN SOURCE](#)
-  [Infineon Technologies](#) Information

Optimize Your Supply Chain with WIN SOURCE Solutions

-  Global Sourcing Solution
-  Obsolete Management
-  Cost Control Management
-  Shortage Management
-  Alternative Solution
-  Excess Inventory Management