



THE DATASHEET OF IRG4PC50KD



IRG4PC50KDPbF

INSULATED GATE BIPOLAR TRANSISTOR WITH
 ULTRAFAST SOFT RECOVERY DIODE

Short Circuit Rated
 UltraFast IGBT

Features

- Short Circuit Rated UltraFast: Optimized for high operating frequencies >5.0 kHz, and Short Circuit Rated to 10µs @125°C, $V_{GE} = 15V$
- Generation 4 IGBT design provides tighter parameter distribution and higher efficiency than Generation 3
- IGBT co-packaged with HEXFRED™ ultrafast, ultra-soft recovery anti-parallel diodes for use in bridge configurations
- Industry standard TO-247AC package
- Lead-Free

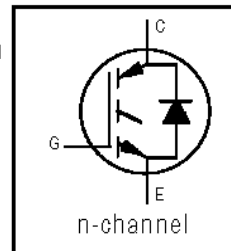

$V_{CES} = 600V$
$V_{CE(on) typ.} = 1.84V$
@ $V_{GE} = 15V, I_C = 30A$

Benefits

- Generation 4 IGBTs offer highest efficiencies available
- HEXFRED diodes optimized for performance with IGBT. Minimized recovery characteristics require less/no snub
- Designed to be a "drop-in" replacement for equivalent industry-standard Generation 3 IR IGBTs

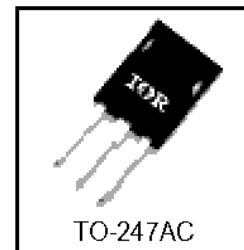

Absolute Maximum Ratings

	Parameter	Max.	Units
V_{CES}	Collector-to-Emitter Voltage	600	V
$I_C @ T_C = 25^\circ C$	Continuous Collector Current	52	A
$I_C @ T_C = 100^\circ C$	Continuous Collector Current	30	
I_{CM}	Pulsed Collector Current ①	104	
I_{LM}	Clamped Inductive Load Current ②	104	
$I_F @ T_C = 100^\circ C$	Diode Continuous Forward Current	25	
I_{FM}	Diode Maximum Forward Current	280	
t_{sc}	Short Circuit Withstand Time	10	µs
V_{GE}	Gate-to-Emitter Voltage	± 20	V
$P_D @ T_C = 25^\circ C$	Maximum Power Dissipation	200	W
$P_D @ T_C = 100^\circ C$	Maximum Power Dissipation	78	
T_J	Operating Junction and Storage Temperature Range	-55 to +150	°C
T_{STG}			
	Mounting Torque, 6-32 or M3 Screw.	10 lbf·in (1.1 N·m)	

Thermal Resistance

	Parameter	Min.	Typ.	Max.	Units
$R_{\theta JC}$	Junction-to-Case - IGBT	—	—	0.64	°C/W
$R_{\theta JC}$	Junction-to-Case - Diode	—	—	0.83	
$R_{\theta CS}$	Case-to-Sink, flat, greased surface	—	0.24	—	
$R_{\theta JA}$	Junction-to-Ambient, typical socket mount	—	—	40	
Wt	Weight	—	6 (0.21)	—	g (oz)

IRG4PC50KDPbF

International
 Rectifier

Electrical Characteristics @ T_J = 25°C (unless otherwise specified)

	Parameter	Min.	Typ.	Max.	Units	Conditions
V _{(BR)CES}	Collector-to-Emitter Breakdown Voltage ③	600	—	—	V	V _{GE} = 0V, I _C = 250μA
DV _{(BR)CES} /DT _J	Temperature Coeff. of Breakdown Voltage	—	0.47	—	V/°C	V _{GE} = 0V, I _C = 1.0mA
V _{CE(on)}	Collector-to-Emitter Saturation Voltage	—	1.84	2.2	V	I _C = 30A, V _{GE} = 15V I _C = 52A, see figures 2, 5 I _C = 25A, T _J = 150°C
		—	2.19	—		
		—	1.79	—		
V _{GE(th)}	Gate Threshold Voltage	3.0	—	6.0		V _{CE} = V _{GE} , I _C = 250μA
DV _{GE(th)} /DT _J	Temperature Coeff. of Threshold Voltage	—	-12	—	mV/°C	V _{CE} = V _{GE} , I _C = 250μA
g _{fe}	Forward Transconductance ④	17	24	—	S	V _{CE} = 100V, I _C = 30A
I _{CES}	Zero Gate Voltage Collector Current	—	—	250	μA	V _{GE} = 0V, V _{CE} = 600V V _{GE} = 0V, V _{CE} = 600V, T _J = 150°C
		—	—	6500		
V _{FM}	Diode Forward Voltage Drop	—	1.3	1.7	V	I _C = 25A, see figure 13 I _C = 25A, T _J = 150°C
		—	1.2	1.5		
I _{GES}	Gate-to-Emitter Leakage Current	—	—	±100	nA	V _{GE} = ±20V

Switching Characteristics @ T_J = 25°C (unless otherwise specified)

	Parameter	Min.	Typ.	Max.	Units	Conditions
Q _g	Total Gate Charge (turn-on)	—	200	300	nC	I _C = 30A V _{CC} = 400V, see figure 8 V _{GE} = 15V
Q _{ge}	Gate - Emitter Charge (turn-on)	—	25	38		
Q _{gc}	Gate - Collector Charge (turn-on)	—	85	127		
t _{d(on)}	Turn-On Delay Time	—	63	—	ns	T _J = 25°C I _C = 30A, V _{CC} = 480V V _{GE} = 15V, R _G = 5.0Ω
t _r	Rise Time	—	49	—		
t _{d(off)}	Turn-Off Delay Time	—	150	220		
t _f	Fall Time	—	95	140		
E _{on}	Turn-On Switching Loss	—	1.61	—	mJ	Energy losses include "tail" and diode reverse recovery
E _{off}	Turn-Off Switching Loss	—	0.84	—		
E _{ts}	Total Switching Loss	—	2.45	3.0		
t _{sc}	Short Circuit Withstand Time	10	—	—	μs	V _{CC} = 360V, T _J = 125°C V _{GE} = 15V, R _G = 10Ω, V _{CPK} < 500V
t _{d(on)}	Turn-On Delay Time	—	61	—	ns	T _J = 150°C, see figures 11,18 I _C = 30A, V _{CC} = 480V V _{GE} = 15V, R _G = 5.0Ω
t _r	Rise Time	—	46	—		
t _{d(off)}	Turn-Off Delay Time	—	310	—		
t _f	Fall Time	—	170	—		
E _{ts}	Total Switching Loss	—	3.53	—	mJ	Energy losses include "tail" and diode reverse recovery
L _E	Internal Emitter Inductance	—	13	—	nH	Measured 5mm from package
C _{ies}	Input Capacitance	—	3200	—	pF	V _{GE} = 0V V _{CC} = 30V, see figure 7 f = 1.0MHz
C _{oes}	Output Capacitance	—	370	—		
C _{res}	Reverse Transfer Capacitance	—	95	—		
t _{rr}	Diode Reverse Recovery Time	—	50	75	ns	T _J = 25°C, see figure 14 T _J = 125°C, 14
		—	105	160		
I _{rr}	Diode Peak Reverse Recovery Current	—	4.5	10	A	T _J = 25°C, see figure 15 T _J = 125°C, 15
		—	8.0	15		
Q _{rr}	Diode Reverse Recovery Charge	—	112	375	nC	T _J = 25°C, see figure 16 T _J = 125°C, 16
		—	420	1200		
di _(rec) /dt	Diode Peak Rate of Fall of Recovery During t _b	—	250	—	A/μs	T _J = 25°C, see figure 17 T _J = 125°C, 17
		—	160	—		

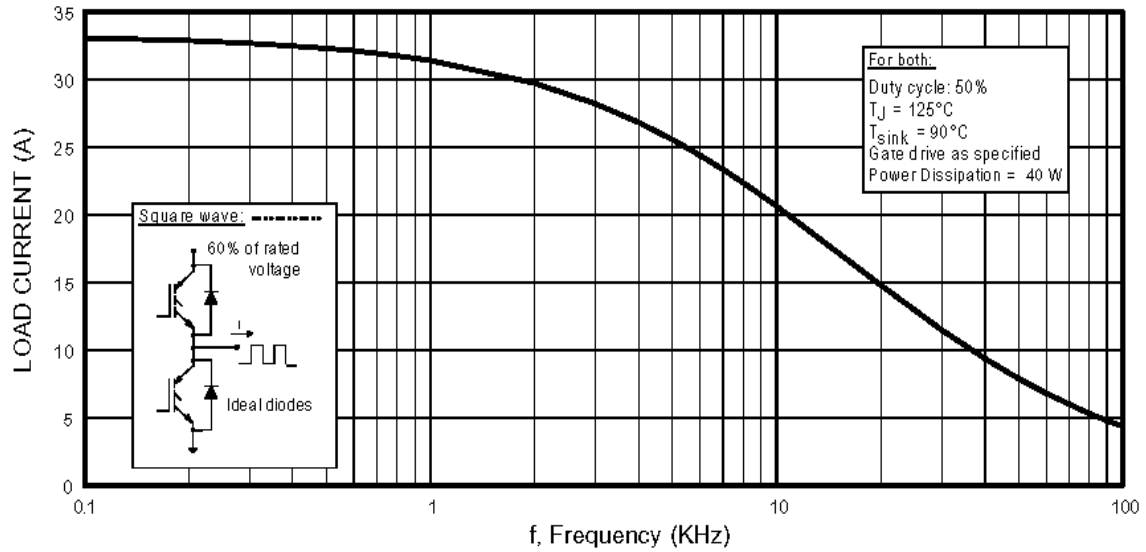

Fig. 1 - Typical Load Current vs. Frequency
 (Load Current = I_{RMS} of fundamental)

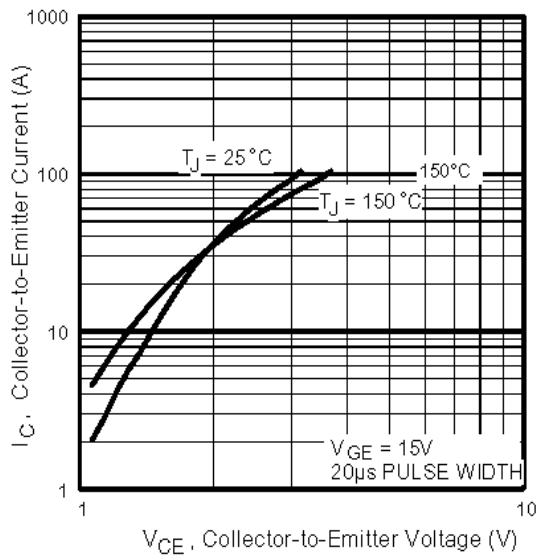

Fig. 2 - Typical Output Characteristics

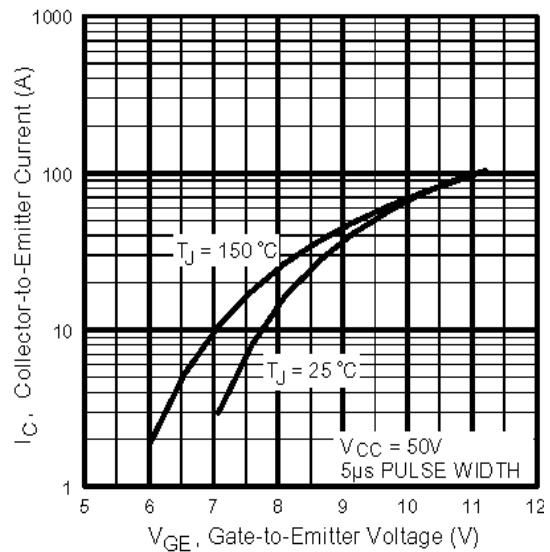

Fig. 3 - Typical Transfer Characteristics

IRG4PC50KDPbF

International
IR Rectifier

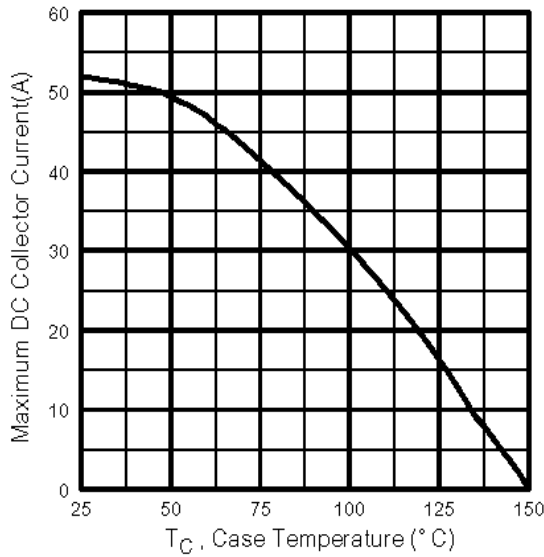

Fig. 4 - Maximum Collector Current vs. Case Temperature

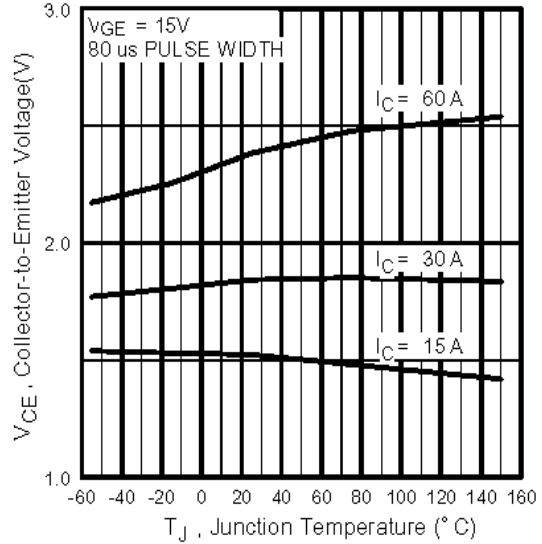

Fig. 5 - Typical Collector-to-Emitter Voltage vs. Junction Temperature

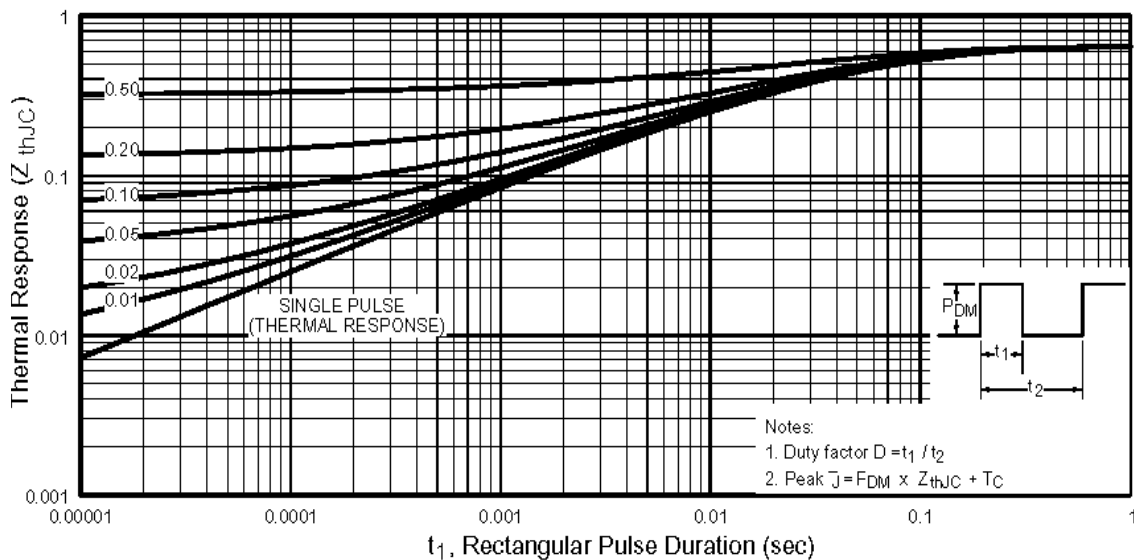

Fig. 6 - Maximum Effective Transient Thermal Impedance, Junction-to-Case

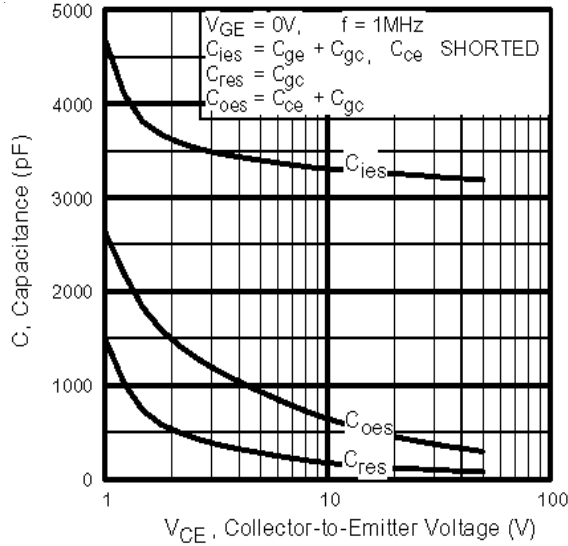

Fig. 7 - Typical Capacitance vs. Collector-to-Emitter Voltage

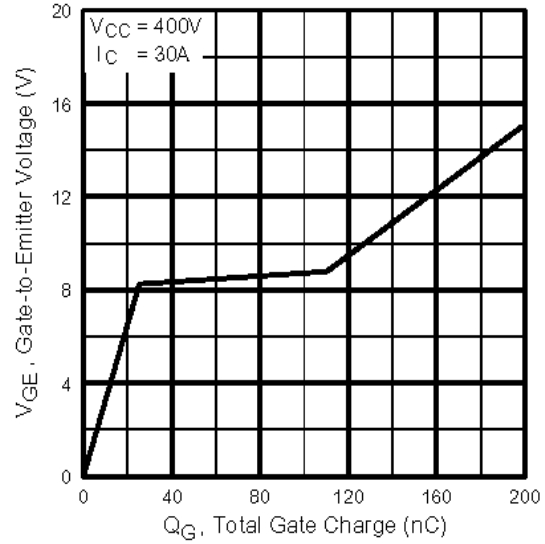

Fig. 8 - Typical Gate Charge vs. Gate-to-Emitter Voltage

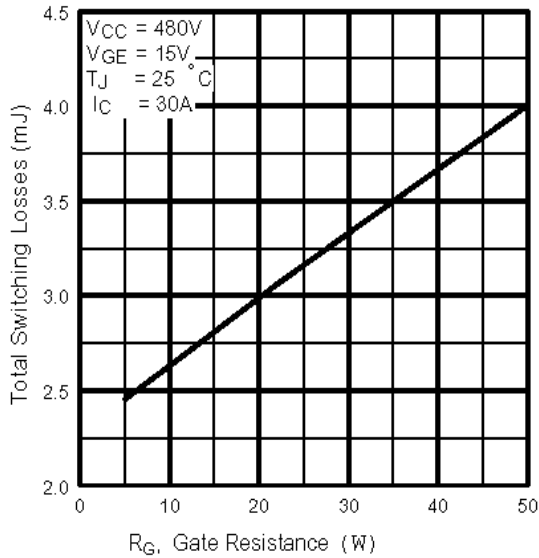

Fig. 9 - Typical Switching Losses vs. Gate Resistance

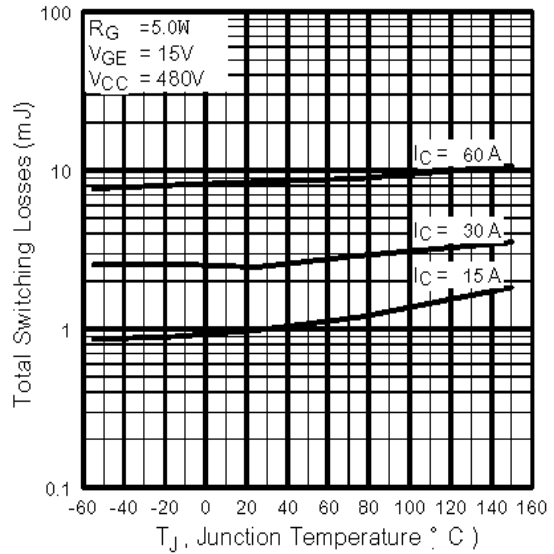

Fig. 10 - Typical Switching Losses vs. Junction Temperature

IRG4PC50KDPbF

International
IR Rectifier

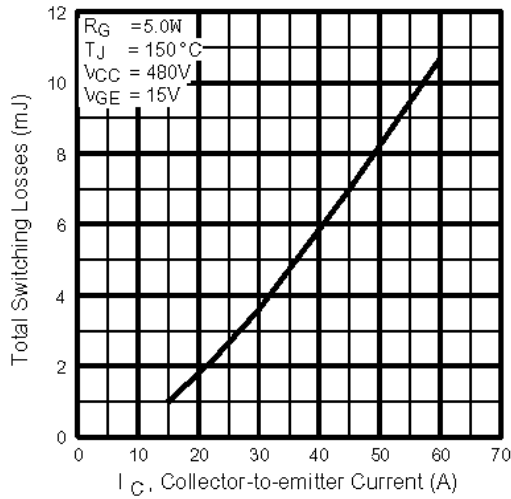

Fig. 11 - Typical Switching Losses vs. Collector-to-Emitter Current

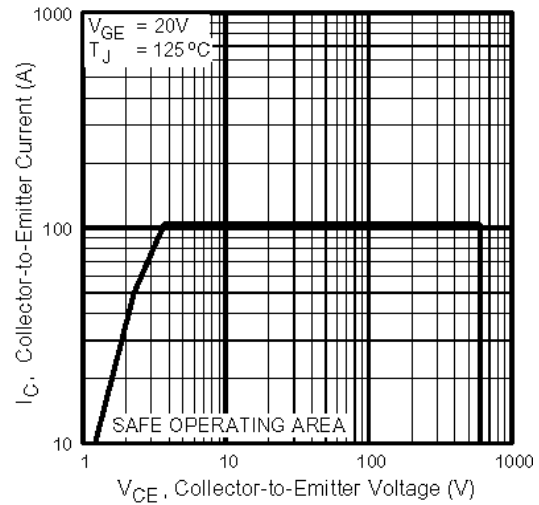

Fig. 12 - Turn-Off SOA

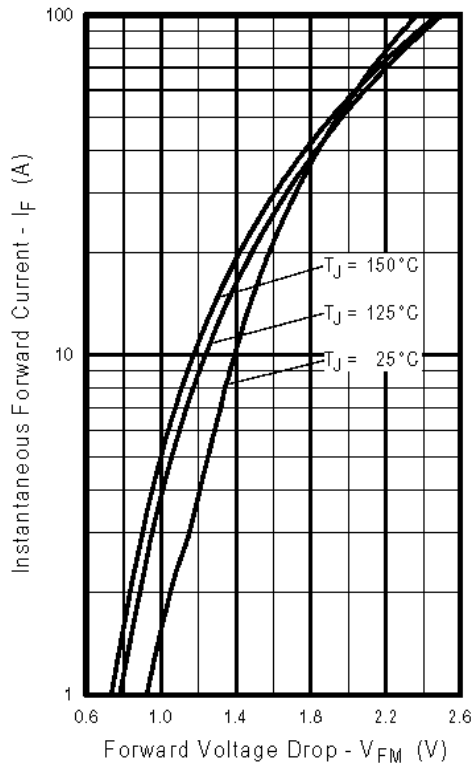

Fig. 13 - Maximum Forward Voltage Drop vs. Instantaneous Forward Current

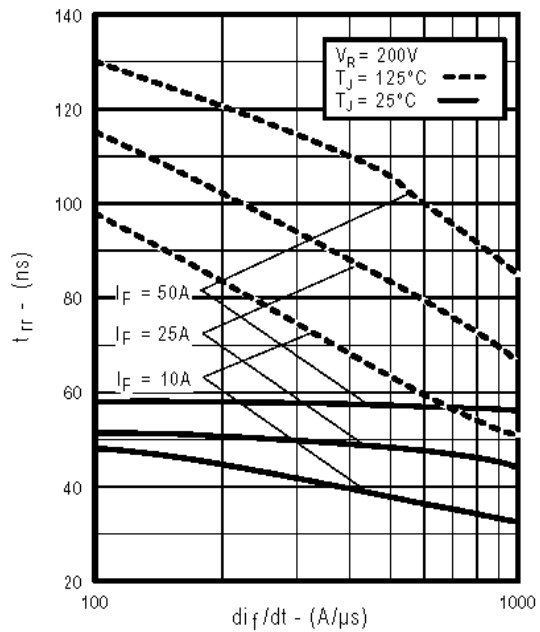

Fig. 14 - Typical Reverse Recovery vs. di_f/dt

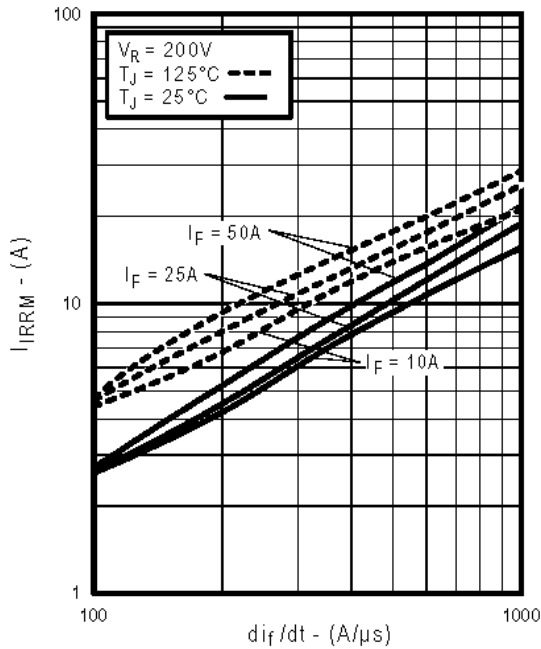

Fig. 15 - Typical Recovery Current vs. di_f/dt

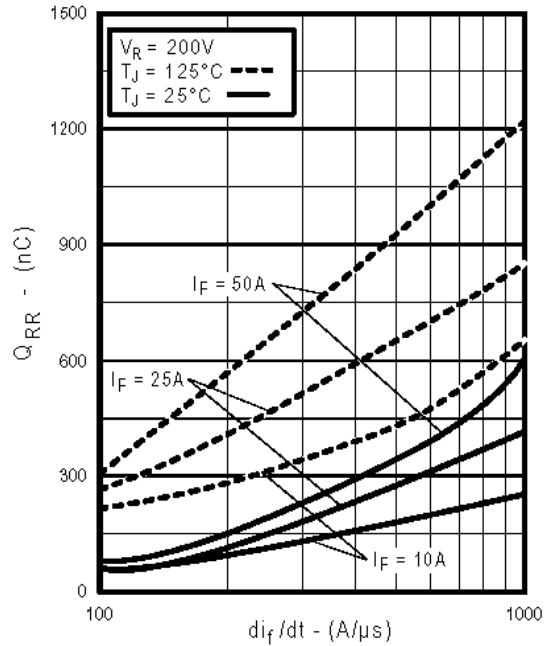

Fig. 16 - Typical Stored Charge vs. di_f/dt

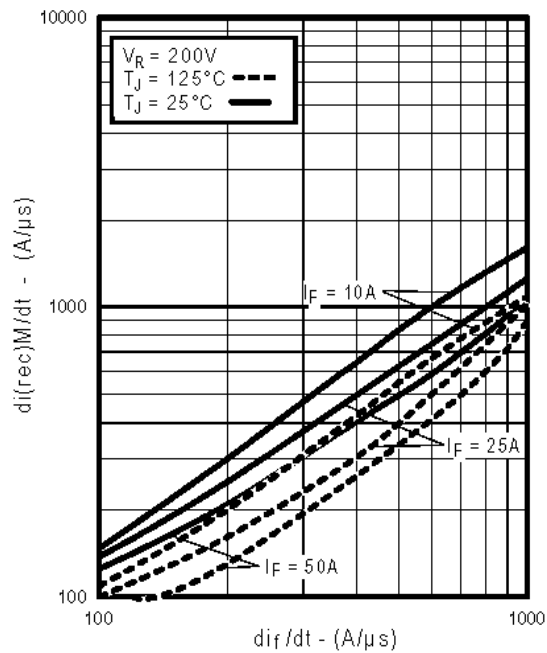

Fig. 17 - Typical $di_{(rec)M}/dt$ vs. di_f/dt

Mechanical drawings, Appendix A
Test Circuit diagrams, Appendix B
Switching Loss Waveforms, Appendix C

IRG4PC50KDPbF

International
IR Rectifier

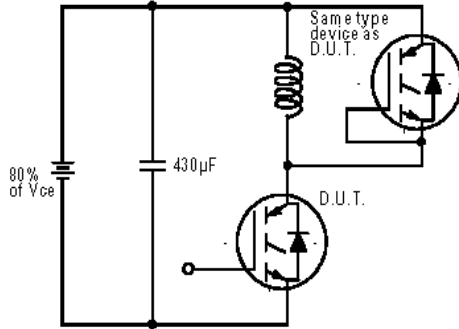

Fig. 18a - Test Circuit for Measurement of I_{LM} , E_{on} , $E_{off}(\text{diode})$, t_{rr} , Q_{rr} , I_{rr} , $t_{d(on)}$, t_r , $t_{d(off)}$, t_f

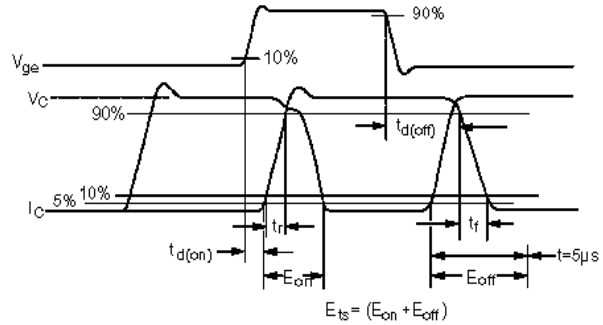

Fig. 18b - Test Waveforms for Circuit of Fig. 18a, Defining E_{off} , $t_{d(off)}$, t_f

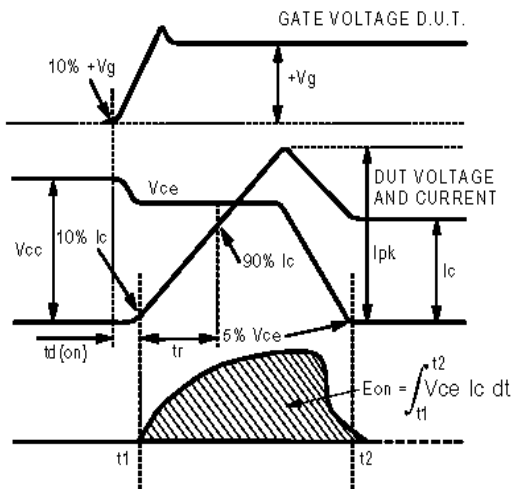

Fig. 18c - Test Waveforms for Circuit of Fig. 18a, Defining E_{on} , $t_{d(on)}$, t_r

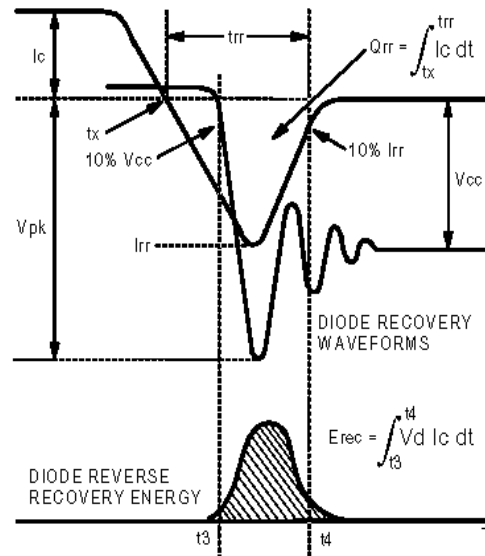

Fig. 18d - Test Waveforms for Circuit of Fig. 18a, Defining E_{rec} , t_{rr} , Q_{rr} , I_{rr}

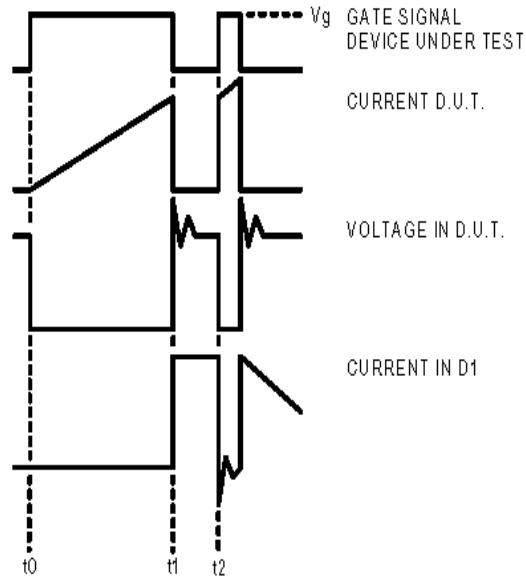

Figure 18e. Macro Waveforms for Figure 18a's Test Circuit

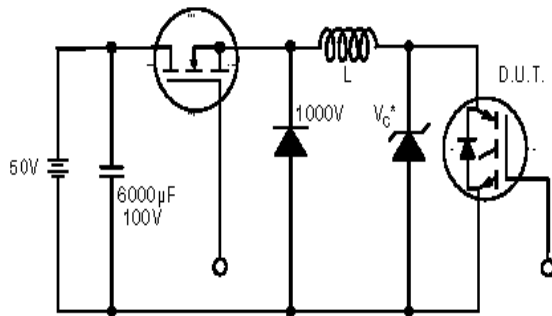

Figure 19. Clamped Inductive Load Test Circuit

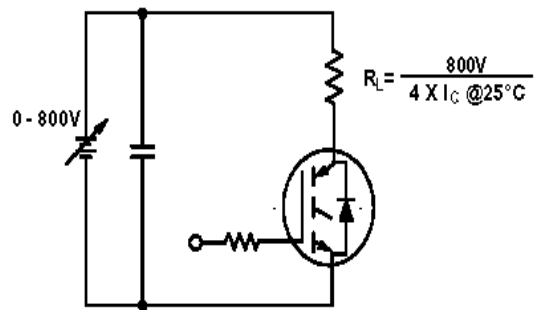

Figure 20. Pulsed Collector Current Test Circuit

IRG4PC50KDPbF

International
IR Rectifier

TO-247AC Package Outline

Dimensions are shown in millimeters (inches)

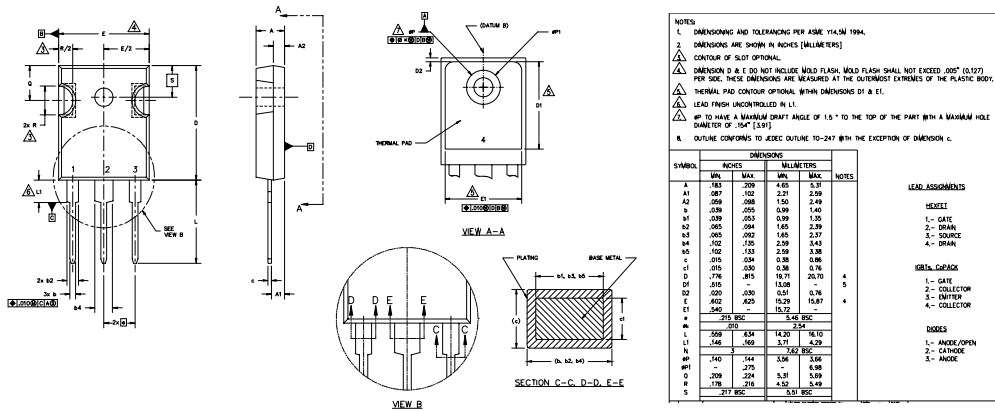

TO-247AC Part Marking Information

EXAMPLE: THIS IS AN IRFP30
WITH ASSEMBLY
LOT CODE 5657
ASSEMBLED ON WW 35, 2000
IN THE ASSEMBLY LINE "H"

Note: "P" in assembly line
position indicates "Lead-Free"

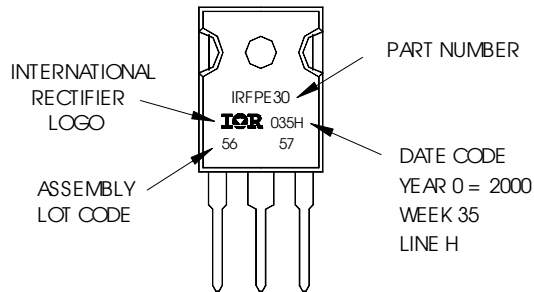

Data and specifications subject to change without notice.

International
IR Rectifier

IR WORLD HEADQUARTERS: 233 Kansas St., El Segundo, California 90245, USA Tel: (310) 252-7105

TAC Fax: (310) 252-7903

Visit us at www.irf.com for sales contact information. 05/04

www.irf.com

Note: For the most current drawings please refer to the IR website at:
<http://www.irf.com/package/>

Looking for pricing, stock, or lifecycle information?

Click below to explore more details on WIN SOURCE:

 [View IRG4PC50KD on WIN SOURCE](#)

 [Infineon Technologies](#) Information

Optimize Your Supply Chain with WIN SOURCE Solutions

-  Global Sourcing Solution
-  Obsolete Management
-  Cost Control Management
-  Shortage Management
-  Alternative Solution
-  Excess Inventory Management