



**THE DATASHEET OF
IRG4BC30FD-SPBF**



International IR Rectifier

INSULATED GATE BIPOLAR TRANSISTOR WITH
HYPERFAST DIODE

PD - 95970A

IRG4BC30FD-SPbF

Fast CoPack IGBT

Features

- Fast: optimized for medium operating frequencies (1-5 kHz in hard switching, >20kHz in resonant mode).
- Generation 4 IGBT design provides tighter parameter distribution and higher efficiency than Generation 3.
- IGBT co-packaged with HEXFRED™ ultrafast, ultra-soft recovery anti-parallel diodes for use in bridge configurations.
- Lead-Free

Benefits

- Generation 4 IGBT's offer highest efficiency available.
- IGBT's optimized for specific application conditions.
- HEXFRED diodes optimized for performance with IGBT's. Minimized recovery characteristics require less/no snubbing.
- Designed to be a "drop-in" replacement for equivalent industry-standard Generation 3 IR IGBT's.

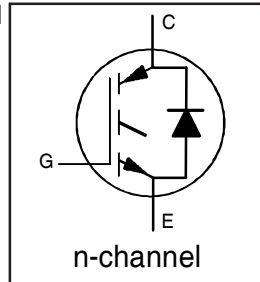

$V_{CES} = 600V$
 $V_{CE(on) \text{ typ.}} = 1.59V$
 @ $V_{GE} = 15V, I_C = 17A$



Absolute Maximum Ratings

	Parameter	Max.	Units
V_{CES}	Collector-to-Emitter Voltage	600	V
$I_C @ T_C = 25^\circ C$	Continuous Collector Current	31	A
$I_C @ T_C = 100^\circ C$	Continuous Collector Current	17	
I_{CM}	Pulse Collector Current (Ref.Fig.C.T.5) ①	124	
I_{LM}	Clamped Inductive Load current ②	124	
$I_F @ T_C = 100^\circ C$	Diode Continuous Forward Current	12	
I_{FM}	Diode Maximum Forward Current	120	
V_{GE}	Gate-to-Emitter Voltage	± 20	V
$P_D @ T_C = 25^\circ C$	Maximum Power Dissipation	100	W
$P_D @ T_C = 100^\circ C$	Maximum Power Dissipation	42	
T_J	Operating Junction and	-55 to +150	$^\circ C$
T_{STG}	Storage Temperature Range		

Thermal / Mechanical Characteristics

	Parameter	Min.	Typ.	Max.	Units
$R_{\theta JC}$	Junction-to-Case- IGBT	—	—	1.2	$^\circ C/W$
$R_{\theta CS}$	Case-to-Sink, flat, greased surface	—	0.50	—	
$R_{\theta JA}$	Junction-to-Ambient (PCB Mounted, steady state) ③	—	—	40	
Wt	Weight	—	2.0 (0.07)	—	g (oz.)

IRG4BC30FD-SPbF

International
IR Rectifier

Electrical Characteristics @ T_J = 25°C (unless otherwise specified)

	Parameter	Min.	Typ.	Max.	Units	Conditions
V _{(BR)CES}	Collector-to-Emitter Breakdown Voltage ③	600	—	—	V	V _{GE} = 0V, I _C = 250μA
ΔV _{(BR)CES} /ΔT _J	Temperature Coeff. of Breakdown Voltage	—	0.69	—	V/°C	V _{GE} = 0V, I _C = 1mA
V _{CE(on)}	Collector-to-Emitter Voltage	—	1.59	1.8	V	I _C = 17A V _{GE} = 15V
		—	1.99	—		I _C = 31A See Fig. 2, 5
		—	1.7	—		I _C = 17A, T _J = 150°C
V _{GE(th)}	Gate Threshold Voltage	3.0	—	6.0	V	V _{CE} = V _{GE} , I _C = 250μA
ΔV _{GE(th)} /ΔT _J	Threshold Voltage temp. coefficient	—	-11	—	mV/°C	V _{CE} = V _{GE} , I _C = 250μA
g _{fe}	Forward Transconductance ④	6.1	10	—	S	V _{CE} = 100V, I _C = 17A
I _{CES}	Zero Gate Voltage Collector Current	—	—	250	μA	V _{GE} = 0V, V _{CE} = 600V
		—	—	2500		V _{GE} = 0V, V _{CE} = 600V, T _J = 150°C
V _{FM}	Diode Forward Voltage Drop	—	1.4	1.7	V	I _F = 12A See Fig. 13
		—	1.3	1.6		I _F = 12A, T _J = 150°C
I _{GES}	Gate-to-Emitter Leakage Current	—	—	±100	nA	V _{GE} = ±20V

Switching Characteristics @ T_J = 25°C (unless otherwise specified)

	Parameter	Min.	Typ.	Max.	Units	Conditions
Q _g	Total Gate Charge (turn-on)	—	51	77	nC	I _C = 17A
Q _{ge}	Gate-to-Emitter Charge (turn-on)	—	7.9	12		V _{CC} = 400V See Fig. 8
Q _{gc}	Gate-to-Collector Charge (turn-on)	—	19	28		V _{GE} = 15V
t _{d(on)}	Turn-On delay time	—	42	—	ns	T _J = 25°C
t _r	Rise time	—	26	—		I _C = 17A, V _{CC} = 480V
t _{d(off)}	Turn-Off delay time	—	230	350		V _{GE} = 15V, R _G = 23Ω
t _f	Fall time	—	160	230		Energy losses include "tail" and diode reverse recovery.
E _{on}	Turn-On Switching Loss	—	0.63	—	mJ	See Fig. 9, 10, 11, 18
E _{off}	Turn-Off Switching Loss	—	1.39	—		
E _{ts}	Total Switching Loss	—	2.02	3.9		
t _{d(on)}	Turn-On delay time	—	42	—	ns	T _J = 150°C See Fig. 9,10,11,18
t _r	Rise time	—	27	—		I _C = 17A, V _{CC} = 480V
t _{d(off)}	Turn-Off delay time	—	310	—		V _{GE} = 15V, R _G = 23Ω
t _f	Fall time	—	310	—		Energy losses include "tail" and diode reverse recovery.
E _{ts}	Total Switching Loss	—	3.2	—	mJ	
L _E	Internal Emitter Inductance	—	7.5	—	nH	Measured 5mm from package
C _{ies}	Input Capacitance	—	1100	—	pF	V _{GE} = 0V
C _{oes}	Output Capacitance	—	74	—		V _{CC} = 30V See Fig. 7
C _{res}	Reverse Transfer Capacitance	—	14	—		f = 1.0MHz
t _{rr}	Diode Reverse Recovery Time	—	42	60	ns	T _J = 25°C See Fig. 14
		—	80	120		T _J = 125°C
I _{rr}	Diode Peak Reverse Recovery Current	—	3.5	6.0	A	T _J = 25°C See Fig. 15
		—	5.6	10		T _J = 125°C
Q _{rr}	Diode Reverse Recovery Charge	—	80	180	nC	T _J = 25°C See Fig. 16
		—	220	600		T _J = 125°C
di _(rec) /dt	Diode Peak Rate of Fall of Recovery During t _b	—	180	—	A/μs	T _J = 25°C See Fig. 17
		—	120	—		T _J = 125°C

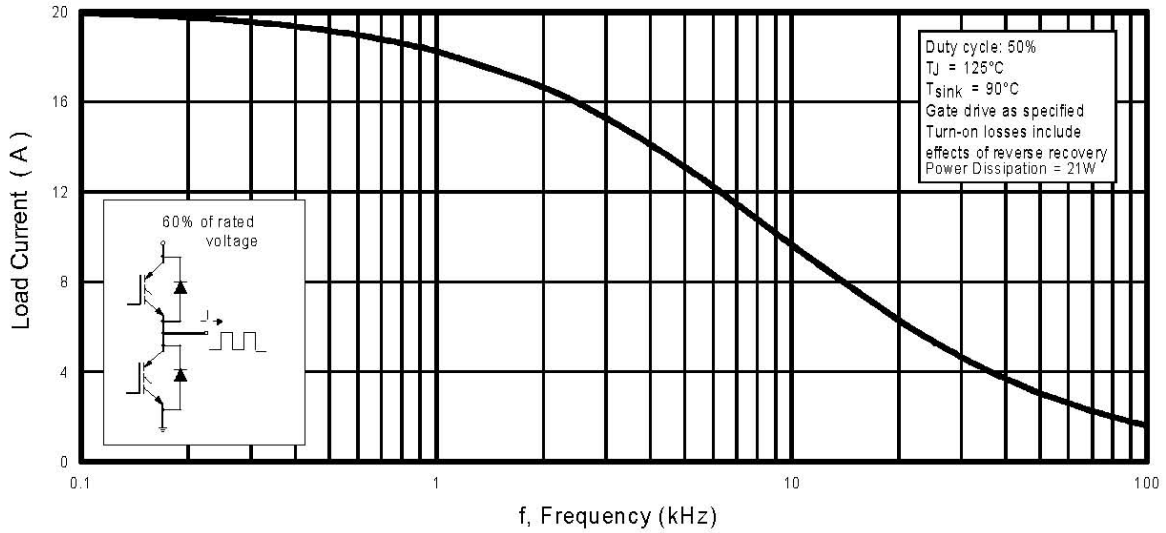

Fig. 1 - Typical Load Current vs. Frequency
 (Load Current = I_{RMS} of fundamental)

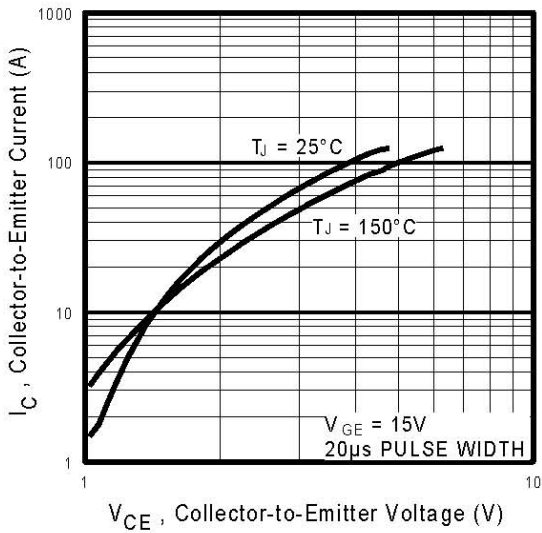

Fig. 2 - Typical Output Characteristics

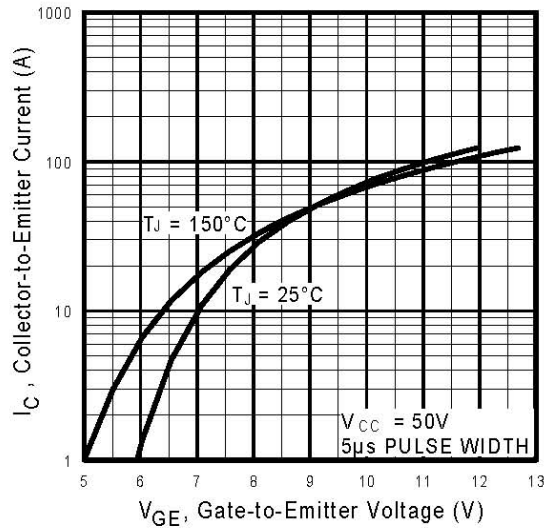

Fig. 3 - Typical Transfer Characteristics

IRG4BC30FD-SPbF

International
IR Rectifier

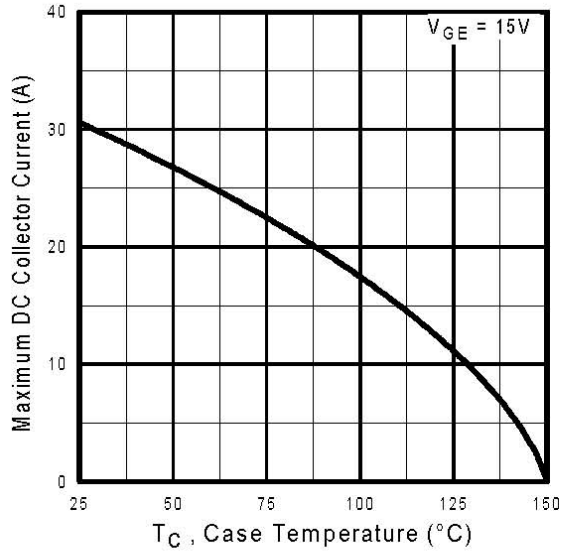

Fig. 4 - Maximum Collector Current vs. Case Temperature

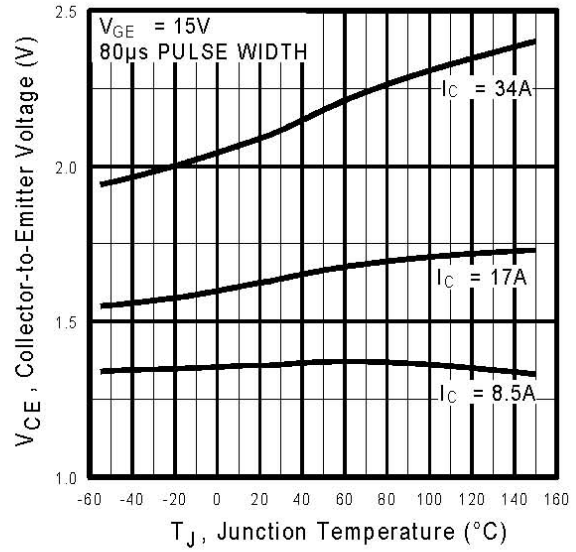

Fig. 5 - Typical Collector-to-Emitter Voltage vs. Junction Temperature

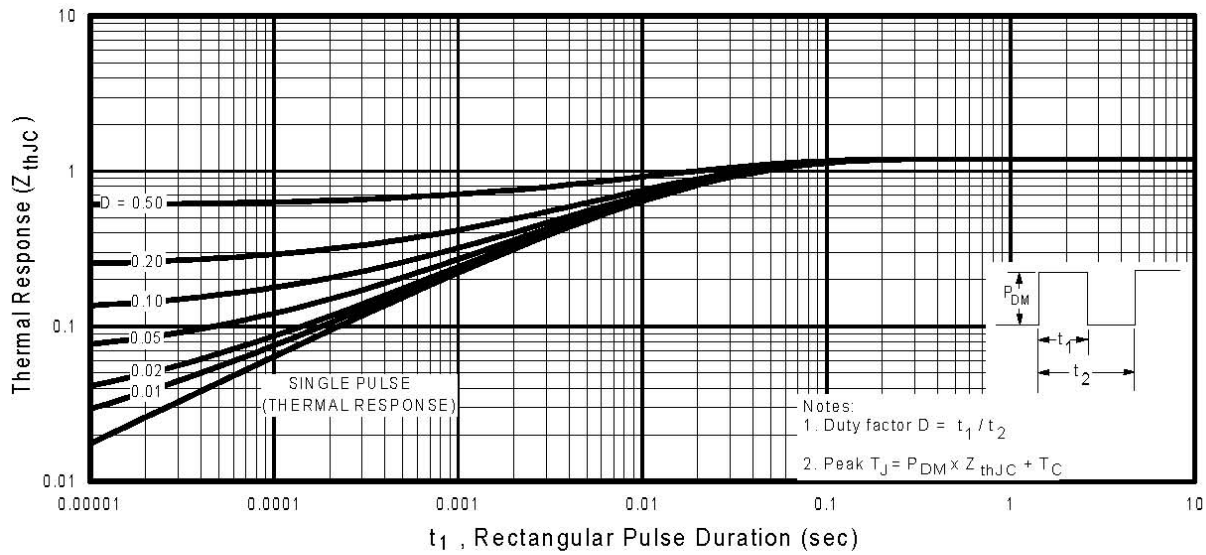

Fig. 6 - Maximum Effective Transient Thermal Impedance, Junction-to-Case

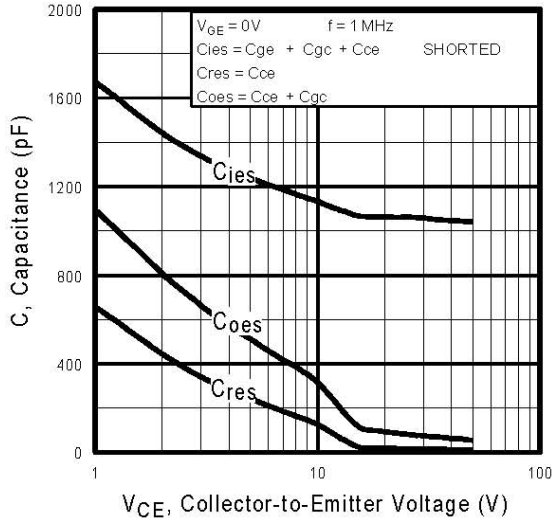

Fig. 7 - Typical Capacitance vs. Collector-to-Emitter Voltage

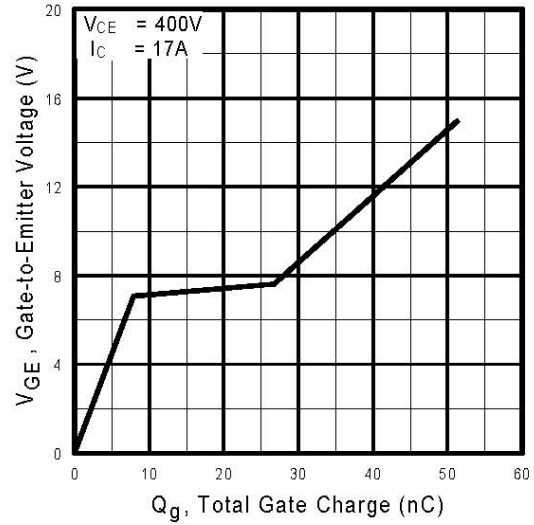

Fig. 8 - Typical Gate Charge vs. Gate-to-Emitter Voltage

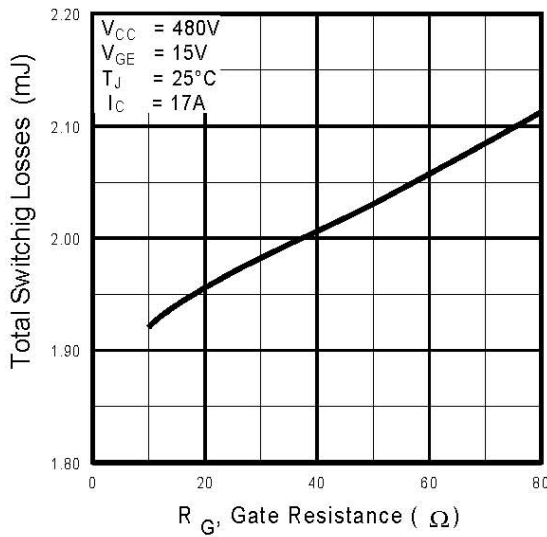

Fig. 9 - Typical Switching Losses vs. Gate Resistance

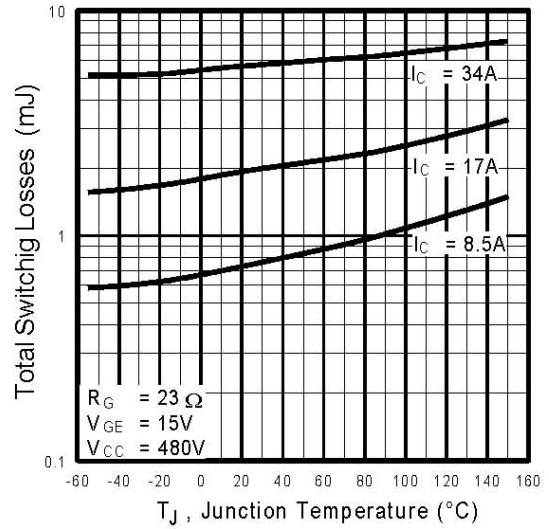

Fig. 10 - Typical Switching Losses vs. Junction Temperature

IRG4BC30FD-SPbF

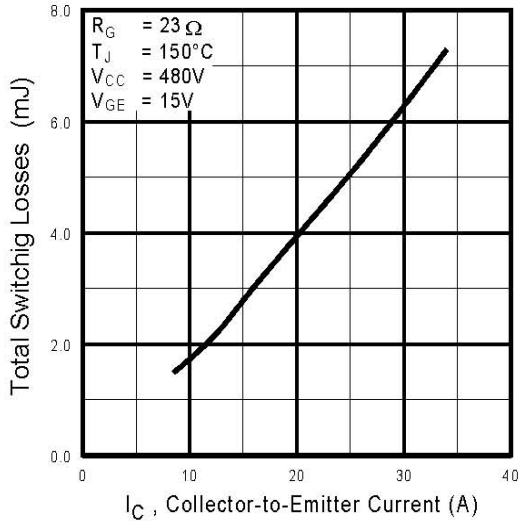

Fig. 11 - Typical Switching Losses vs. Collector-to-Emitter Current

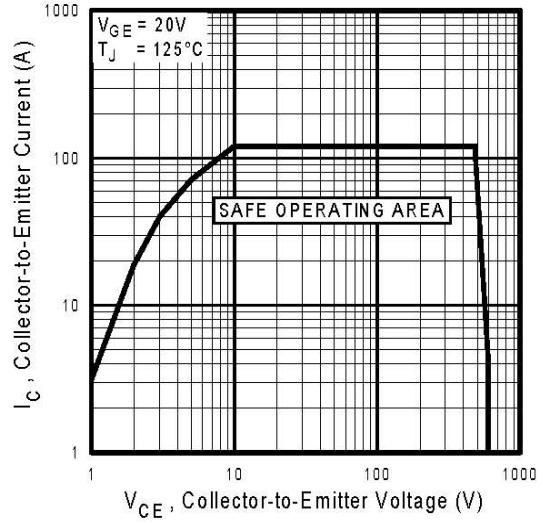

Fig. 12 - Turn-Off SOA

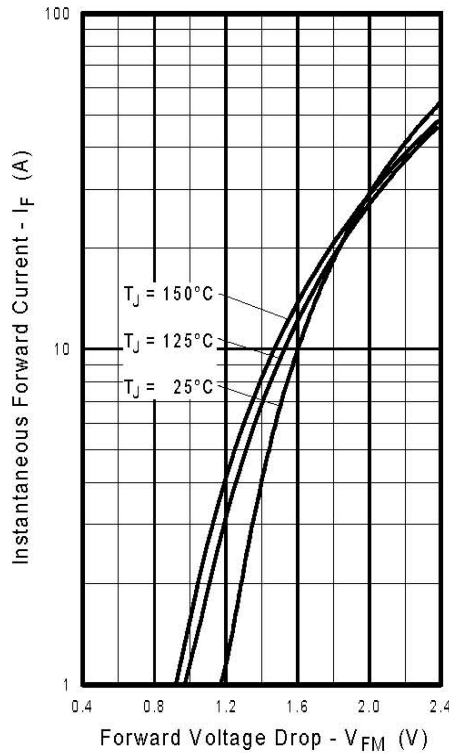

Fig. 13 - Maximum Forward Voltage Drop vs. Instantaneous Forward Current

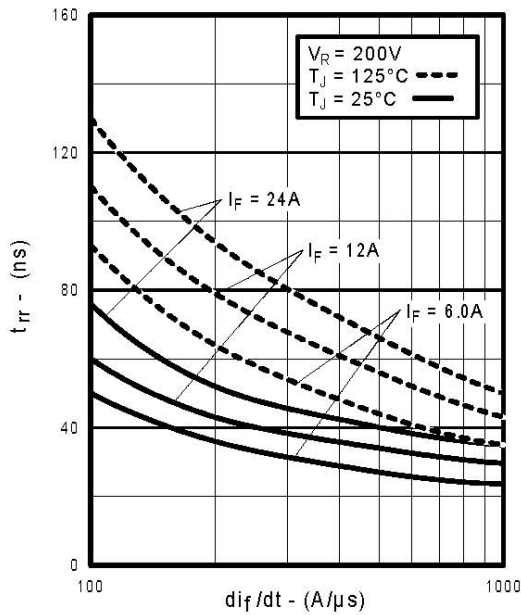

Fig. 14 - Typical Reverse Recovery vs. di_f/dt

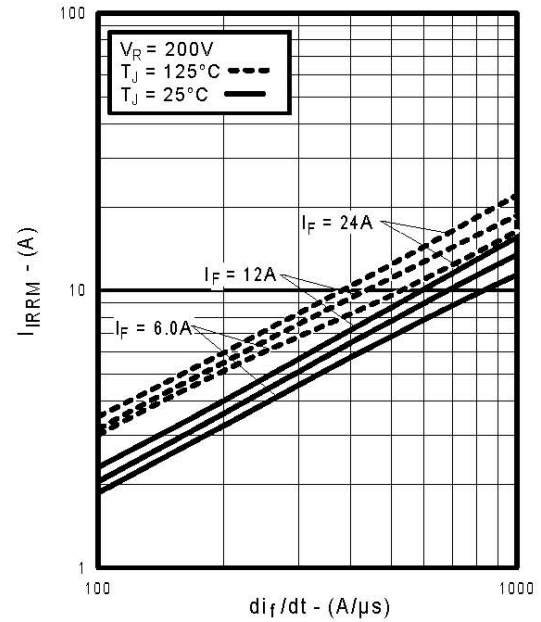

Fig. 15 - Typical Recovery Current vs. di_f/dt

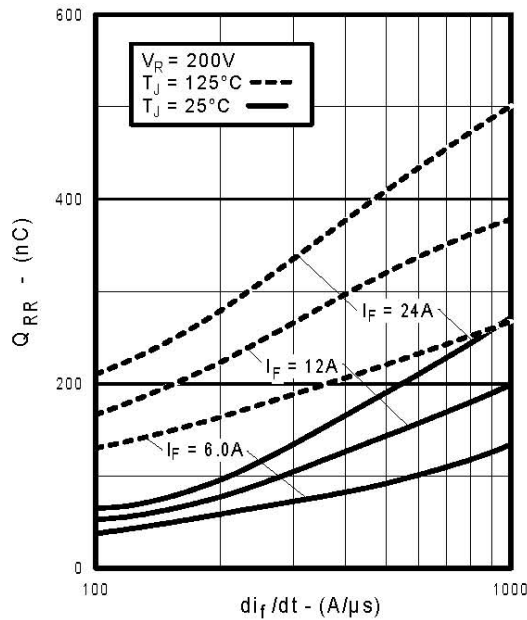

Fig. 16 - Typical Stored Charge vs. di_f/dt

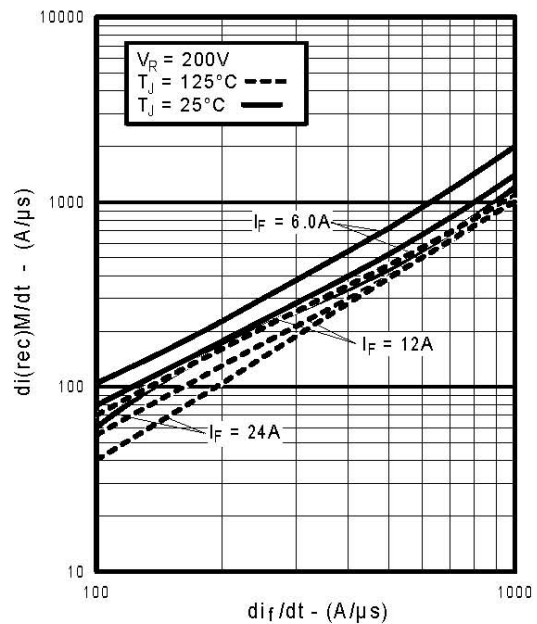

Fig. 17 - Typical $di_{(rec)M}/dt$ vs. di_f/dt

IRG4BC30FD-SPbF

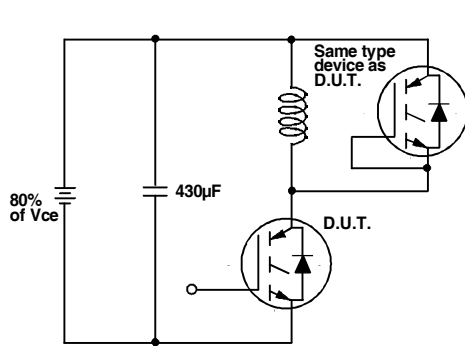

Fig. 18a - Test Circuit for Measurement of I_{LM} , E_{on} , $E_{off(diode)}$, t_{rr} , Q_{rr} , I_{rr} , $t_{d(on)}$, t_r , $t_{d(off)}$, t_f

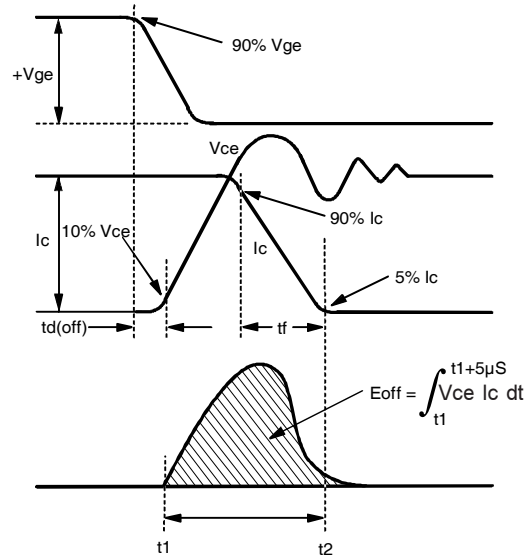

Fig. 18b - Test Waveforms for Circuit of Fig. 18a, Defining E_{off} , $t_{d(off)}$, t_f

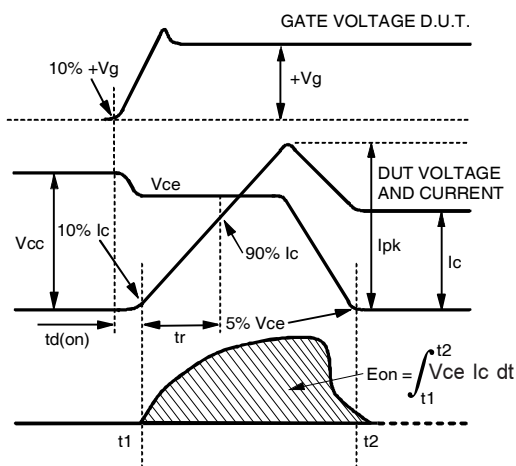

Fig. 18c - Test Waveforms for Circuit of Fig. 18a, Defining E_{on} , $t_{d(on)}$, t_r

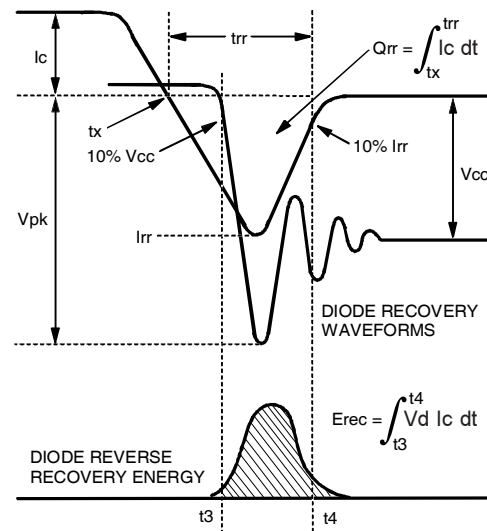

Fig. 18d - Test Waveforms for Circuit of Fig. 18a, Defining E_{rec} , t_{rr} , Q_{rr} , I_{rr}

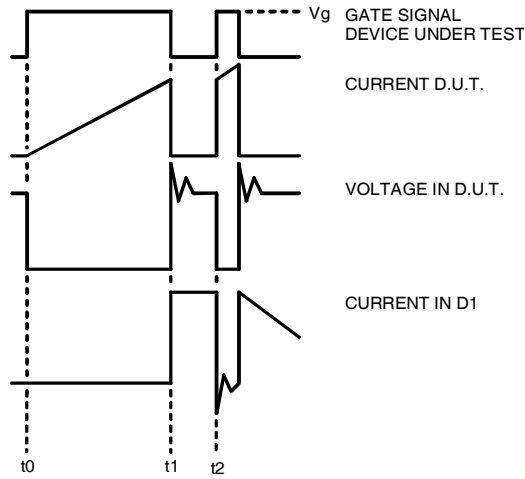

Fig.18e - Macro Waveforms for Figure 18a's Test Circuit

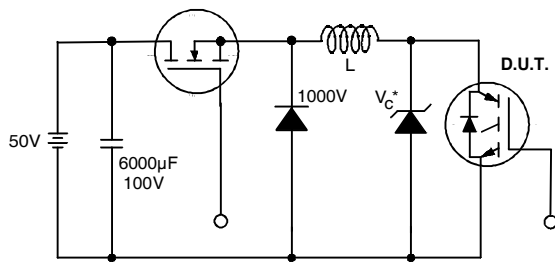
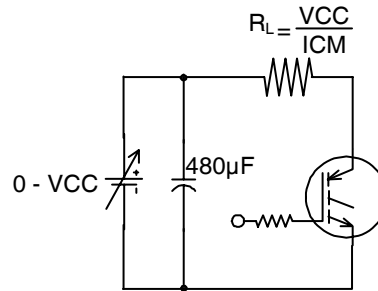

Fig. 19 - Clamped Inductive Load Test Circuit



Pulsed Collector Current
 Test Circuit

Fig. 20 - Pulsed Collector Current
 Test Circuit

IRG4BC30FD-SPbF



D²Pak Package Outline

Dimensions are shown in millimeters (inches)

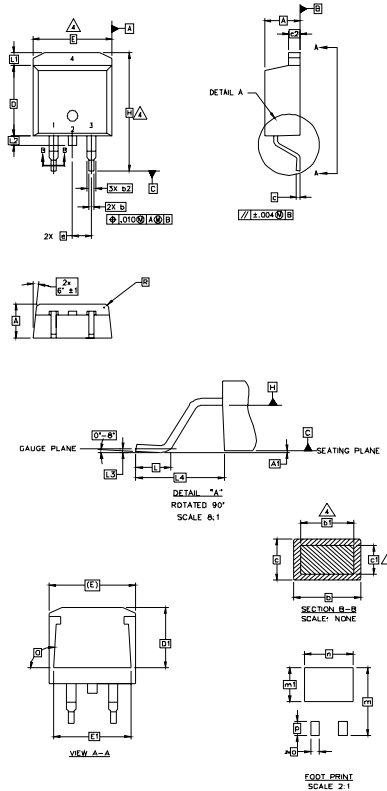

NOTES:

1. DIMENSIONING AND TOLERANCING PER ASME Y14.5M-1994
2. DIMENSIONS ARE SHOWN IN MILLIMETERS [INCHES].
3. DIMENSION D & E DO NOT INCLUDE MOLD FLASH. MOLD FLASH SHALL NOT EXCEED 0.127 [0.005"] PER SIDE. THESE DIMENSIONS ARE MEASURED AT THE OUTMOST EXTREMES OF THE PLASTIC BODY.
4. DIMENSION b1 AND c1 APPLY TO BASE METAL ONLY.
5. CONTROLLING DIMENSION: INCH.

SYMBOL	DIMENSIONS				NOTES
	MILLIMETERS		INCHES		
	MIN.	MAX.	MIN.	MAX.	
A	4.06	4.83	.160	.190	
A1	0.00	0.254	.000	.010	
b	0.51	0.99	.020	.039	4
b1	0.51	0.89	.020	.035	
b2	1.14	1.78	.045	.070	
c	0.38	0.74	.015	.029	
c1	0.38	0.58	.015	.023	4
c2	1.14	1.65	.045	.065	
D	8.51	9.65	.335	.380	3
D1	6.86		.270		
E	9.65	10.67	.380	.420	3
E1	6.22		.245		
e	2.54 BSC		.100 BSC		
H	14.61	15.88	.575	.625	
L	1.78	2.79	.070	.110	
L1		1.65	.065		
L2	1.27	1.78	.050	.070	
L3	0.25 BSC		.010 BSC		
L4	4.78	5.28	.188	.208	
m	17.78		.700		
m1	8.89		.350		
n	11.43		.450		
o	2.08		.082		
p	3.81		.150		
R	0.51	0.71	.020	.028	
theta	90°	93°	90°	93°	

LEAD ASSIGNMENTS

HEXFET

- 1.- GATE
- 2, 4.- DRAIN
- 3.- SOURCE

IGBTs, CoPACK

- 1.- GATE
- 2, 4.- COLLECTOR
- 3.- EMITTER

DIODES

- 1.- ANODE *
- 2, 4.- CATHODE
- 3.- ANODE

* PART DEPENDENT.

D²Pak Part Marking Information

EXAMPLE: THIS IS AN IRF530S WITH
LOT CODE 8024
ASSEMBLED ON WW 02, 2000
IN THE ASSEMBLY LINE 'L'

Note: "P" in assembly line position
indicates "Lead - Free"

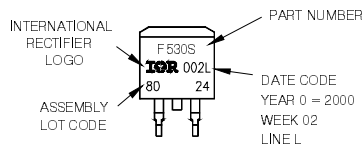

OR

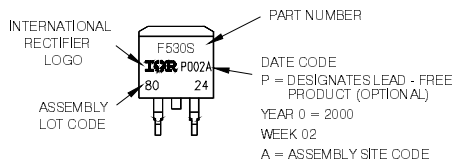

Note: For the most current drawing please refer to IR website at <http://www.irf.com/package/>

D²Pak Tape & Reel Information

Dimensions are shown in millimeters (inches)

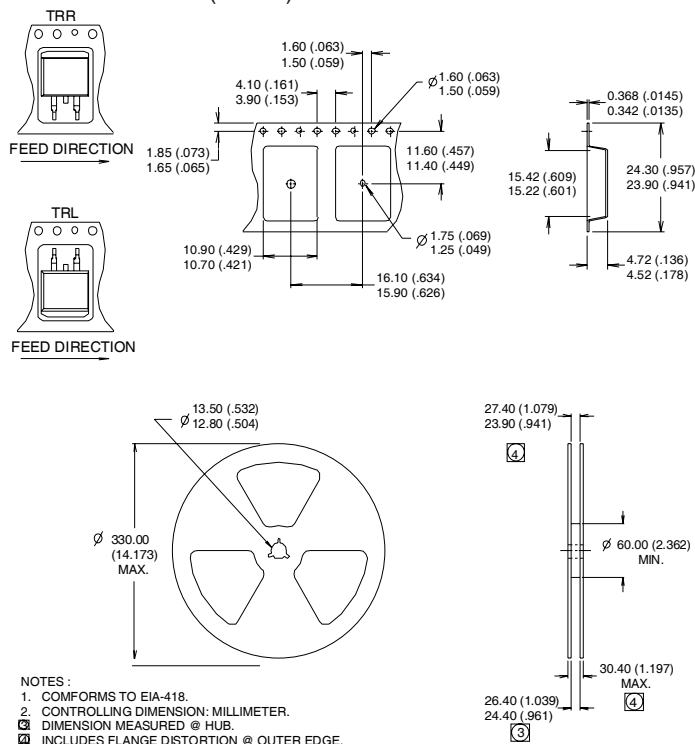

Notes:

- ① Repetitive rating: $V_{GE}=20V$; pulse width limited by maximum junction temperature (figure 20).
- ② $V_{CC}=80\%(V_{CES})$, $V_{GE}=20V$, $L=10\mu H$, $R_G = 23\Omega$ (figure 19).
- ③ Pulse width $\leq 80\mu s$; duty factor $\leq 0.1\%$.
- ④ Pulse width $5.0\mu s$, single shot.
- ⑤ When mounted on 1" square PCB (FR-4 or G-10 Material).

Data and specifications subject to change without notice.

Looking for pricing, stock, or lifecycle information?

Click below to explore more details on WIN SOURCE:

 [View IRG4BC30FD-SPBF on WIN SOURCE](#)

 [Infineon Technologies](#) Information

Optimize Your Supply Chain with WIN SOURCE Solutions

-  Global Sourcing Solution
-  Obsolete Management
-  Cost Control Management
-  Shortage Management
-  Alternative Solution
-  Excess Inventory Management