



**THE DATASHEET OF
TG.30.8113W**





TAOGLAS®



Datasheet

Apex Series

Part No:
TG.30.8113W

Description

Apex Series – Hinged TG.30 Wideband 5G/4G and Wi-Fi Antenna

Features:

- Operates from 600MHz - 7125MHz
- Highest efficiency for worldwide LTE and Wi-Fi Bands
- Covering LTE / CAT-M1 / NB-IoT / GPS / Wi-Fi
- High-performance Dipole Terminal Antenna Design
- Hinged 90° termination with SMA(M) Connector
- Enhanced hinge for high vibration environments
- Dimensions: 186mm * 49mm * 13mm
- RoHS & REACH Compliant

1.	Introduction	3
2.	Specification	4
3.	Mechanical Drawing	7
4.	Installation Guide	8
5.	Packaging	9
6.	Antenna Characteristics	10
7.	Radiation Patterns	15
<hr/>		
	Changelog	72

Taoglas makes no warranties based on the accuracy or completeness of the contents of this document and reserves the right to make changes to specifications and product descriptions at any time without notice. Taoglas reserves all rights to this document and the information contained herein. Reproduction, use or disclosure to third parties without express permission is strictly prohibited.

Ireland & USA
ISO 9001:2015
Certified



Taiwan
ISO 9001:2015
Certified



1. Introduction



The hinged Apex TG.30 is a Wideband Dipole 5G/4G Antenna – is primarily designed for use with 5G/4G and Wi-Fi 6 modules, routers and devices that require the highest possible efficiency and peak gain to deliver best in class throughput on all major cellular bands worldwide between 600MHz and 7.5GHz.

The antenna is a Ground plane independent antenna with a SMA (M) connector and swivel mechanism that allows the antenna part to be rotated. The Apex exhibits high efficiency across the wide spectrum and is backward compatible with 2G and 3G cellular applications such as NB-IoT, Cat-M, LTE, UMTS, Wi-Fi and even has GROUND PLANES included for Assisted GROUND PLANES and/or E911 applications.

Typical Applications include:

- Routers and Gateways
- Access Points
- Remote Monitoring

With very high efficiency on every cellular band globally it is an ideal solution for any device requiring high, reliable performance. It is also guaranteed to meet any type of approval or carrier certification requirements from a RF standpoint. It is an omni-directional antenna, and the radiation patterns display this and are stable across all bands.

It has a quality robust UV resistant housing for use with wireless terminals. The swivel and hinge mechanism allows the antenna part itself to be orientated in different directions and can help avoid touching off other antennas or objects close by as well as helping with isolation by orientating the antenna in different directions in MIMO systems for when other TG.30 antennas are present on the same device.

This patented antenna is available in White and Black versions. The antenna blade can swivel 90 degrees from the connector accommodating different installation environments. It is also available with Straight and Right-Angle connectors. For further information please contact your regional Taoglas customer support team.

2. Specification

LTE Electrical								
Band	Frequency (MHz)	Measurement	Efficiency (%)	Average Gain (dB)	Peak Gain (dBi)	Impedance	Polarization	Radiation Pattern
5G NR/4G Band 71	617-698	Bent Centre Ground Plane	11.0	-9.57	-1.45	50 Ω	Linear	Omni-directional
		Bent Edge Ground Plane	30.7	-5.13	1.38			
		Bent Free Space	30.2	-5.20	0.21			
		Straight Centre Ground Plane	36.5	-4.38	0.87			
		Straight Edge Ground Plane	28.8	-5.41	0.93			
		Straight Free Space	28.0	-5.53	-0.09			
4G/3G Band 12,13,14,17,28,29	698-806	Bent Centre Ground Plane	37.5	-4.26	3.82			
		Bent Edge Ground Plane	74.6	-1.27	4.24			
		Bent Free Space	73.5	-1.34	2.30			
		Straight Centre Ground Plane	83.0	-0.81	3.75			
		Straight Edge Ground Plane	73.1	-1.36	2.77			
		Straight Free Space	73.3	-1.35	2.34			
4G/3G/NB-IoT/Cat M Band 5,8,18,19,20,26,27	824-960	Bent Centre Ground Plane	32.0	-4.95	3.02			
		Bent Edge Ground Plane	73.8	-1.32	2.68			
		Bent Free Space	67.4	-1.72	3.17			
		Straight Centre Ground Plane	72.4	-1.40	1.93			
		Straight Edge Ground Plane	79.9	-0.98	4.38			
		Straight Free Space	69.8	-1.56	3.61			
5G NR/4G Band 21,32,74,75,76	1427-1518	Bent Centre Ground Plane	59.0	-2.29	6.72			
		Bent Edge Ground Plane	51.6	-2.88	1.96			
		Bent Free Space	48.7	-3.13	2.76			
		Straight Centre Ground Plane	47.4	-3.24	4.86			
		Straight Edge Ground Plane	46.7	-3.31	2.76			
		Straight Free Space	44.1	-3.56	3.69			
4G/3G Band 1,2,3,4,9,23,25,35,39,66	1710-2200	Bent Centre Ground Plane	65.7	-1.83	7.54			
		Bent Edge Ground Plane	62.1	-2.07	2.52			
		Bent Free Space	75.3	-1.23	3.20			
		Straight Centre Ground Plane	70.1	-1.54	3.49			
		Straight Edge Ground Plane	57.7	-2.39	3.48			
		Straight Free Space	70.7	-1.50	4.31			
4G/3G Band 7,30,38,40,41	2300-2690	Bent Centre Ground Plane	62.9	-2.01	6.40			
		Bent Edge Ground Plane	51.6	-2.87	4.19			
		Bent Free Space	64.9	-1.88	3.94			
		Straight Centre Ground Plane	43.8	-3.59	5.53			
		Straight Edge Ground Plane	46.1	-3.36	4.80			
		Straight Free Space	55.9	-2.53	5.16			
5G NR/4G Band 22,42,48,77,78,79	3300-3850	Bent Centre Ground Plane	48.6	-3.14	8.38			
		Bent Edge Ground Plane	33.7	-4.73	6.92			
		Bent Free Space	39.6	-4.02	2.95			
		Straight Centre Ground Plane	34.7	-4.60	3.12			
		Straight Edge Ground Plane	35.0	-4.56	4.03			
		Straight Free Space	39.9	-3.99	3.57			
LTE5200/Wi-Fi5800	5150-5925	Bent Centre Ground Plane	54.4	-2.64	8.06			
		Bent Edge Ground Plane	37.8	-4.23	4.72			
		Bent Free Space	52.8	-2.77	4.48			
		Straight Centre Ground Plane	56.7	-2.46	9.37			
		Straight Edge Ground Plane	35.7	-4.48	4.04			
		Straight Free Space	51.5	-2.88	3.72			
WiFi - 6GHz	5925-7125	Bent Centre Ground Plane	66.9	-1.75	9.09			
		Bent Edge Ground Plane	28.9	-5.39	6.42			
		Bent Free Space	64.5	-1.90	5.11			
		Straight Centre Ground Plane	66.0	-1.80	10.37			
		Straight Edge Ground Plane	31.6	-5.00	4.14			
		Straight Free Space	63.3	-1.98	5.14			

5G/4G Bands

Band Number	5G NR / FR1 / LTE / LTE-Advanced / WCDMA / HSPA / HSPA+ / TD-SCDMA							
	Uplink	Downlink	Bent Centre Ground Plane	Bent Edge Ground Plane	Bent Free Space	Straight Centre Ground Plane	Straight Edge Ground Plane	Straight Free Space
B1	1920 to 1980	2110 to 2170	✓	✓	✓	✓	✓	✓
B2	1850 to 1910	1930 to 1990	✓	✓	✓	✓	✓	✓
B3	1710 to 1785	1805 to 1880	✓	✓	✓	✓	✓	✓
B4	1710 to 1755	2110 to 2155	✓	✓	✓	✓	✓	✓
B5	824 to 849	869 to 894	✓	✓	✓	✓	✓	✓
B7	2500 to 2570	2620 to 2690	✓	✓	✓	✓	✓	✓
B8	880 to 915	925 to 960	✓	✓	✓	✓	✓	✓
B9*	1749.9 to 1784.9	1844.9 to 1879.9	✓	✓	✓	✓	✓	✓
B11	1427.9 to 1447.9	1475.9 to 1495.9	✓	✓	✓	✓	✓	✓
B12	699 to 716	729 to 746	✓	✓	✓	✓	✓	✓
B13	777 to 787	746 to 756	✓	✓	✓	✓	✓	✓
B14	788 to 798	758 to 768	✓	✓	✓	✓	✓	✓
B17	704 to 716	734 to 746	✓	✓	✓	✓	✓	✓
B18	815 to 830	860 to 875	✓	✓	✓	✓	✓	✓
B19	830 to 845	875 to 890	✓	✓	✓	✓	✓	✓
B20	832 to 862	791 to 821	✓	✓	✓	✓	✓	✓
B21	1447.9 to 1462.9	1495.9 to 1510.9	✓	✓	✓	✓	✓	✓
B22*	3410 to 3490	3510 to 3590	✓	✓	✓	✓	✓	✓
B23*	2000 to 2020	2180 to 2200	✓	✓	✓	✓	✓	✓
B24	1626.5 to 1660.5	1525 to 1559	✓	✓	✓	✓	✓	✓
B25	1850 to 1915	1930 to 1995	✓	✓	✓	✓	✓	✓
B26	814 to 849	859 to 894	✓	✓	✓	✓	✓	✓
B27*	807 to 824	852 to 869	✓	✓	✓	✓	✓	✓
B28	703 to 748	758 to 803	✓	✓	✓	✓	✓	✓
B29	717 to 728		✓	✓	✓	✓	✓	✓
B30	2305 to 2315	2350 to 2360	✓	✓	✓	✓	✓	✓
B31	452.5 to 457.5	462.5 to 467.5	✗	✗	✗	✗	✗	✗
B32	1452 to 1496		✓	✓	✓	✓	✓	✓
B34	2010 to 2025		✓	✓	✓	✓	✓	✓
B35	1850 to 1910		✓	✓	✓	✓	✓	✓
B36	1930 to 1990		✓	✓	✓	✓	✓	✓
B37	1910 to 1930		✓	✓	✓	✓	✓	✓
B38	2570 to 2620		✓	✓	✓	✓	✓	✓
B39	1880 to 1920		✓	✓	✓	✓	✓	✓
B40	2300 to 2400		✓	✓	✓	✓	✓	✓
B41	2496 to 2690		✓	✓	✓	✓	✓	✓
B42	3400 to 3600		✓	✓	✓	✓	✓	✓
B43	3600 to 3800		✓	✓	✓	✓	✓	✓
B45	1447 to 1467		✓	✓	✓	✓	✓	✓
B46	5150 to 5925		✓	✓	✓	✓	✓	✓
B47	5855 to 5925		✓	✓	✓	✓	✓	✓
B48	3550 to 3700		✓	✓	✓	✓	✓	✓
B49	3550 to 3700		✓	✓	✓	✓	✓	✓
B50	1432 to 1517		✓	✓	✓	✓	✓	✓
B51	1427 to 1432		✓	✓	✓	✓	✓	✓
B52	3300 to 3400		✓	✓	✓	✓	✓	✓
B53	2483.5 to 2495		✓	✓	✓	✓	✓	✓
B65	1920 to 2010	2110 to 2200	✓	✓	✓	✓	✓	✓
B66	1710 to 1780	2110 to 2200	✓	✓	✓	✓	✓	✓
B68	698 to 728	753 to 783	✓	✓	✓	✓	✓	✓
B69	2570 to 2620		✓	✓	✓	✓	✓	✓
B70	1695 to 1710	1995 to 2020	✓	✓	✓	✓	✓	✓
B71	663 to 698	617 to 652	✗	✗	✗	✗	✗	✗
B72	451 to 456	461 to 466	✗	✗	✗	✗	✗	✗
B73	450 to 455	460 to 465	✗	✗	✗	✗	✗	✗
B74	1427 to 1470	1475 to 1518	✓	✓	✓	✓	✓	✓
B75	1432 to 1517		✓	✓	✓	✓	✓	✓
B76	1427 to 1432		✓	✓	✓	✓	✓	✓
B77	3300 to 4200		✓	✓	✓	✓	✓	✓
B78	3300 to 3800		✓	✓	✓	✓	✓	✓
B79	4400 to 5000		✓	✓	✓	✓	✓	✓
B85	698 to 716	728 to 746	✗	✗	✗	✗	✗	✗
B87	410 to 415	420 to 425	✗	✗	✗	✗	✗	✗
B88	412 to 417	422 to 427	✗	✗	✗	✗	✗	✗

Mechanical

Casing	UV Resistant PC/ABS
Flammability Rating	UL-94
Connector	SMA Male Hinged 90°

Environmental

Temperature Range	-40°C to 85°C
Humidity	Non-condensing 65°C 95% RH

3. Mechanical Drawing

3D View

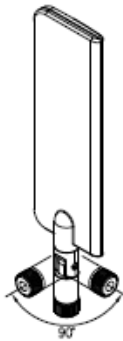

Front View

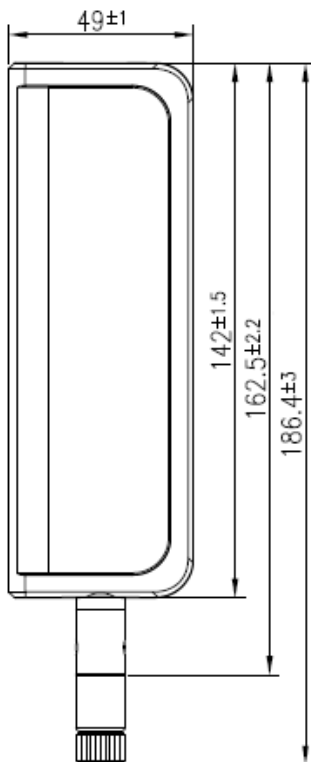

Side View

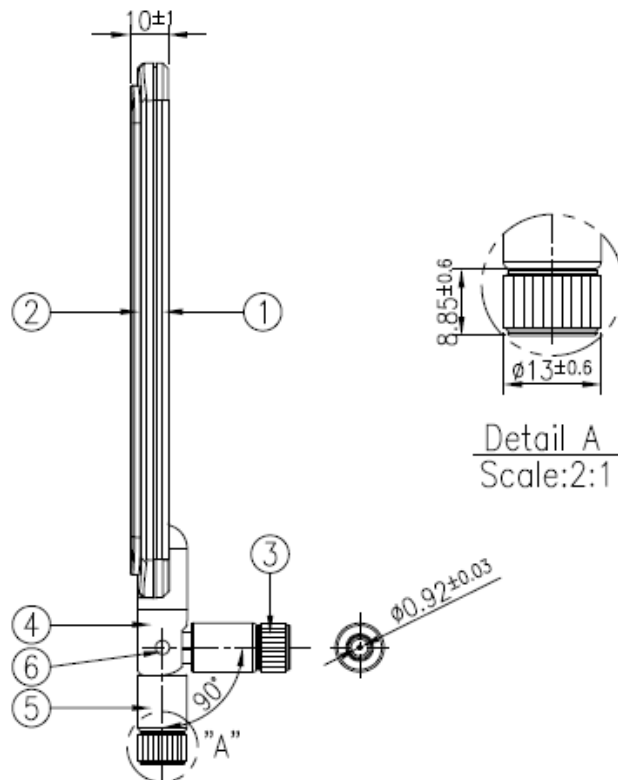

NOTES:

- 1.All material must be RoHS compliant.
- 2.Open/short, insertion loss QC required.
- 3.The connectors have a fixed orientation to each other.

	Name	P/N	Material	Finish	QTY
1	Housing_Bottom_Hinge_W	000112G020020A	ABS	White	1
2	Housing_Top_W	000112G000020A	ABS	White	1
3	SMA(M)ST	210212L020020A	Brass	White	1
4	Hinge_Top_W	000112G040020A	Nylon	White	1
5	Hinge_Bottom_W	000112G030020A	PC+PBT	White	1
6	Rotary Shaft	000612G000002A	Brass	Ni Plated	2

4. Installation Guide

Taoglas produces a range of antennas have independent rotating SMA connectors. This enables the user to install the antenna in a preferable direction. After tightening the SMA connector, the antenna will sit firmly on users' base/router on either a table or on a wall. This installation sheet is illustrated using the TG.45 on a wall mounted device as an example.

Step 1.

Adjust the antenna to preferable direction or orientation, then mount the antennas SMA(M) connector onto the SMA(F) connector of the device. (See figure 1)

Step 2.

Firmly hold the antenna housing with one hand, while rotating the SMA(M) connector with the other hand until the connector is tight and holds a fixed position. (See figure 2) Recommended torque is 0.34 - 0.57 NM or 3 - 5in-lbs.

Note: If more than one antenna is being used and for ease of installation, it is best practice to install the largest antenna first.

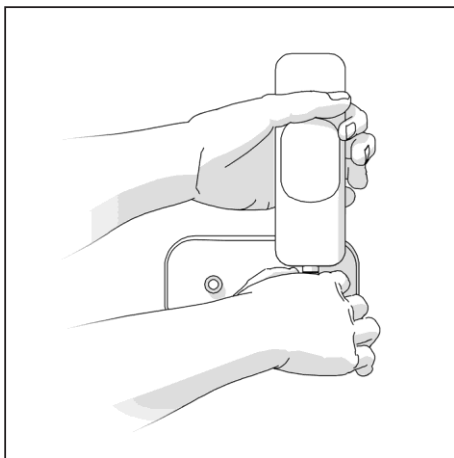

Figure 1.

Place the antenna onto the connector of the device and hold the antenna in the preferred orientation.

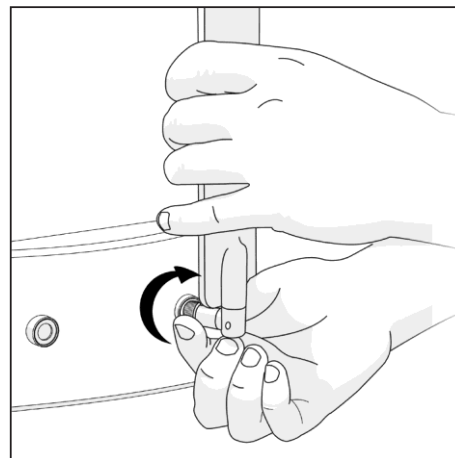
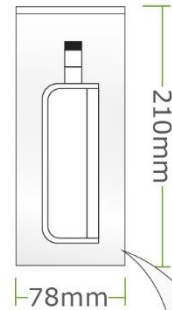

Figure 2.

Fix the connector to the device by twisting the rotating head of the SMA connector until it is tight enough to hold the antenna in the correct position.

5. Packaging

1pc TG.30.8113W per Small PE Bag
 Small PE Bag Dimensions - 210*78mm
 Weight - 127g



50pcs TG.30.8113W per Large PE Bag
 Large PE Bag Dimensions - 450*275mm
 Weight - 6.35Kg

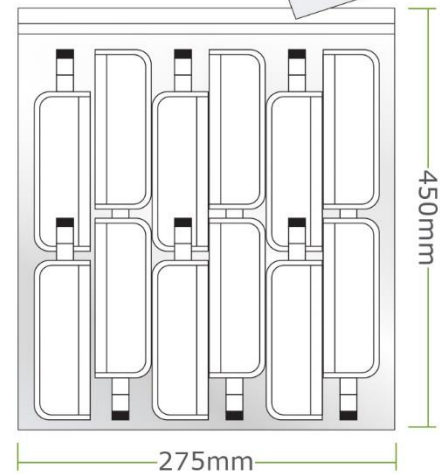

6. Antenna Characteristics

6.1 Test Setup

AUT



Vector Network Analyzer

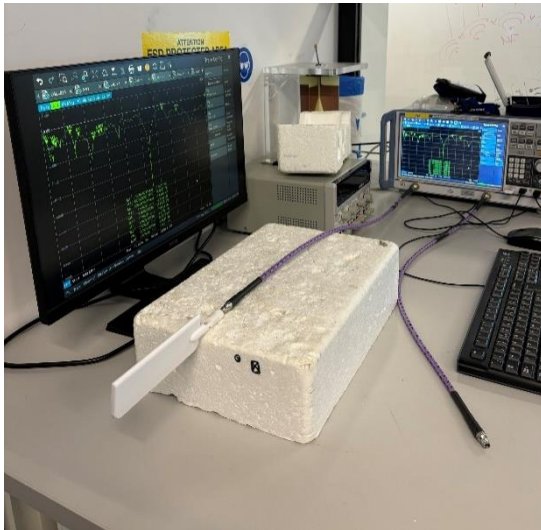

VNA Set up Straight in Free Space



VNA Set up Bent in Free Space

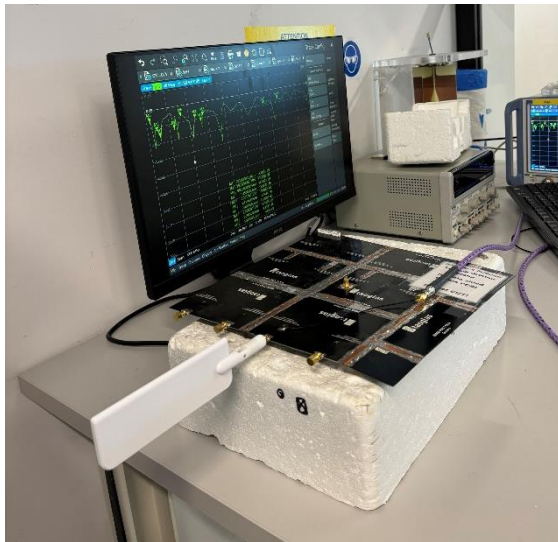

VNA Set up Straight on Edge of 30x30cm Ground Plane

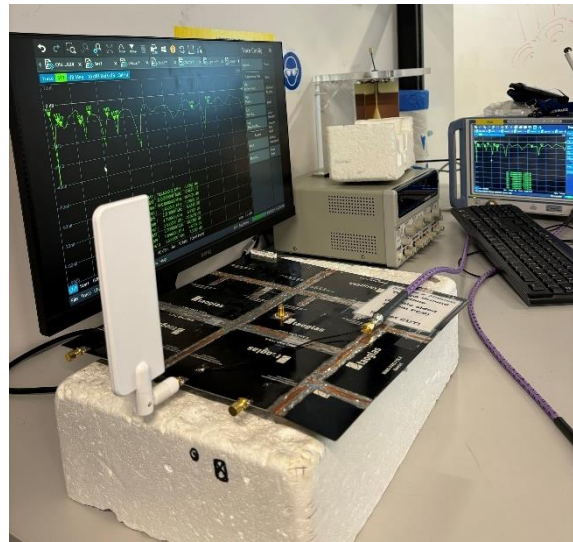

VNA Set up Bent on Edge of 30x30cm Ground Plane

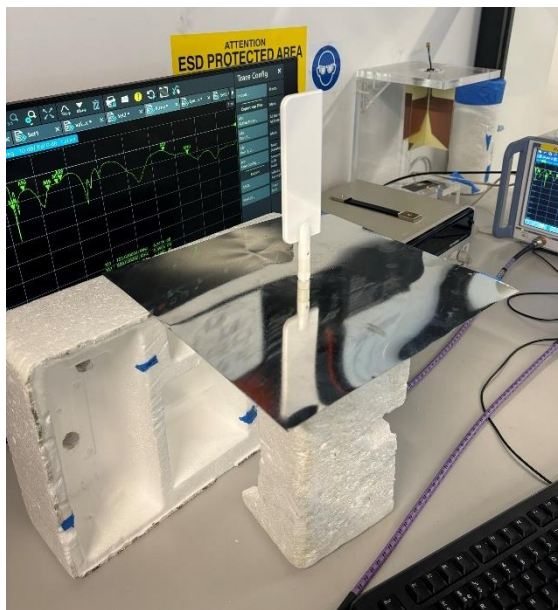

VNA Set up Straight in Centre of 30x30cm Ground Plane

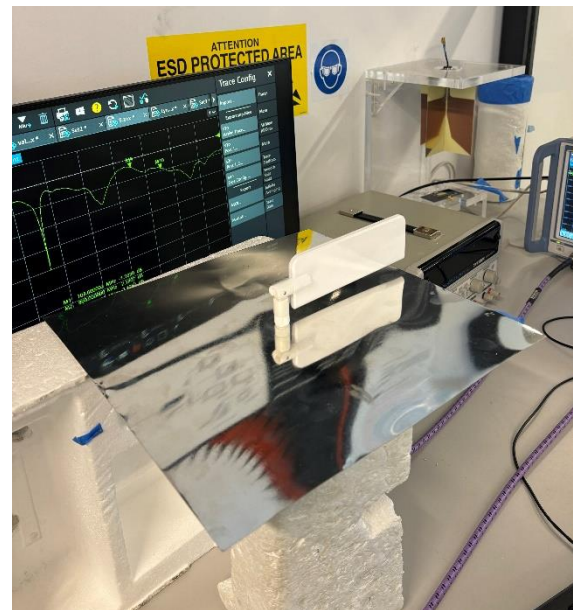

VNA Set up Bent in Centre of 30x30cm Ground Plane

6.2 Return Loss

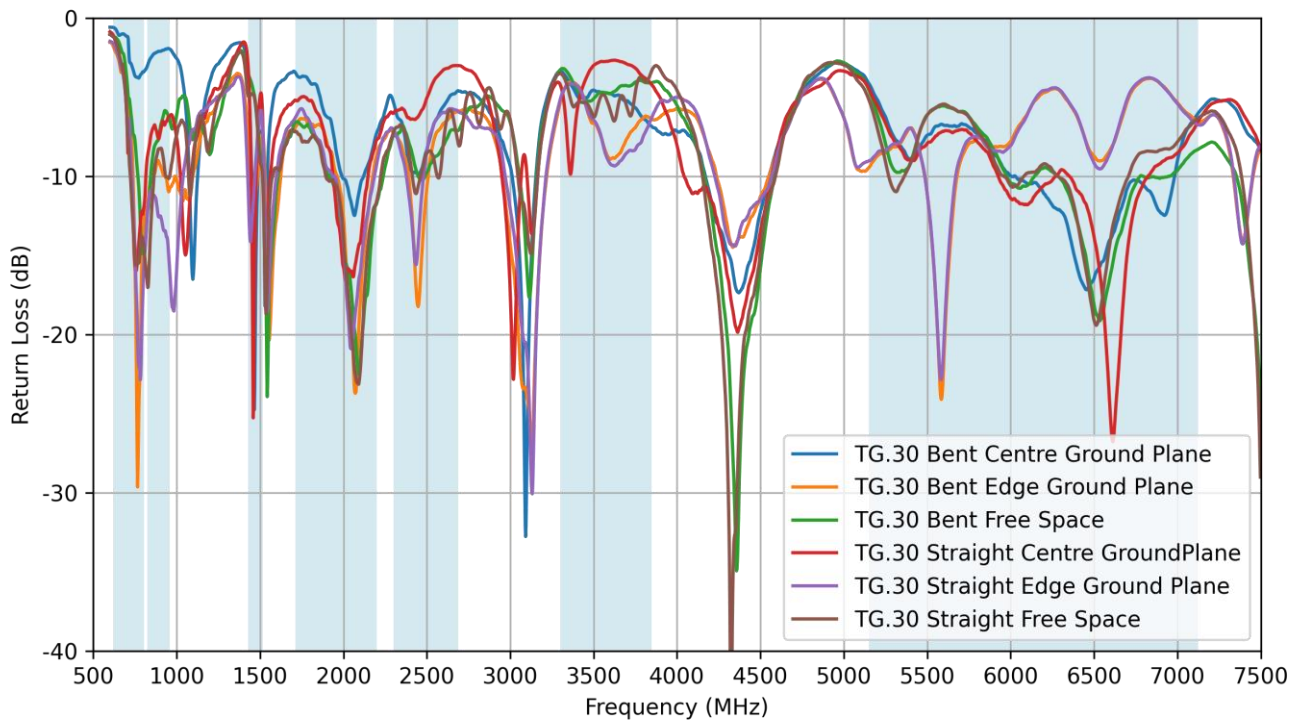

6.3 VSWR

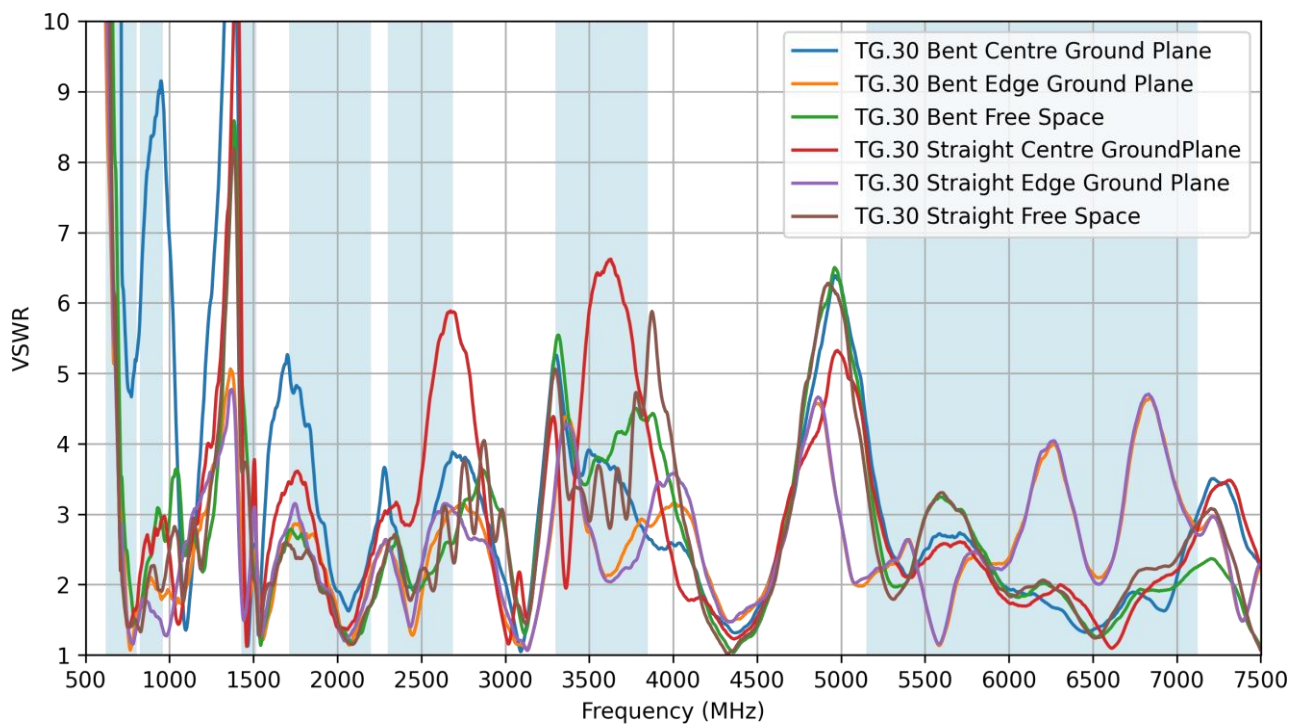

6.4 Efficiency

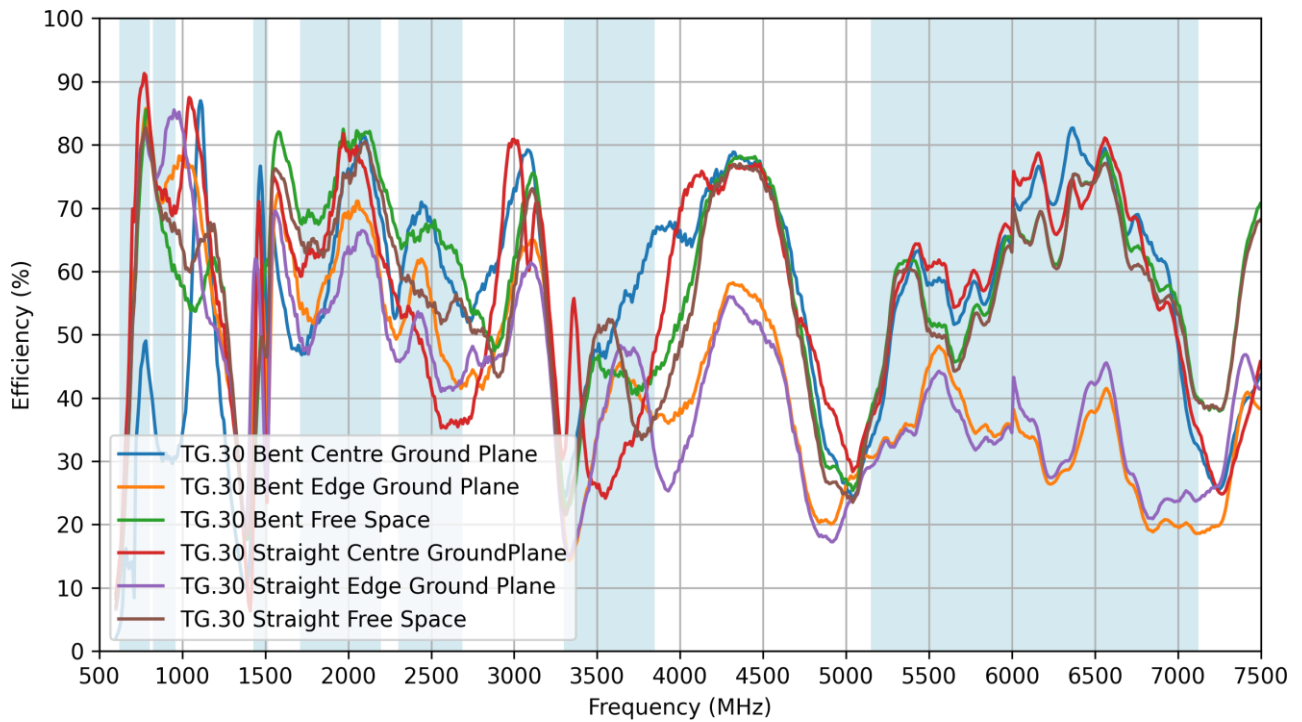

6.5 Average Gain

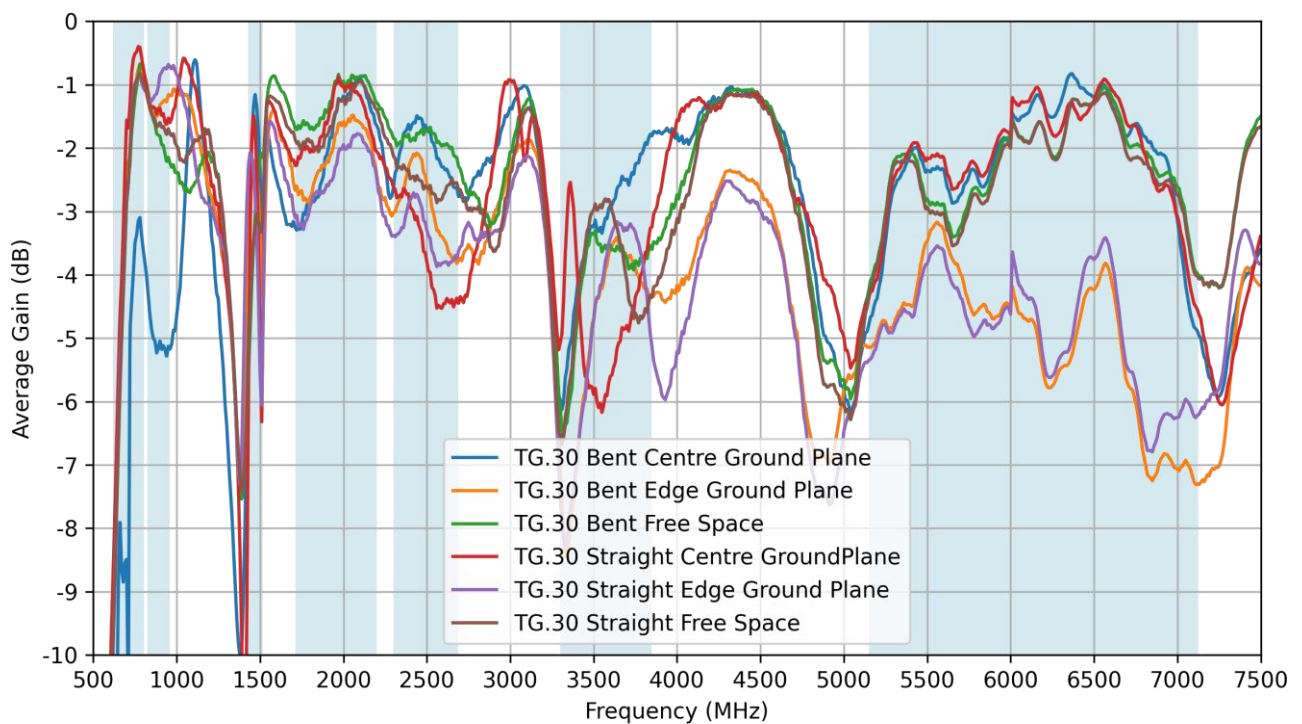

6.6 Peak Gain

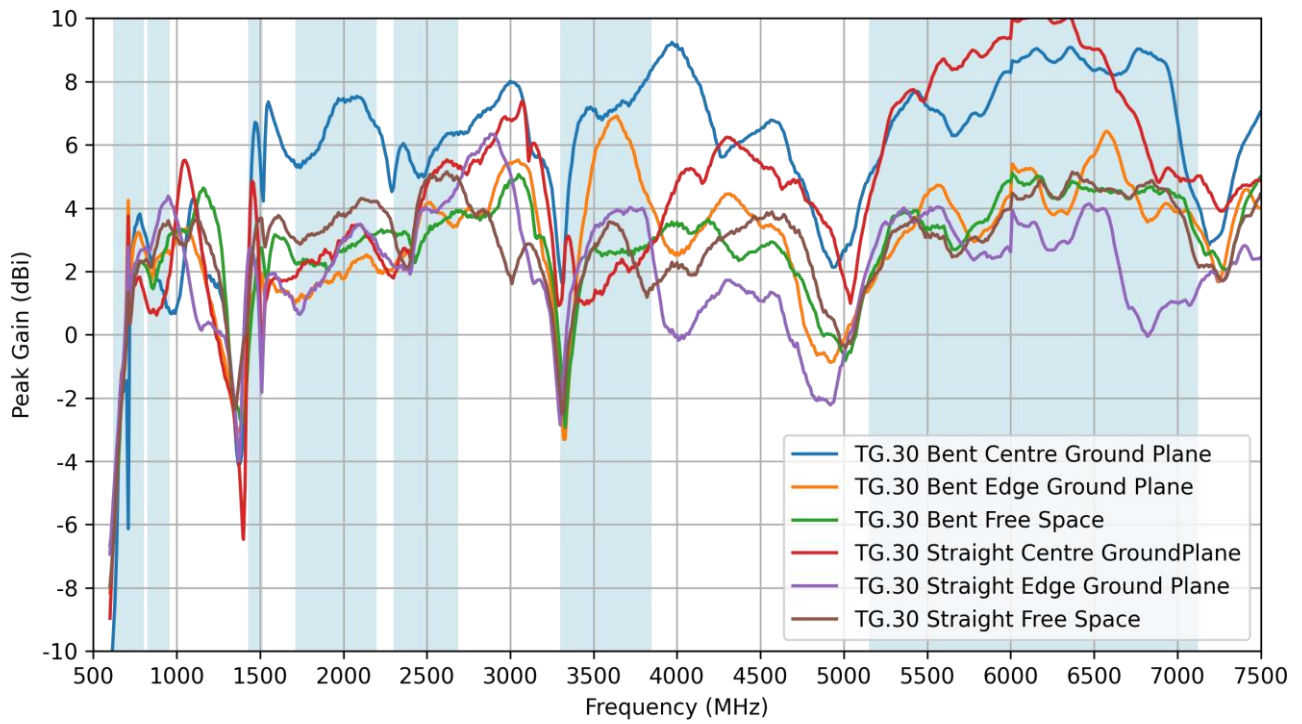

7. Radiation Patterns

7.1 Test Setup

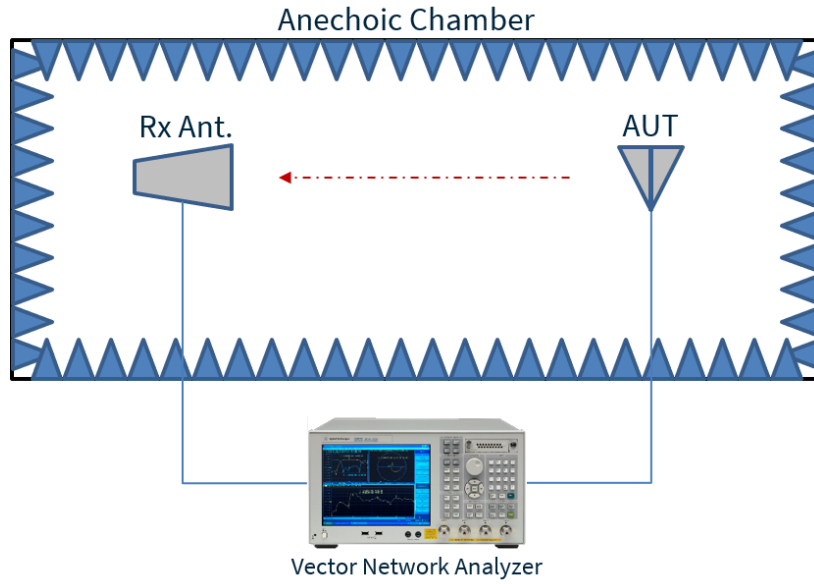

Chamber Set up Straight in Free Space

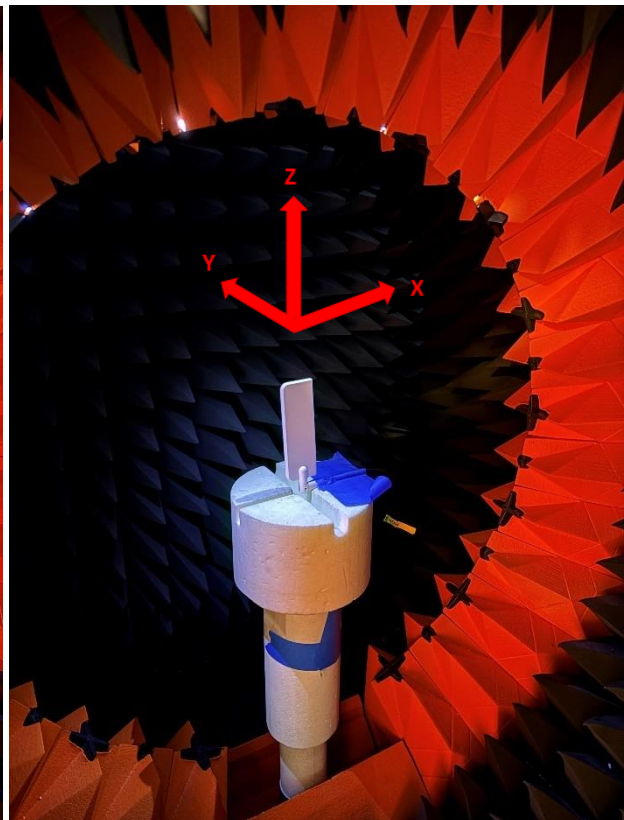

Chamber Set up Bent in Free Space

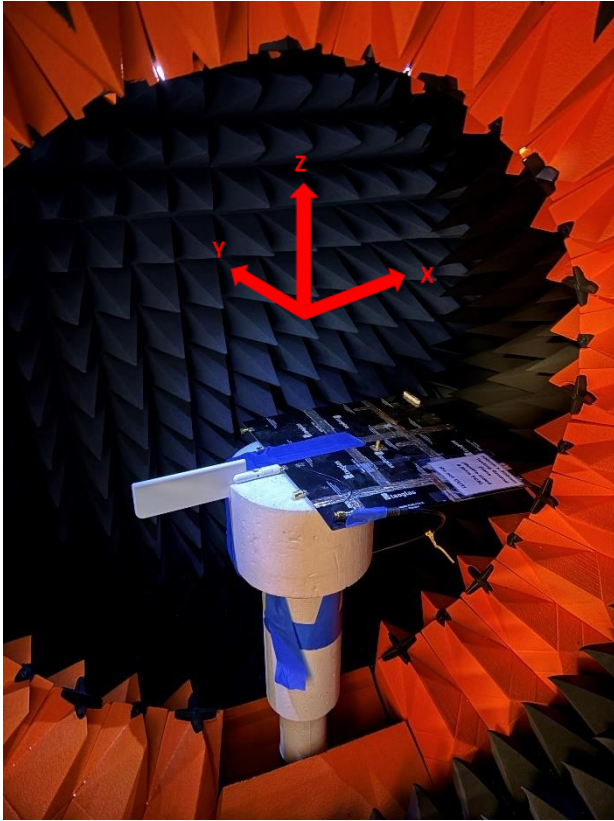

Chamber Set up Straight on the Edge of a 30x30cm Ground Plane

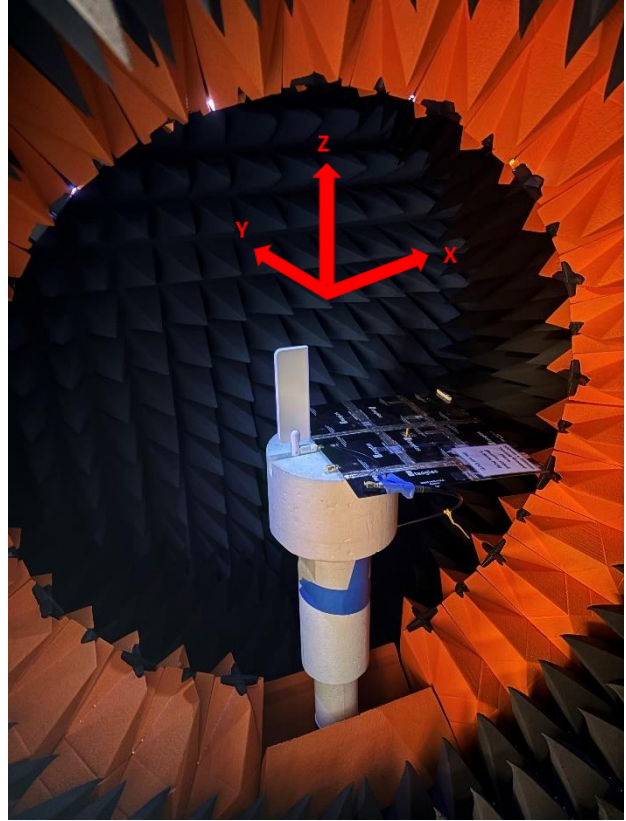

Chamber Set up Bent on the Edge of a 30x30cm Ground Plane

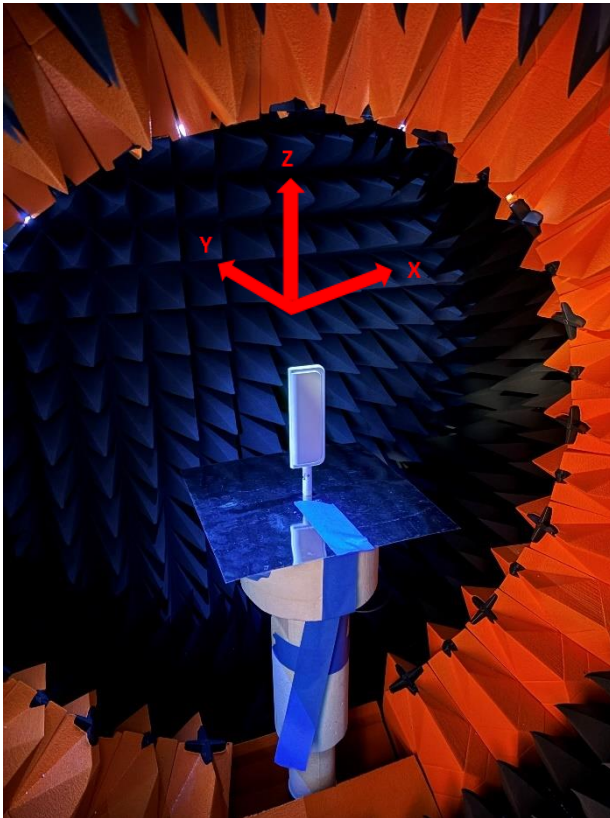

Chamber Set up Straight in the Centre of a 30x30cm Ground Plane

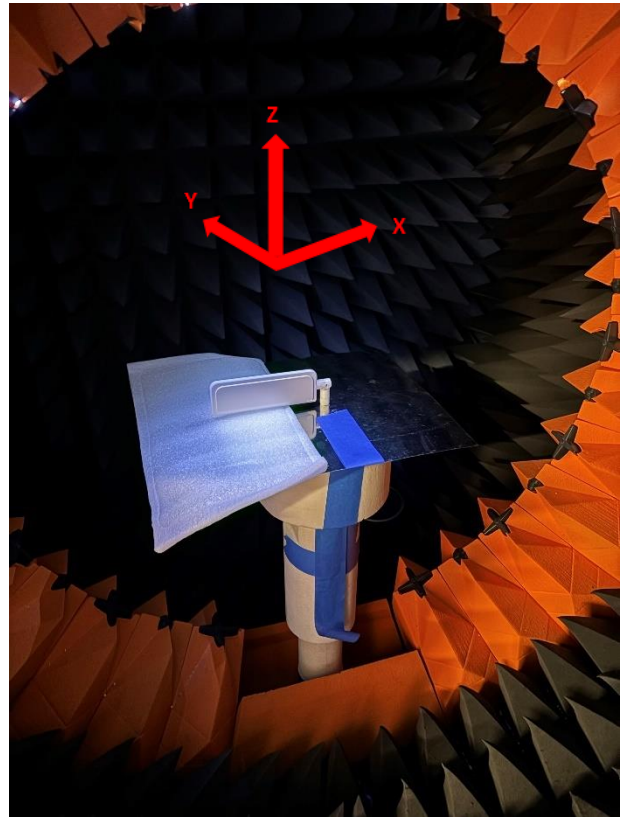

Chamber Set up Bent in the Centre of a 30x30cm Ground Plane

7.2 Bent Centre Ground Plane Patterns at 650 MHz

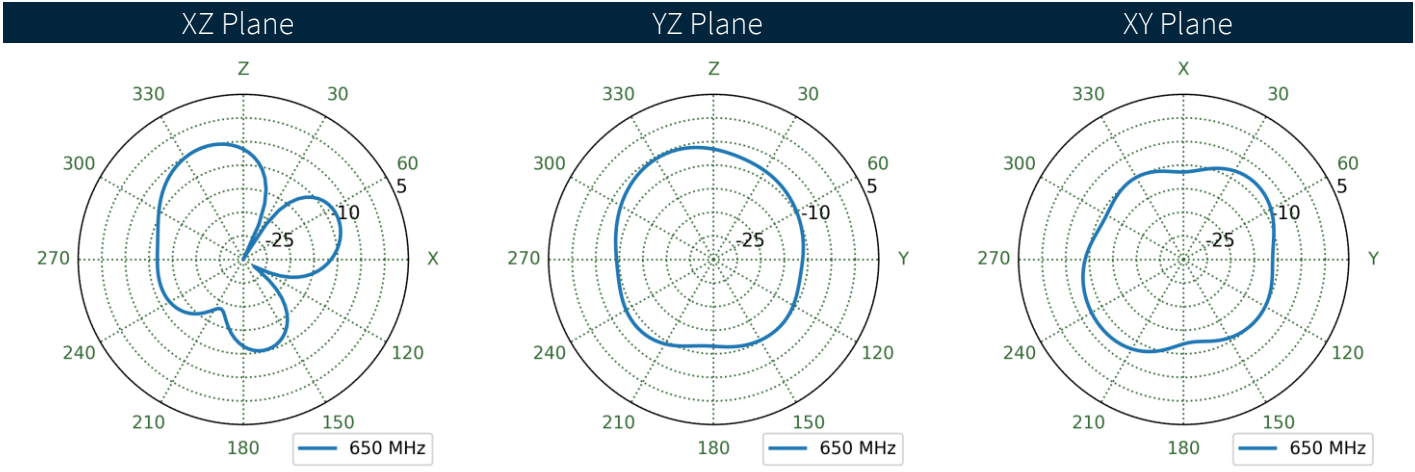
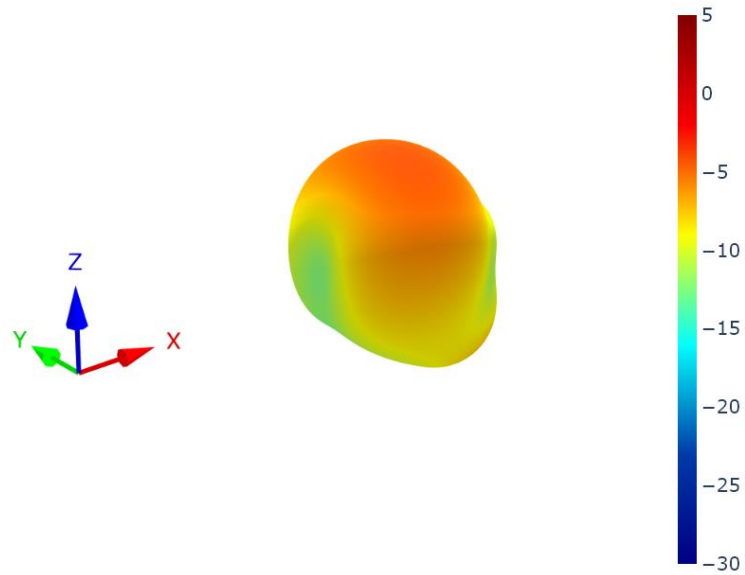

7.3 Bent Edge Ground Plane Patterns at 650 MHz

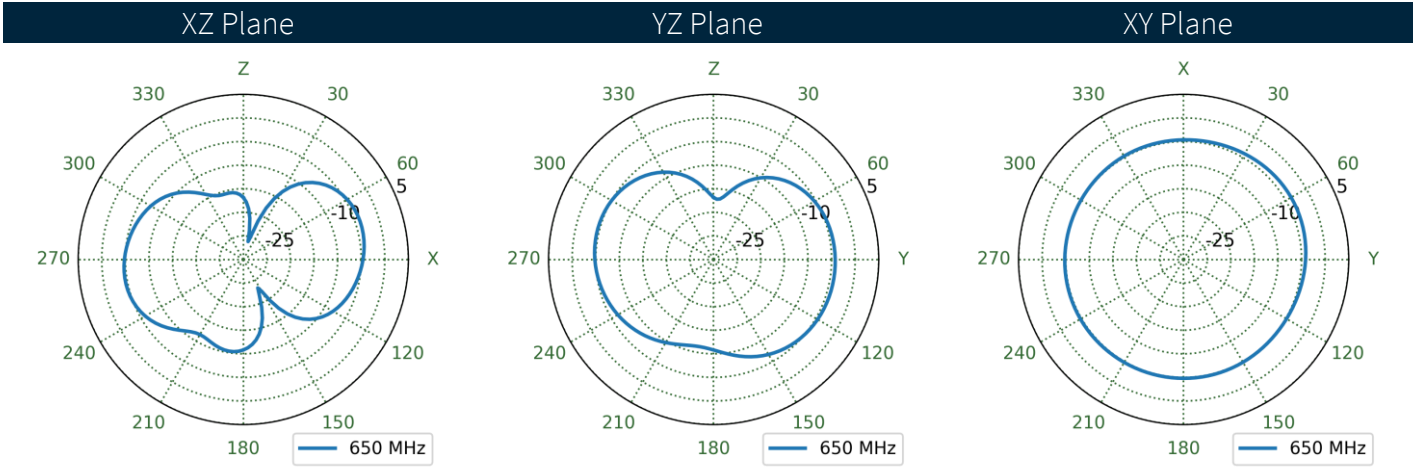
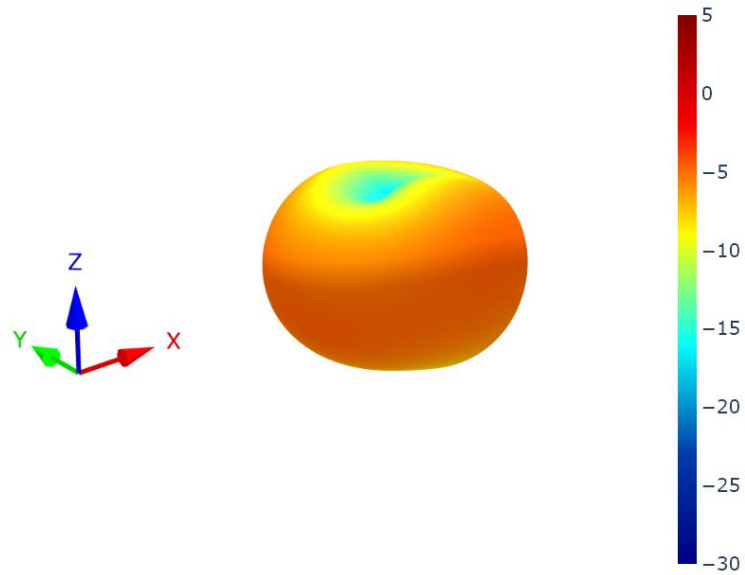

7.4 Bent Free Space Patterns at 650 MHz

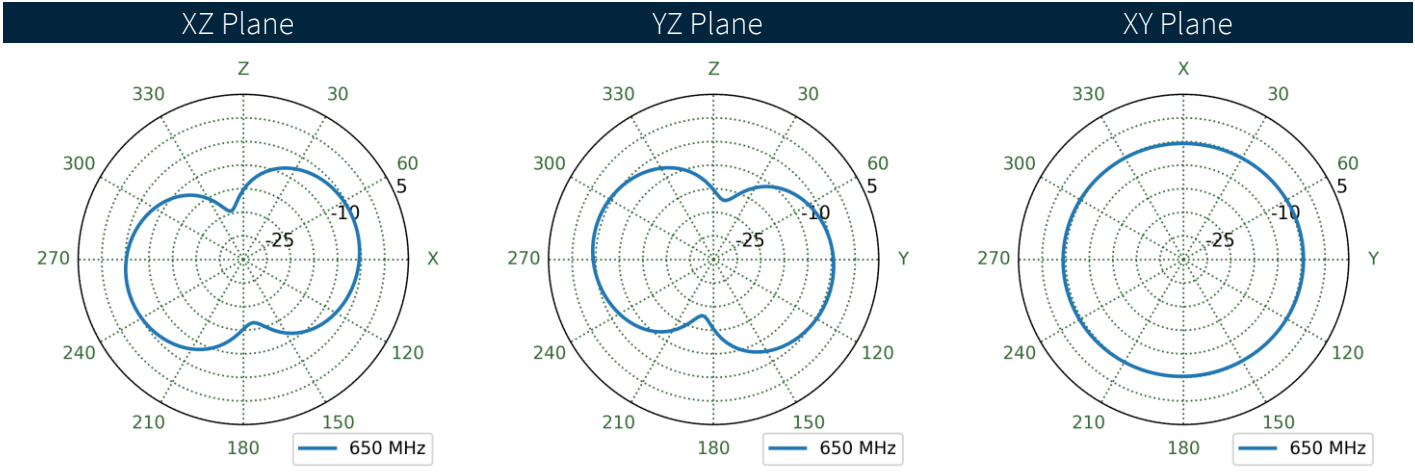
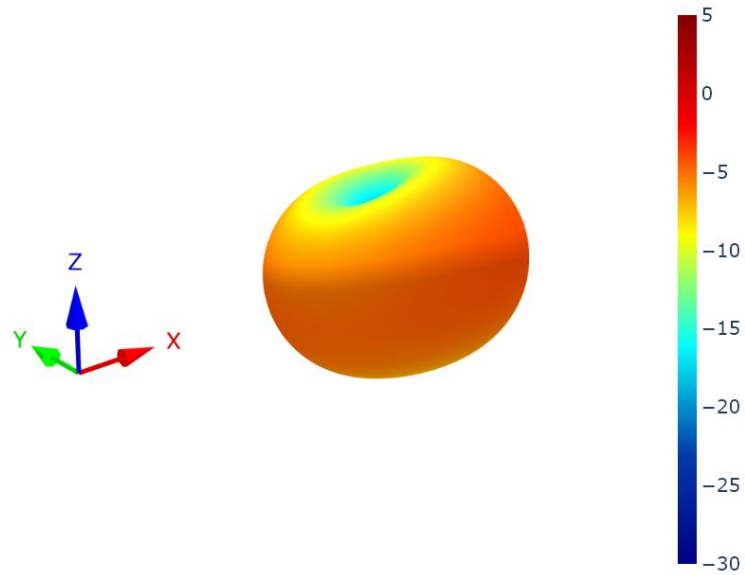

7.5 Straight Centre GroundPlane Patterns at 650 MHz

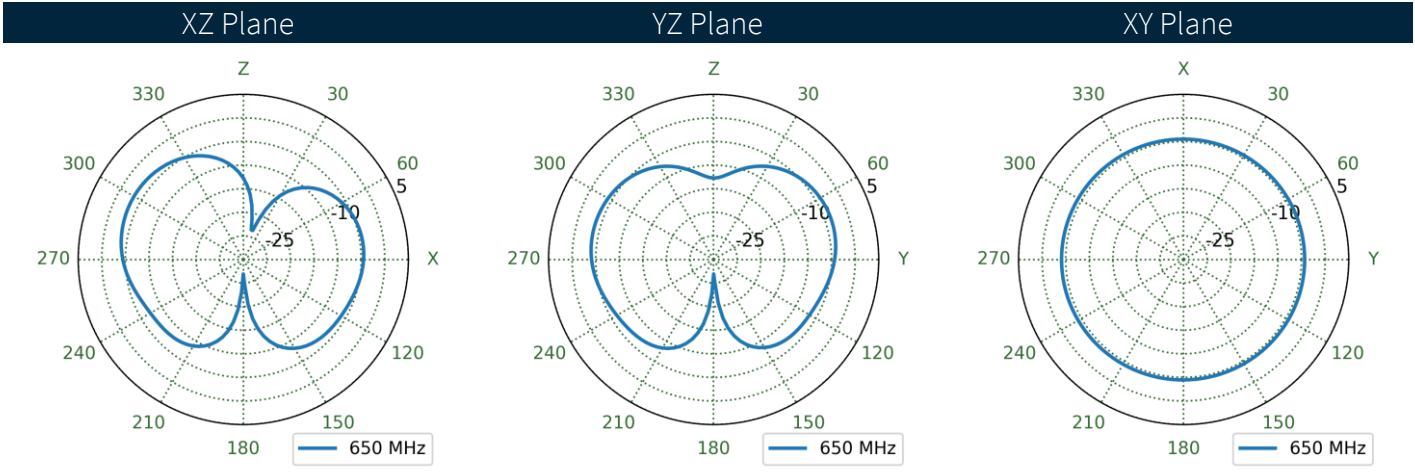
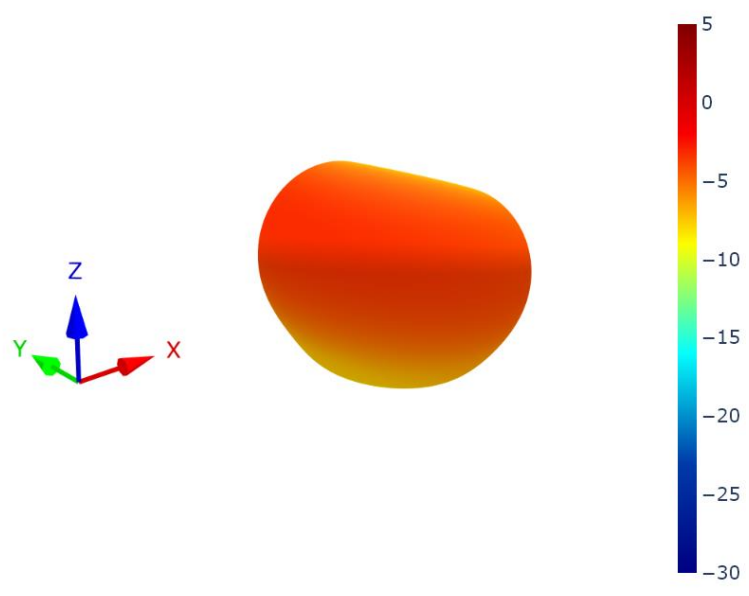

7.6 Straight Edge Ground Plane Patterns at 650 MHz

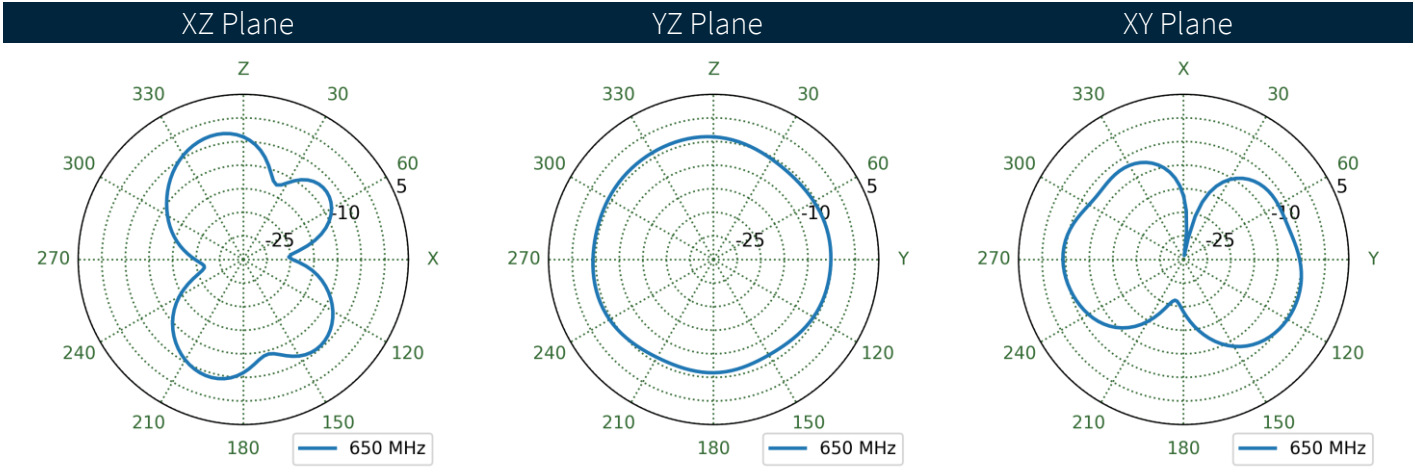
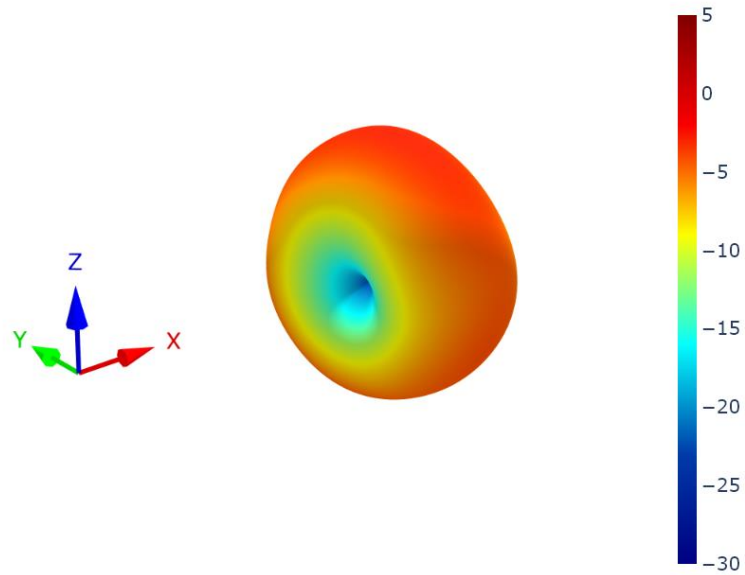

7.7 Straight Free Space Patterns at 650 MHz

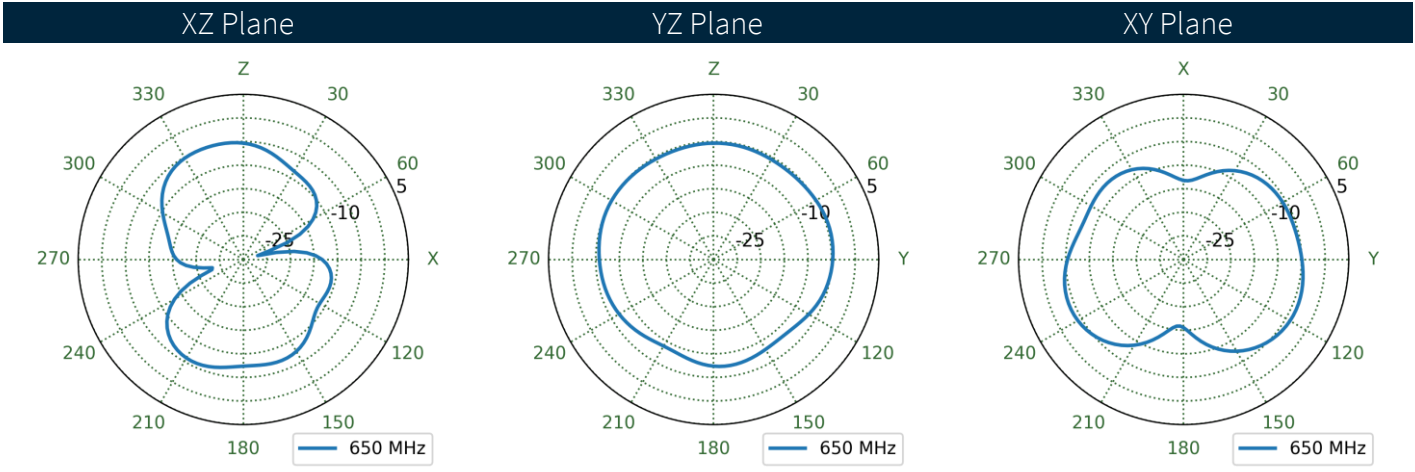
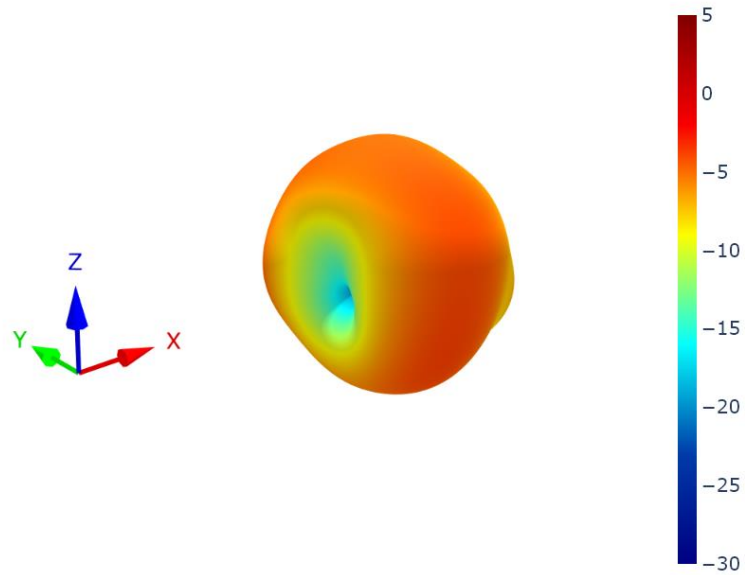

7.8 Bent Centre Ground Plane Patterns at 750 MHz

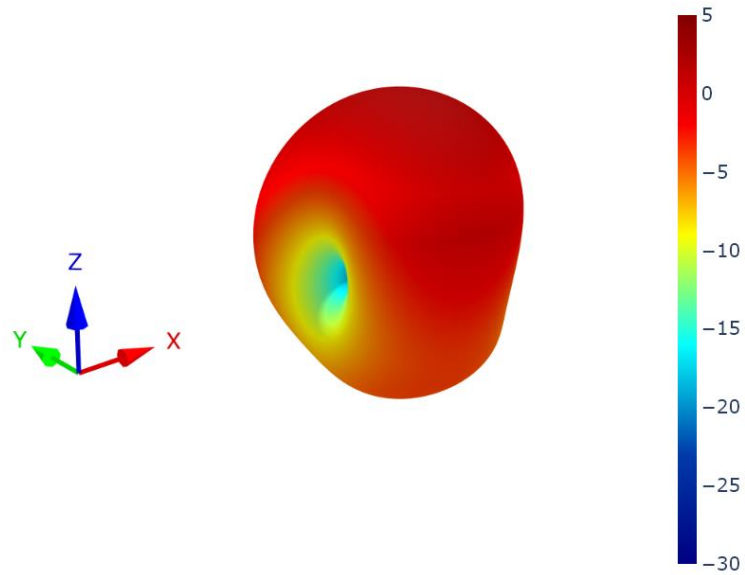

XZ Plane YZ Plane XY Plane

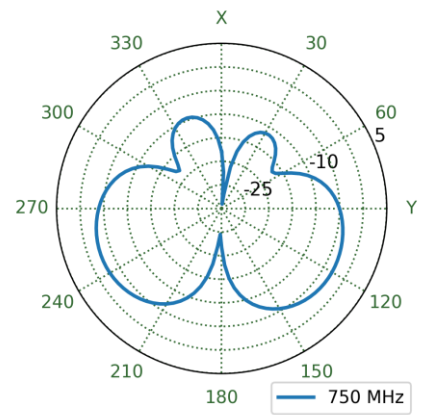
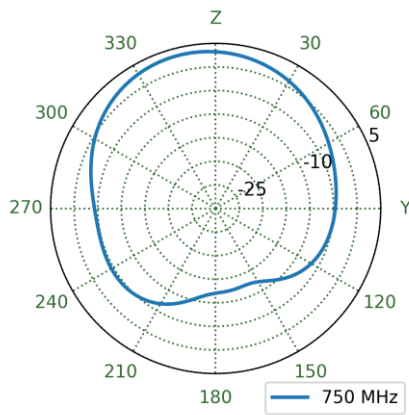
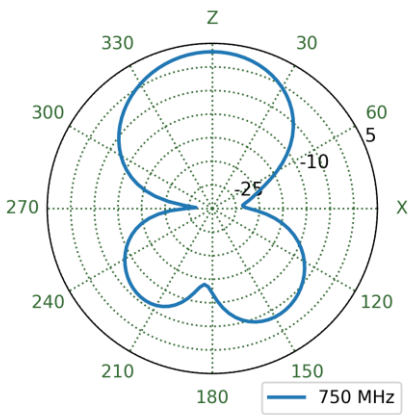

7.9 Bent Edge Ground Plane Patterns at 750 MHz

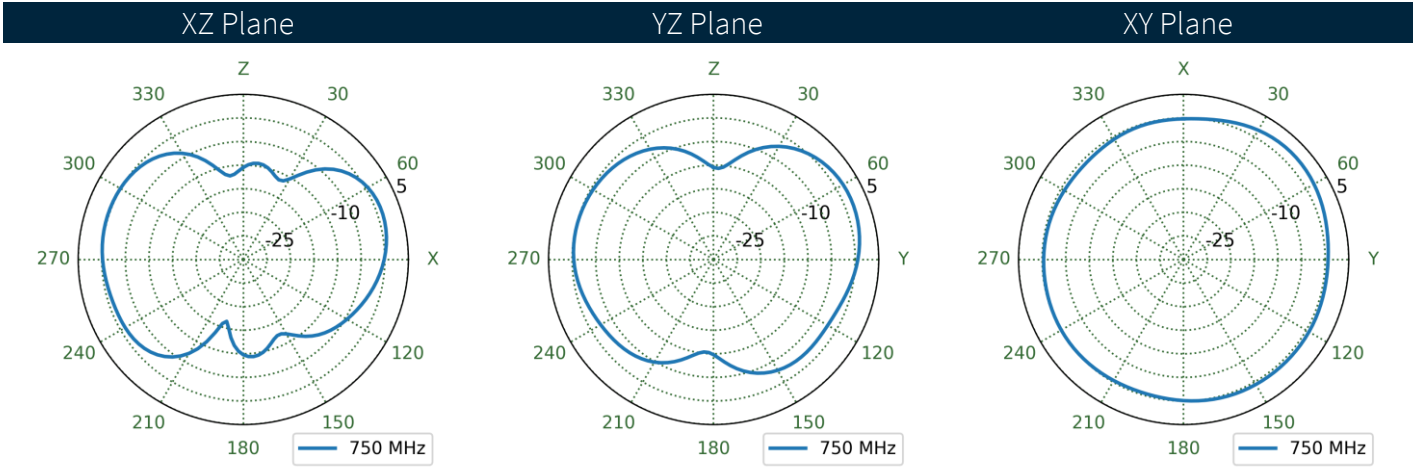
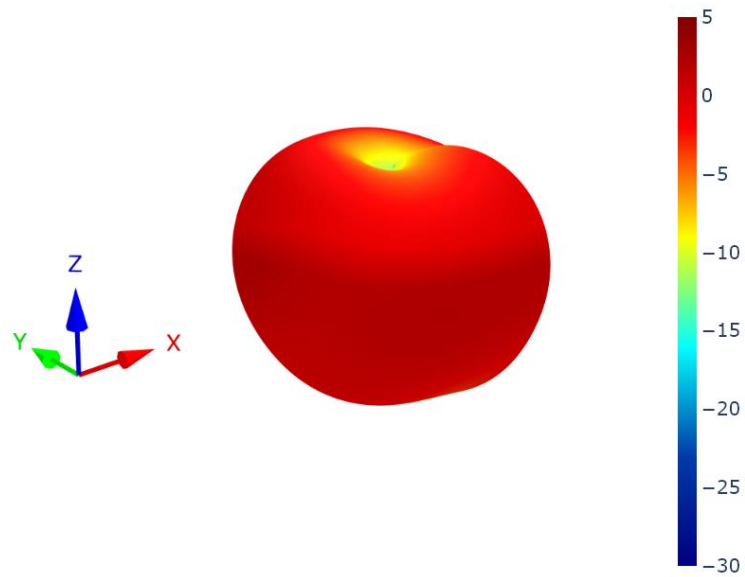

7.10 Bent Free Space Patterns at 750 MHz

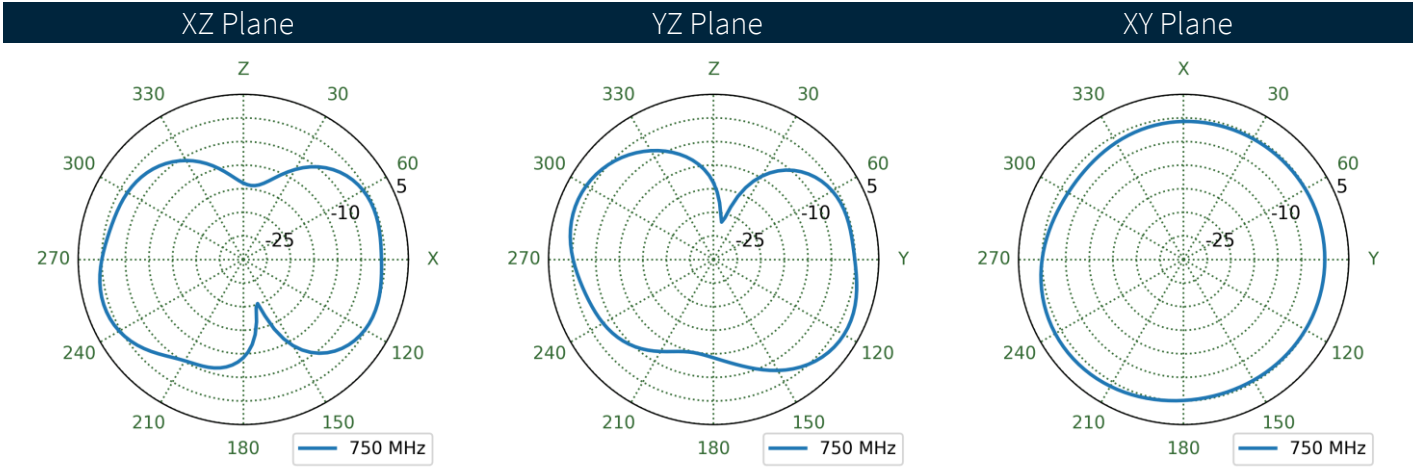
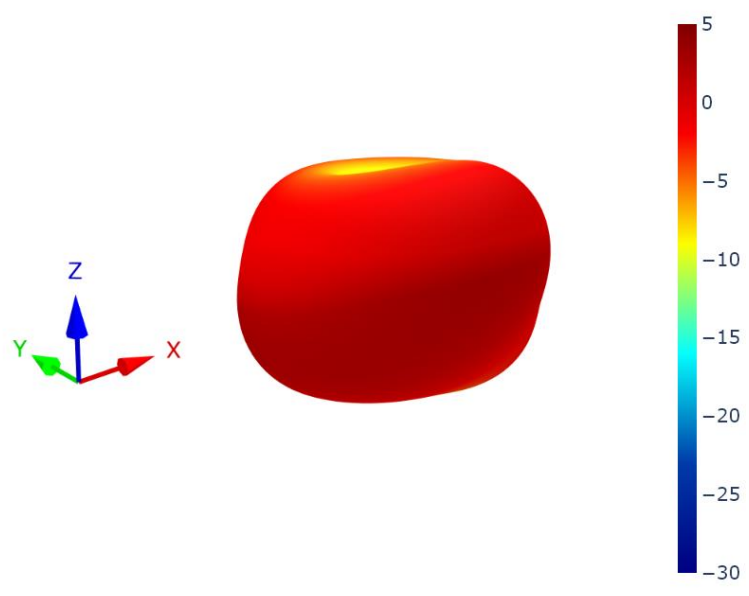

7.11 Straight Centre GroundPlane Patterns at 750 MHz

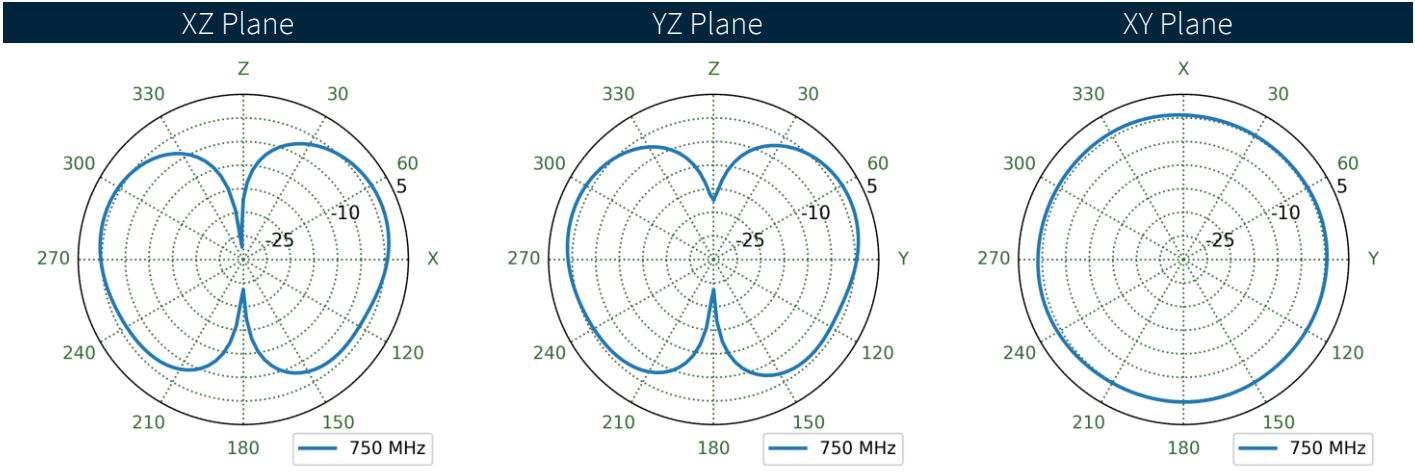
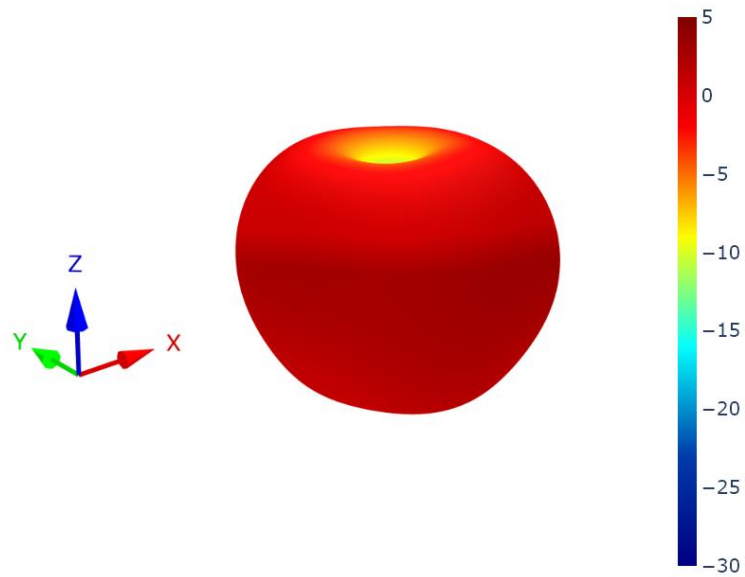

7.12 Straight Edge Ground Plane Patterns at 750 MHz

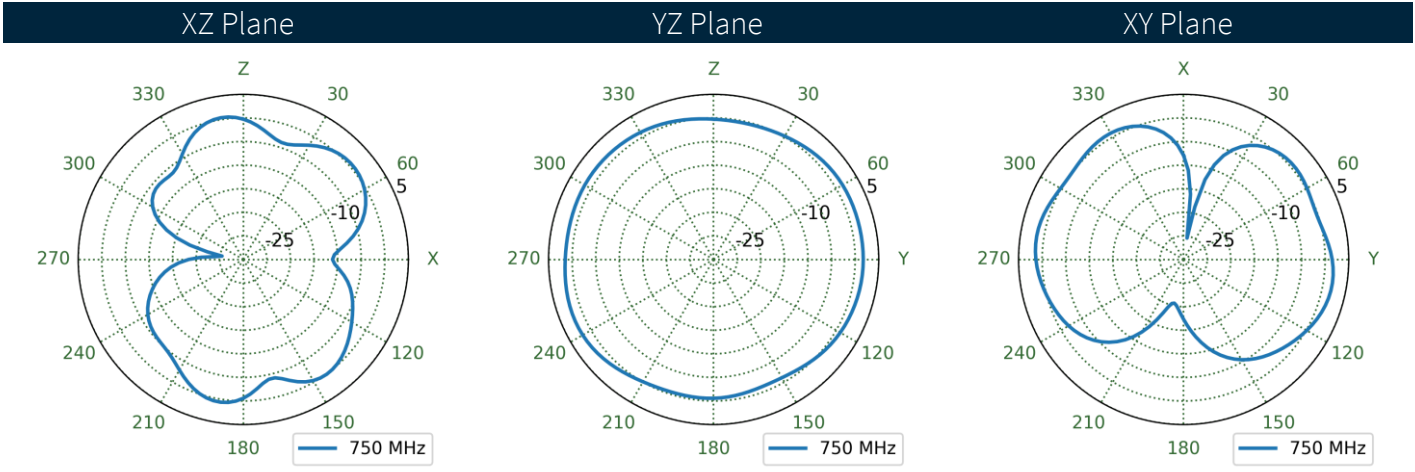
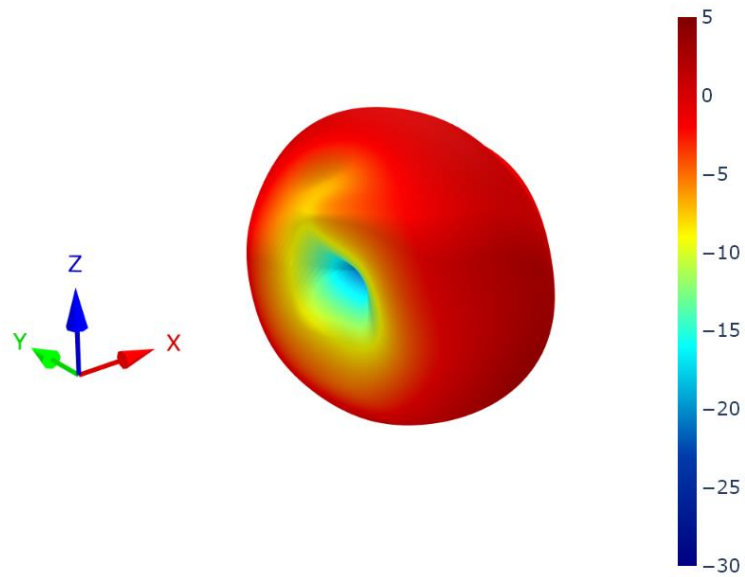

7.13 Straight Free Space Patterns at 750 MHz

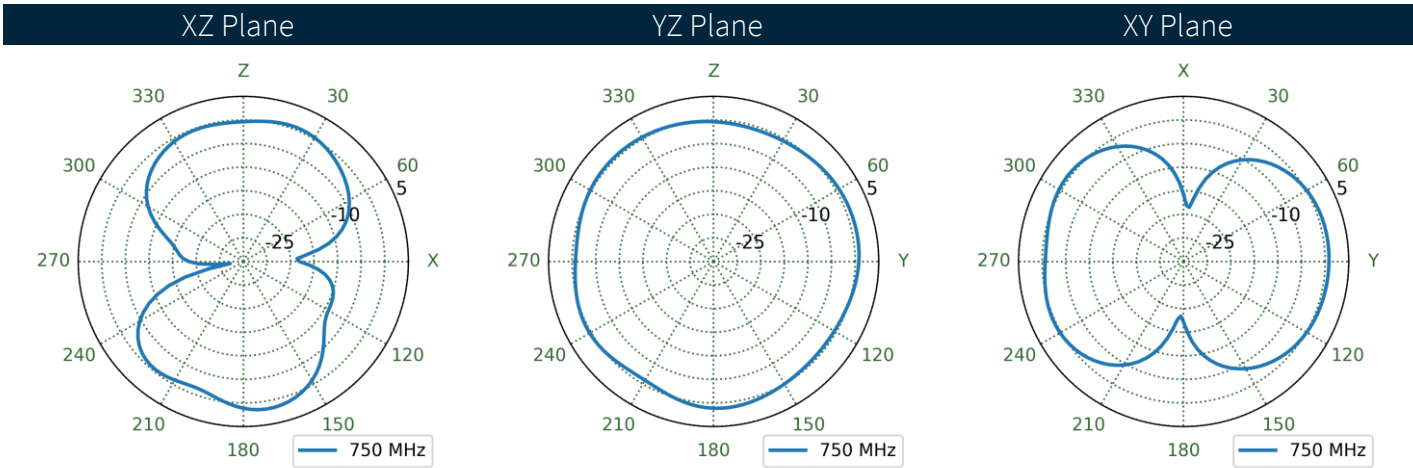
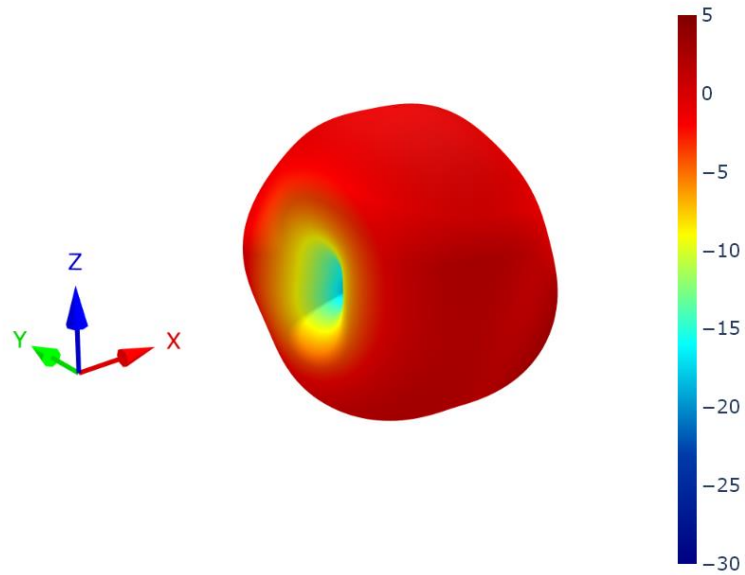

7.14 Bent Centre Ground Plane Patterns at 890 MHz

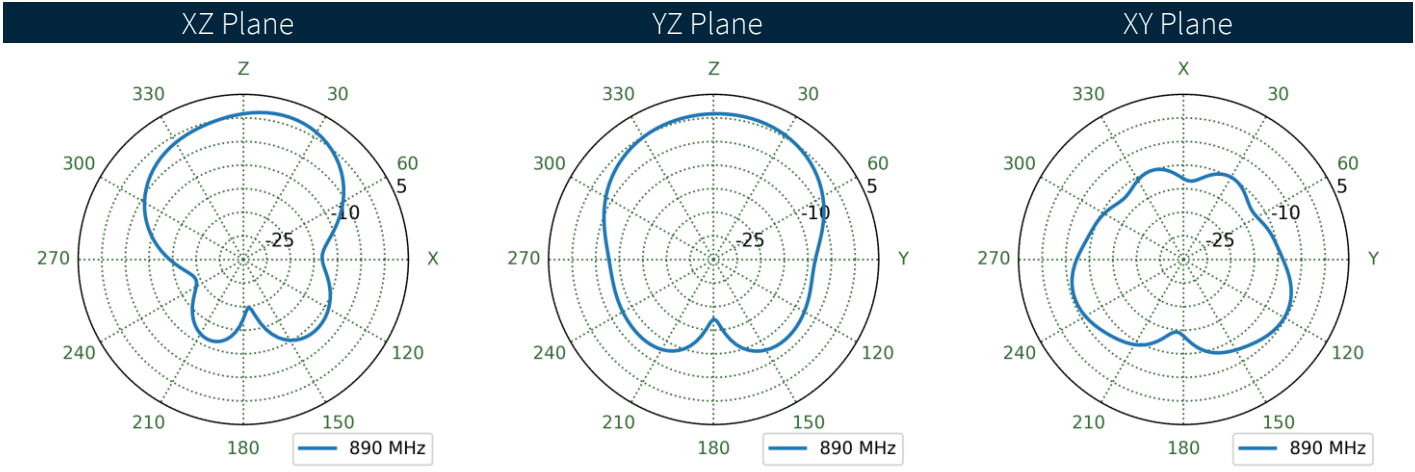
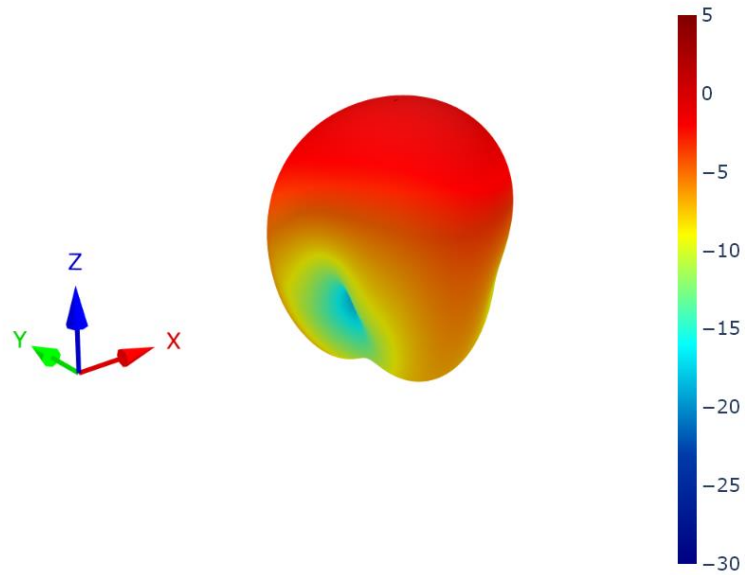

7.15 Bent Edge Ground Plane Patterns at 890 MHz

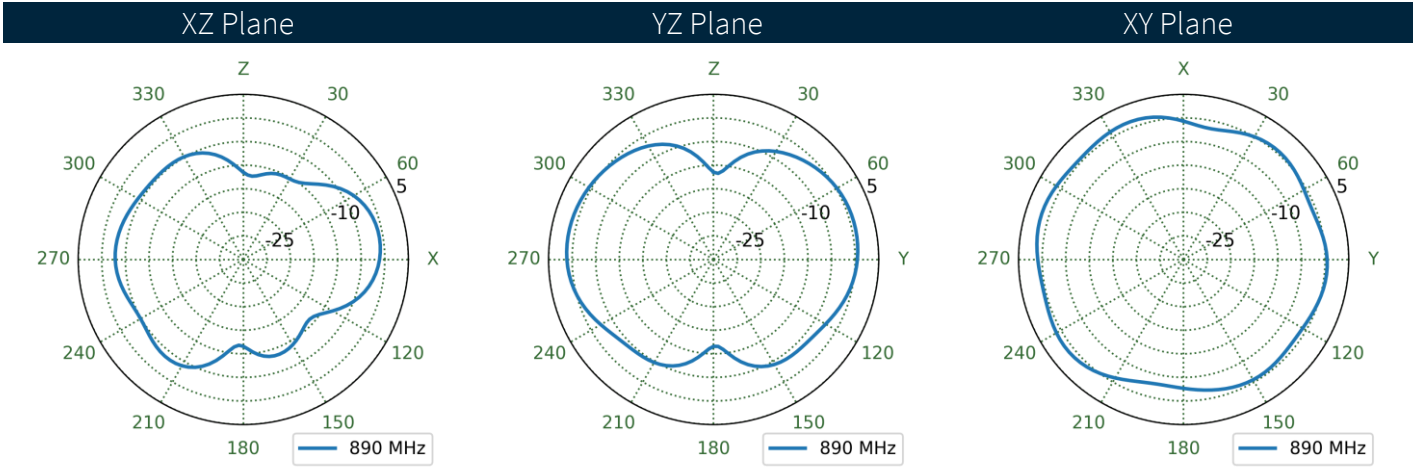
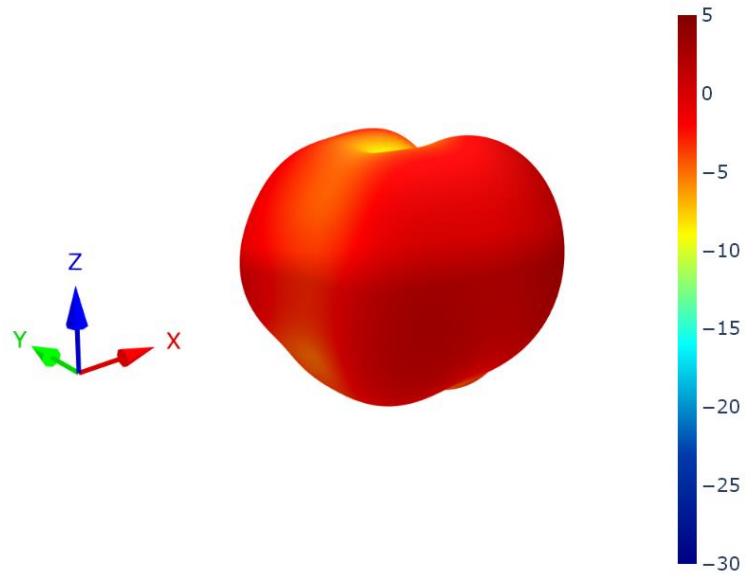

7.16 Bent Free Space Patterns at 890 MHz

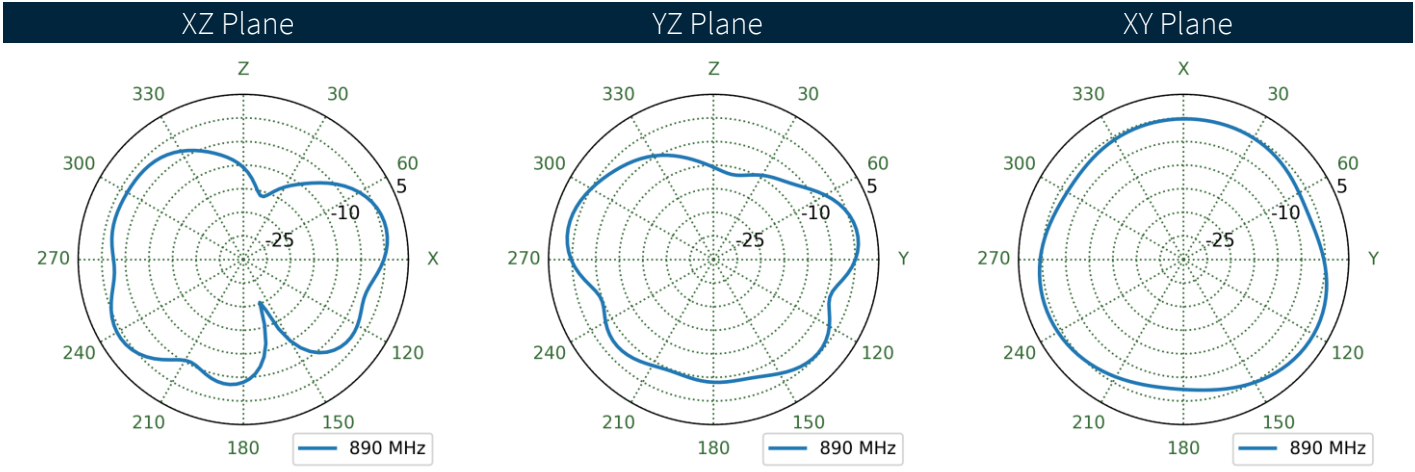
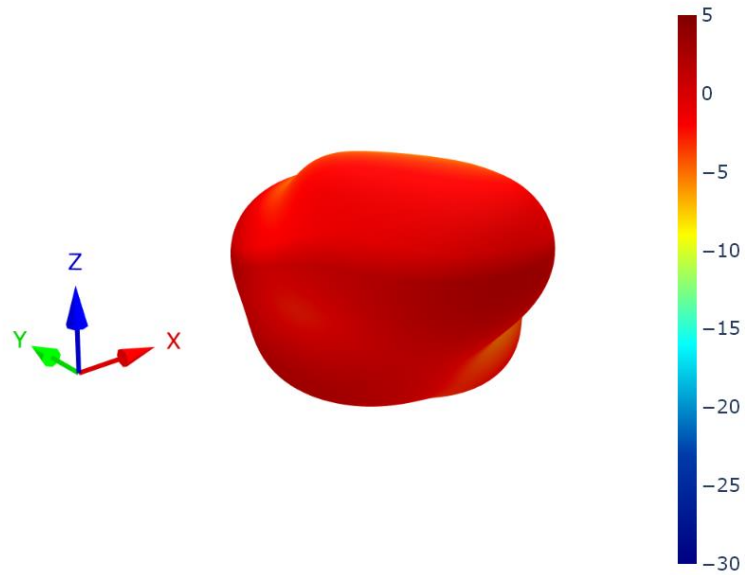

7.17 Straight Centre GroundPlane Patterns at 890 MHz

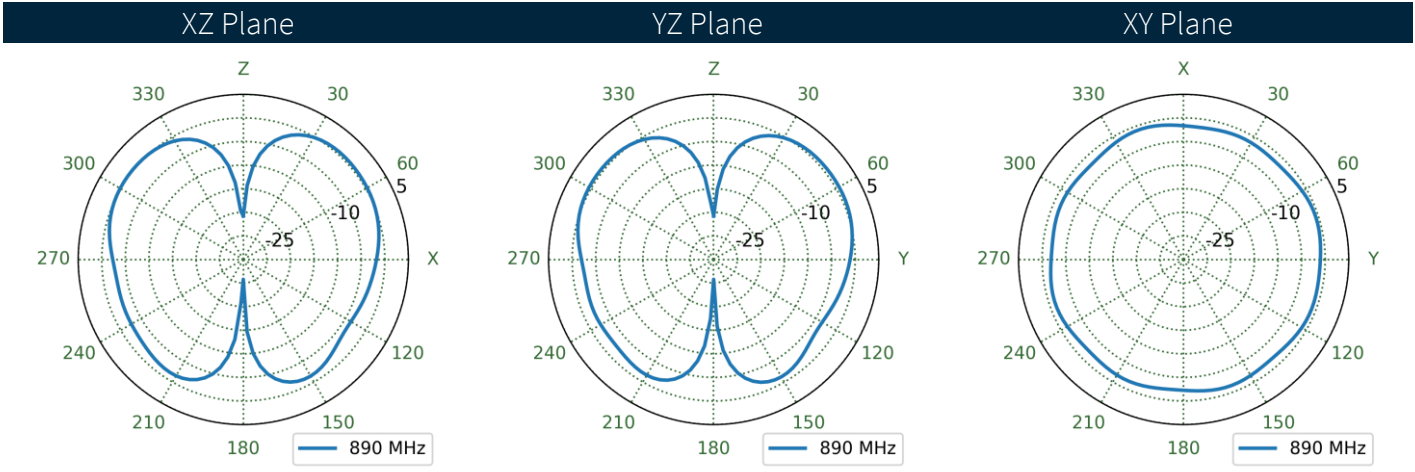
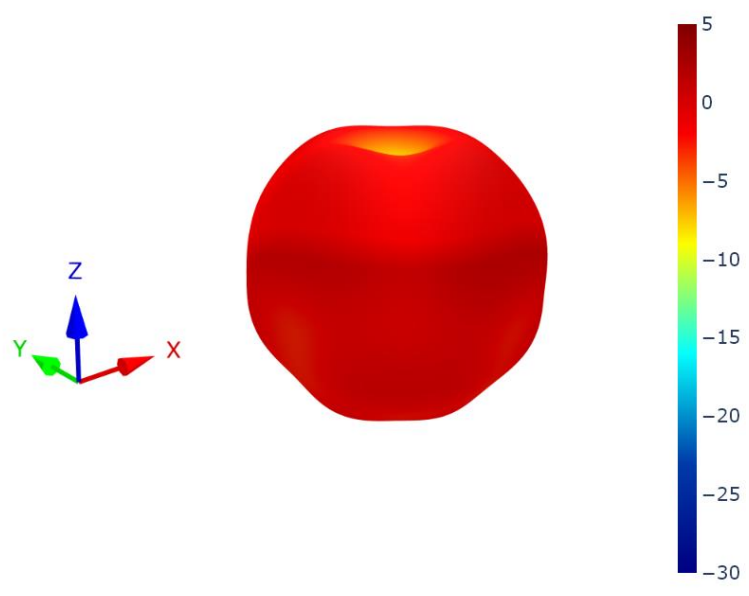

7.18 Straight Edge Ground Plane Patterns at 890 MHz

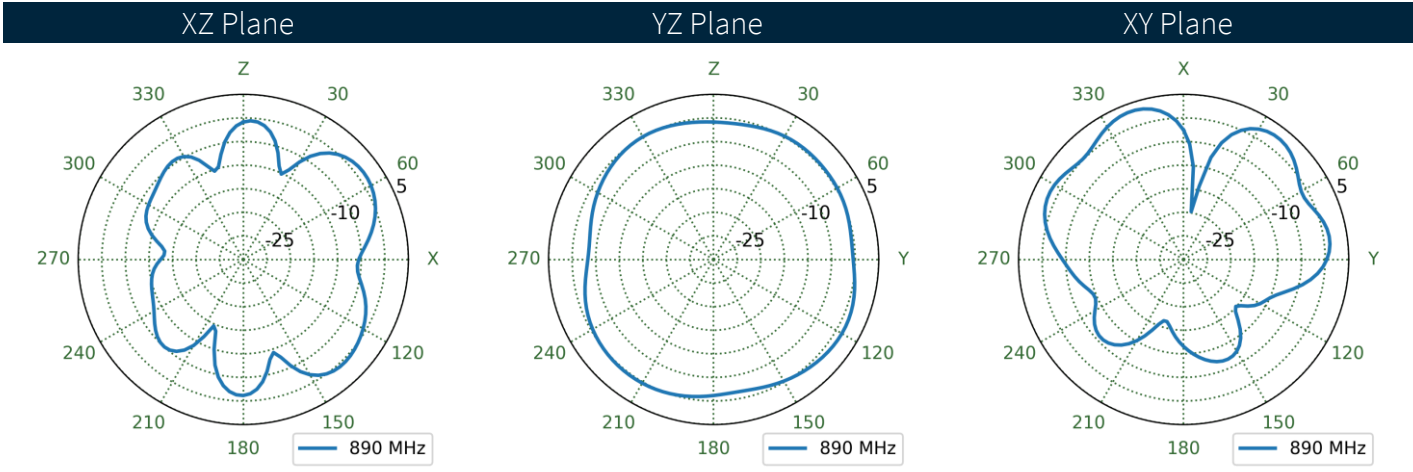
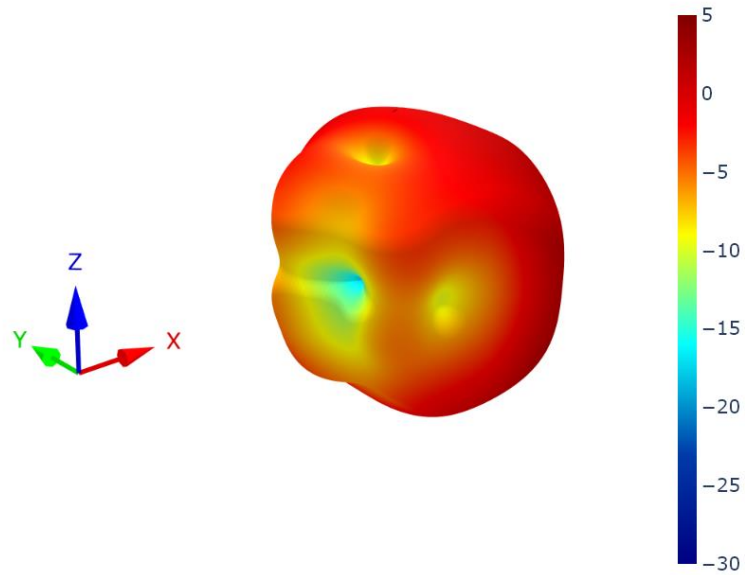

7.19 Straight Free Space Patterns at 890 MHz

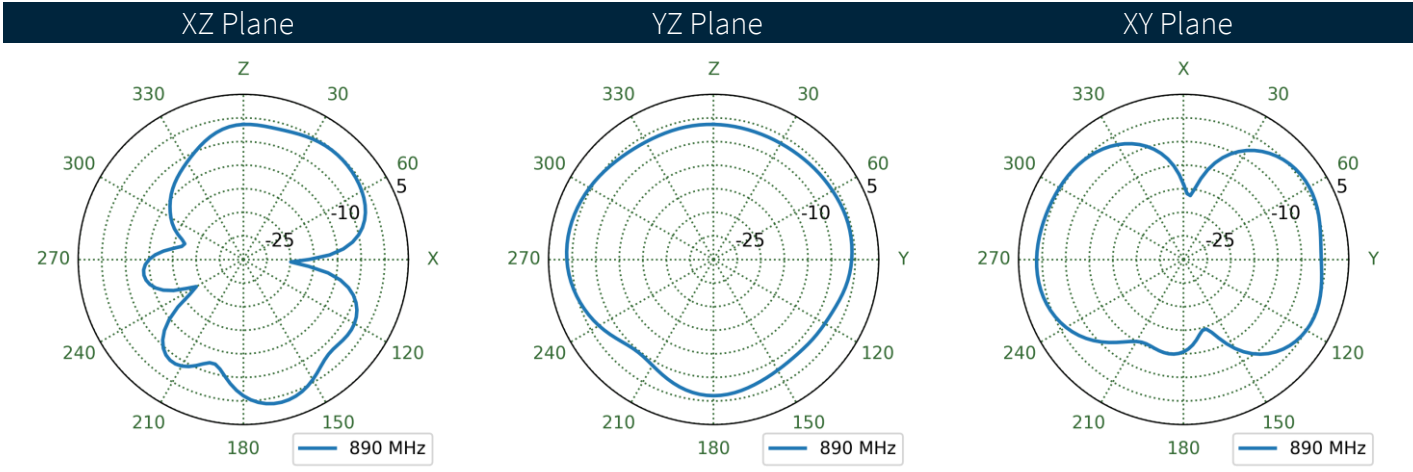
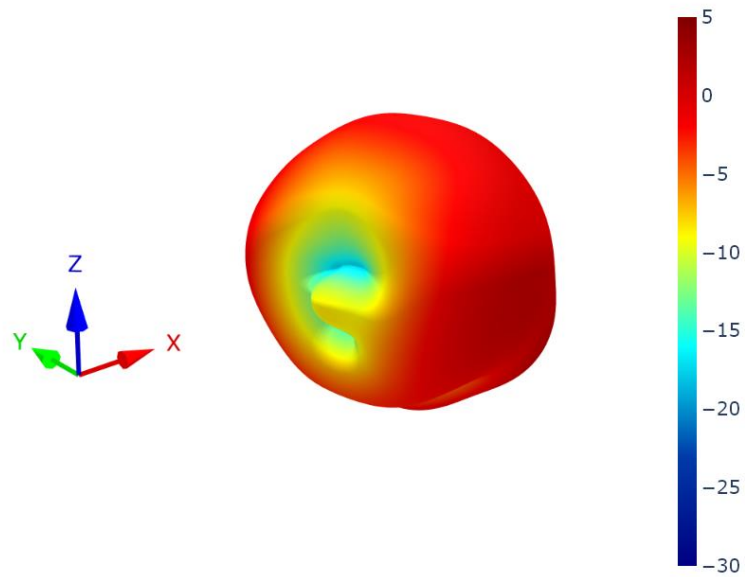

7.20 Bent Centre Ground Plane Patterns at 1475 MHz

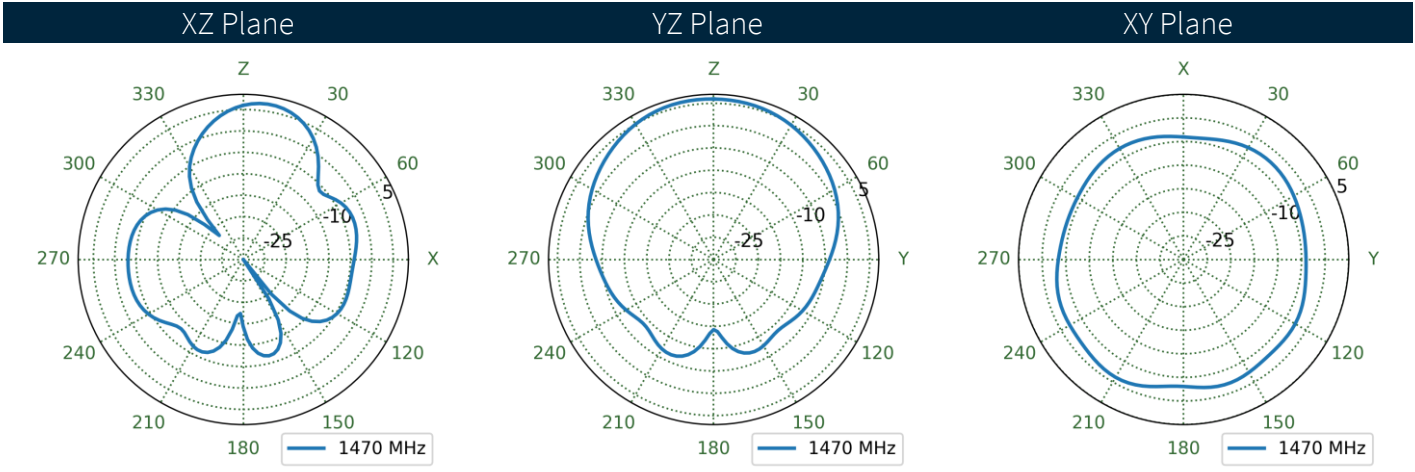
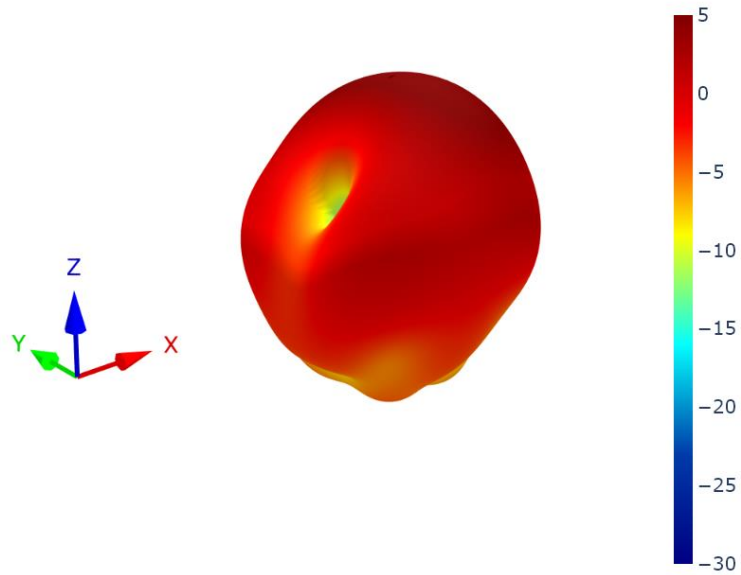

7.21 Bent Edge Ground Plane Patterns at 1475 MHz

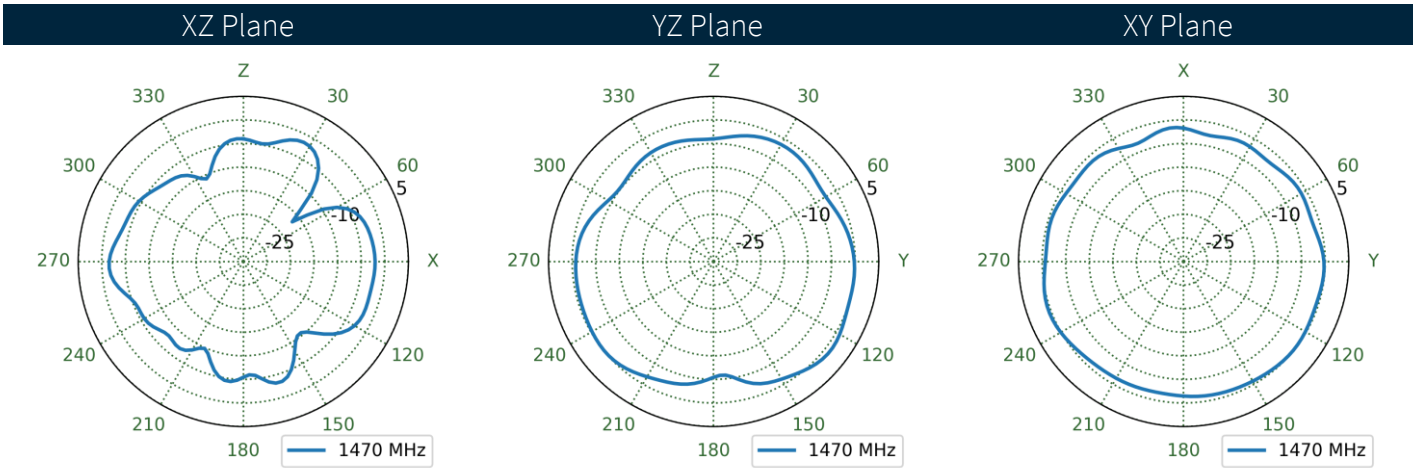
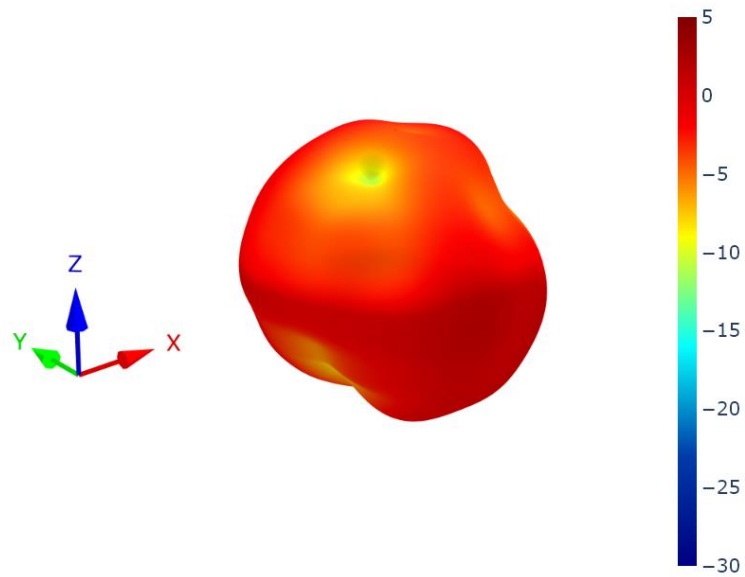

7.22 Bent Free Space Patterns at 1475 MHz

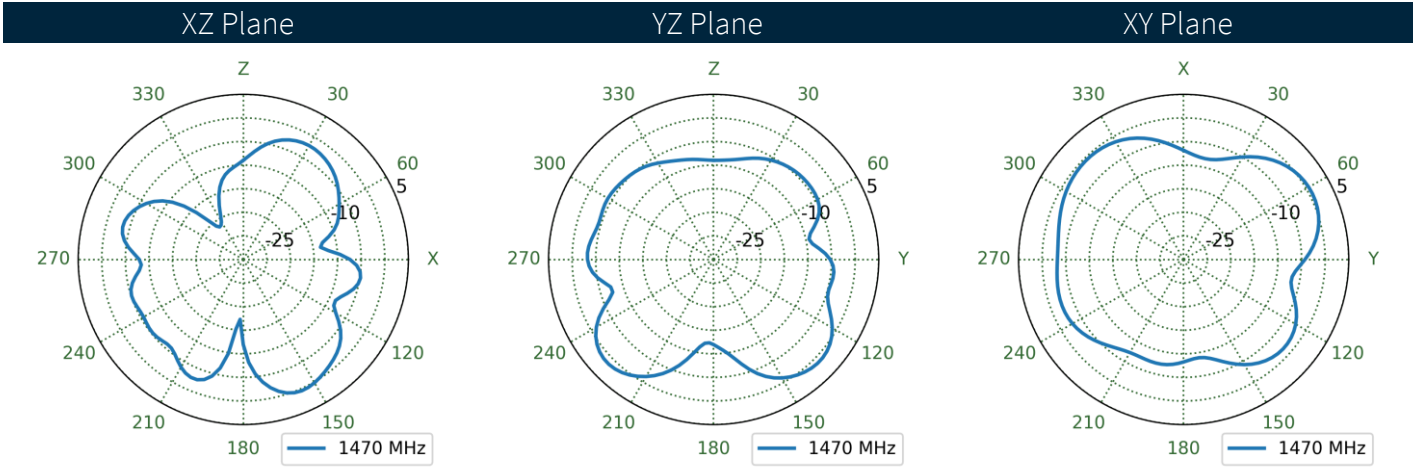
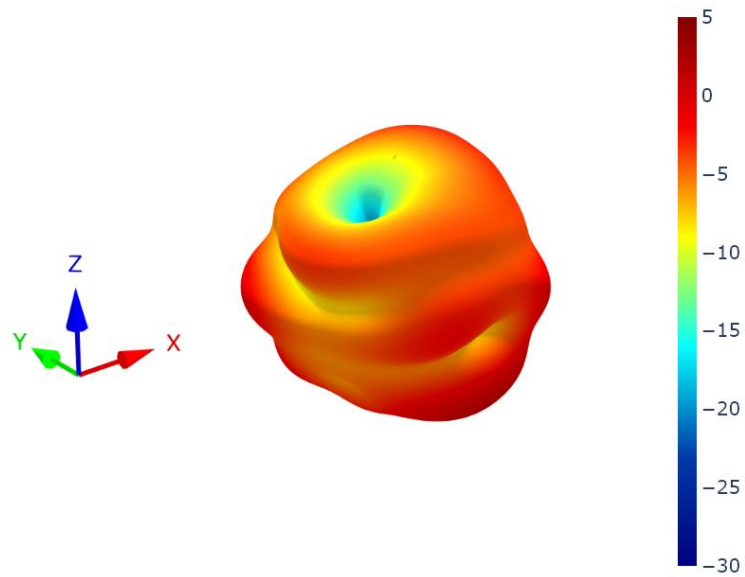

7.23 Straight Centre GroundPlane Patterns at 1475 MHz

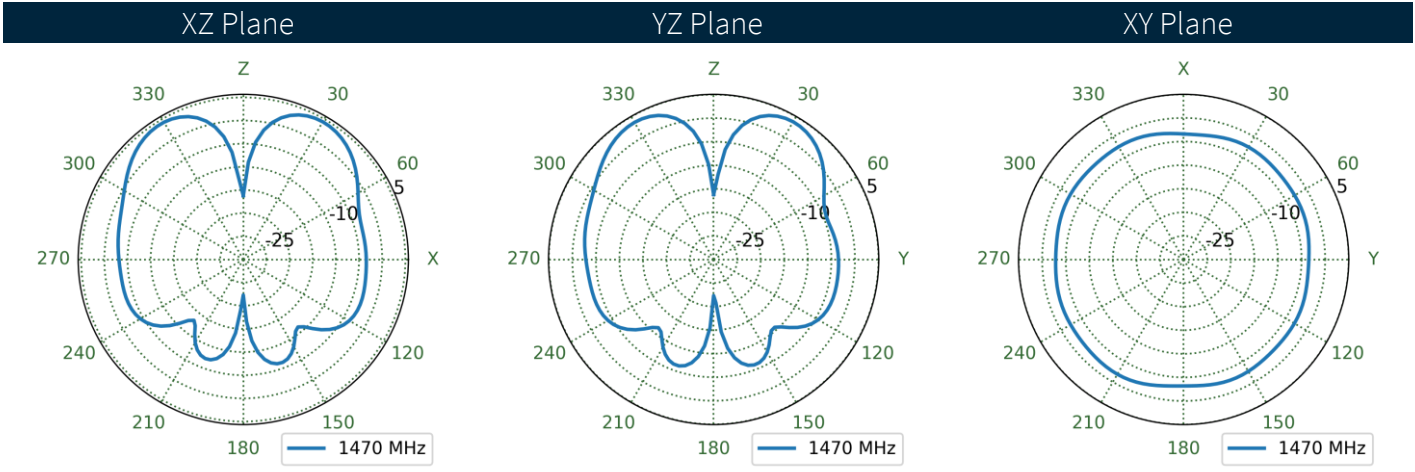
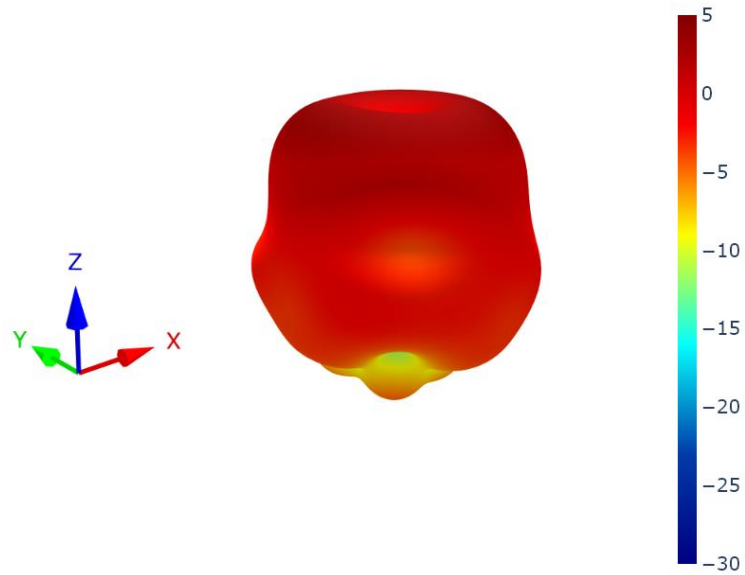

7.24 Straight Edge Ground Plane Patterns at 1475 MHz

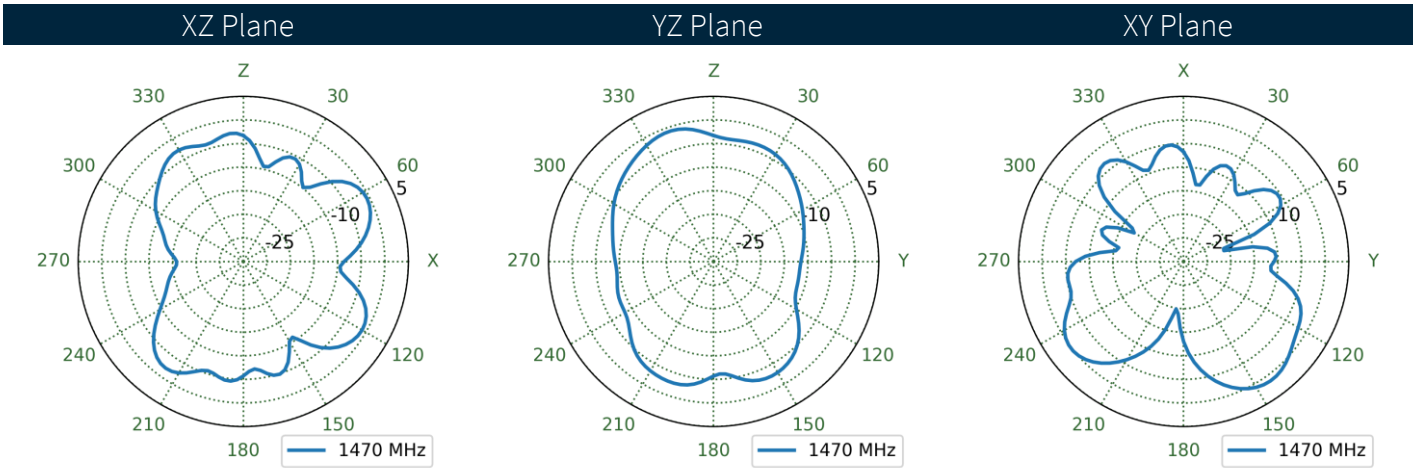
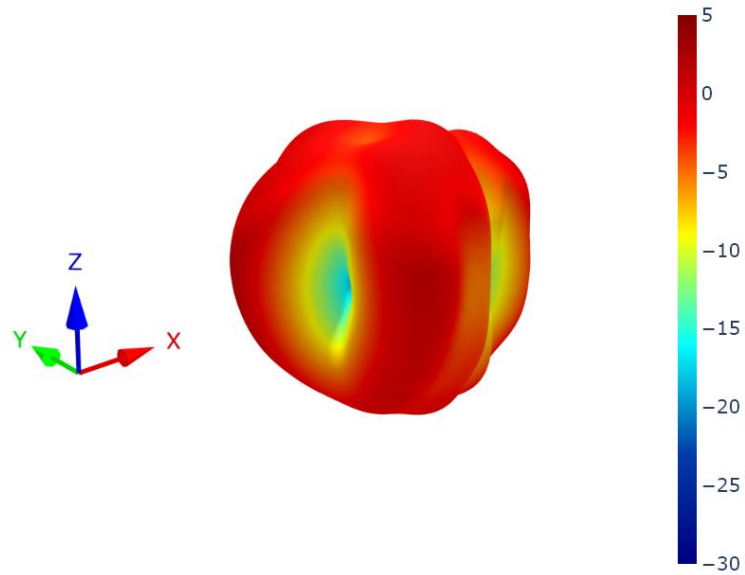

7.25 Straight Free Space Patterns at 1475 MHz

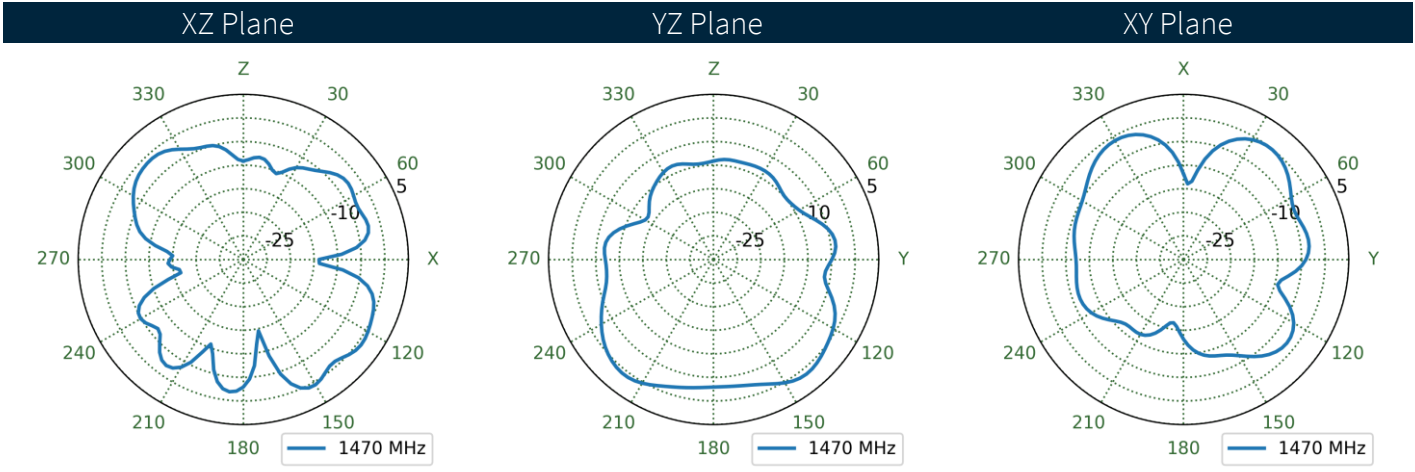
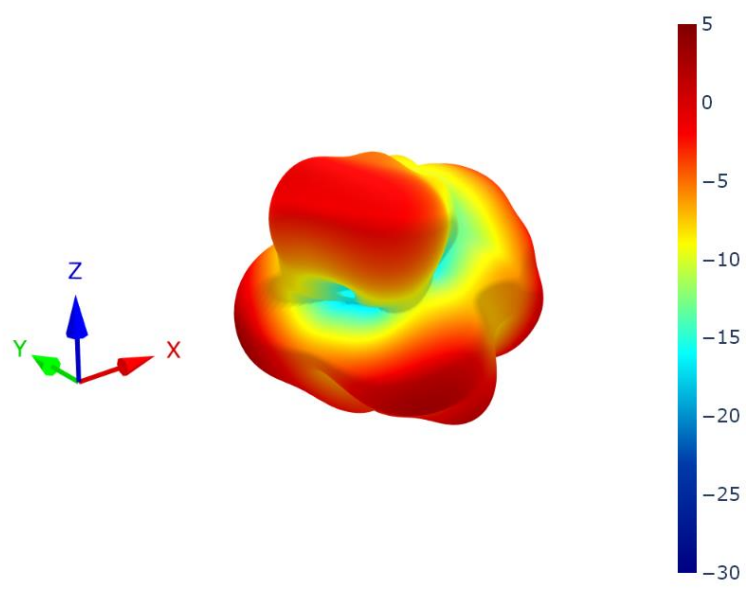

7.26 Bent Centre Ground Plane Patterns at 1955 MHz

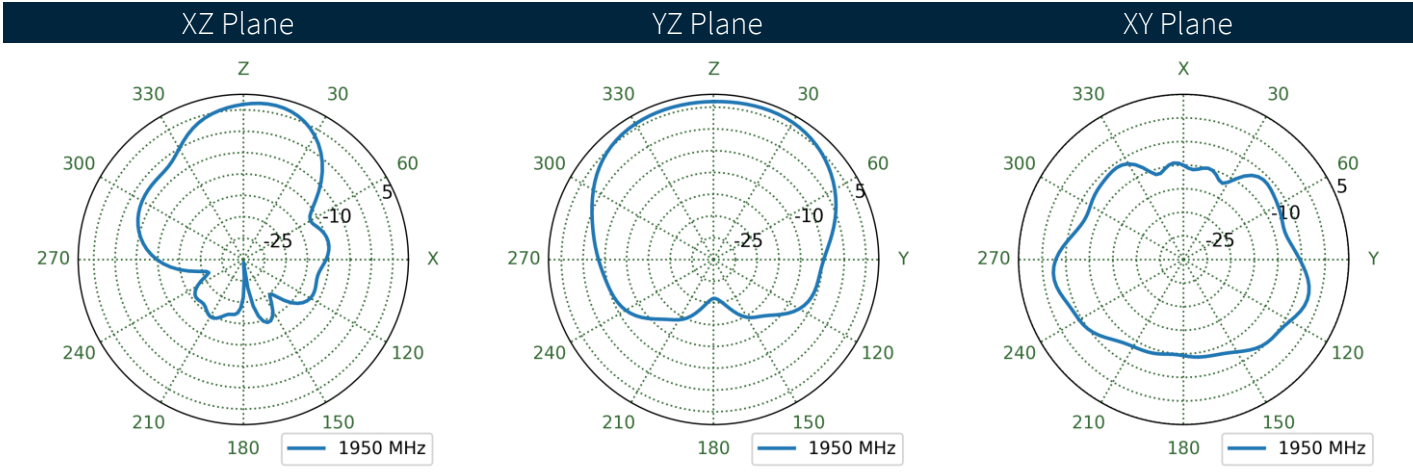
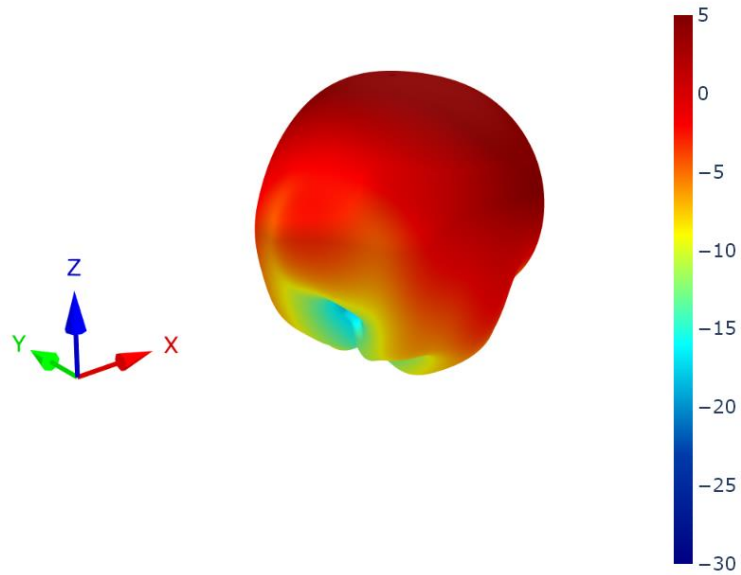

7.27 Bent Edge Ground Plane Patterns at 1955 MHz

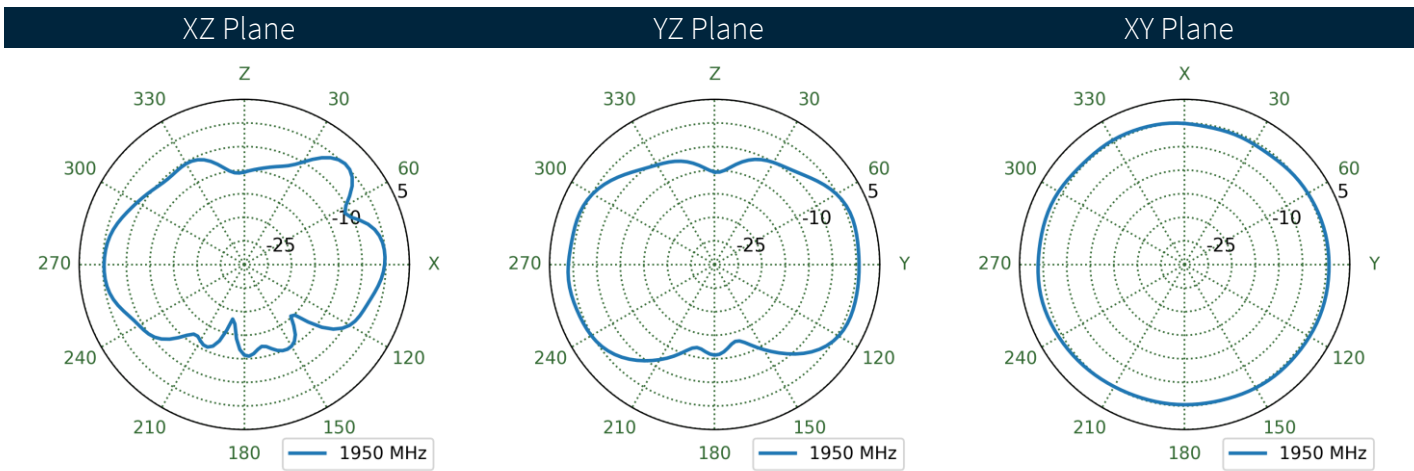
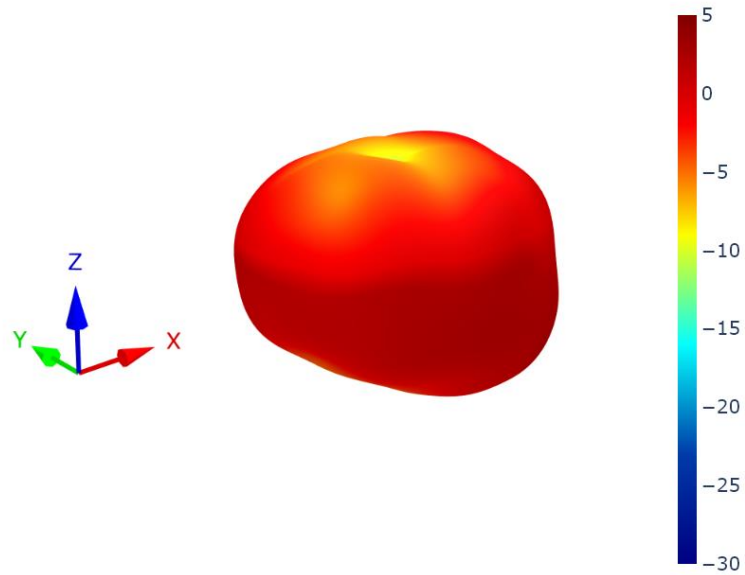

7.28 Bent Free Space Patterns at 1955 MHz

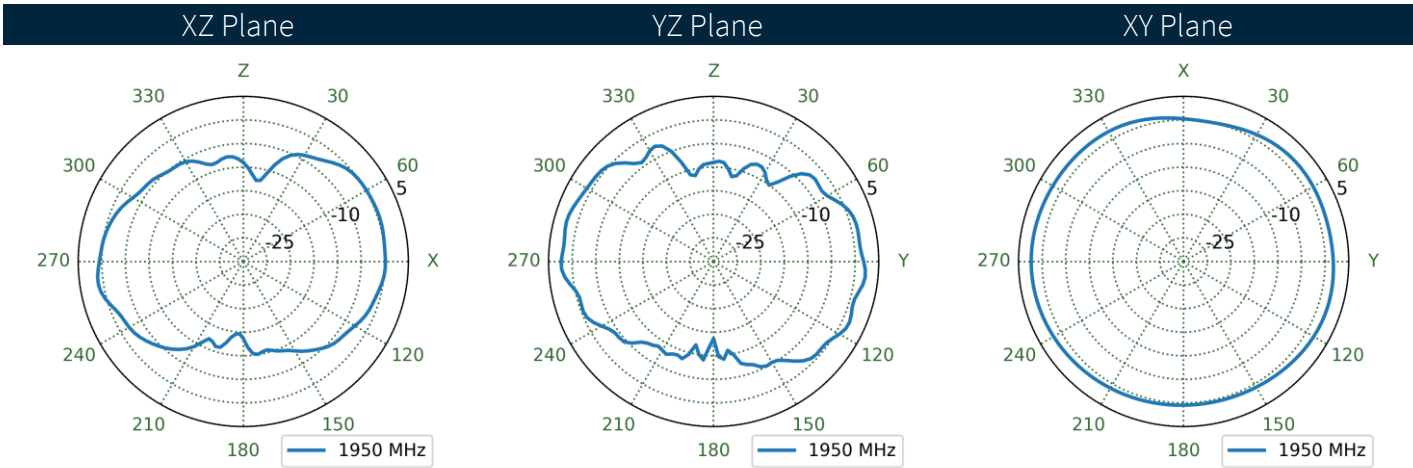
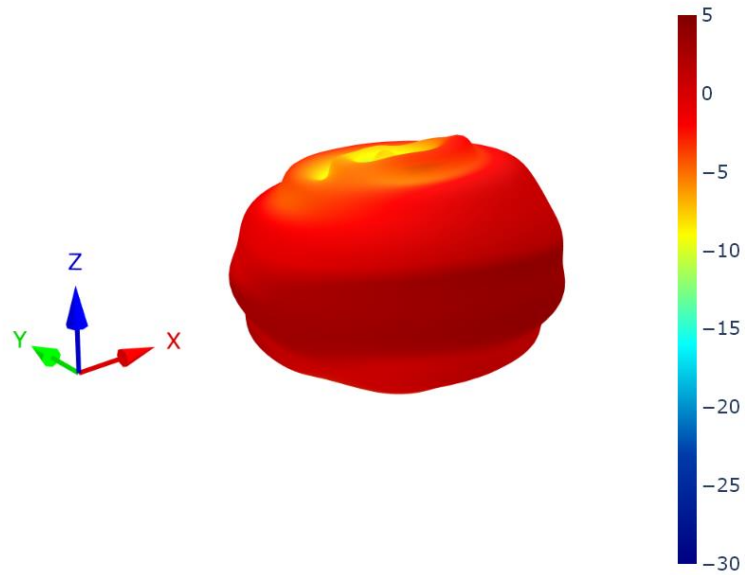

7.29 Straight Centre GroundPlane Patterns at 1955 MHz

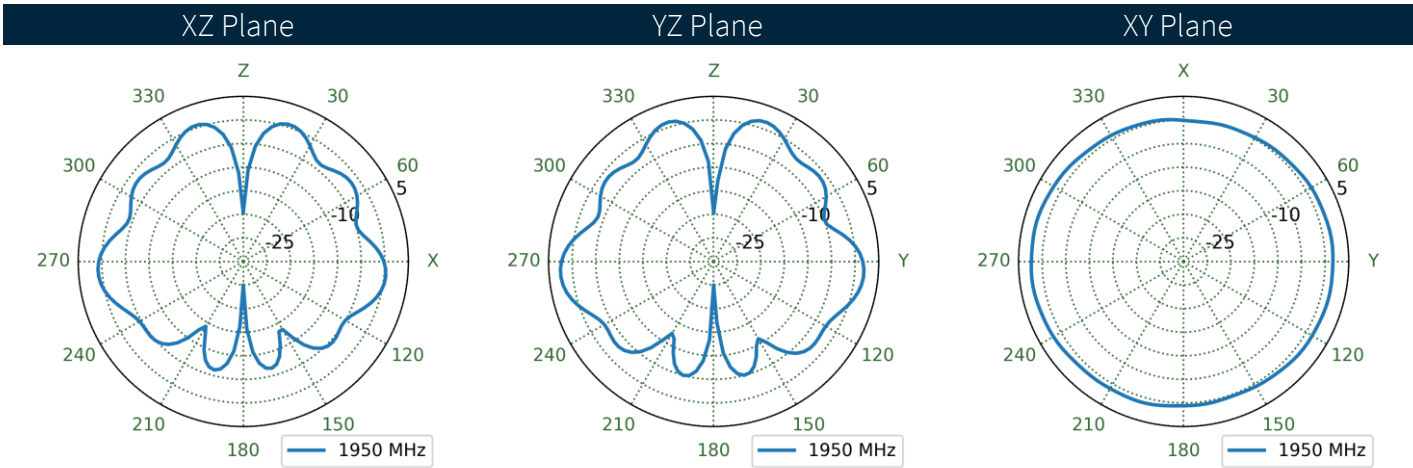
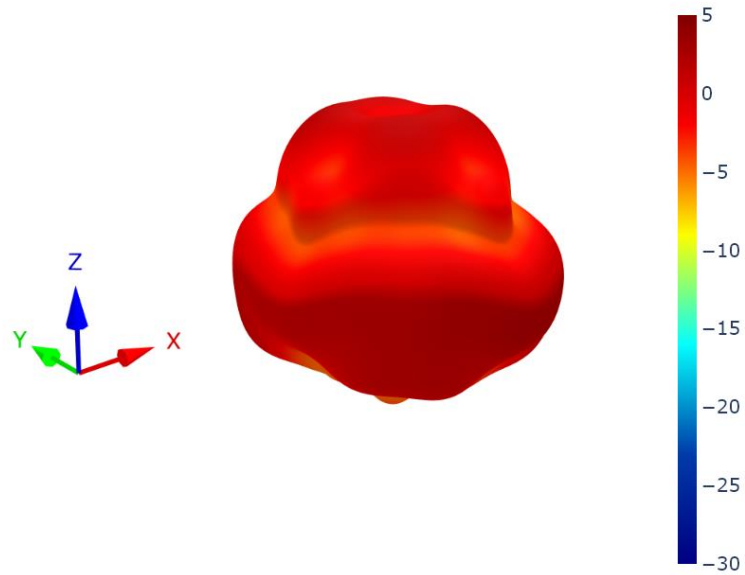

7.30 Straight Edge Ground Plane Patterns at 1955 MHz

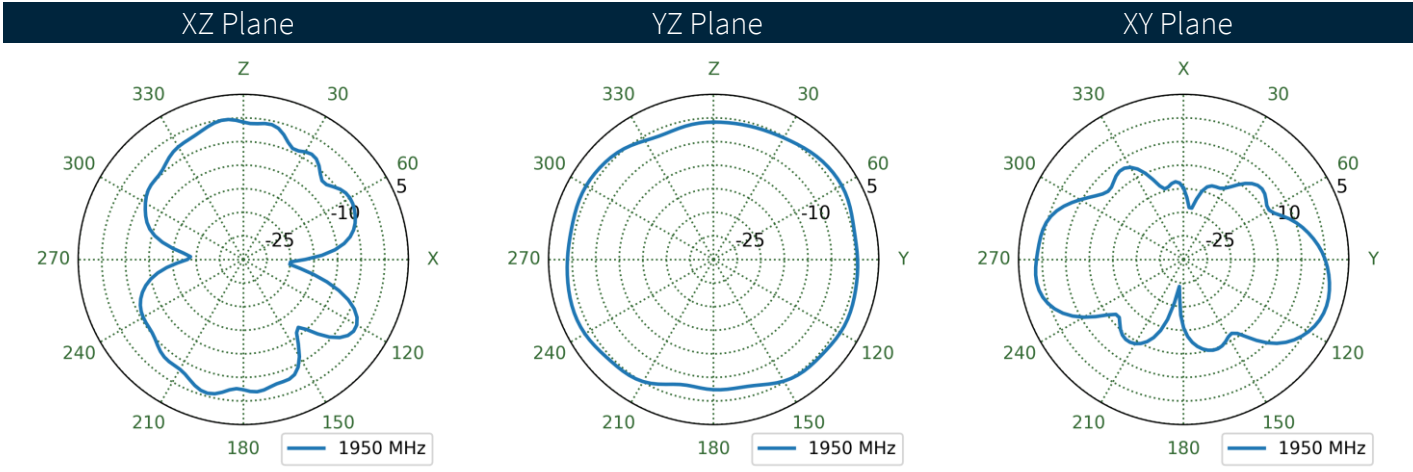
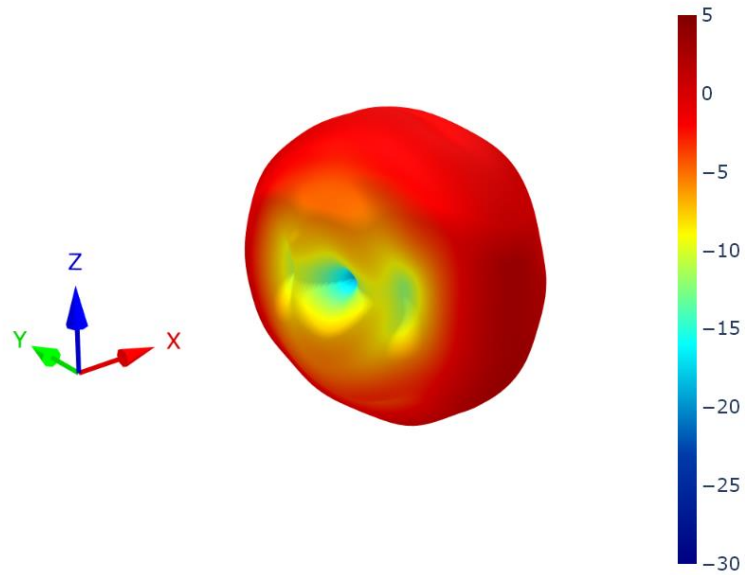

7.31 Straight Free Space Patterns at 1955 MHz

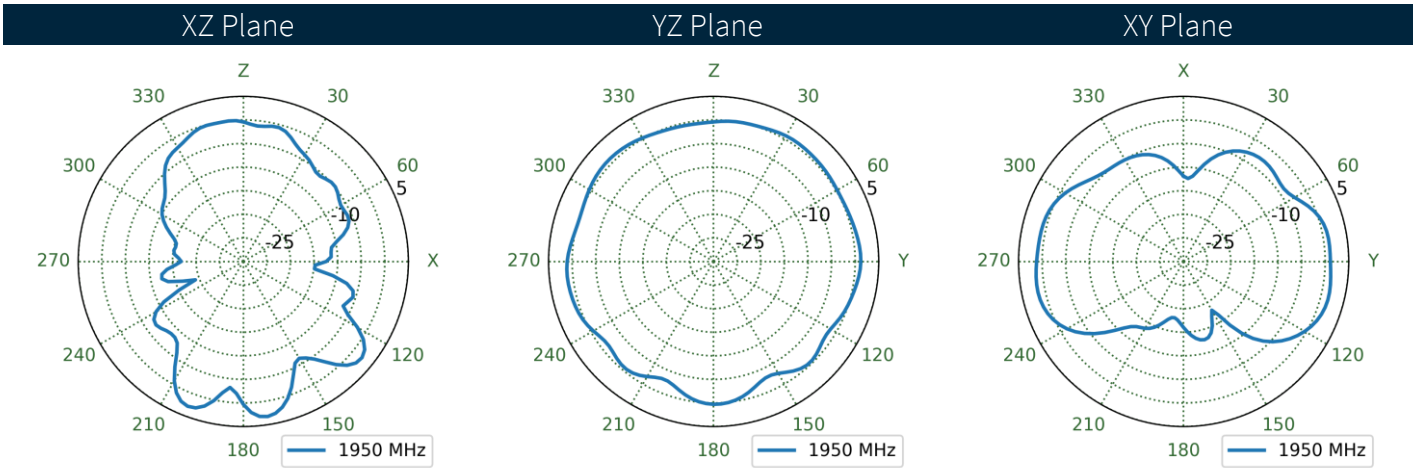
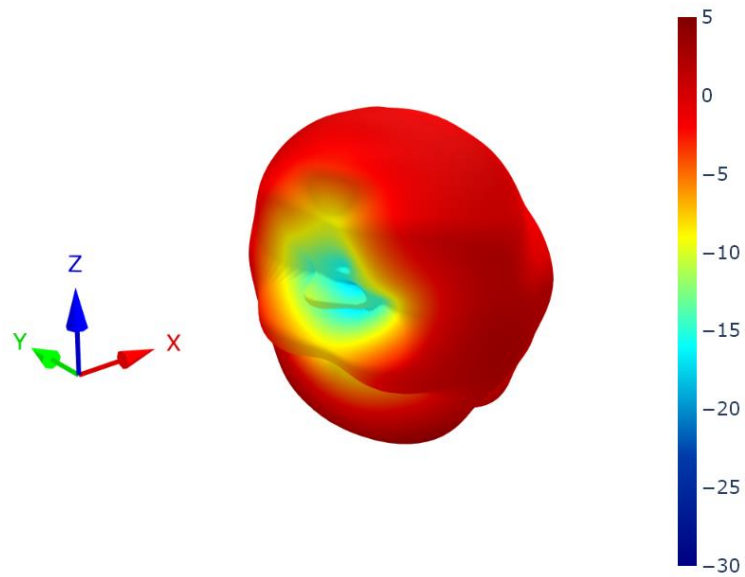

7.32 Bent Centre Ground Plane Patterns at 2495 MHz

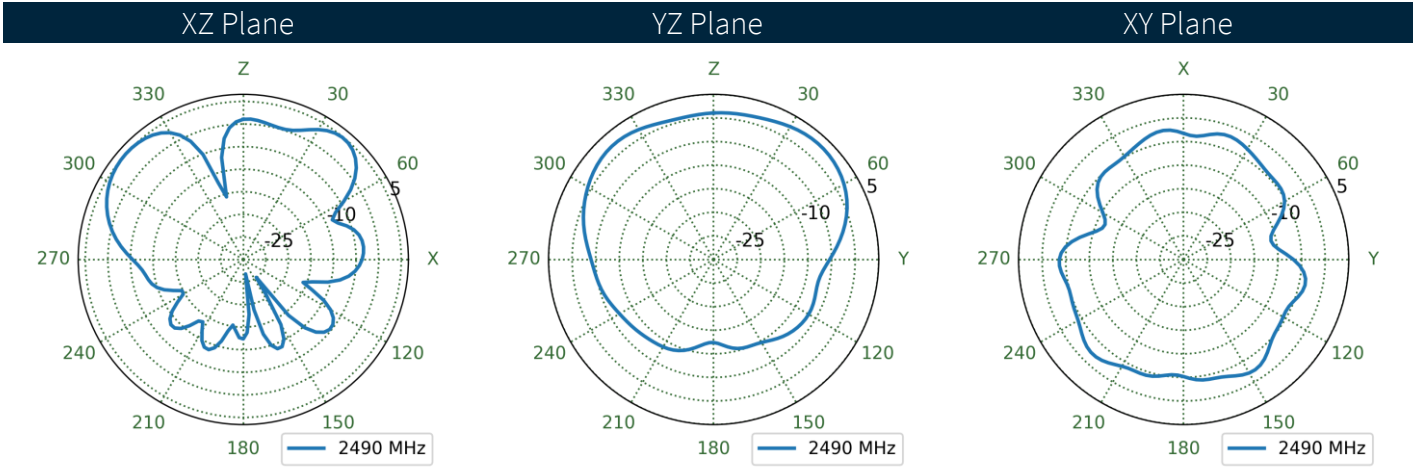
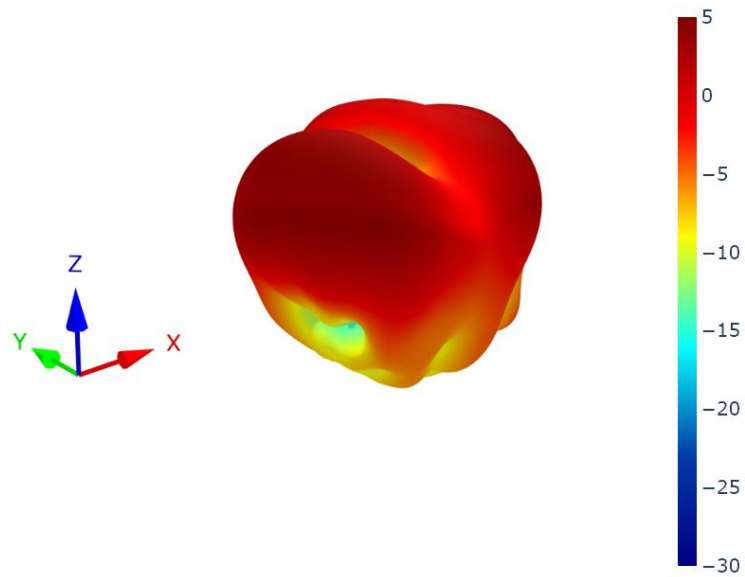

7.33 Bent Edge Ground Plane Patterns at 2495 MHz

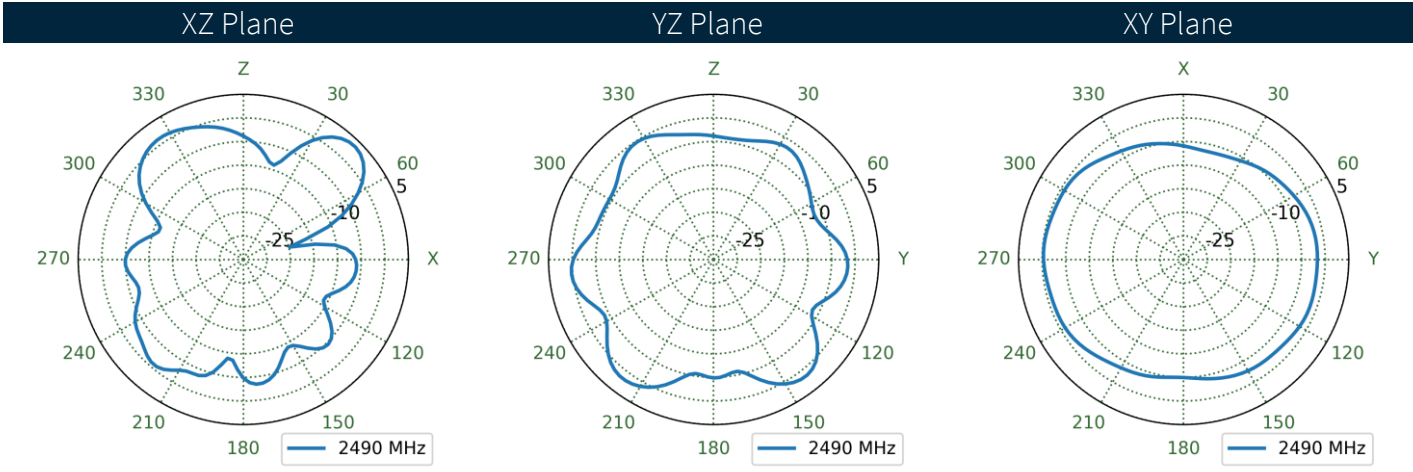
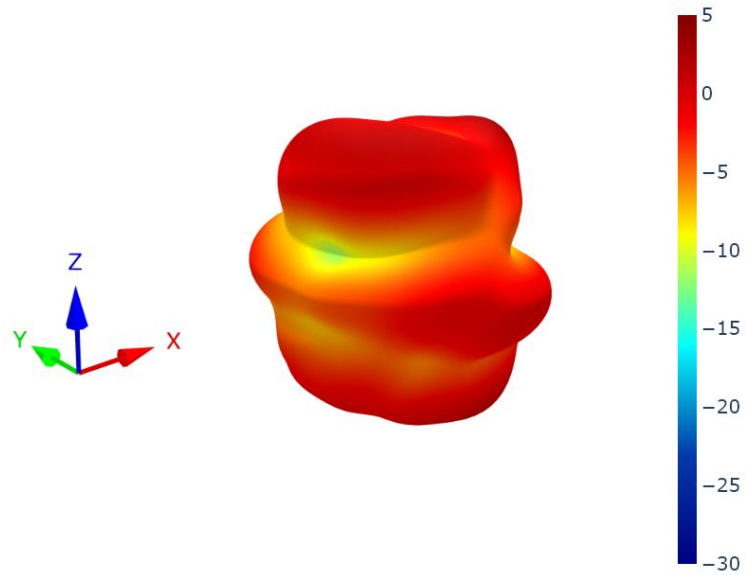

7.34 Bent Free Space Patterns at 2495 MHz

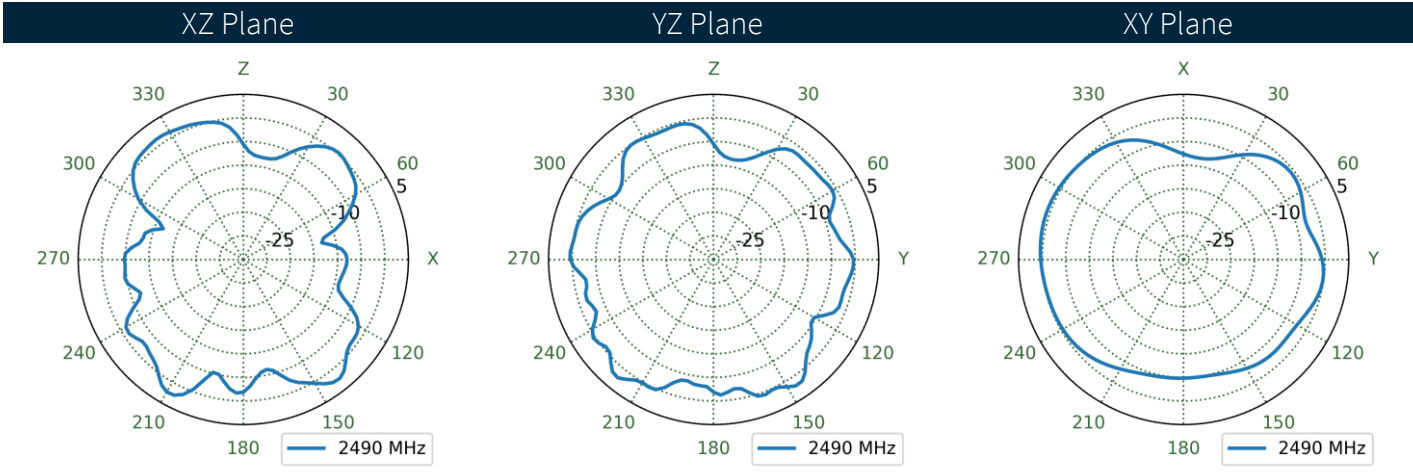
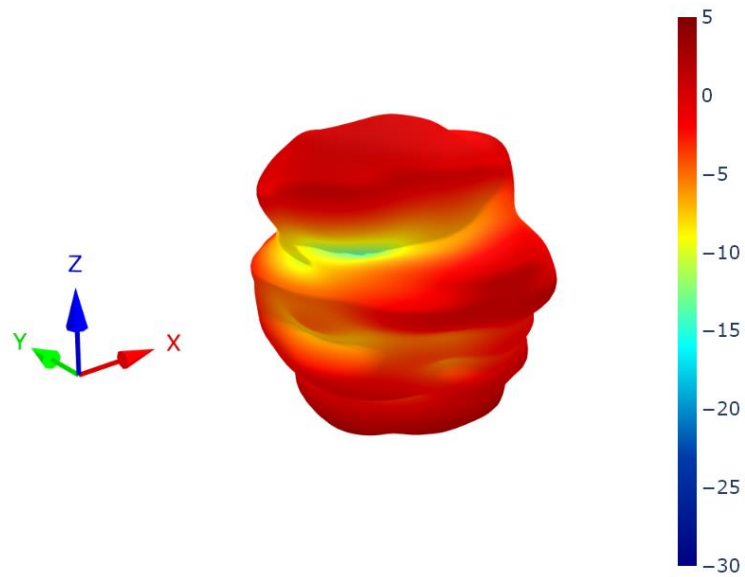

7.35 Straight Centre GroundPlane Patterns at 2495 MHz

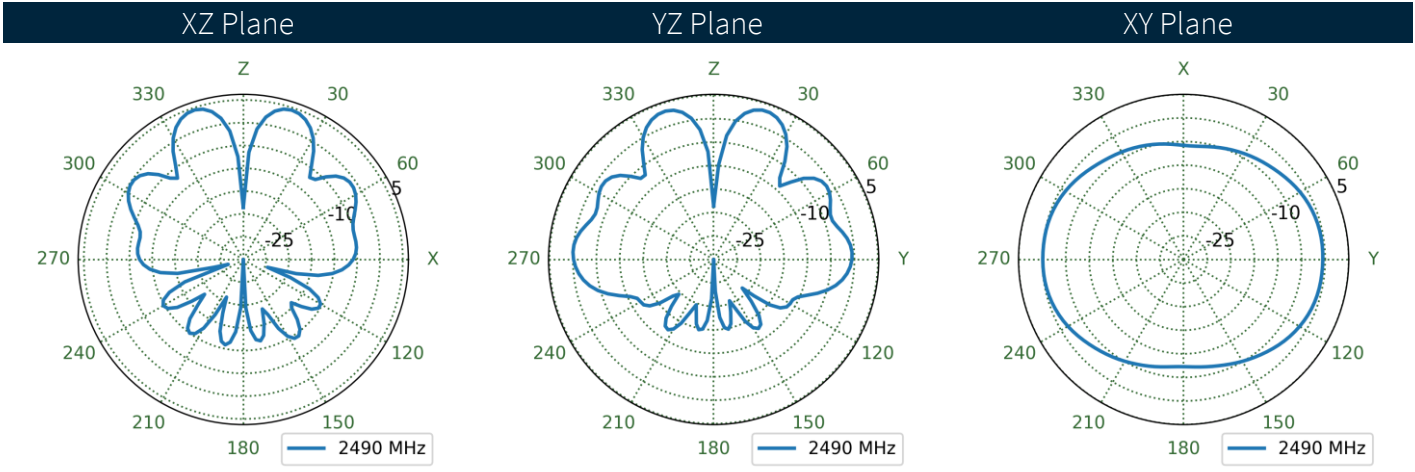
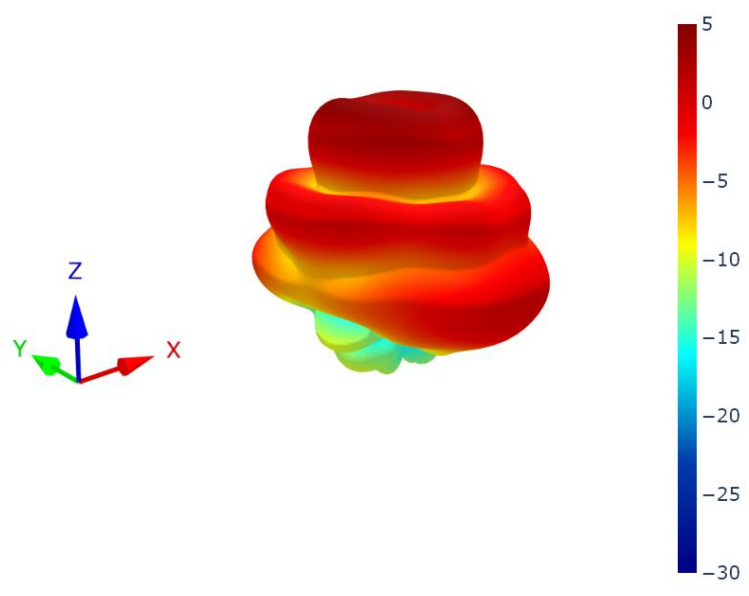

7.36 Straight Edge Ground Plane Patterns at 2495 MHz

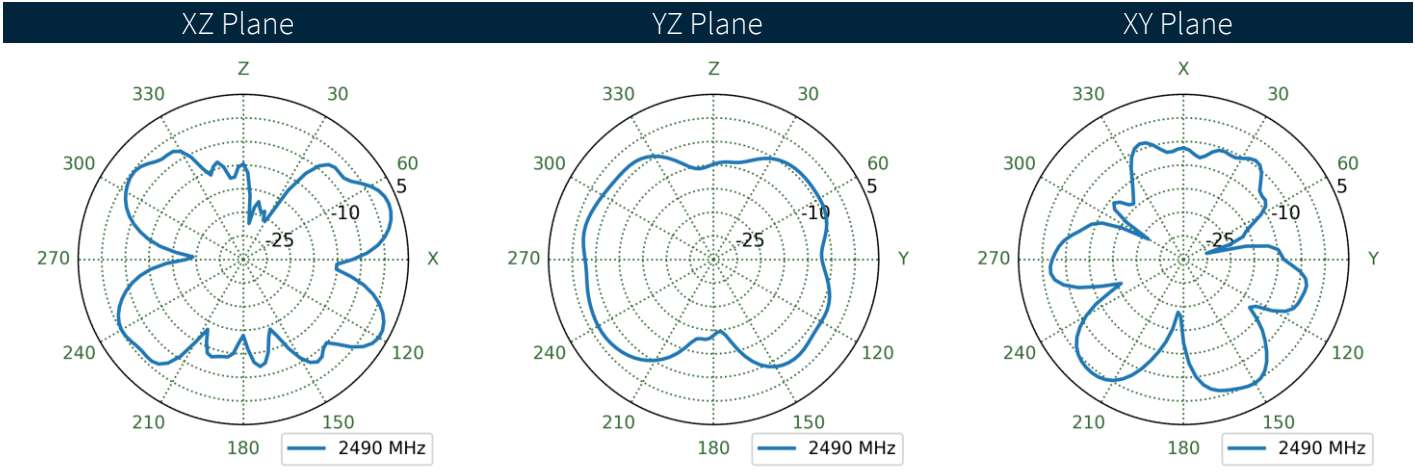
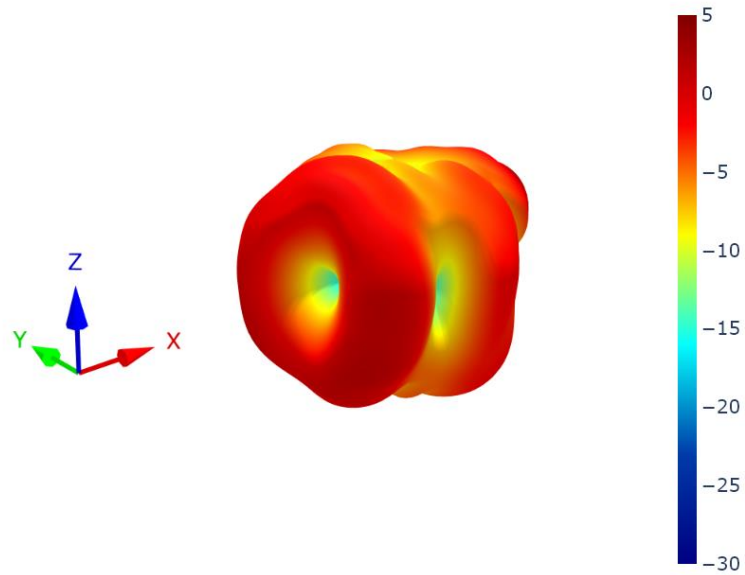

7.37 Straight Free Space Patterns at 2495 MHz

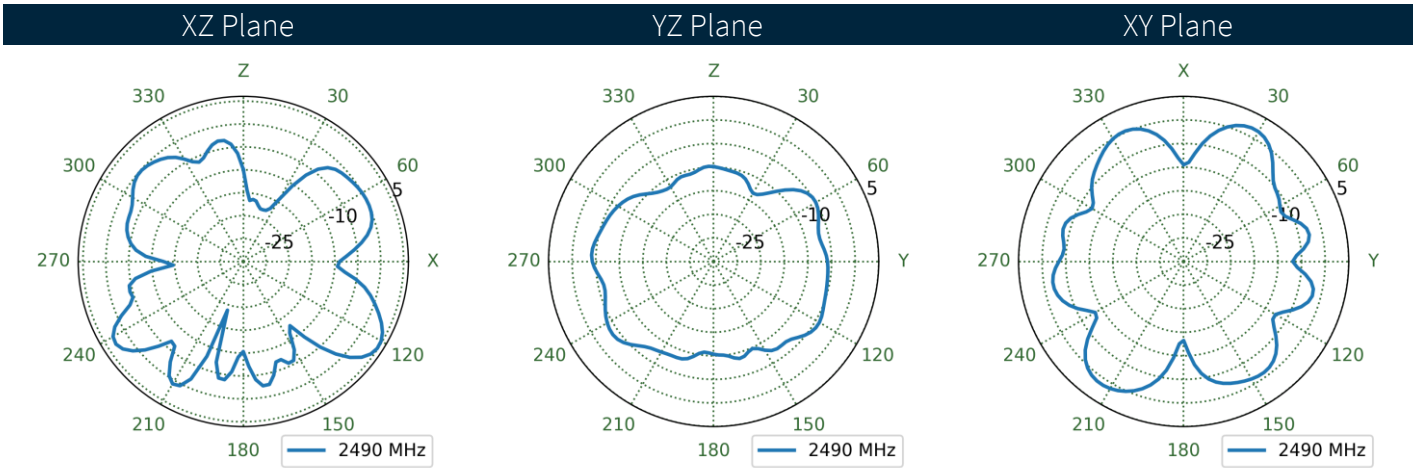
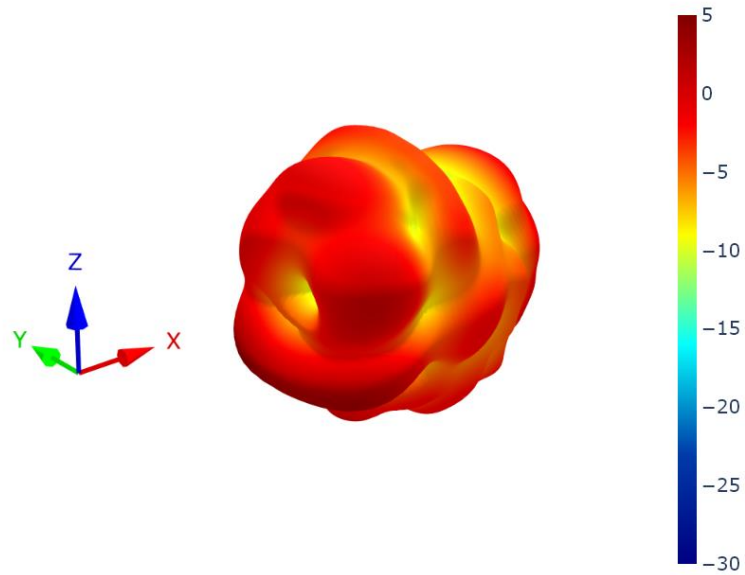

7.38 Bent Centre Ground Plane Patterns at 3550 MHz

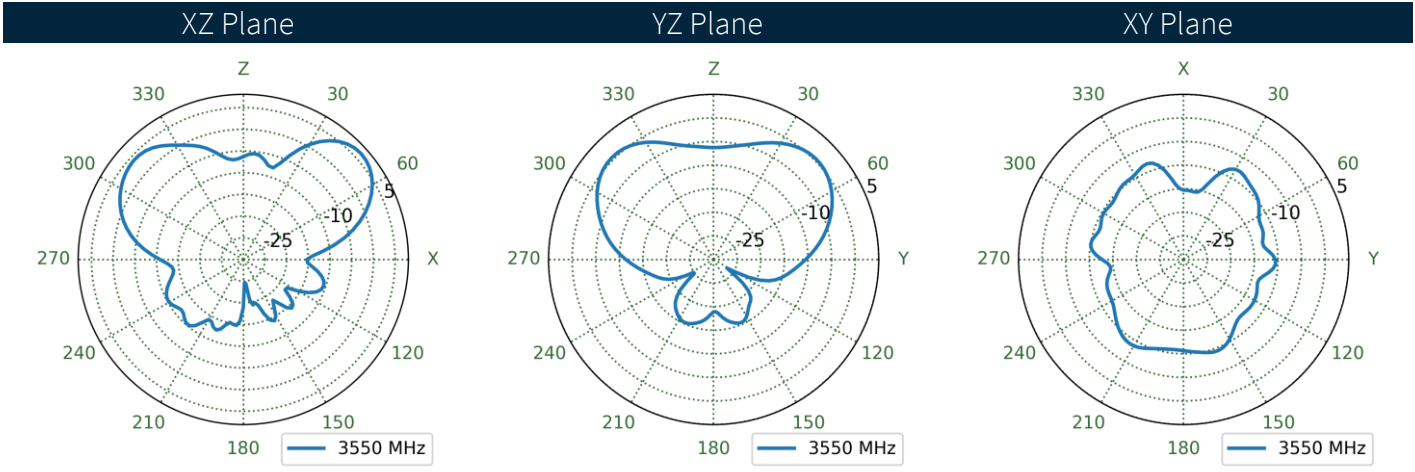
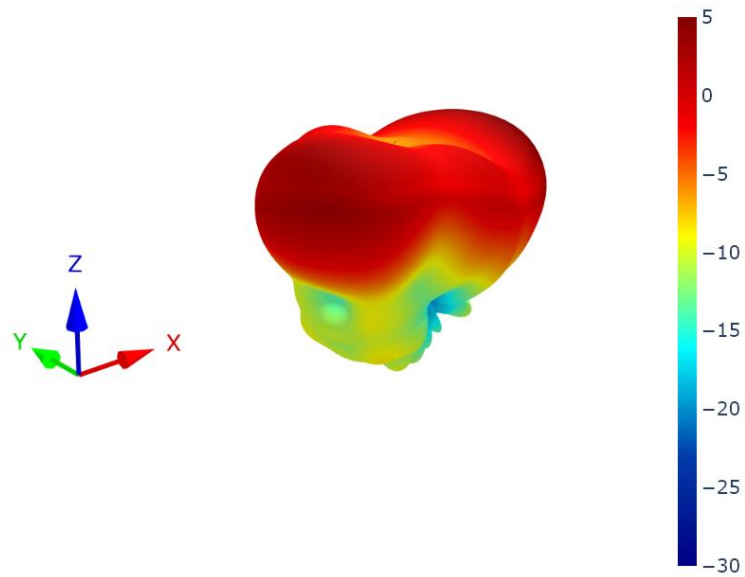

7.39 Bent Edge Ground Plane Patterns at 3550 MHz

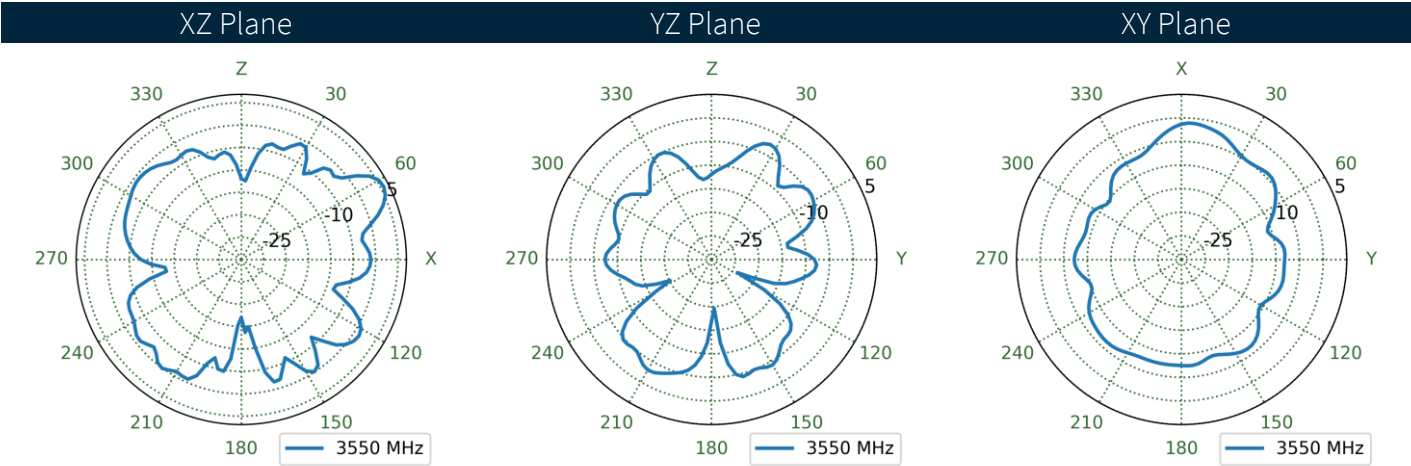
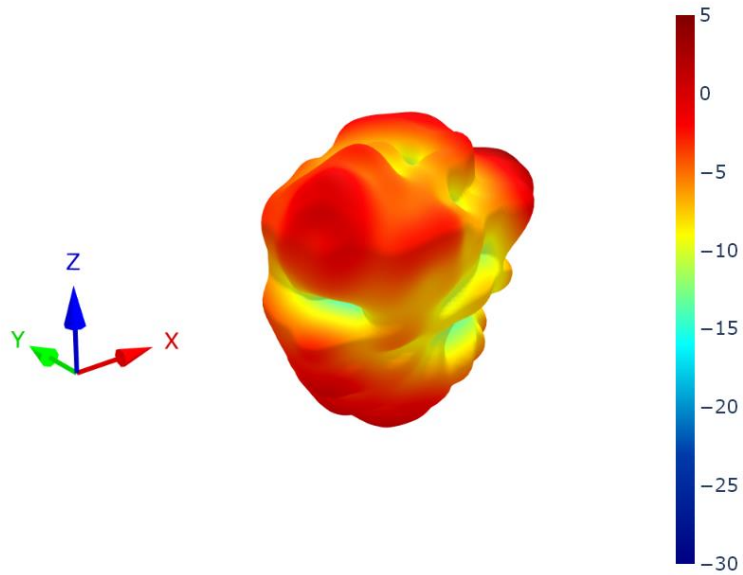

7.40 Bent Free Space Patterns at 3550 MHz

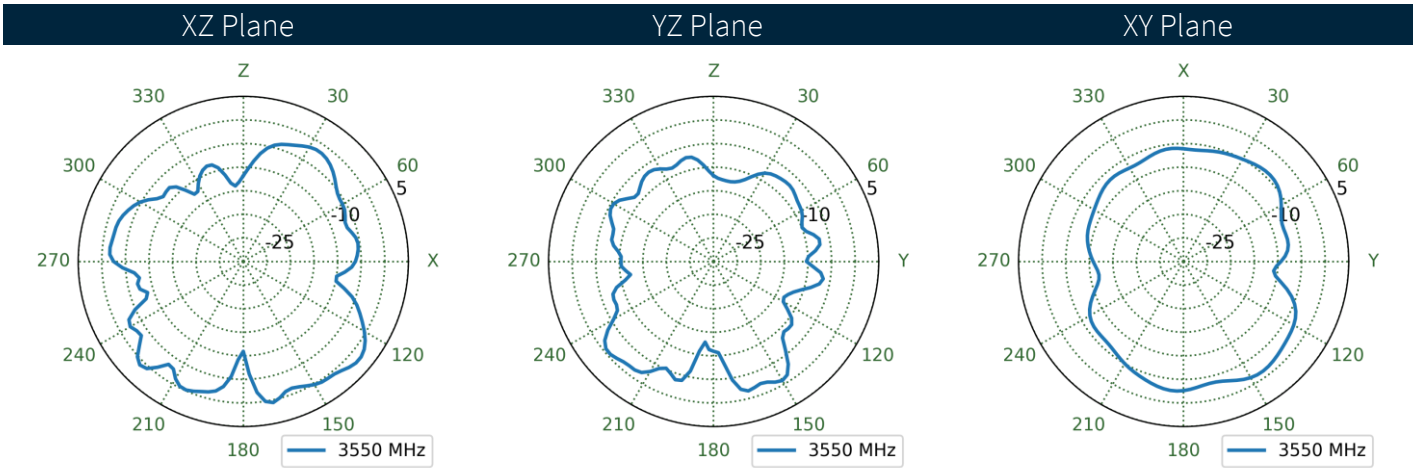
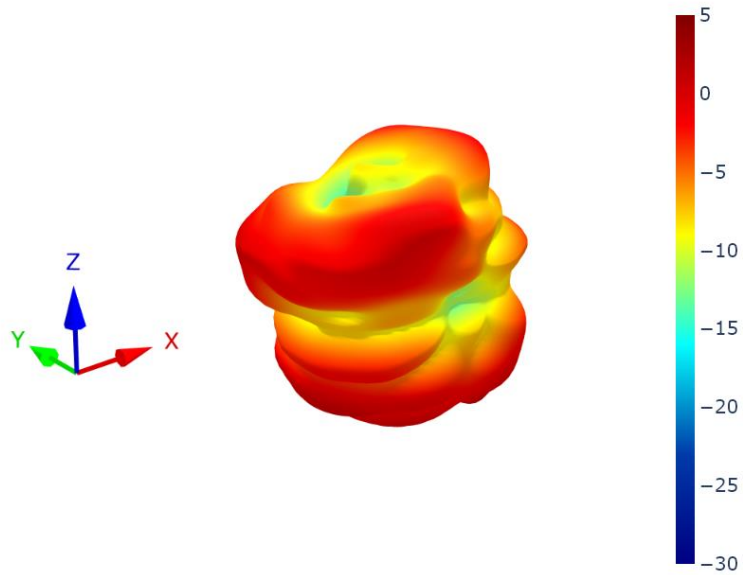

7.41 Straight Centre GroundPlane Patterns at 3550 MHz

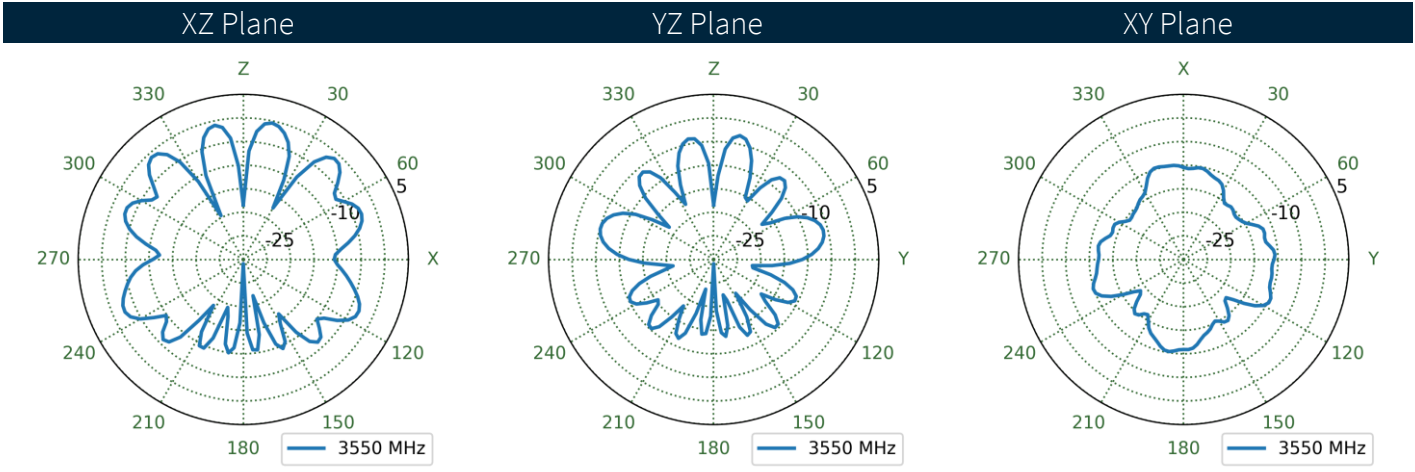
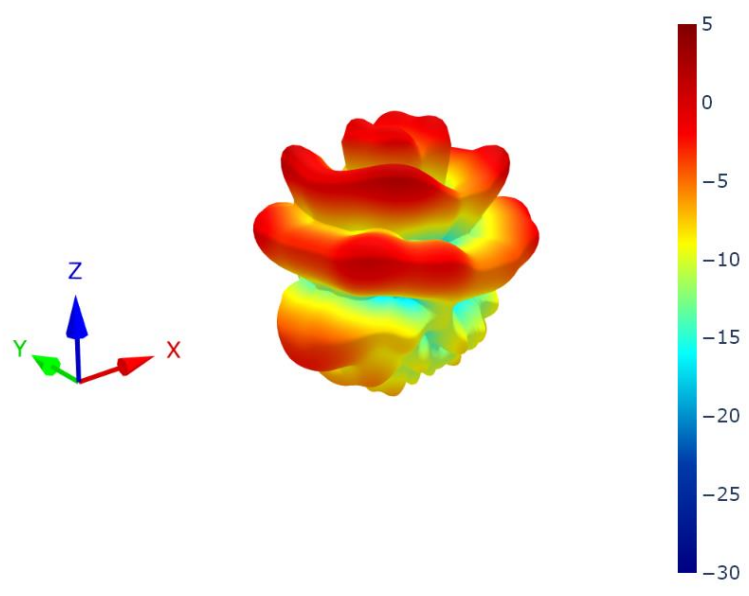

7.42 Straight Edge Ground Plane Patterns at 3550 MHz

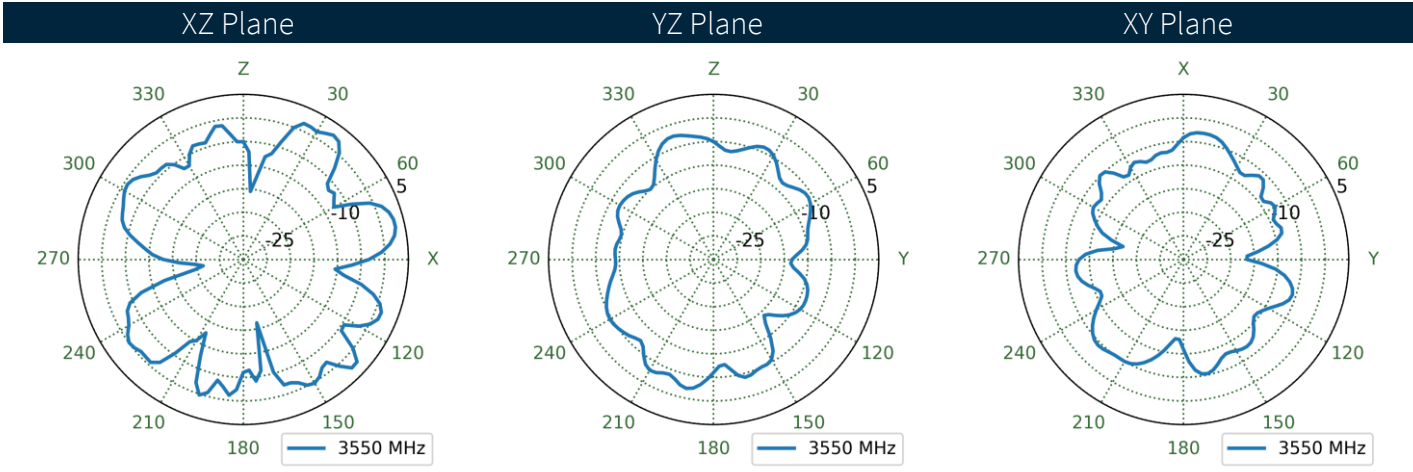
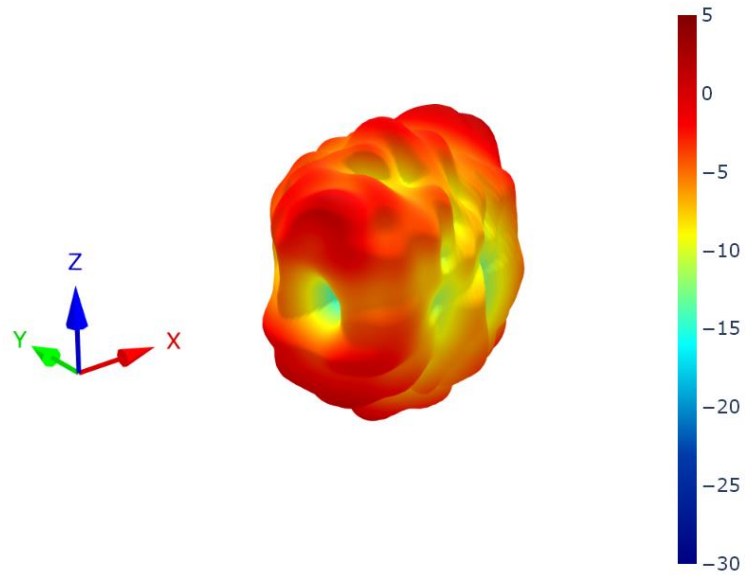

7.43 Straight Free Space Patterns at 3550 MHz

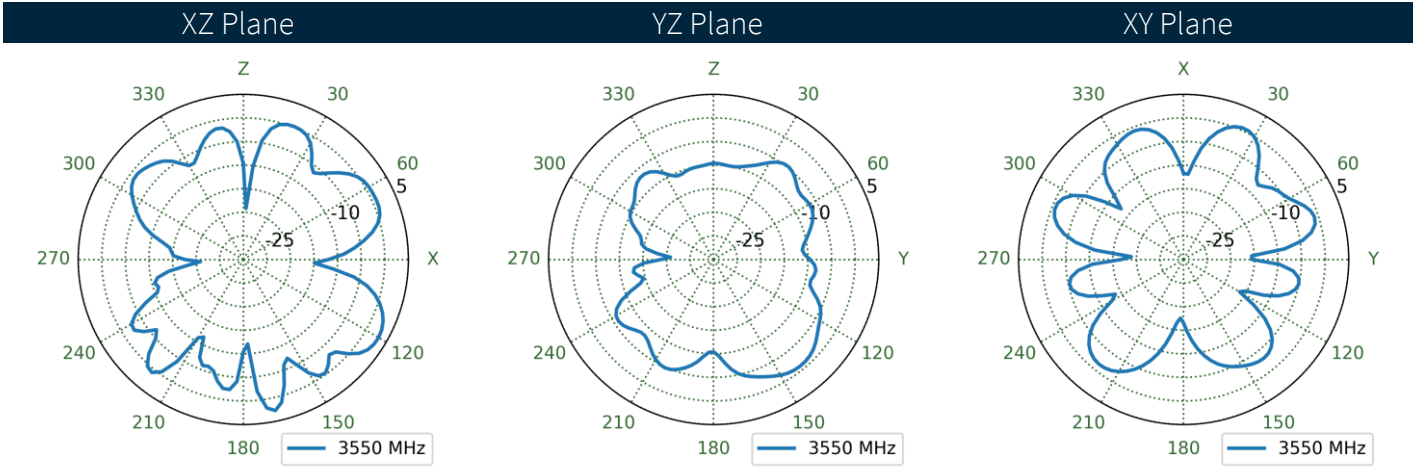
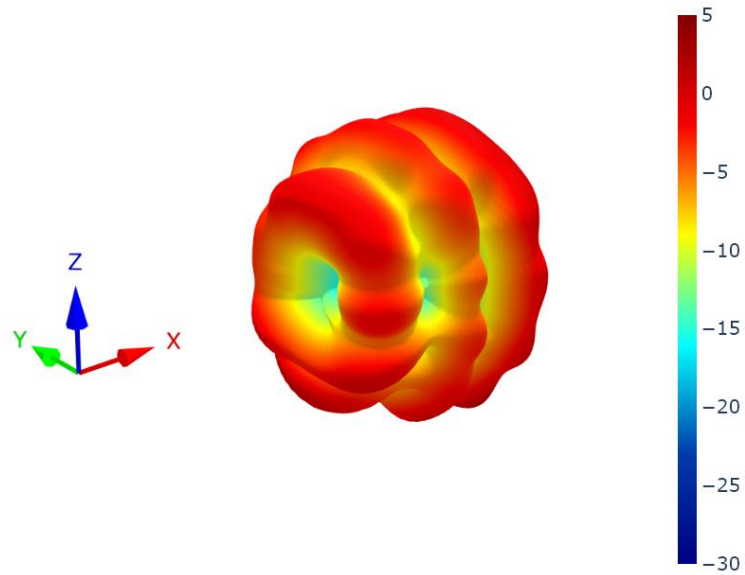

7.44 Bent Centre Ground Plane Patterns at 5550 MHz

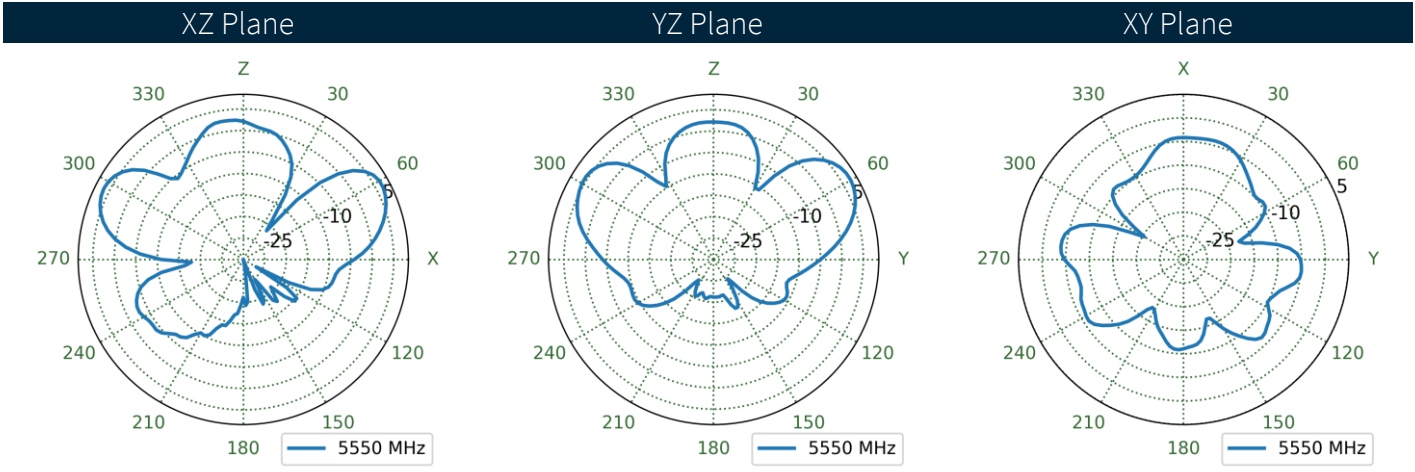
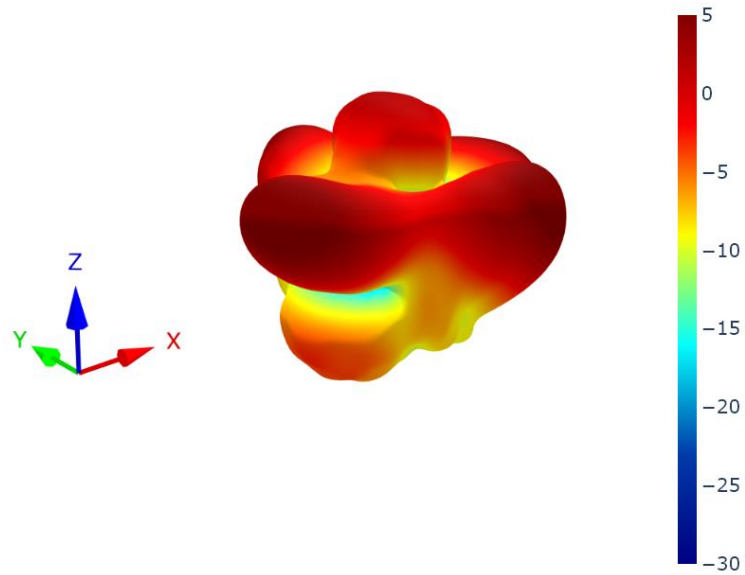

7.45 Bent Edge Ground Plane Patterns at 5550 MHz

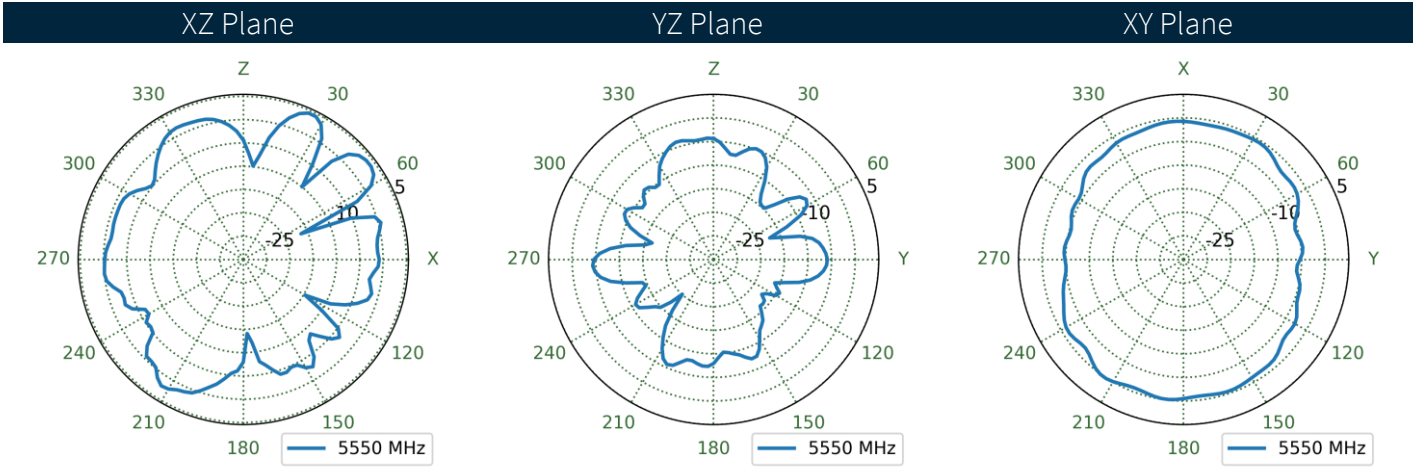
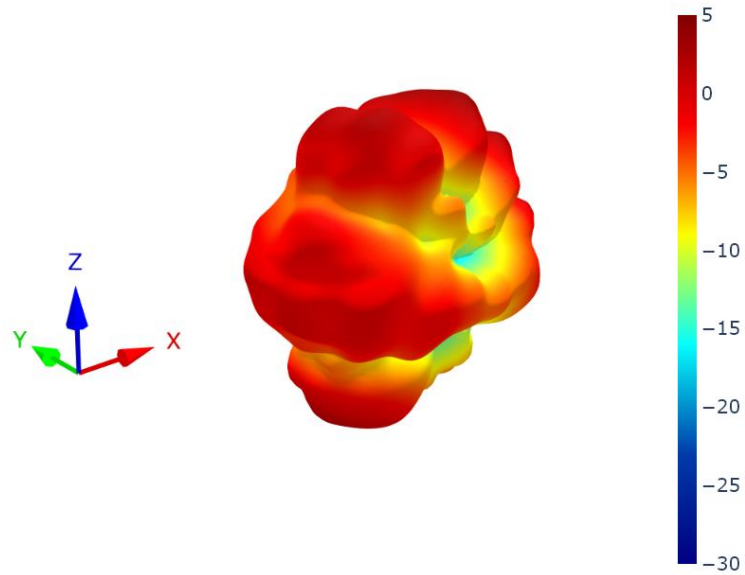

7.46 Bent Free Space Patterns at 5550 MHz

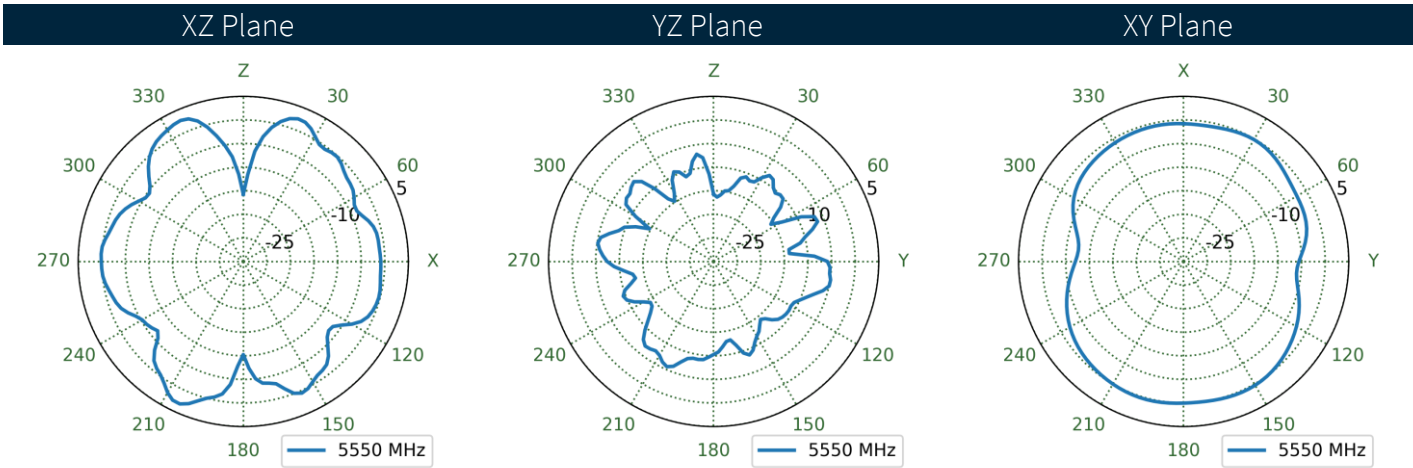
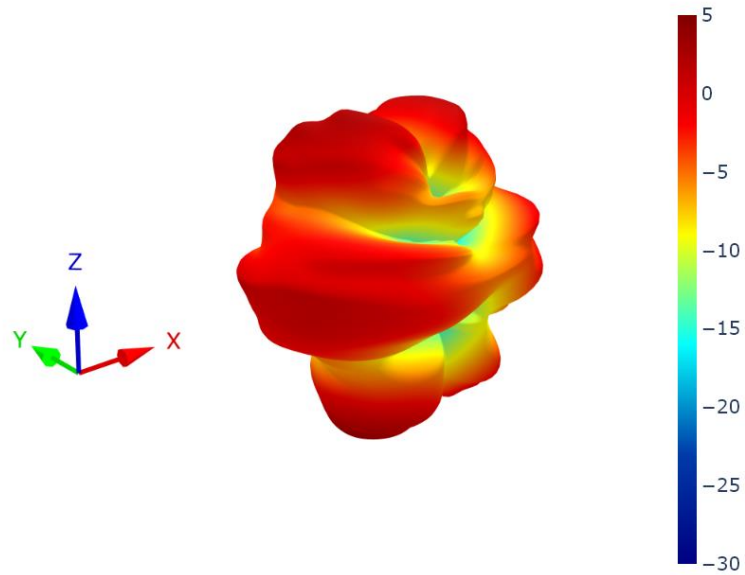

7.47 Straight Centre GroundPlane Patterns at 5550 MHz

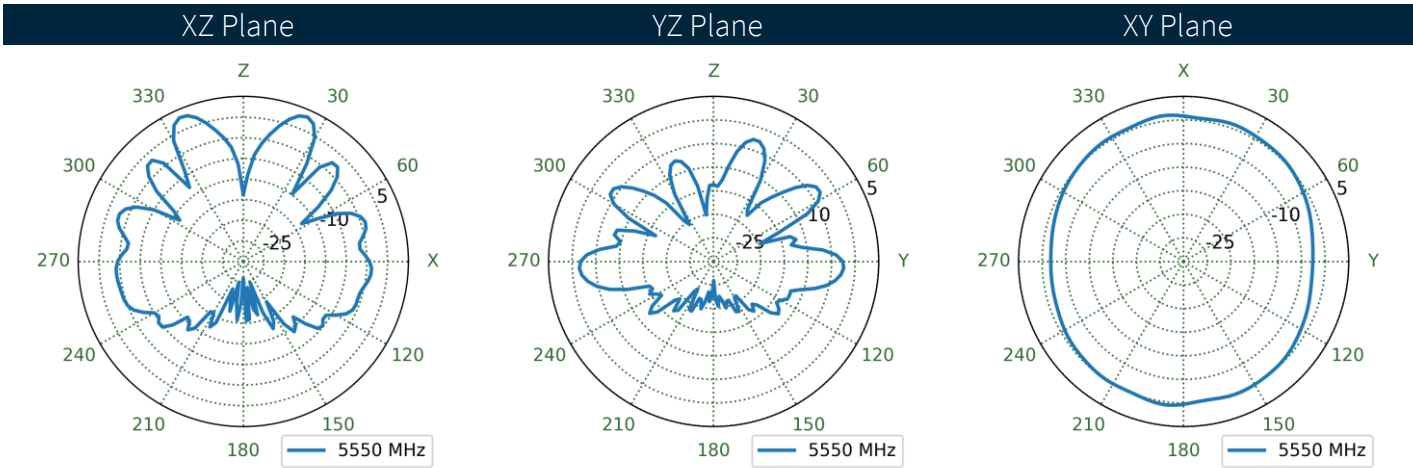
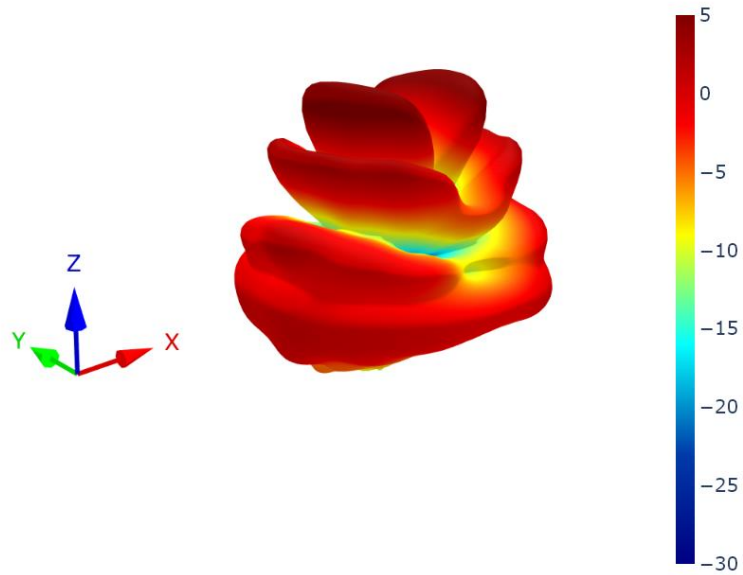

7.48 Straight Edge Ground Plane Patterns at 5550 MHz

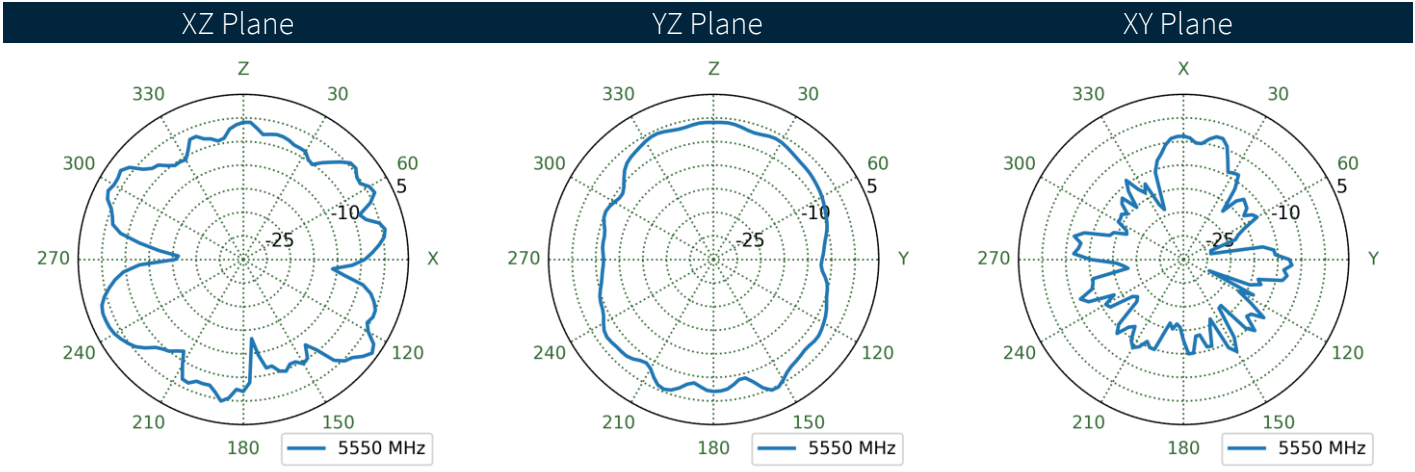
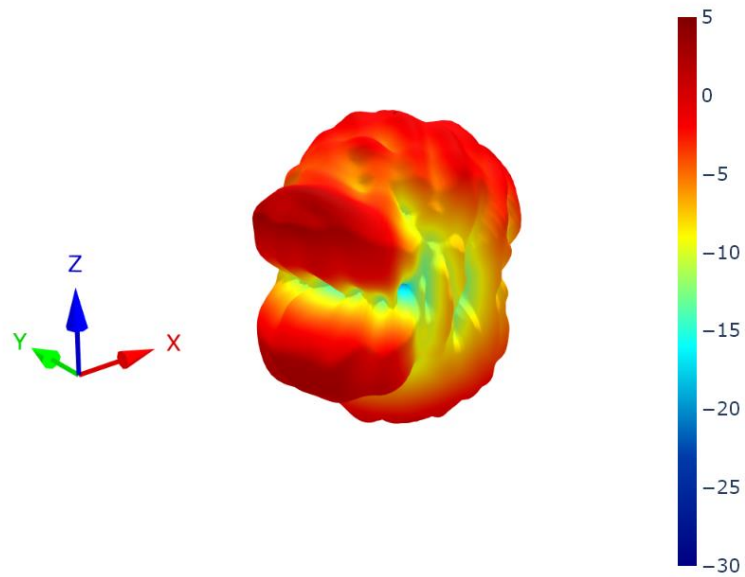

7.49 Straight Free Space Patterns at 5550 MHz

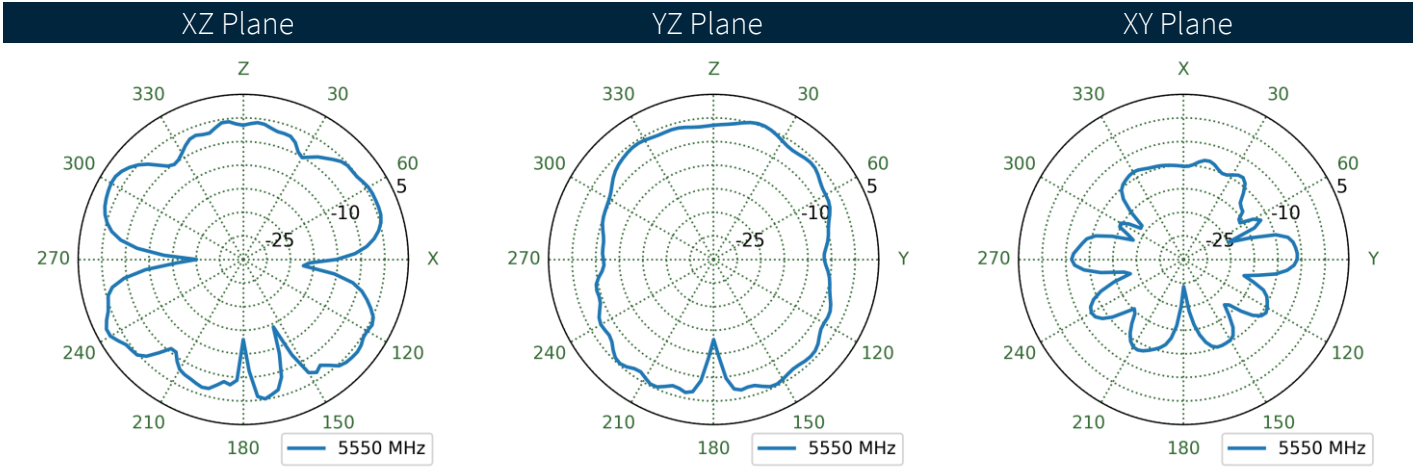
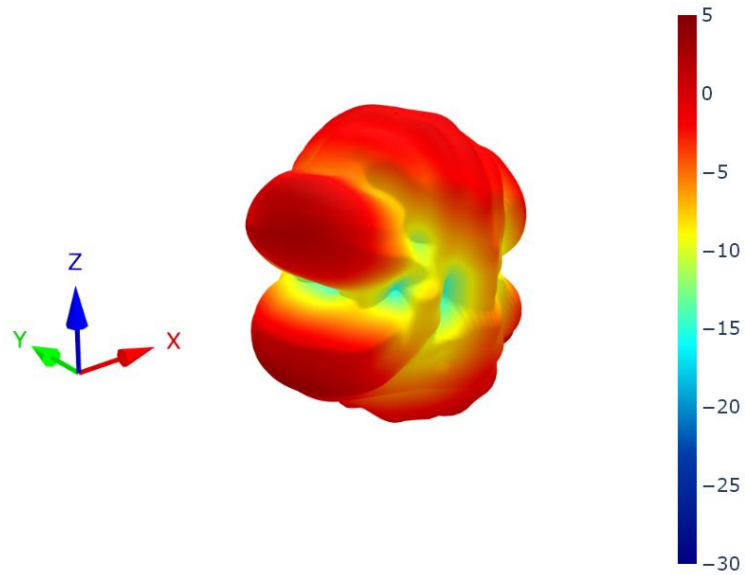

7.50 Bent Centre Ground Plane Patterns at 6525 MHz

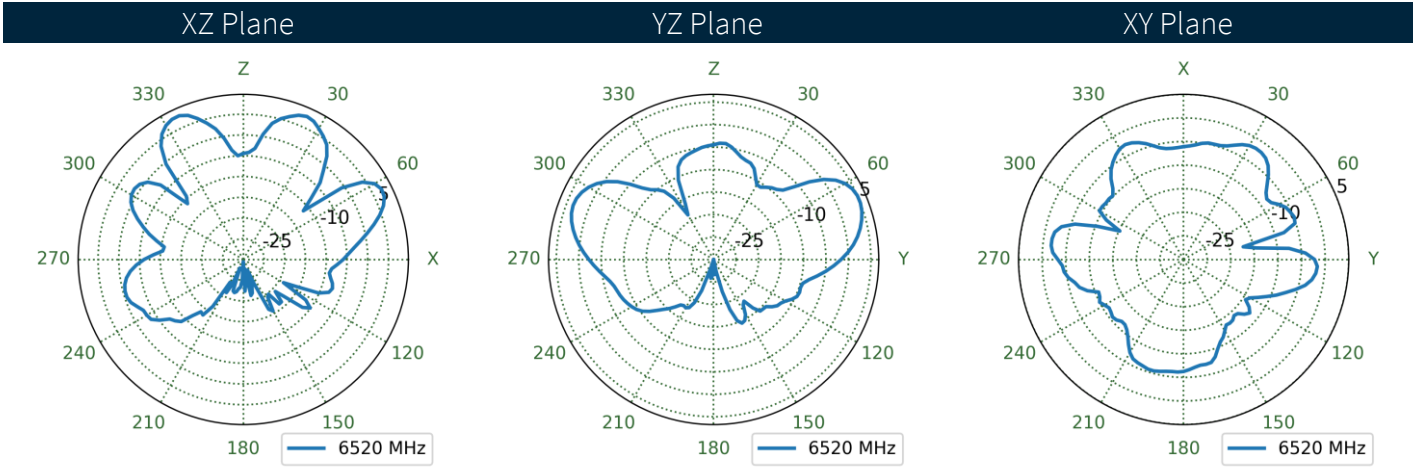
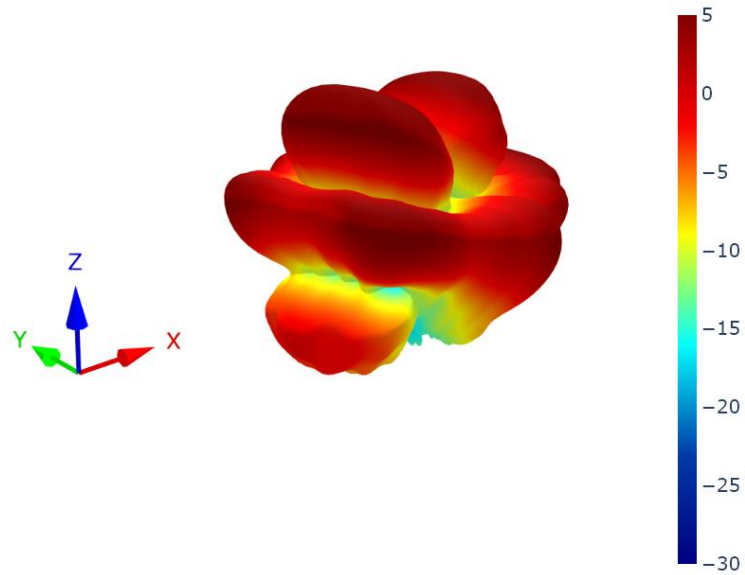

7.51 Bent Edge Ground Plane Patterns at 6525 MHz

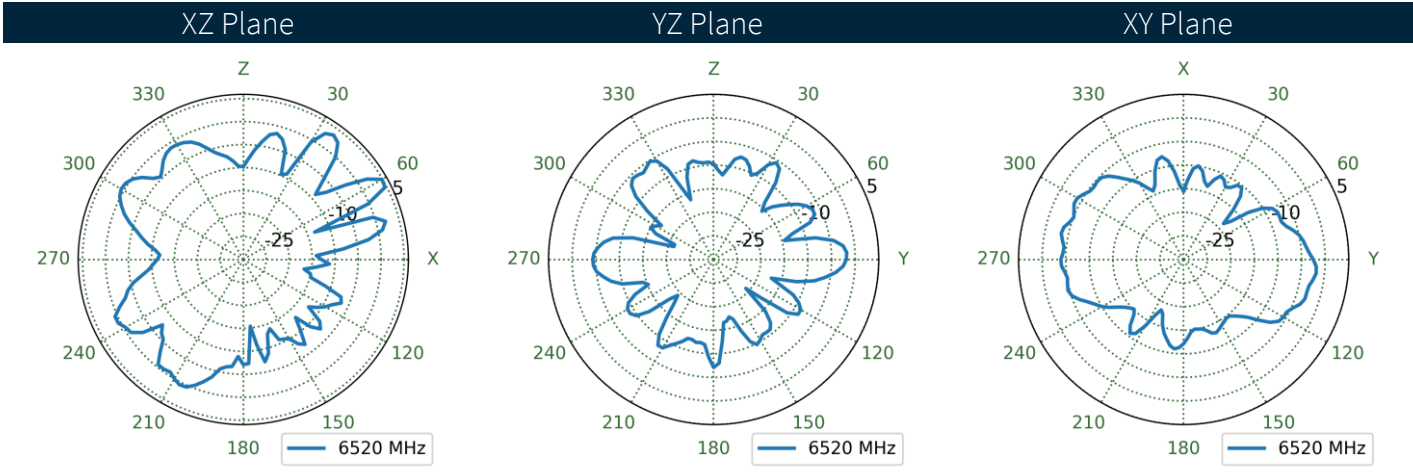
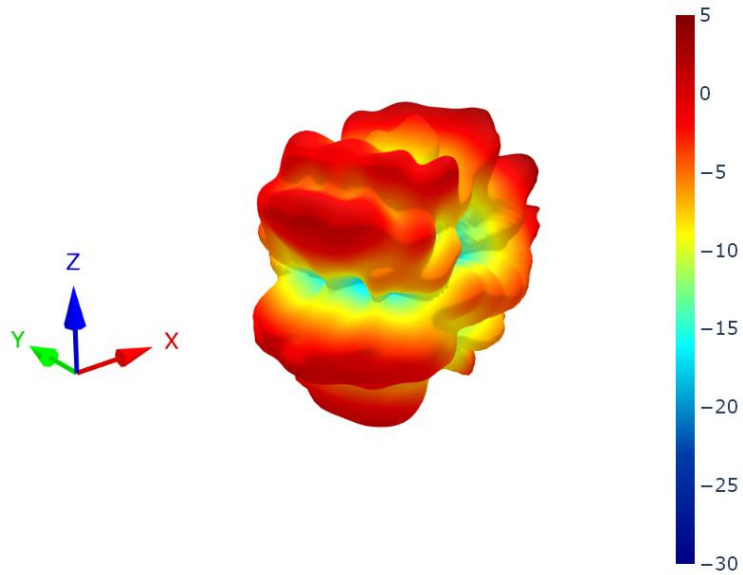

7.52 Bent Free Space Patterns at 6525 MHz

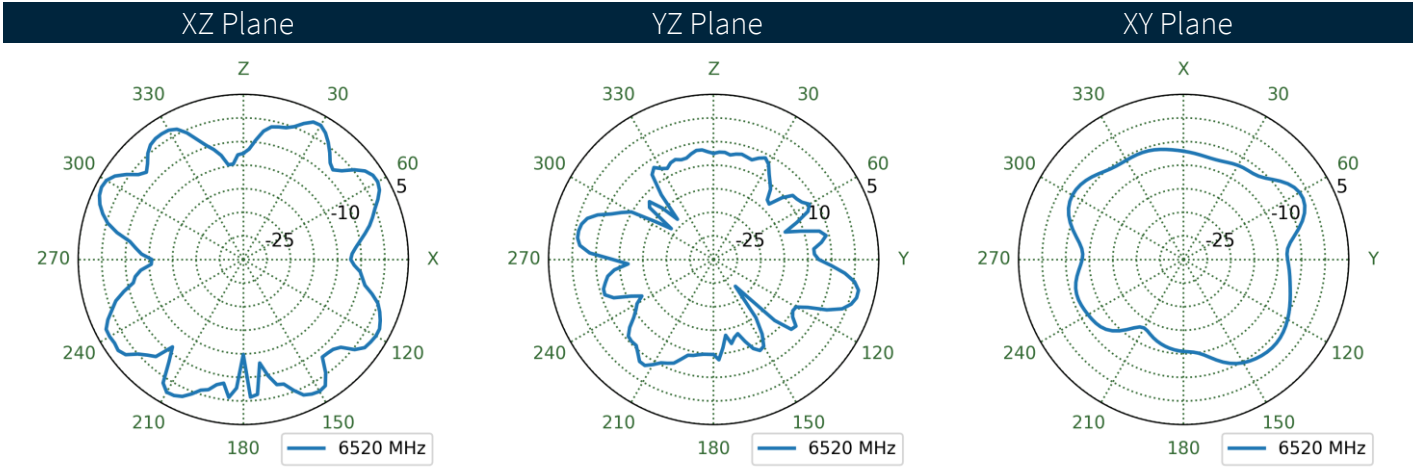
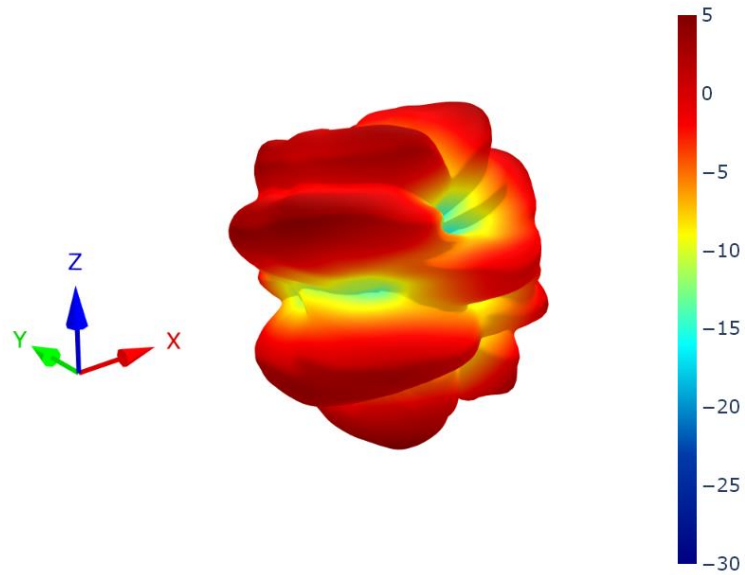

7.53 Straight Centre GroundPlane Patterns at 6525 MHz

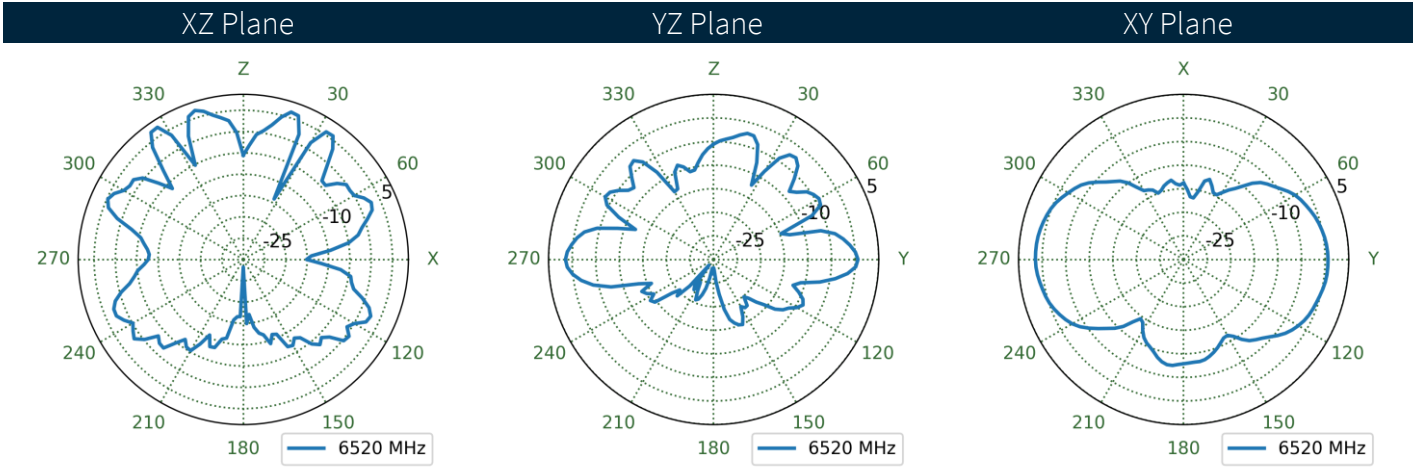
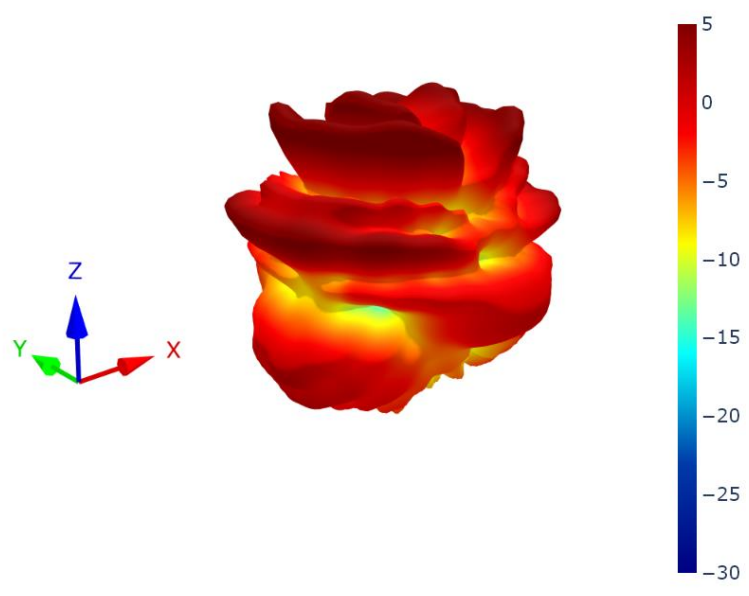

7.54 Straight Edge Ground Plane Patterns at 6525 MHz

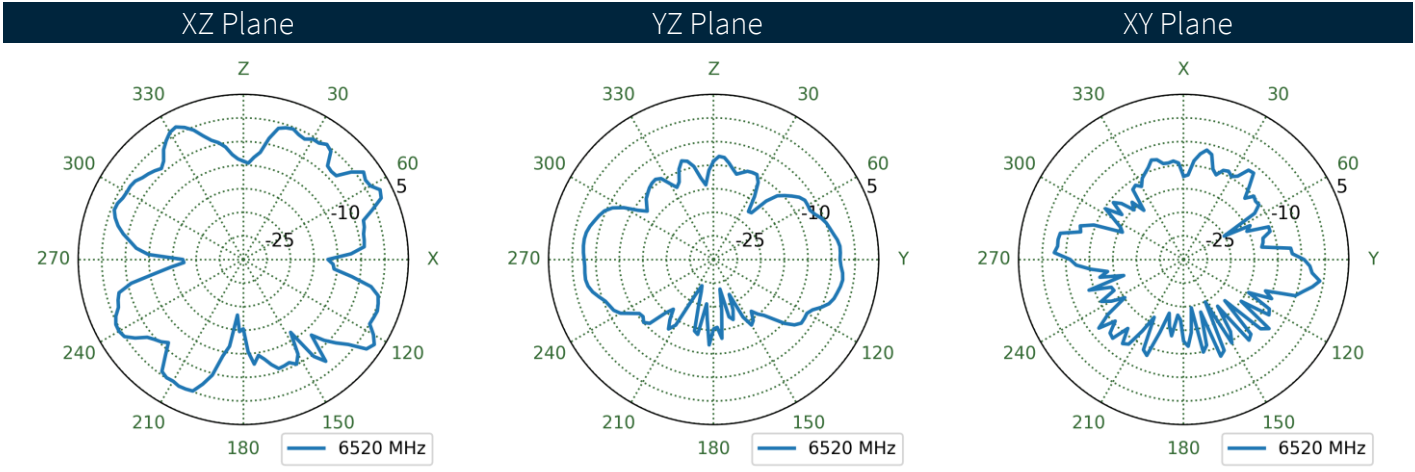
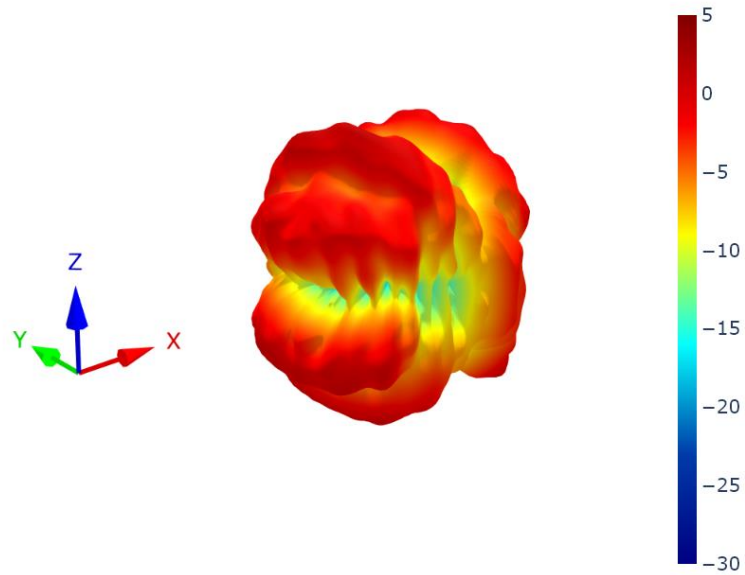

7.55 Straight Free Space Patterns at 6525 MHz

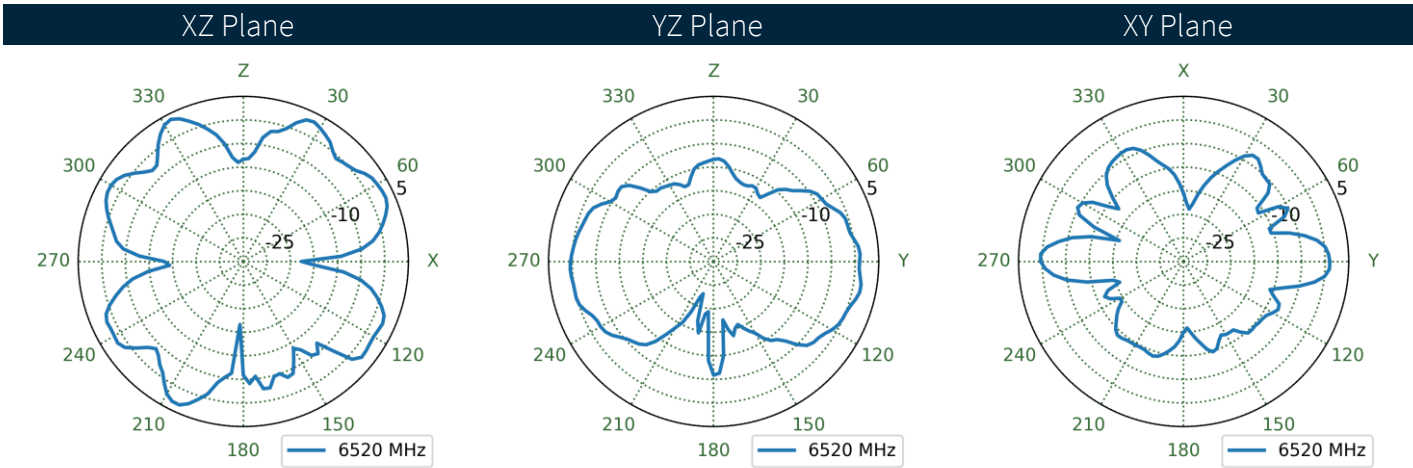
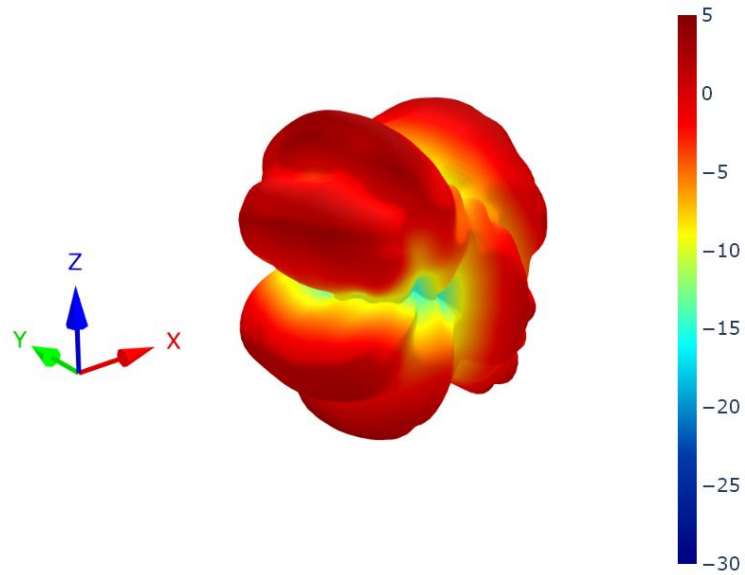

Changelog for the datasheet

SPE-12-8-125 - TG.30.8113W

Revision: N (Current Version)

Date:	2024-09-04
Changes:	Updated to include Wi-Fi 6 results.
Changes Made by:	Gary West

Previous Revisions

Revision: M

Date:	2023-11-15
Changes:	Updated 5G/4G Bands table
Changes Made by:	Cesar Sousa

Revision: H

Date:	2018-06-14
Changes:	Re-tested "Bent on Ground Planer Edge" configuration and results are much improved and consistent with the other three test configuration results.
Changes Made by:	Technical Writer

Revision: L

Date:	2023-01-16
Changes:	Adding band 40 to spec table (full datasheet update).
Changes Made by:	Gary West

Revision: G

Date:	2018-05-08
Changes:	Updated LTE band table - supports band 21
Changes Made by:	Technical Writer

Revision: K

Date:	2022-09-26
Changes:	Updated specifications
Changes Made by:	Cesar Sousa

Revision: F

Date:	2018-03-23
Changes:	Corrected flammability rating (UL-94 HB)
Changes Made by:	Technical Writer

Revision: J

Date:	2022-05-05
Changes:	Full datasheet template update and show data 600-6000.
Changes Made by:	Gary West

Revision: E

Date:	2018-03-13
Changes:	Adding flammability rating
Changes Made by:	Technical Writer

Revision: I

Date:	2018-08-14
Changes:	Change to IP Rating - Removed
Changes Made by:	David Connolly

Revision: D

Date:	2017-05-10
Changes:	D version appears in SVN on this date
Changes Made by:	Technical Writer

Previous Revisions

Revision: C		
Date:	2017-04-04	
Changes:	Updated Spec with LTE table	
Changes Made by:	Andy Mahoney	
Revision: B		
Date:	2017-01-13	
Changes:		
Changes Made by:	Technical Writer	
Revision: A (Original First Release)		
Date:	2012-10-02	
Notes:		
Author:	Technical Writer	



www.taoglas.com



Looking for pricing, stock, or lifecycle information?

Click below to explore more details on WIN SOURCE:

 [View TG.30.8113W on WIN SOURCE](#)

 [Taoglas Limited](#) Information

Optimize Your Supply Chain with WIN SOURCE Solutions

-  Global Sourcing Solution
-  Obsolete Management
-  Cost Control Management
-  Shortage Management
-  Alternative Solution
-  Excess Inventory Management