

1WA/1WD

Ellipse-shaped caps • different top surfaces • two sizes



DISTINCTIVE FEATURES

1WA : 6.5 x 12.5 mm

1WD - 8.0 x 15.2 mm

1WA/1WD : h=14.9 mm; convex top surface



SWITCH SPECIFICATIONS : see Multimec™ 3F series.

3F+1WA - SMD

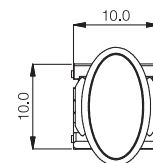
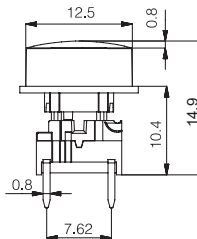
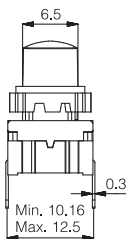

3F+1WD - TH W/LED

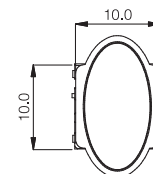
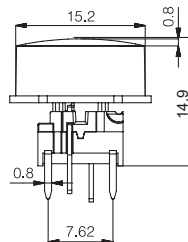
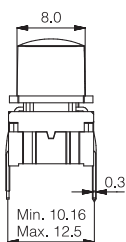

1WA/1WD

Ellipse-shaped caps • different top surfaces • two sizes

BUILD YOUR PART NUMBER

ILLUMINATED

3F

SERIES

MOUNTING

TH9 through-hole

LED

05	blue
20	green
40	yellow
65	white
80	red
2040	green/yellow
8020	red/green
8040	red/yellow

CAP

1WA

1WD

COLOR

16 frosted white

NON-ILLUMINATED

3F

SERIES

MOUNTING

TH9	through-hole
SH9	surface mount

CAP

1WA

1WD

COLOR

03	grey
09	black

NOTICE : Other versions : Please refer to www.apem.com for information on the 5G series versions - 1WAS/1WDS/1WPS



MOUNTING

- Panel cut-out :
1WA : min. 12.9 x 6.9 mm
1WD : min. 15.6 x 8.4 mm
- Switch spacing AxB :
1WA : min. 14.2 x 10.3 mm
1WD : min. 16.9 x 10.3 mm
- 8 mounting position options :



MATERIALS

- Cap :
- solid color : ABS UL94HB
- illuminated : polycarbonate UL94HB



STANDARD LEGENDS

STANDARD LEGENDS									
LEGEND	1D09_	1F096R_	1ZB09D_ 1ZB16DLMH_	1ZC_	1Z_ 1ZW_	10A_	10C_	10R_ & 10RF_ 10RM16_	10Q_ 10QM16_
0	000	000							
1	001	001							
2	002	002							
3	003	003							
4	004	004							
5	005	005							
6	006	006							
7	007	007							
8	008	008							
9	009	009							
#	107	107							
*	019	019							
←	033								
→	133								
↑	034								
↓	134								
↙	135	135							
+						054		054	054
-						059		059	059
▲			136		136	136			
⏻	123	123		123*	123		123	123	123
ON/OFF								017	017
STOP								018	018
START								031	031
RESET				038				038	038
CANCEL								048	048
ENTER								105	105
ESC				051					
ON						116			
OFF						117			
OK				118*	118		118	118	118
SET				119					
MENU				120					
FUNC				121					
HOME				122					

STANDARD OPTIONS

- 1D: pad printed
- 1F: reverse printed
- 1ZB: pad printed / laser marked
- 1ZC: pad printed *reverse printed *laser marked
- 1Z & 1ZW: pad printed / laser marked

- 10A: pad printed / laser marked
- 10C: pad printed / laser marked
- 10R(F) & 10Q: pad printed / reverse printed
- 10RM & 10QM: metal symbol

Legends

Available for Multimec caps



HOW TO ORDER

POSITIONING OF LEGENDS ON ROCKER-ACTION CAPS

When ordering legends for caps with hinge-type cap retention system, it is important to note the position of the cap. An extra letter (U, D, R or L) needs to be added to the part number to refer to the position of the hinges in relation to the legend. See samples:

Rocker-action caps without a lens: 1A, 1B, 1M, 1ZA and 1ZB

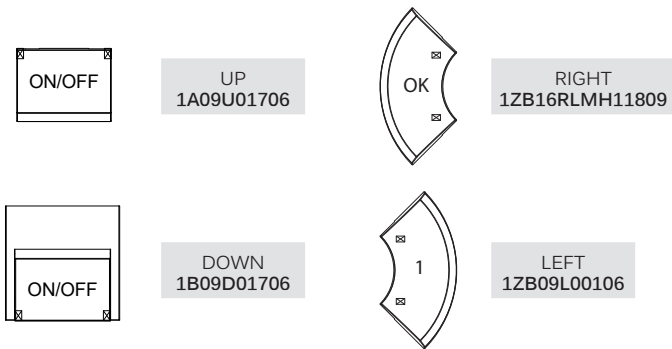

STANDARD AND CUSTOM LEGENDS

- Standard are only certain legends on certain caps. See the table on the previous page.
- All standard pad-printed legends are white on black caps.
- All standard reverse-printed and laser marked legends are black on frosted white cap.

STANDARD LEGENDS

CAP	CAP COLOR	DIRECTION*	TYPE*	LEGEND	LEGEND COLOR*
1D	00 Blue	D Down	UV UV printed	001 1	00 Blue
1F	02 Green	U Up	LM Laser marked on soft paint	002 2	03 Grey
...	03 Grey	R Right	LMH Laser marked on hard paint	003 3	06 White
	04 Yellow	L Left	R Reverse printed	...	08 Red
	06 White	*Only for hinge-type caps			09 Black
	08 Red		*In case of illumination		MC Multi color
	09 Black				... Etc
	16 Frosted white				
	... Etc				

*In case of reverse printed and laser marked legends the colour of the paint

LEGEND ILLUMINATION

- **Option 1 - laser marked:** In case of laser marked legends an "LM" is added after the cap colour, before the legend code. We recommend using hard paint (additional "H") for increased lifetime of the paint. E.g. 1ZB16DLMH13609
- **Option 2 - reverse printed:** In case of reverse printed caps an "R" is added after the cap colour, before the legend code. Especially relevant when standard legends have both negative and positive print options. E.g. 1F096R00009
- **Option 3 - metal symbol:** Only available for 10RM and 10QM (therefore the "M"). E.g. 10RM16059

ORIENTATION OF THE SWITCH

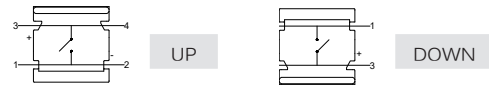





















Notice: The size of the legends listed may not correspond to the actual size.

If you decide to use one of the standard legends without any adjustments (without a new cliché or programming) on another cap than designated in the table, then there is no cliché or programming cost, for this to apply the cap has to be black and the print white.

For further information on legends please contact APEM.

Solid colors

Available for Multimec caps

Colour / RAL Code		Blue / 5012	green / 6018	Grey / 7004	Yellow / 1023	White / 9010	Red / 3000	Black / 9004	Ultra blue / 5002	Mint green / 6029	Teal grey / 7046	Melon / 1028	Signal white / 9003	Noble red / 3002	Dusty blue / 5014	Aqua blue / 5021	Metal dark blue / No ral code	Metal light grey / No ral code	Metal dark grey / No ral code	Metal bordeaux / No ral code	
CAP	CODE	00	02	03	04	06	08	09	30	32	33	34	36	38	40	42	50	53	57	58	
1A		•	•	•	•	•	•	•													
1B		•	•	•	•	•	•	•													
1D		•	•	•	•	•	•	•	•	•	•	•		•	•	•	•	•	•	•	•
1E/1F				•				•													
1GA/1GC								•													
1H				•				•													
1K		•	•	•	•	•	•	•													
1M			•	•			•	•													
1N				•				•													
1P		•	•	•	•	•	•	•													
1Q		•		•				•													
1R				•																	
1S		•	•	•	•	•	•	•													
1T/1U/1V		•		•			•	•													
1WA/1WD				•				•													
1X				•		•		•													
1ZA				•		•		•	•						•	•	•	•	•	•	•
1ZB				•		•		•	•						•	•	•	•	•	•	•
1ZC				•		•	•	•	•						•	•	•	•	•	•	•
10A				•			•	•													
AQC								•													

The RAL Codes mentioned are the codes nearest to the solid colors in the multimec™ range.

*3E actuators and Varimec use different materials and therefore have a different color code and are not represented in this table

Cap & Bezel Specifications

Multimec™ caps

ACCESSORY SPECIFICATIONS			
MATERIAL	PARTS	TEMP. LIMIT	UL RATING
ABS	Solid color 1A, 1B, 1D, 1E, 1F, 1H, 1K, 1M, 1N, 1P, 1Q, 1R, 1T, 1U, 1V, 1WA, 1WD, 1X, 1ZA, 1ZB, 1ZC and AQC Bezels 2C, 2D and 2K, reflectors for 1KB, 1KC, 1Y and 1YA	Max 65 °C Max 149 °F	UL94HB
Polycarbonate	All lenses and transparent colour caps, lids for 1KB & 1KC	Max 85 °C Max 185 °F	UL94HB
Polyamide	1GA, 1GC, 1S and 2S	Max 160 °C Max 320 °F	UL94V2
Legends adhesion	DS/EN ISO 2409 Class 1 & ASTM D3359 Class 4B		

Multimec™ 3F

High performance tactile switches •
robust



DISTINCTIVE FEATURES

10 x 10 mm; h=10.4 mm

Illuminated RAS option

Slip-on cap retention system - great for custom caps



ENVIRONMENTAL SPECIFICATIONS

- Sealing : IP67 according to IEC 60529
- Working and storage temperature :
 - non-illuminated : -40 °C/+160 °C (-40 °F to +320 °F)
 - illuminated : -40 °C /+85 °C (-40 °F to +185 °F)
- Soldering :
 - through-hole : IEC 60068-2-20 8
 - surface mount : JEDEC J-STD-020E



ELECTRICAL SPECIFICATIONS

- Recommended load :
 - Gold contacts : 0.5µ-50 mA 24 VDC
 - Silver contacts : 0.5-50 mA 24 VDC
- Contact resistance : <30 mΩ - typically 10 mΩ
- Insulation resistance : >10 MΩ
- Contact bounce : <2 mS - typically 0.5 mS



MECHANICAL SPECIFICATIONS

- Standard actuation force : 3.5 N
- Max. actuation force : 100 N for 10 sec
- Travel : 1 mm
- Lifetime : >10,000,000 cycles

The company reserves the right to change specifications without notice.

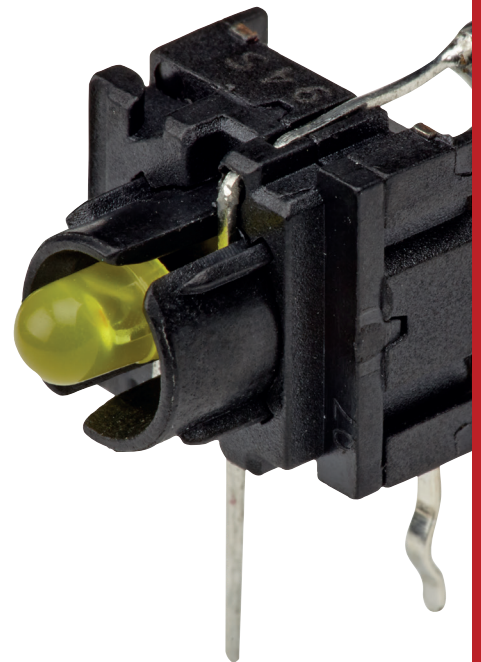

MATERIALS

- Housing : PPS UL94V0
- Actuator : PPS UL94V0
- Sealing : Silicone rubber
- Contacts spring : Stainless steel
 - Silver : +3 µAg
 - Gold : +1 µAu
- Fixed contacts :
 - Silver : SnCu + 2 µNI + 3 µAg
 - Gold : SnCu + 2 µNI + 1 µAu
- Terminals : SnCu + 2 µNI + 3 µSn100

All tolerance if not otherwise specified ±0.2 mm.

Multimec™ 3F

High performance tactile switches • robust

3F - SMD

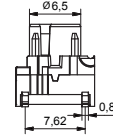
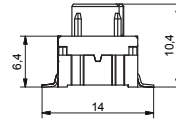
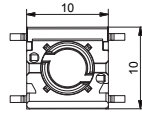

3F - TH

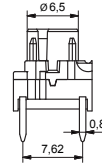
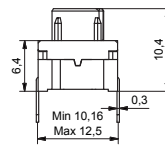
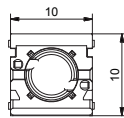

3F - TH W/LED

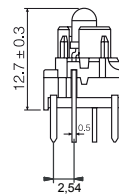
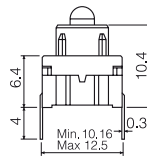
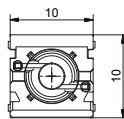

3F - RAS

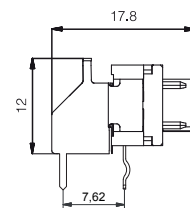
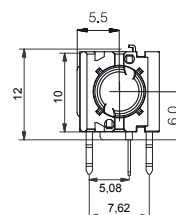
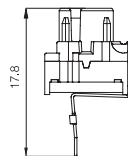

High performance tactile switches • robust

3F - RAS W/LED

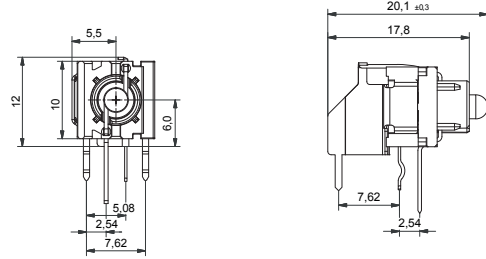
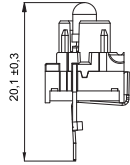

PCB LAYOUT & CIRCUIT DIAGRAM

TH Non-ill.

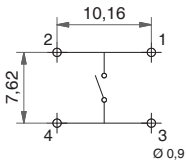

SMD non-ill.

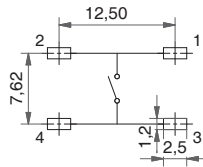

TH illuminated

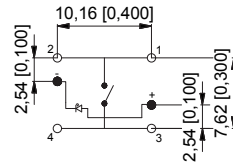

TH bi-color illuminated

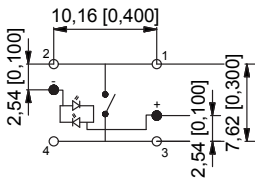

RAS

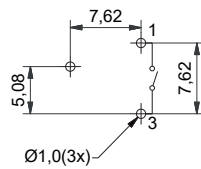

RAS illuminated

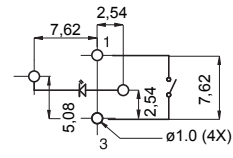

RAS bi-color illuminated

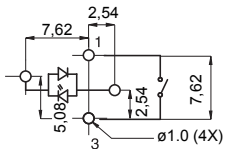

Multimec™ 3F

High performance tactile switches • robust

BUILD YOUR PART NUMBER

ILLUMINATED

3F

SERIES

MOUNTING

TH9	through-hole
------------	--------------

LED

06	blue
20	green
40	yellow
65	white
80	red
2040	green/yellow
8020	red/green
8040	red/yellow
24	high intensity green
46	high intensity yellow
87	high intensity red

OPTIONAL

Q	quiet contact
G	gold contacts
RAS	right angle

NON-ILLUMINATED

3F

SERIES

MOUNTING

TH9	through-hole
SH9	surface mount

OPTIONAL

Q	quiet contact
RAS	right angle (with TH only)
R	tape & reel (with SMD only)
G	gold contacts

ABOUT THIS SERIES

 Caps and accessories : for the full range of accessories for Multimec™ 3F please see the website.



TAPE & REEL

Tape and reel is available for the parts listed and has the following specifications

- Reel diameter: Ø330 mm
- Tape width: 24 mm
- Pitch: see list
- Tape and reel material: antistatic or better
- Quantity per reel: see list

PART NO.	ORDERING CODE	PITCH	QUANTITY PER REEL
3FSH9	3FSH9R	20	250



OPERATING FORCE

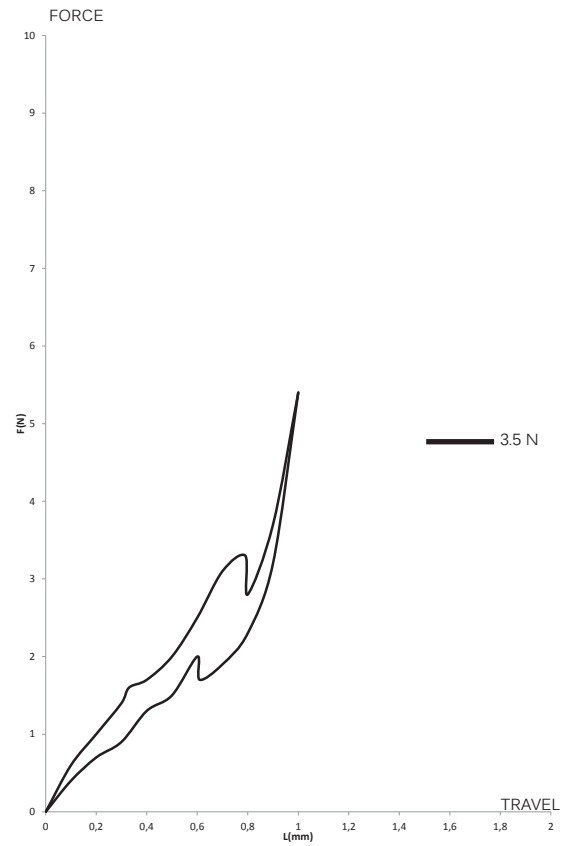

MOUNTING

MOUNTING TOOLS FOR MULTIMEC™ THROUGH-HOLE SWITCHES

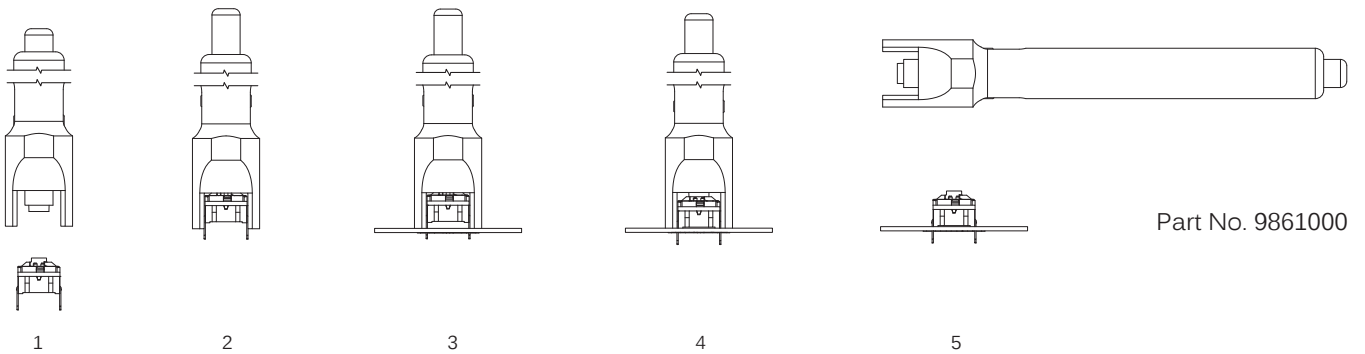

Multimec™ 3F

High performance tactile switches •
robust



MOUNTING (CONTINUED)

SPACE REQUIREMENT - MATRIX MOUNTING

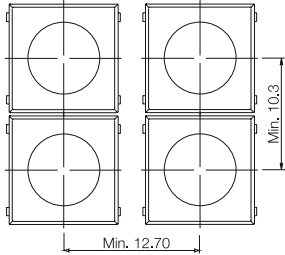

Through-hole (TH)

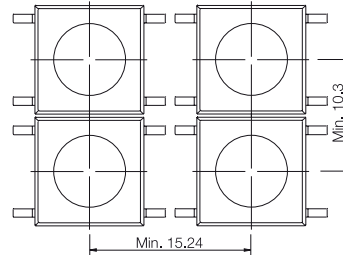

Surface mount (SMD)

MULTIMEC™ SPACING EXAMPLES

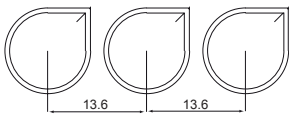

1N+1N+1N

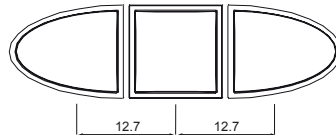

1V+1T+1V

SPACE REQUIREMENT - SWITCH/CAP

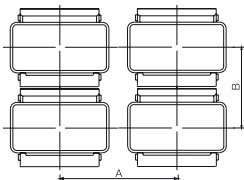

Switch spacing

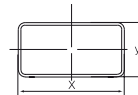

Cap dimensions

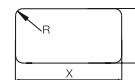

Panel cut-out

CAP SERIES	RECOMMENDED MIN. SWITCH SPACING AxB	NOMINAL CAP DIMENSION WxH	RECOMMENDED MIN. PANEL CUT-CUT
1D/1E/1F	12.7x11.3	Ø9.6	Ø10.0
1GA	12.7x11.3	Ø11.0	Ø11.4
1GC	15.3x15.3	Ø15.0	Ø15.4
1K/1KB/1KC	14.6x14.6	14.3x14.3	14.7x14.7
1N	13.6x11.3	Ø9.8/ □4.9	Ø10.2/□5.1
1P/ 1Q/1R	12.8x10.3	6.5x12.5	7.0x13.0, R max. 1.0
1S	12.7x10.3	Ø6.5	Ø7.0
1T	12.7x12.3	10.6x10.6	11.0x11.0
1U	12.7x12.3	Ø10.6	Ø11.0
1V	15.95x12.1	10.6x13.25	11.0x13.65
1WA	14.2x10.3	12.5x6.5	12.9x6.9
1WD	16.9x10.3	15.2x8.0	15.6x8.4
1X	12.7x10.3	9.4x7.4	9.8x7.9
1ZC	14.6x14.6	Ø14.3	Ø14.7



LED COMPONENT SPECIFICATIONS

LED COMPONENT SPECIFICATIONS												
Color		B	G	Y	W	R	G/Y	R/G	R/Y	G	Y	R
Color Codes		06	20	40	65	80	2040	8020	8040	24	46	87
ABSOLUTE MAXIMUM RATINGS (Ta=25°C)												
Power	mW	120	120	60	110	100	100/60	100/100	75/75	60	60	60
Current forward	mA	30	30	20	30	30	30/20	30/30	30/30	25	25	25
Forward peak current	mA	150	90**	80**	100	90**	120/80	120/120	160/140	60	60	60
Voltage reverse	V	5	3	5	5	3	5	5	5	5	5	5
Operating temperature	°C	-40/+85	-55/+100		-40/+85	-55/+100	-55/+100	-55/+100	-40/+85	-40/+85	-40/+85	-40/+85
Storage temperature	°C	-40/+85	-55/+100		-40/+100	-55/+100	-55/+100	-55/+100	-40/+85	-40/+100	-40/+100	-40/+100
Soldering temperature	°C	260 for max 3 sec					260 for max 2 sec			260 for max 5 sec		
ELECTRICAL-OPTICAL CHARACTERISTICS (Ta=25°C)												
Voltage forward	Typ. V	3.3	2.1	2.1	3.0	2.0	2.1/2.1	2.0/2.1	2/2.1	2.0*	2.0	2.0***
	Max. V	4.0	2.6	2.6	4.0	2.6	2.6/2.4	2.6/2.6	2.5/2.5	2.4*	2.4	2.4***
Current reverse (VR=5V)	µA	Max. 50	100	100	100	100	100	100	2	10	10	10
Wave length	nm	460	569	588	NA	625	565	621/569	617/588	573	589	624
Spread	Δnm	25	40	35	NA	40	30/35	40/30	45/35	20	NA	20
Spread angle	degree	30	60	60	25	60	80/60	200	60	100	40	40
Luminous Intensity	Min. mcd	900	5.6	1.7	715	2.5	3.7/2.5	2.2/2.2	6/4	10	630	400
	Typ. mcd	1600	12.6	5.6	max 2850	8.7	12.6/8.7	4.8/4.8	14/8	20	1250	800
Orientation	The longer pin is the anode, the shorter is the cathode. For bi-color LEDs the anode for the first color (ex. 8020) is the longer pin.											

*/F=20mA, **1/10 duty cycles 0.1ms pulse width, ***/F=50mA, ****Luminous Flux mlm

Multimec™ 3F

High performance tactile switches •
robust



USAGE GUIDELINES

HOW TO GET THE BEST RESULTS WITH MEC SWITCHES ?

These guidelines are offered to users of MEC Switches as an aid to ensure successful and reliable switch operation. Please see the technical specifications for details on operating and storage temperatures and soldering guidelines to make sure you select the best switch for your application. When reflow soldering is taking place, MEC strongly recommend that the temperature profile is analyzed and compared with the temperature rating of the switch. It is also important to monitor the accumulated heat buildup from both the pre-heat zones and the solder zone.

Most standard accessories for multimec™ 3 series switches are made from ABS plastic with a maximum operating temperature of 65 °C. It is strongly recommended that accessories are mounted after soldering of the switch. If this is not possible care must be taken not to overheat the accessories during the soldering process. The 1S and 1GA/1GC caps are, however, made of high temperature materials and will meet the same temperature specifications as the switches. For accessories made from other plastic materials please see multimec™ 3 cap & bezel technical specifications.

LEDs have their own temperature specifications. When fitted in a 3F switch the LED will determine the max. operating temperature, i.e. 3FTH924 has an upper temperature limit of 85 °C!

MOUNTING AND DISMOUNTING

If switches are to be mounted in rows it is essential that the recommendations regarding spacing are followed. PC board thickness should be 1.4 ±0.2 mm and terminal hole diameter should be 0.9 mm.

All multimec™ caps and bezels are easily slid onto the switch modules and can be changed at a later time .

Care must be taken when inserting the 3FT switch and LED assembly into the PC board. Do not press direct on the LED. This will force the LED down into the actuator and risks to cause the switch contacts to remain in the closed position. To correct the fault, the LED must be raised slightly and centered in the actuator to assure unrestricted movement of the actuator.

A mounting tool is available for through hole multimec™ 3 series switches.

SOLDERING AND CLEANING MULTIMEC™ 3 SERIES

Multimec™ 3 series switches are fully sealed to IP67 specifications to prevent solder flux and aqueous based cleaning solutions from entering the switch and contaminating the contacts. The switches can be placed on the PC board with other components and reflow soldered. Multimec™ 3 series

offers a high level of sealing, however, with aqueous solvent solutions care must be taken to avoid the worst case situation with water jets, complete immersion into a liquid with a temperature below the board or surface tension reducing additives.

Recommended cleaning methods are demineralized water. Any surface tension reducing agents, such as soap, must not be used as they risk causing a potential leakage of the switch.

SOLDERING - THROUGH HOLE VERSIONS

Hand soldering: max. 350 °C for max. 3 sec

Wave soldering: heat built up in the switch during pre-heating and soldering must not exceed the maximum operating temperature of the switch. Peak temperature must not exceed 260 °C, and soldering time is max 10 sec. (IEC 60068-2-20 8)

SOLDERING - SURFACE MOUNT VERSIONS

For all methods - infrared, convection and vapor phase. The upper limit 240 °C/40 sec must be observed. The soldering temperature profile must have moderate temperature gradients. (JEDEC J-STD-020E)

ROHS COMPLIANCE

As of 1 July 2006 MEC has completed the conversion to RoHS compliance. For more info please see our homepage www.apem.com

TEMPERATURE LIMITS

Switch	160 °C
LEDs	80/85/100 °C
Accessories	65/85/160 °C

PACKAGING

Multimec™ 3 series switches are packed in rigid tubes of 50 pieces each.

A box contains 1.000 pcs.

The surface mount versions of multimec™ 3 series switches with a height up to 12.5 mm can also be delivered on tape/reel.

Each reel contains 250/500 pcs.

Right angle switches are packed in trays.
A tray contains 100 pcs.

Looking for pricing, stock, or lifecycle information?

Click below to explore more details on WIN SOURCE:

 [View 1WA03](#) on WIN SOURCE

 [MEC Switches](#) Information

Optimize Your Supply Chain with WIN SOURCE Solutions

-  Global Sourcing Solution
-  Obsolete Management
-  Cost Control Management
-  Shortage Management
-  Alternative Solution
-  Excess Inventory Management