

2M-Series

Miniature Toggles Switches

PRODUCT WEBPAGE

request sample, configure part

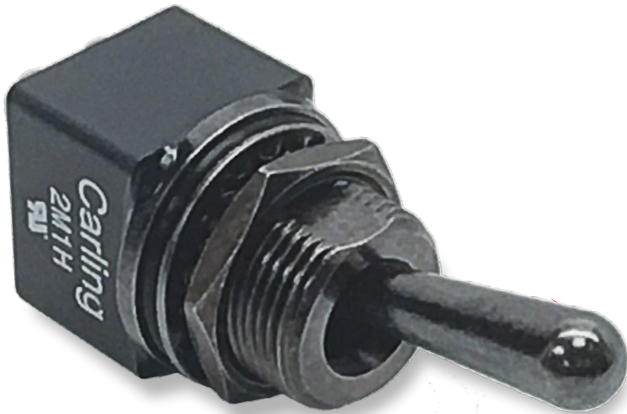
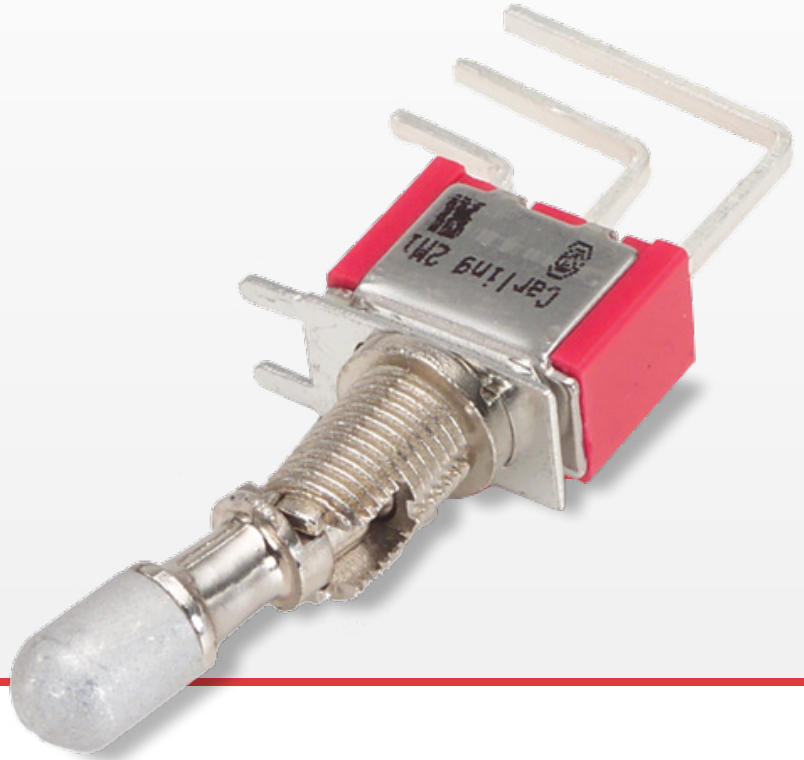

The 2M family of miniature toggle switches is composed of three switch series; the 2M1-Series miniature toggle switch, the 2MS-Series sealed miniature toggle switch, and the 2M1H-Series premium sealed miniature toggle switch. These series all feature PC mounting and offer a variety of ratings, circuits, contact materials, terminal platings, toggle styles and lengths, and optional color caps.

1-2	.4-5	125, 250	28
Poles	Amps	VAC	VDC

Typical Applications

- Instrumentation
- Telecommunications
- Networking
- Medical Equipment
- Military

Tech Specs



2MIH-Series
Premium Sealed
Miniature
Toggle Switch

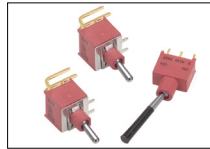

2MS-Series
Sealed
Miniature
Toggle Switch

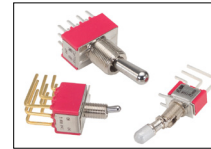

2MI-Series
Miniature
Toggle Switch

Electrical

Contact Rating	refer to ordering scheme
Electrical Life	50,000 make & break cycles @ full load
Contact Resistance	10 mΩ max. initial @ 2-4 VDC 100mA for both silver & gold plated contacts
Insulation Resistance	1000 MΩ min.
Dielectric Strength	1500 Volts RMS @ sea level

Physical

Operating Temperature	-30°C to +85°C
Index of Protection	2MIH-Series: IP67 2MS-Series: IP67
Solder Heat Resistance	MIL-STD-202, Method 210
Actuator Travel	25°

Material

Case	2MIH-Series & 2MI-Series: Dially phthalate (DAP) (UL 94V-0) 2MS-Series: Glass filled nylon 6/6, flame retardant, heat stabilized (UL 94V-0)
Toggle	2MIH-Series: Brass, black finish with o-ring seal 2MS-Series: Brass, chrome plated, internal o-ring sealed 2MI-Series: Brass, chrome plated
Bushing	2MIH-Series: Brass, black finish with o-ring seal 2MS-Series: Glass filled nylon 6/6, flame retardant, heat stabilized (UL 94V-0) 2MI-Series: Brass, nickel plated
Housing	Stainless Steel
Bracket	2MS-Series: Nylon (UL 94V-0) 2MI-Series: Stainless Steel
Actuator Retainer	2MS-Series: Stainless Steel
Switch Support	Brass, tin plated
Terminal Seal	Epoxy

Ordering Scheme

Sample Part Number **2MIH - DP1 TJ - BK - M2 R E**

Selection 1 2 3 4 5 6 7

1. SERIES

2MIH Premium Sealed Miniature Toggle Switch

2. POLES / CIRCUIT

() - momentary			
Position:	1	2	3
	2-3, 5-6	Connected Terminals	2-1, 5-4
SP1	ON	NONE	ON
SP2	ON	NONE	(ON)
SP3	ON	OFF	ON
SP4	(ON)	OFF	(ON)
SP5	ON	OFF	(ON)
DP1	ON	NONE	ON
DP2	ON	NONE	(ON)
DP3	ON	OFF	ON
DP4	(ON)	OFF	(ON)
DP5	ON	OFF	(ON)
DP6 *	ON	ON	ON
DP7 *	(ON)	ON	(ON)
DP8 *	ON	ON	(ON)

*Center position connects 2-3, 5-4

3. ACTUATOR STYLE

TJ .709" [18 mm] length **TK** .512" [13.00 mm] length

4. BUSHING

BK .386" [9.80 mm] threaded, flat

5. TERMINATION

M1 Solder Lug	M51 Wire Wrap, .750" [19.05mm] length
M2 PCB	M52 Wire Wrap, .964" [24.48mm] length
M3 Quick Connect	M53 Wire Wrap, .425" [10.80mm] length
	M54 Wire Wrap, 1.062" [25.97mm] length

6. CONTACTS / TERMINALS

Contact Material	Terminal Plating	Rating	Approvals
G silver ¹	gold over silver	5A 125VAC or 28VDC, 2A 250VAC	IP67
K gold ^{2,5}	tin ^{4,7}	0.4VA max 20V max (AC/DC)	IP67
P silver ^{1,6}	tin ^{4,7}	5A 125VAC or 28VDC, 2A 250VAC	IP67
Q silver ¹ silver ¹	5A	125VAC or 28VDC, 2A 250VAC	IP67
R gold ² gold ³	0.4VA max	20V max (AC/DC)	IP67

7. EPOXY SEAL

E Epoxy Seal

Notes: Switches supplied with (1) 2MI-HDW4 hex nut and (1) 3MNH-WCP-0872 O-Ring
 1 Movable contact and terminal platings: silver over copper alloy
 2 Movable contact and terminal platings: gold over nickel over copper alloy
 3 Terminal platings: gold over nickel over copper alloy
 4 Terminal platings: tin over copper alloy
 5 Terminal contact platings: gold over nickel alloy
 6 Terminal contact platings: silver over nickel alloy
 7 Tin option not available with M1 & M3 terminations.

[Configure Complete Part Number >](#)

[Browse Standard Parts >](#)

Ordering Scheme

Sample Part Number **2MS - WSP 1 - T1 - B4 - M1 G E**

Selection 1 2 3 4 5 6 7 8

1. SERIES

2MS Sealed Miniature Toggle Switch

2. POLES

WSP Single pole - uses terminals 1, 2 & 3
WDP Double pole - uses terminals 1, 2, 3, 4, 5 & 6
W3P Three pole - uses terminals 1, 2, 3, 4, 5, 6, 7, 8 & 9

3. CIRCUIT

() - momentary
Position: **1** **2** **3**
 2-3, 5-6 Connected Terminals 2-1, 5-4
1 ON NONE ON
2 ON NONE (ON)
3 ON OFF ON
4 (ON) OFF (ON)
5 ON OFF (ON)

4. ACTUATOR STYLE

T1 Round Bat **P1** Plastic Anti-Static .496" length
T2 Round Short Bat **P2** Plastic Anti-Static .299" length
T9 Long Black Plastic .492" length

5. BUSHING

B1 Threaded, Keyway **B4** Unthreaded, Short, Keyway, Flat

Notes:
 B1 Bushing switches supplied with (2) 2MI-HDW2 nuts, (1) 2MI-HDW11 washer and (1) 2MI-HDW15 locking ring. See page 76-77.
 1 Movable contact & terminal platings: silver over copper alloy
 2 Movable contact & terminal platings: gold over nickel over copper alloy
 3 Terminal platings: tin over nickel over copper alloy
 4 Tin option not available with M1 terminal

6. TERMINATION

M1⁴ Solder Lug **VS21** Vertical, Snap-In, .460" [11.70mm]
M2 PCB **VS3** Vertical, .630" [16mm]
M3 Quick Connect **VS31** Vertical, Snap-In, .630" [16mm]
M51 Wire Wrap, .750" [19.05mm] **U2** Vertical, .551" [14mm] - only 3PDT
M52 Wire Wrap, .964" [24.48mm] **VS4** Vertical, .461" [11.70mm]
M53 Wire Wrap, .425" [10.80mm] **VS41** Vertical, Snap-In, .461" [11.70mm]
M54 Wire Wrap, 1.062" [25.97mm] **U4** Vertical, .551" [14mm] - only 3PDT
M6 Right Angle, PC Thru-Hole **VS5** Vertical, .630" [16mm]
M61 Right Angle, Snap-In **VS51** Vertical, Snap-In, .630" [16mm]
M7 Vertical, Right Angle, PC Thru-Hole
M71 Vertical, Right Angle, Snap-In
VS2 Vertical, .461" [11.70mm]

7. CONTACTS / TERMINALS

Contact Material	Terminal Plating	Rating	Approvals
G silver ¹	gold over silver	5A 125VAC or 28VDC, 2A 250VAC	us, IP67
K gold ²	tin 3, 4	0.4VA max 20V max (AC/DC)	IP67
P silver ¹	tin 3, 4	5A 125VAC or 28VDC, 2A 250VAC	us, IP67
R gold ²	gold ²	0.4VA max 20V max (AC/DC)	IP67

8. EPOXY SEAL

E Epoxy Seal **0** without Epoxy Seal

[Configure Complete Part Number >](#)

[Browse Standard Parts >](#)

Sample Part Number **2M1 - SP 1 - T1 - B1 - M1 Q E**

Selection 1 2 3 4 5 6 7 8

1. SERIES

2M1 Miniature Toggle Switch

2. POLES

SP Single pole - uses terminals 1, 2 & 3
DP Double pole - uses terminals 1, 2, 3, 4, 5 & 6
3P Three pole - uses terminals 1, 2, 3, 4, 5, 6, 7, 8 & 9
4P Four pole - uses terminals 1, 2, 3, 4, 5, 6, 7, 8, 9, 10, 11 & 12

3. CIRCUIT

() - momentary
Position: **1** **2** **3**
 2-3, 5-6, 8-9, 11-12 Connected Terminals 2-1, 5-4, 8-7, 11-10
1 ON NONE ON
2 ON NONE (ON)
3 ON OFF ON
4 (ON) OFF (ON)
5 ON OFF (ON)
6* ON ON ON
7* (ON) ON (ON)
8* ON ON (ON)

*Available with DP and 4P switches only. Center position connects 2-3, 5-4, 8-9, 11-10

4. ACTUATOR STYLE

T1 Round Bat **T7** Large Bat (B0 bushing)
T2 Round Short Bat **T8** X-Large Bat (B0 bushing)
T3 Paddle **T9** Black Plastic
T4 Medium Paddle **T0** Rectangular
TA Locking Lever **TA** Locking Lever
T5 Long Paddle **TI** Locking Lever
T6 Flat (B1,B2,B5,BA,BB,BE) **TL** Locking Lever

Notes: B1 Bushing switches supplied with (2) 2MI-HDW2 nuts, (1) 2MI-HDW11 washer and (1) 2MI-HDW15 locking ring.
 1 Movable contact & terminal platings: silver over copper alloy
 2 Movable contact & terminal platings: gold over nickel over copper alloy
 3 Terminal platings: tin over nickel over copper alloy
 4 Tin option not available with M1 terminal Movable contact & terminal platings: silver over copper alloy
 5 Movable contact & terminal platings: gold over nickel over copper alloy
 6 Terminal platings: tin over nickel over copper alloy
 7 Tin option not available with M1 terminal

5. BUSHING

B1 Threaded Standard, keyway **B9** Splashproof
B2 Non-Threaded Standard, keyway **B0** 15/32" Threaded (Standard for T7 & T8 actuator styles)
B3 Threaded Short, keyway **BA** Threaded for T6
B4 Non-Threaded Short, keyway **BA** Threaded for T6
B5 High Torque, 7.5mm, flat **BB** Non-Threaded for T6
B6 High Torque, 8.0mm, keyway **BE** Threaded Hi Torque for T6
B7 Long threaded **BL** Threaded, Locking
B8 Metric

6. TERMINATION

M1⁴ Solder Lug **VS21** Vertical, Snap-In, .460" [11.70mm]
M2 PCB **VS3** Vertical, .630" [16mm]
M3 Quick Connect **VS31** Vertical, Snap-In, .630" [16mm]
M51 Wire Wrap, .750" [19.05mm] **U2** Vertical, .551" [14mm] - only 3PDT
M52 Wire Wrap, .964" [24.48mm] **VS4** Vertical, .461" [11.70mm]
M53 Wire Wrap, .425" [10.80mm] **VS41** Vertical, Snap-In, .461" [11.70mm]
M54 Wire Wrap, 1.062" [25.97mm] **U4** Vertical, .551" [14mm] - only 3PDT
M6 Right Angle, PC Thru-Hole **VS5** Vertical, .630" [16mm]
M61 Right Angle, Snap-In **VS51** Vertical, Snap-In, .630" [16mm]
M7 Vertical, Right Angle, PC Thru-Hole
M71 Vertical, Right Angle, Snap-In
VS2 Vertical, .461" [11.70mm]

7. CONTACTS / TERMINALS

Contact Material	Terminal Plating	Rating	Approvals
G silver ¹	gold over silver	5A 125VAC or 28VDC, 2A 250VAC	us, IP67
K gold ²	tin 3, 4	0.4VA max 20V max (AC/DC)	N/A
P silver ¹	tin 3, 4	5A 125VAC or 28VDC, 2A 250VAC	us, IP67
Q silver ¹	silver ¹	5A 125VAC or 28VDC, 2A 250VAC	us, IP67
R gold ²	gold ²	0.4VA max 20V max (AC/DC)	N/A

8. EPOXY SEAL

E Epoxy Seal **0** without Epoxy Seal

[Configure Complete Part Number >](#)

[Browse Standard Parts >](#)

Ordering Scheme Accessories

2M-Series Accessories

To order accessories assembled on a switch, specify the switch number followed by the accessory part number and the word "assembled".
Ex: 2M1-SPI-T1-BI-MIQE-T12 ASSEMBLED. To order accessories in bulk, specify the Series, followed by the accessory. Ex: 2M1-T12. See page 76 for dimensional specifications.

Optional Toggle Cap

Sample Part Number 2M1 - T1 2

Selection 1 2 3

1. SERIES

2M1 Fits 2MIH, 2MS or 2M1

2. TOGGLE CAP SIZE

T1 10.6 mm **T2** 7.6 mm

3. CAP COLOR

1	White	5	Yellow
2	Black	6	Green
3	Red	7	Blue

Optional Dress and Knurled Nuts

Sample Part Number 2M1 - HDW3

Selection 1 2

1. SERIES

2M1 Fits 2MIH, 2MS or 2M1

2. NUT

HDW3 Dress nut for 1/4" bushing
HDW5 Knurled nut for 15/32" bushing (2M1-Series only)

Optional Rubber Seals

Sample Part Number 2M1 - E1A

Selection 1 2

1. SERIES

2M1 Fits 2MIH, 2MS or 2M1

2. RUBBER BOOT SEAL

E1A 1/4 - 40" UNS bushing (Not available for B0 bushing option)
K1 Metric M6 bushing (B8 bushing only)
YE1D 15/32 - 32" UNS bushing (TJ, TK and B0 bushings only)
YE1E 15/32 - 32" UNS bushing 1/2 boot (T7, T8, TJ, TK and B0 bushings only)

Sample Part Number 3MNH - WCP-0872

Selection 1 2

1. SERIES

3MNH Fits 3MNH or 2MIH

2. RUBBER O-RING

WCP-0872 For 15/32 bushing option

Dimensional Specs

inches [millimeters]

Single Pole

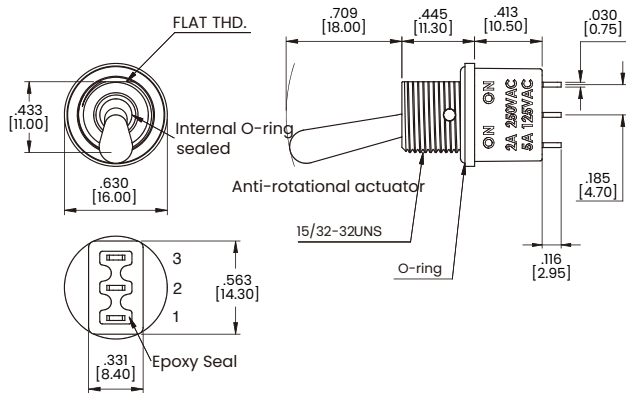

Double Pole

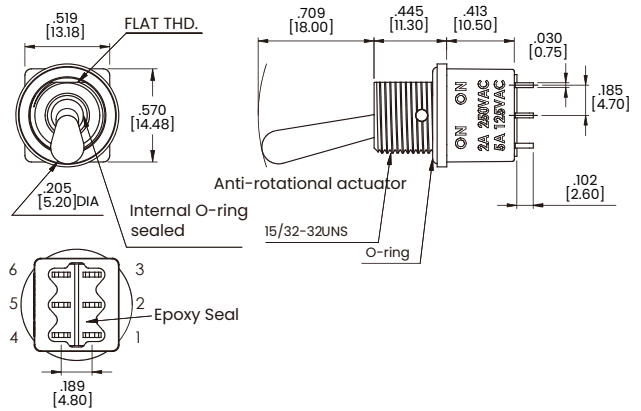

Actuator Options

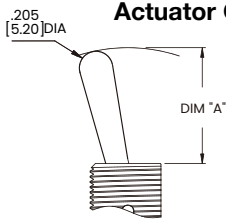

OPTION CODE	DIM. "A"
TJ	.709 [18.00]
TK	.512 [13.00]

Bushing Options & Mounting

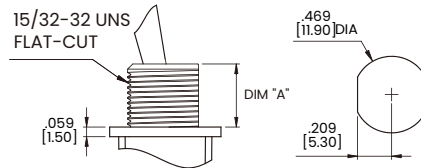

OPTION CODE	DIM. "A"
BK	.386 [9.80]

Termination Options

M1 Standard Solder Lug

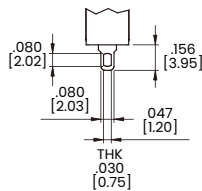

M2 PC Thru-Hole

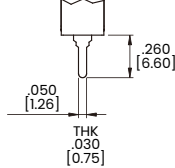

M3 Quick Connect

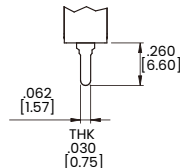

M5 Wire Wrap

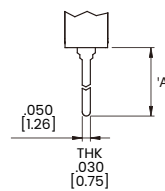

OPTION CODE	DIM. "A"
M5-1	.750 [19.05]
M5-2	.964 [24.48]
M5-3	.425 [10.80]
M5-4	1.062 [26.97]

Dimensional Specs

inches [millimeters]

Single Pole

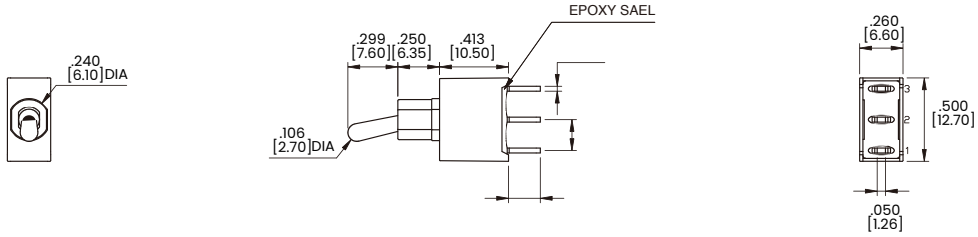

Double Pole

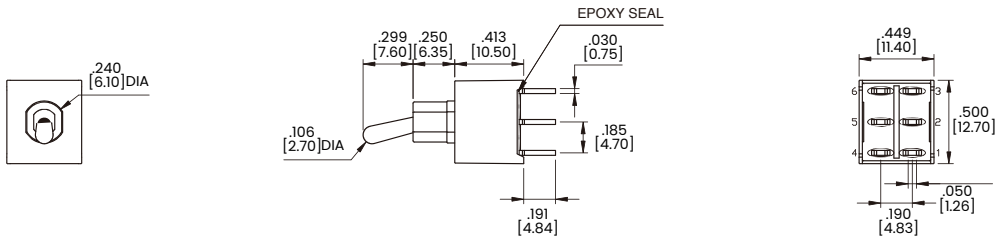

Three Pole

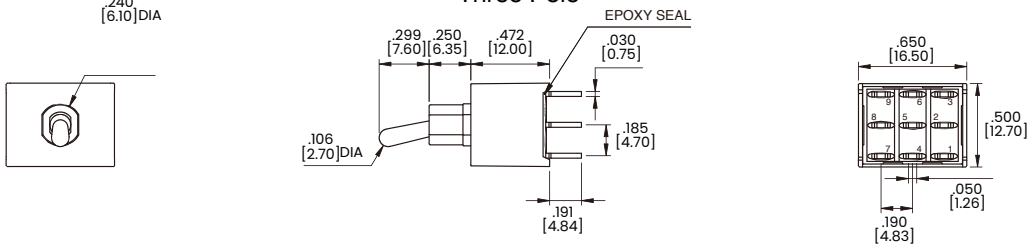

Actuator Options

T1

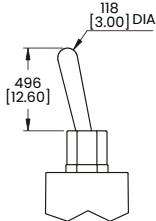

T2

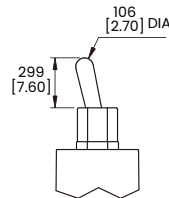

T9 with Plastic Cap

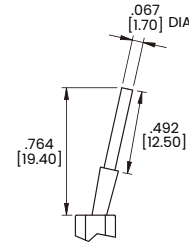

NO.	COLOR
1	White
2	Black(std.)
3	Red
4	Orange
5	Yellow
6	Green
7	Blue
8	Brown
9	Gray

P1 Plastic Toggle

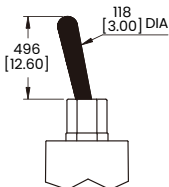

P2 Plastic Toggle

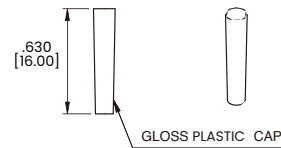
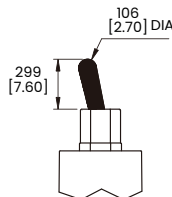

* Shown with B4 bushing. Subtract 0.75" (1.90mm) from actuator height for B1 bushing.

Dimensional Specs

inches [millimeters]

Bushing Options

B1

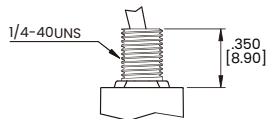

B4

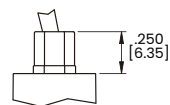

Termination Options

M1 Standard Solder Lug

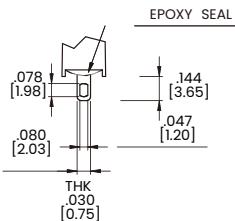

M2 PC Thru-Hole

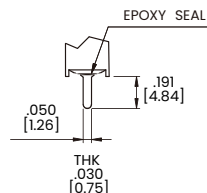

M3 Quick Connect

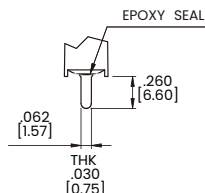

M5 Wire Wrap

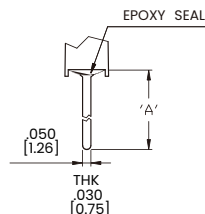

OPTION CODE	DIM.'A'
M5-1	.750 [19.05]
M5-2	.964 [24.48]
M5-3	.425 [10.80]
M5-4	1.062 [26.97]

M6 Single Pole

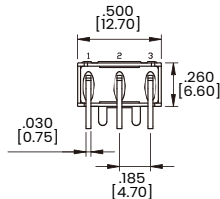
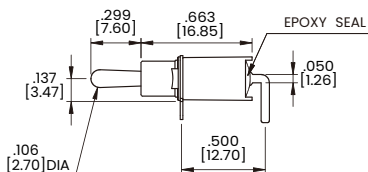
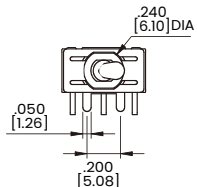

P.C.MOUNTING

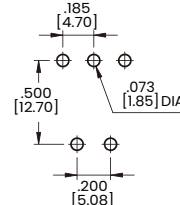

M6 Double Pole

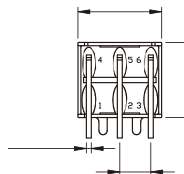
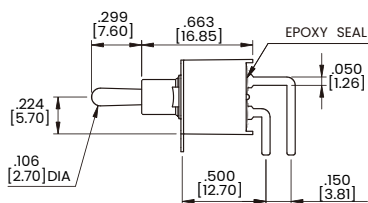
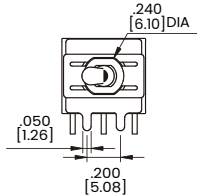

P.C.MOUNTING

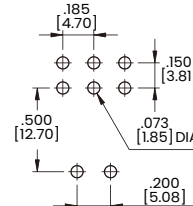

M6 Three Pole

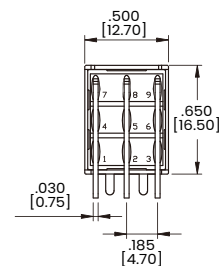
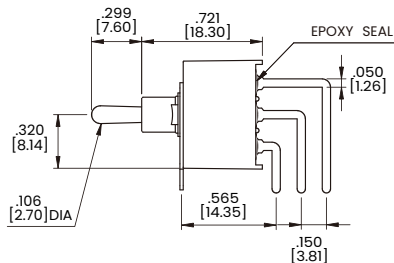
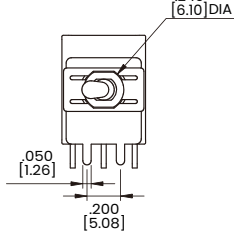

P.C.MOUNTING

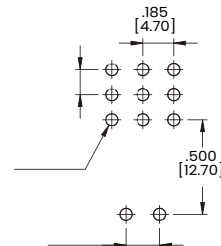

M7 Single Pole

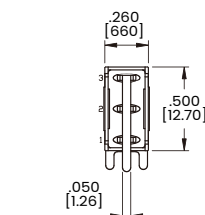
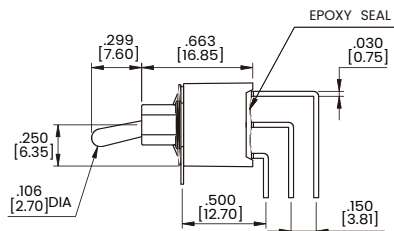
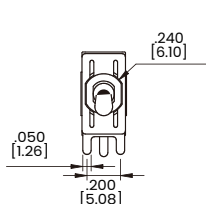

P.C.MOUNTING

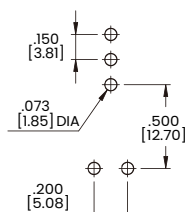

Dimensional Specs

inches [millimeters]

Termination Options

M7 Double Pole

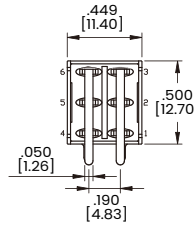
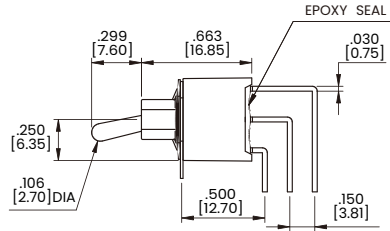
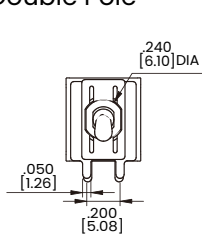

P.C.MOUNTING

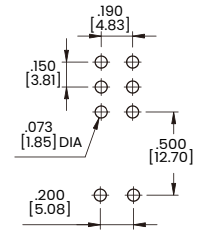

M7 Three Pole

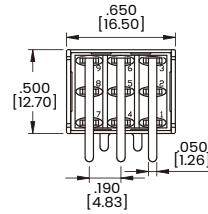
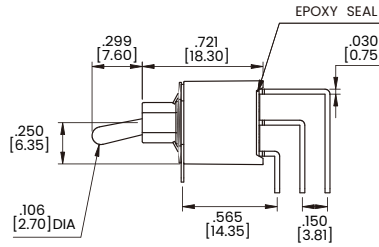
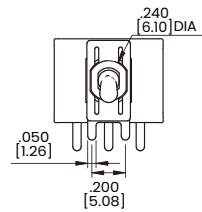

P.C.MOUNTING

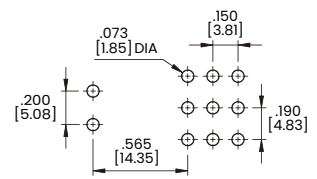

VS2-VS3 Single Pole

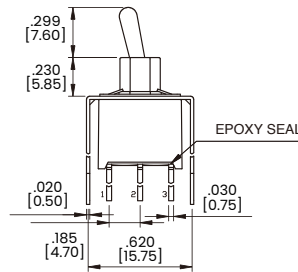
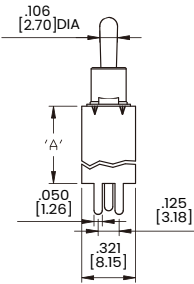

OPTION CODE	DIM. 'A'
VS2	.461 [11.70]
VS3	.630 [16.00]

P.C.MOUNTING

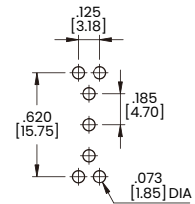

VS2-VS3 Double Pole

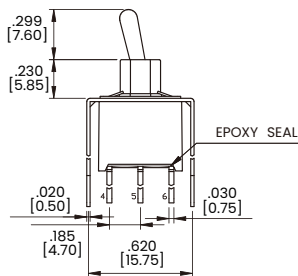
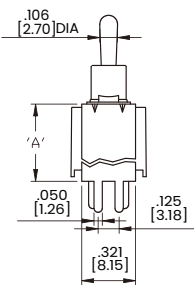

OPTION CODE	DIM. 'A'
VS2	.461 [11.70]
VS3	.630 [16.00]

P.C.MOUNTING

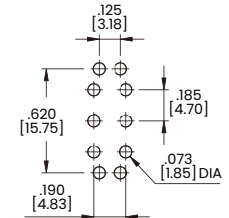

U2-VS3 Three Pole

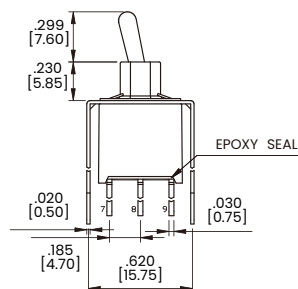
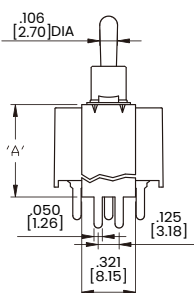

OPTION CODE	DIM. 'A'
U2	.551 [14.00]
VS3	.630 [16.00]

P.C.MOUNTING

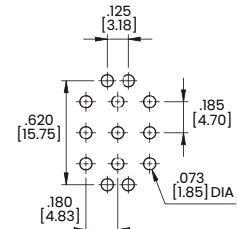

Dimensional Specs

inches [millimeters]

Termination Options

VS4-VS5 Single Pole

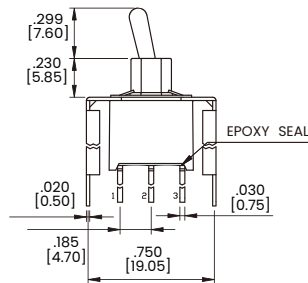
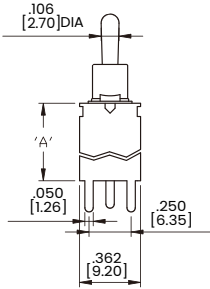

OPTION CODE	DIM.'A'
VS4	.461 [11.70]
VS5	.630 [16.00]

P.C.MOUNTING

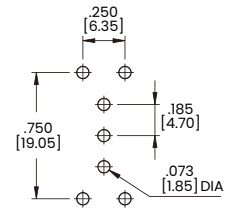

VS4-VS5 Double Pole

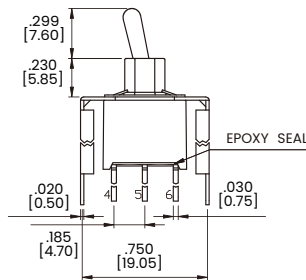
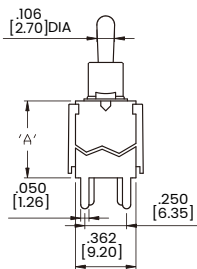

OPTION CODE	DIM.'A'
VS4	.461 [11.70]
VS5	.630 [16.00]

P.C.MOUNTING

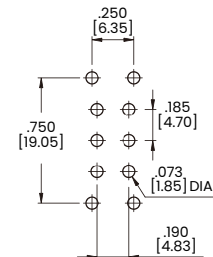

U4-VS5 Three Pole

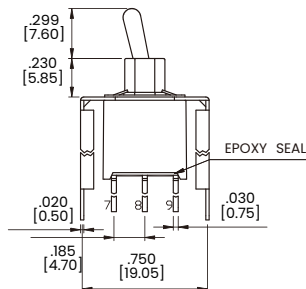
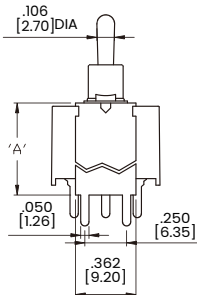

OPTION CODE	DIM.'A'
U4	.551 [14.00]
VS5	.630 [16.00]

P.C.MOUNTING

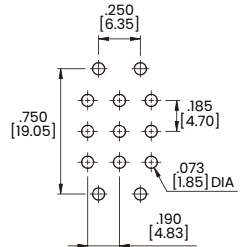

Snap-In Termination Options

M61

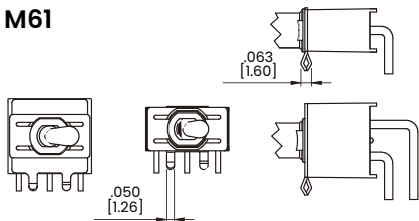

VS21, VS31

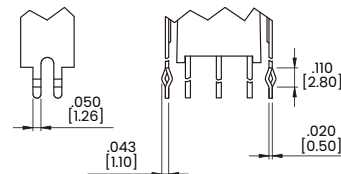

M71

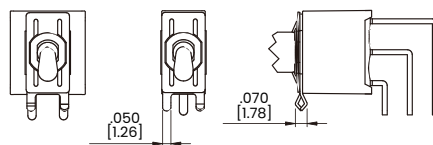

VS41, VS51

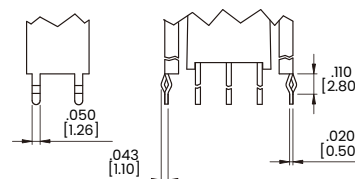

* PC Mounting for M61, M71, VS21, VS31, VS41, VS51 refer to M6, M7, VS2, VS3, VS4, VS5 respectively.

Dimensional Specs

inches [millimeters]

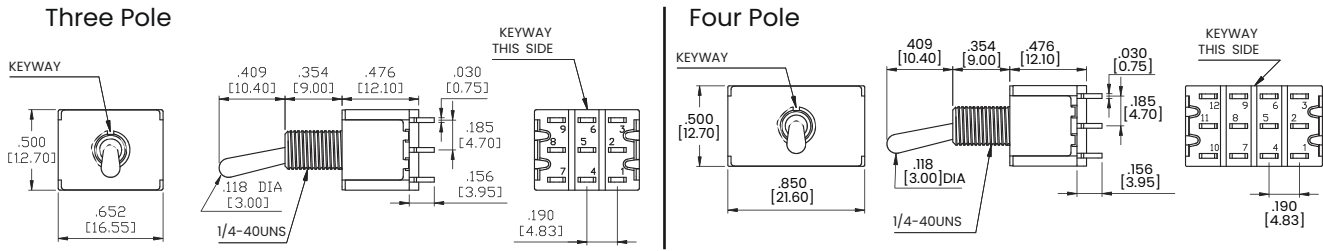
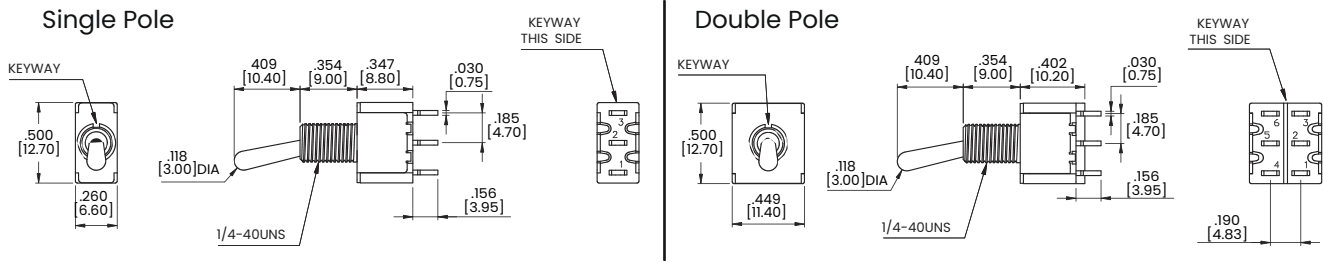

Actuator Options for Panel Rear Mount

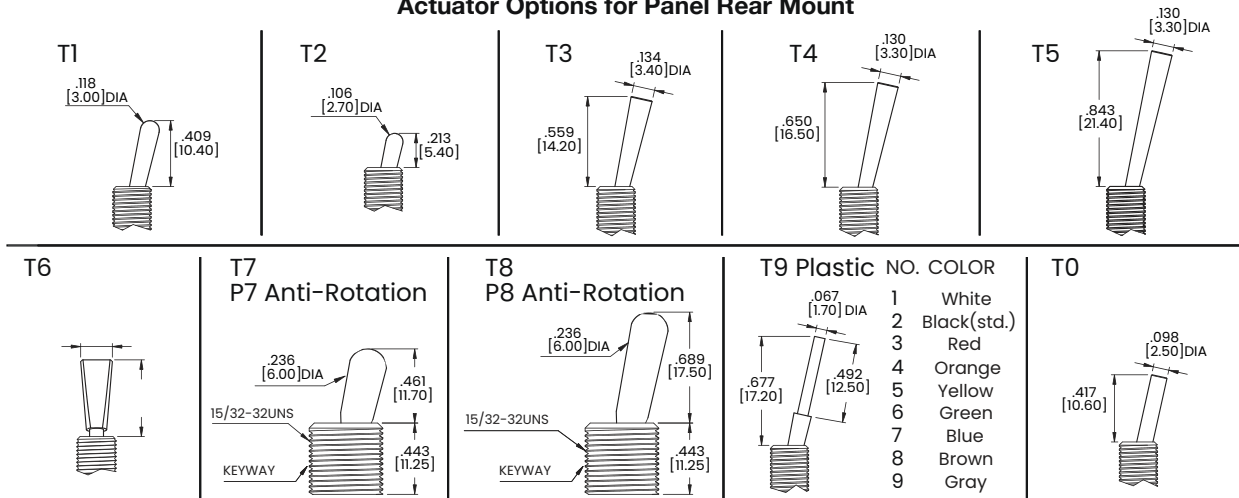

* T6 actuator is available with B1, B2, B5, B6, BA, BB & BE bushing. Actuator length shown for T1-T5, T9 and T10 is with B1 bushing. T7, T7, P8 does not require a bushing code.

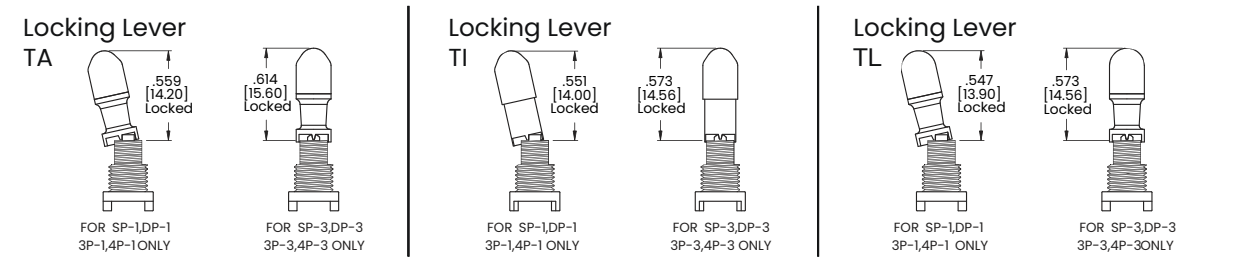

Bushing Options

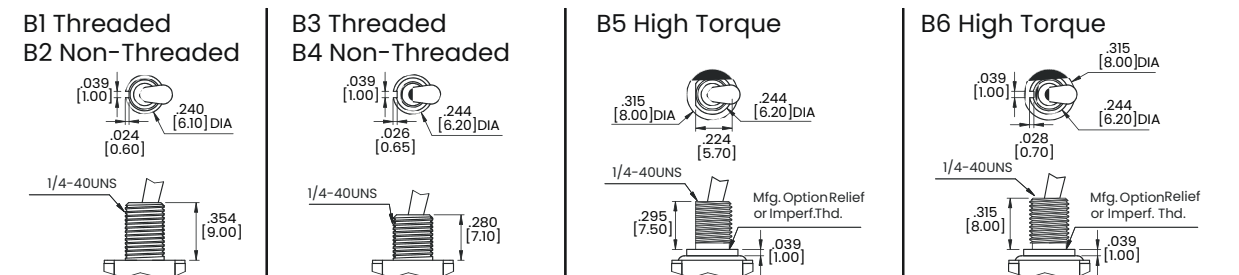

Dimensional Specs

inches [millimeters]

B7 Long

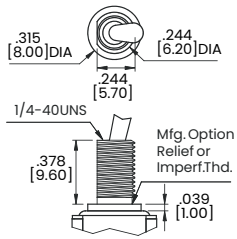

B8 Metric

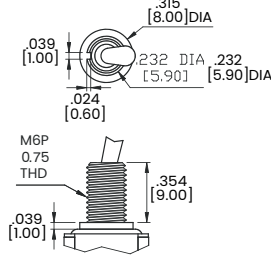

B9 Splash-Proof

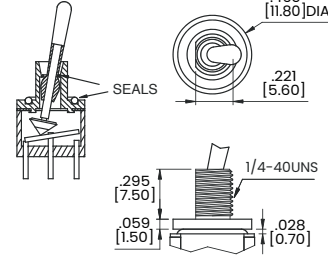

BL Locking Lever

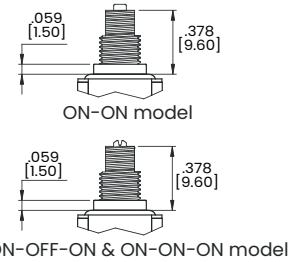

BA Threaded for T6

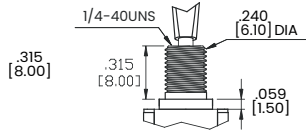

BB Non-Threaded for T6

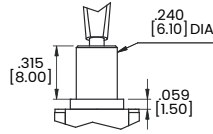

BB High Torque for T6

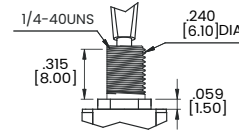

Panel Mounting

1/4 INCH BUSHING

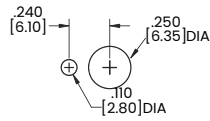
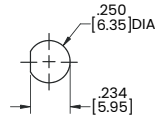
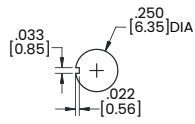

15/32 INCH BUSHING

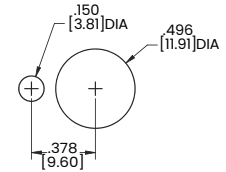
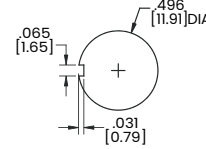

Termination Options

M1 Standard Solder Lug

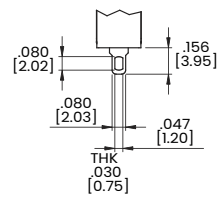

M2 PC Thru-Hole

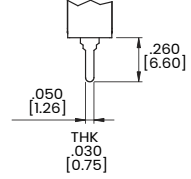

M3 Quick Connect

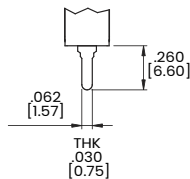

M5 Wire Wrap

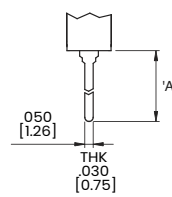

OPTION CODE	DIM. 'A'
M5-1	.750 [19.05]
M5-2	.964 [24.48]
M5-3	.425 [10.80]
M5-4	1.062 [26.97]

M6 Single Pole

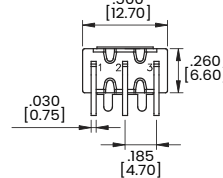
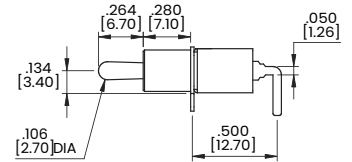
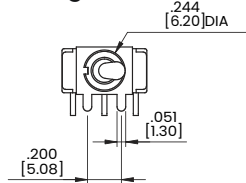

P.C.MOUNTING

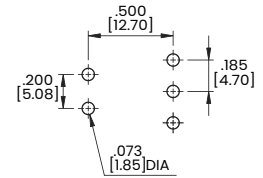

M6 Double Pole

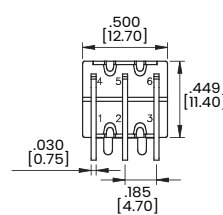
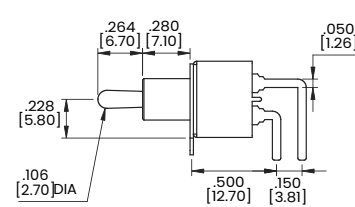
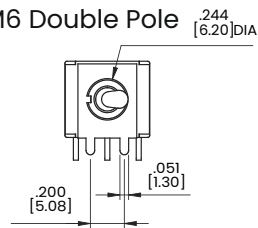

P.C.MOUNTING

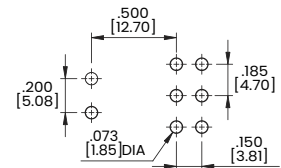

Dimensional Specs

inches [millimeters]

Termination Options

M6 Three Pole

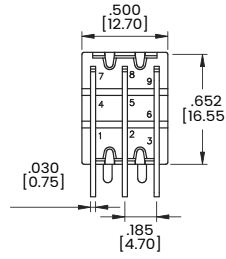
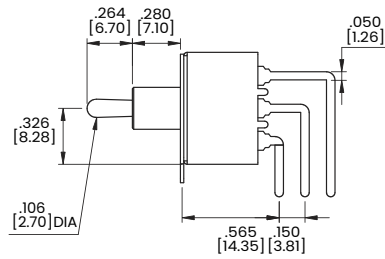
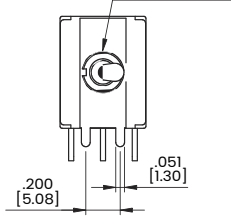

P.C.MOUNTING

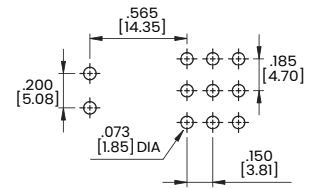

M7 Single Pole

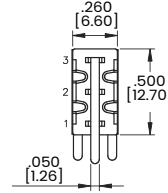
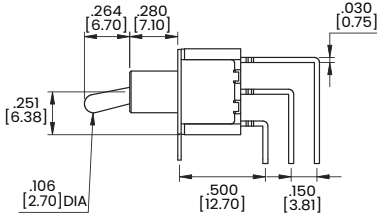
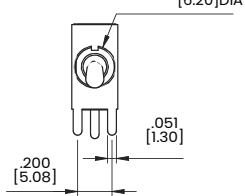

P.C.MOUNTING

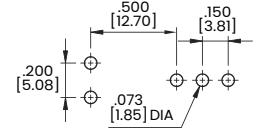

M7 Double Pole

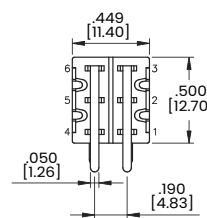
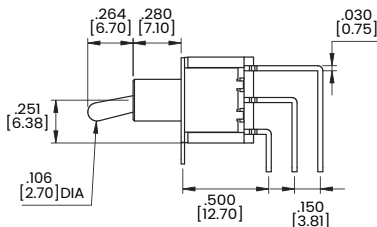
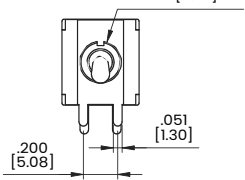

P.C.MOUNTING

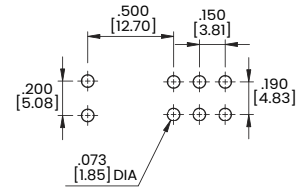

M7 Three Pole

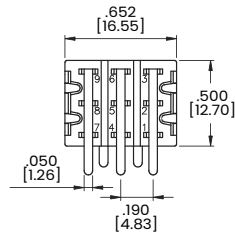
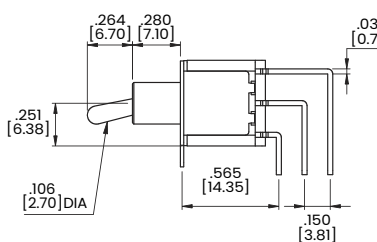
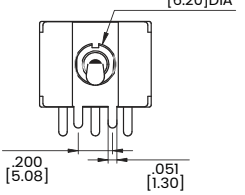

P.C.MOUNTING

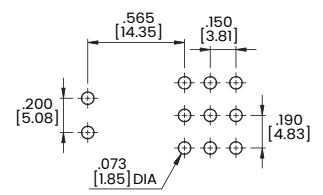

M7 Four Pole

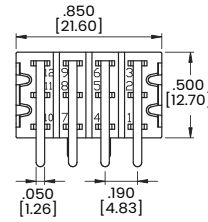
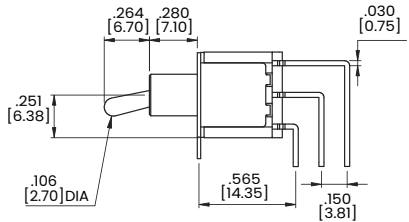
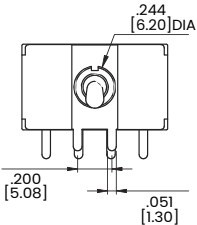

P.C.MOUNTING

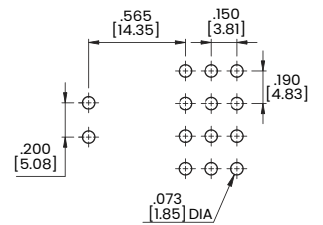

VS2-VS3 Single Pole

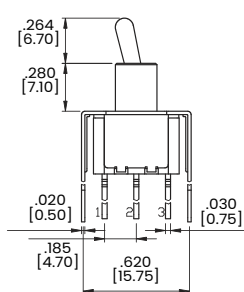
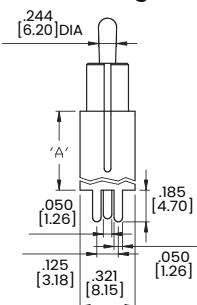

OPTION CODE	DIM: 'A'
VS2	.461 [11.70]
VS3	.630 [16.00]

P.C.MOUNTING

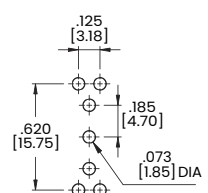

Dimensional Specs

inches [millimeters]

Termination Options

VS2-VS3 Double Pole

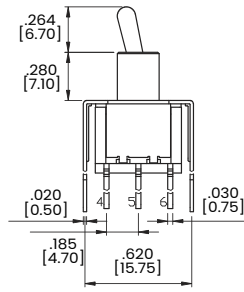
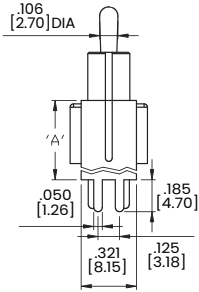

OPTION CODE	DIM.'A'
VS2	.461 [11.70]
VS3	.630 [16.00]

P.C.MOUNTING

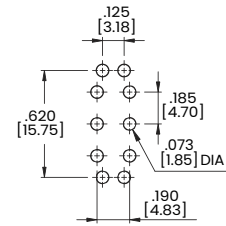

VS4-VS5 Single Pole

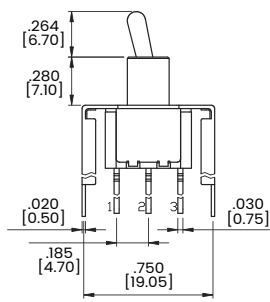
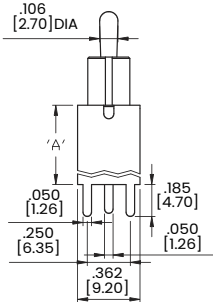

OPTION CODE	DIM.'A'
VS4	.461 [11.70]
VS5	.630 [16.00]

P.C.MOUNTING

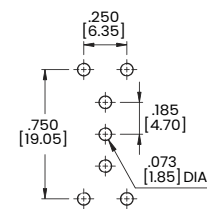

VS4-VS5 Double Pole

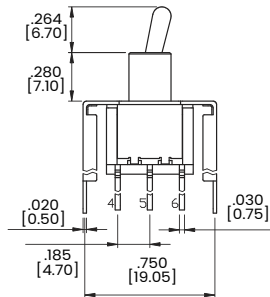
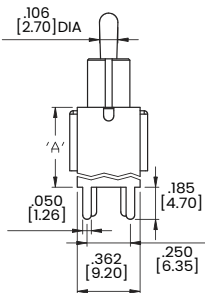

OPTION CODE	DIM.'A'
VS4	.461 [11.70]
VS5	.630 [16.00]

P.C.MOUNTING

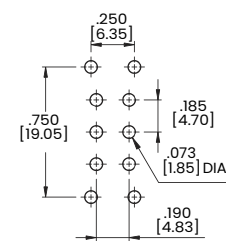

Snap-In Termination Options

M61 (available with SP & DP)

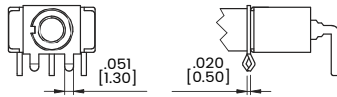

VS21, VS31

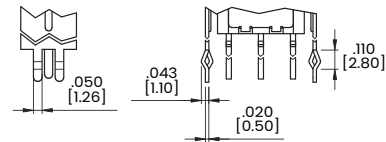

M71 (available with SP & DP)

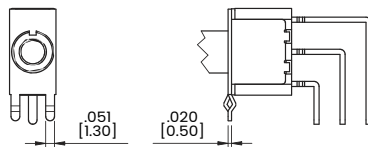

VS41, VS51

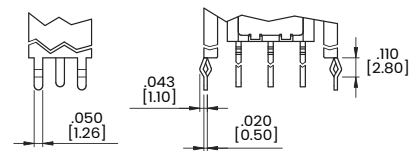

* PC Mounting for M61,M71,VS21,VS31,VS41,VS51 refer to M6,M7,VS2,VS3,VS4,VS5 respectively.

Authorized Sales Representatives and Distributors

Click on a region of the map below to find your local representatives and distributors or visit www.carlingtech.com/findarep.



About Carling

Founded in 1920, Carling Technologies is a leading manufacturer of electrical and electronic switches and assemblies, circuit breakers, electronic controls, power distribution units, and multiplexed power distribution systems. With six ISO9001 and IATF16949 registered manufacturing facilities and technical sales offices worldwide, Carling Technologies Sales, Service and Engineering teams do much more than manufacture electrical components, they engineer powerful solutions! To learn more about Carling please visit www.carlingtech.com/company-profile.

To view all of Carling's environmental, quality, health & safety certifications please visit www.carlingtech.com/environmental-certifications.

Looking for pricing, stock, or lifecycle information?

Click below to explore more details on WIN SOURCE:

- [View 2M1-DP1-T6-B1-M1QE on WIN SOURCE](#)
- [Carling Technologies Information](#)

Optimize Your Supply Chain with WIN SOURCE Solutions

- ✓ Global Sourcing Solution
- ✓ Obsolete Management
- ✓ Cost Control Management
- ✓ Shortage Management
- ✓ Alternative Solution
- ✓ Excess Inventory Management