



# THE DATASHEET OF IR908-7C





## Technical Data Sheet

### 1.5mm Side Face Infrared LED

#### IR908-7C-F

#### Features

- High reliability
- High radiant intensity
- Peak wavelength  $\lambda_p=940\text{nm}$
- 2.54mm Lead spacing
- Low forward voltage
- Pb free
- This product itself will remain within RoHS compliant version.



#### Descriptions

- EVERLIGHT's Infrared Emitting Diode (IR908-7C-F) is a high intensity diode, molded in a water clear plastic package.
- The miniature side-facing device has a chip, that emits radiation from the side of the clear package.

#### Applications

- Mouse
- Optoelectronic switch
- Infrared applied system

#### Device Selection Guide

LED Part No.	Chip	Lens Color
	Material	
IR908-7C-F	GaAlAs	Water clear

**Package Dimensions**

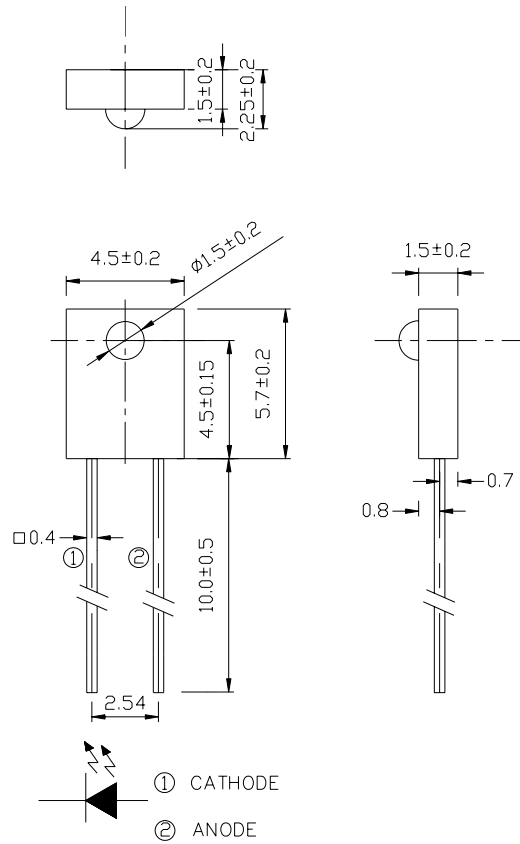

- Notes:** 1.All dimensions are in millimeters  
 2.Tolerances unless dimensions  $\pm 0.25\text{mm}$

**Absolute Maximum Ratings (Ta=25°C)**

Parameter	Symbol	Rating	Units
Continuous Forward Current	$I_F$	50	mA
Peak Forward Current	$I_{FP}$	1.0	A
Reverse Voltage	$V_R$	5	V
Operating Temperature	$T_{opr}$	-25 ~ +85	°C
Storage Temperature	$T_{stg}$	-40 ~ +85	°C
Soldering Temperature	$T_{sol}$	260	°C
Power Dissipation at(or below) 25°C Free Air Temperature	$P_d$	75	mW

- Notes:** \*1: $I_{FP}$  Conditions--Pulse Width  $\leq 100 \mu s$  and Duty  $\leq 1\%$ .  
 \*2:Soldering time  $\leq 5$  seconds.

**Electro-Optical Characteristics (Ta=25°C)**

Parameter	Symbol	Condition	Min.	Typ.	Max.	Units
Light Current	I <sub>c(on)</sub>	I <sub>F</sub> =4mA, V <sub>CE</sub> =3.5V	143	--	1274	μA
Peak Wavelength	λ <sub>p</sub>	I <sub>F</sub> =20mA	--	940	--	nm
Spectral Bandwidth	Δλ	I <sub>F</sub> =20mA	--	45	--	nm
Forward Voltage	V <sub>F</sub>	I <sub>F</sub> =20mA		1.2	1.5	V
Reverse Current	I <sub>R</sub>	V <sub>R</sub> =5V	--	--	10	μA
View Angle	2θ 1/2	I <sub>F</sub> =20mA	--	60	--	deg

**Rank**

Color Code	Ranks	Symbol	Min	Typ	Max	Unit	Test Condition
Red	E1	I <sub>c(on)</sub>	143	---	255	μA	I <sub>F</sub> =4mA, V <sub>CE</sub> =3.5V
Blue	E2	I <sub>c(on)</sub>	214	---	343	μA	I <sub>F</sub> =4mA, V <sub>CE</sub> =3.5V
Yellow	E3	I <sub>c(on)</sub>	286	---	431	μA	I <sub>F</sub> =4mA, V <sub>CE</sub> =3.5V
Silver	E4	I <sub>c(on)</sub>	357	---	519	μA	I <sub>F</sub> =4mA, V <sub>CE</sub> =3.5V
Green	E5	I <sub>c(on)</sub>	428	---	608	μA	I <sub>F</sub> =4mA, V <sub>CE</sub> =3.5V
Purple	E6	I <sub>c(on)</sub>	500	---	696	μA	I <sub>F</sub> =4mA, V <sub>CE</sub> =3.5V
White	E7	I <sub>c(on)</sub>	571	---	784	μA	I <sub>F</sub> =4mA, V <sub>CE</sub> =3.5V

**Rough ranks**

Parameter	Min	Max	Unit	Test Condition
7-2	306	441	μA	I <sub>F</sub> =4mA, V <sub>CE</sub> =3.5V
7-1	347	550	μA	I <sub>F</sub> =4mA, V <sub>CE</sub> =3.5V
6-2	465	750	μA	I <sub>F</sub> =4mA, V <sub>CE</sub> =3.5V
6-1	650	1274	μA	I <sub>F</sub> =4mA, V <sub>CE</sub> =3.5V

**Typical Electro-Optical Characteristics Curves**

Fig.1 Forward Current vs. Ambient Temperature

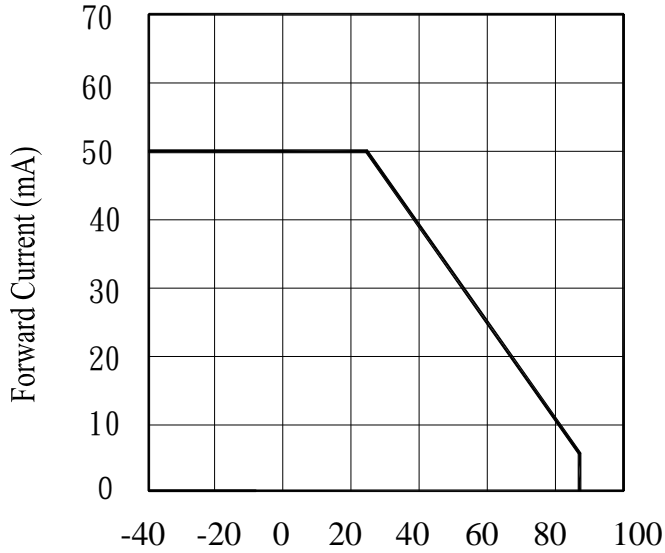

Fig.2 Spectral Distribution

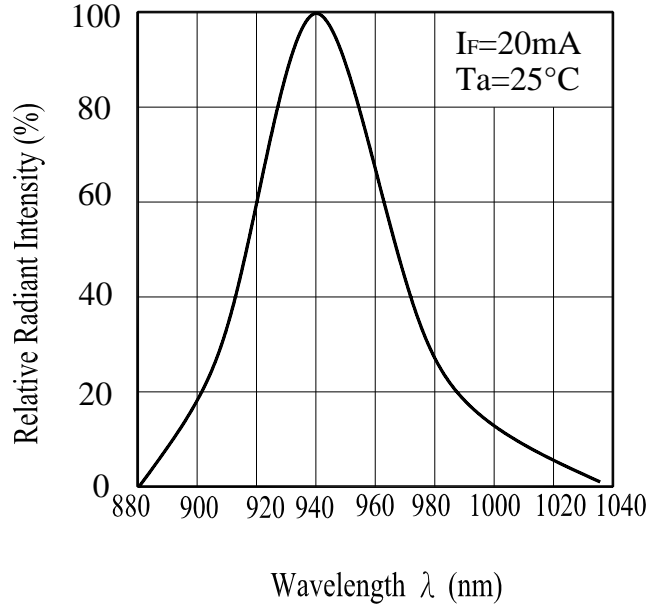

Fig.3 Peak Emission Wavelength vs. Ambient Temperature

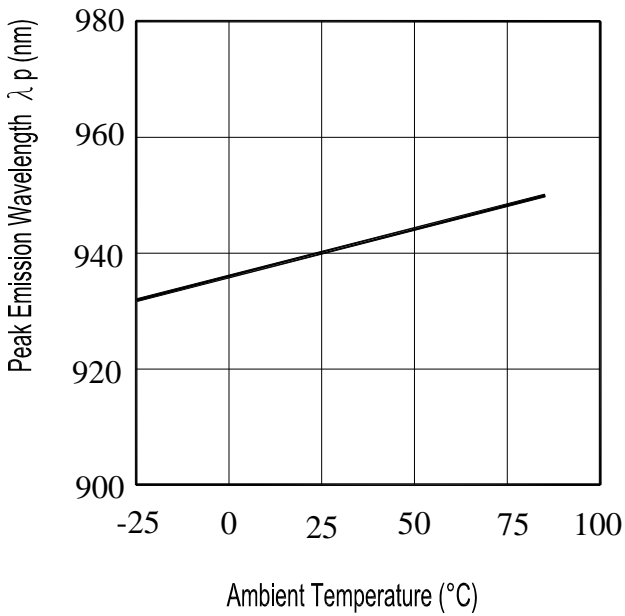
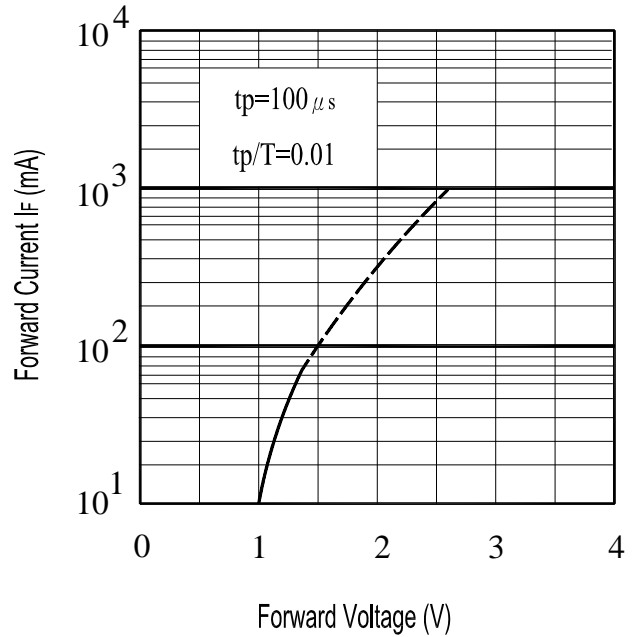

Fig.4 Forward Current vs. Forward Voltage



**Typical Electro-Optical Characteristics Curves**

Fig.8 Forward Current vs. Ambient Temperature(°C)

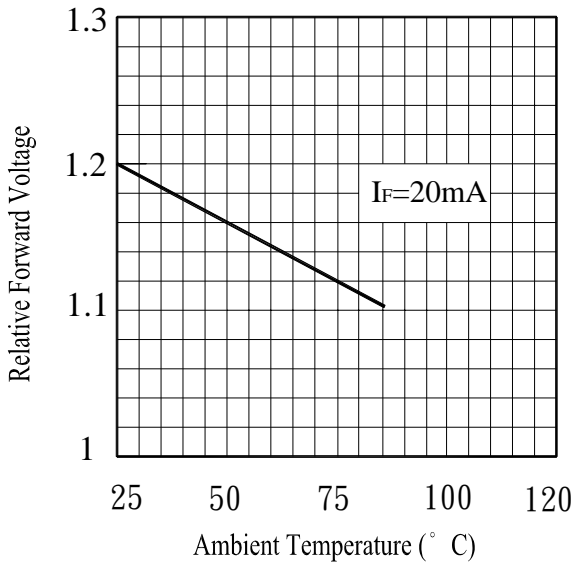
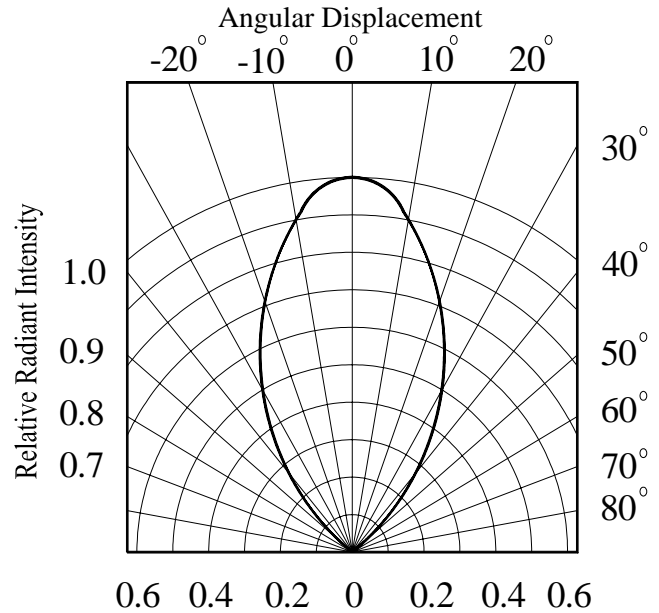

Fig.6 Relative Radiant Intensity vs. Angular Displacement



**Test Method For  $I_{C(ON)}$ :**

Condition:  $I_F=4mA, V_{CE}=3.5V$

The intensity testing method for infrared emitting diode

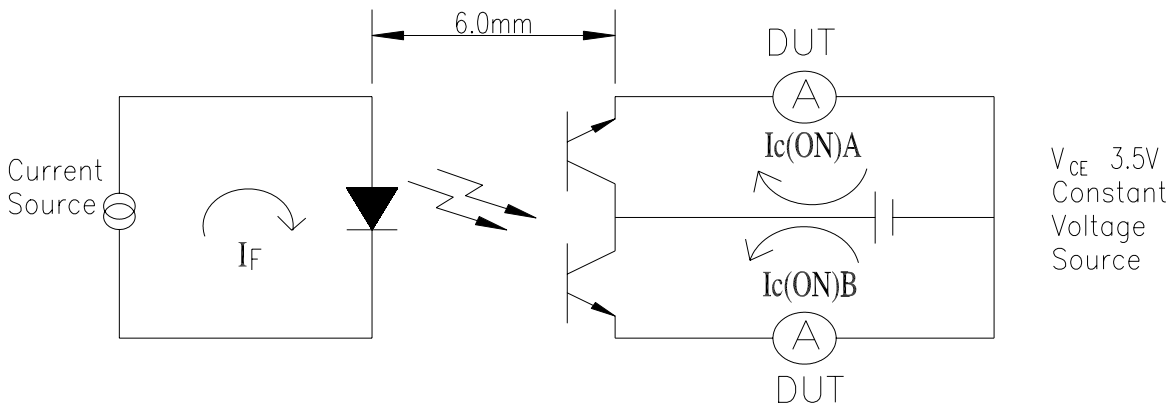







**Packing Quantity Specification**

- 1. 1000PCS/1Bag,10Bag/1Box
- 2. 10Boxes/1Carton

**Label Form Specification**

		
CPN:		CPN: Customer's Production Number
P/N:		P/N : Production Number
		QTY: Packing Quantity
IR908-7C-F		CAT: Ranks
QTY:		HUE: Peak Wavelength
LOT NO:		REF: Reference
		LOT No: Lot Number



**Notes**

- 1. Above specification may be changed without notice. EVERLIGHT will reserve authority on material change for above specification.
- 2. When using this product, please observe the absolute maximum ratings and the instructions for using outlined in these specification sheets. EVERLIGHT assumes no responsibility for any damage resulting from use of the product which does not comply with the absolute maximum ratings and the instructions included in these specification sheets.
- 3. These specification sheets include materials protected under copyright of EVERLIGHT corporation. Please don't reproduce or cause anyone to reproduce them without EVERLIGHT's consent.

<p><b>EVERLIGHT ELECTRONICS CO., LTD.</b> Office: No 25, Lane 76, Sec 3, Chung Yang Rd, Tucheng, Taipei 236, Taiwan, R.O.C</p>	<p>Tel: 886-2-2267-2000, 2267-9936 Fax: 886-2267-6244, 2267-6189, 2267-6306 <a href="http://www.everlight.com">http://www.everlight.com</a></p>
--	---

## Looking for pricing, stock, or lifecycle information?

Click below to explore more details on WIN SOURCE:

-  [View IR908-7C on WIN SOURCE](#)
-  [Infineon Technologies Information](#)

## Optimize Your Supply Chain with WIN SOURCE Solutions

-  Global Sourcing Solution
-  Obsolete Management
-  Cost Control Management
-  Shortage Management
-  Alternative Solution
-  Excess Inventory Management