



THE DATASHEET OF
3511



.250 (6.4) DIAMETER FUSE CLIPS



Refer to pages 48-51 for Fuse Clip Layout and Mounting Details

1AG, 3AG, 7AG, 8AG THRU HOLE MOUNT TYPES

WITH SNAP-IN PC LEGS



MATERIAL:
.020 (.51) Brass, Tin Plate
UL Current Rating: 15 Amps

CAT. NO. 3513

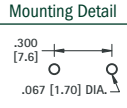
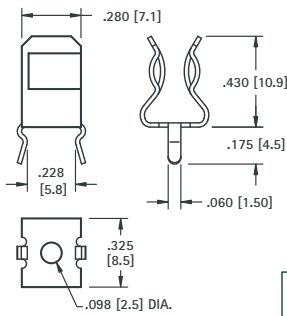

WITH SNAP-IN PC LEGS

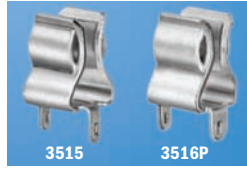

MATERIAL:
.020 (.51) Brass, Tin Plate
UL Current Rating: 15 Amps

CAT. NO.	A	B
3515	.060 (1.5)	.060 (1.5)
3515P	.060 (1.5)	.093 (2.4)
3516P	.060 (1.5)	.120 (3.0)

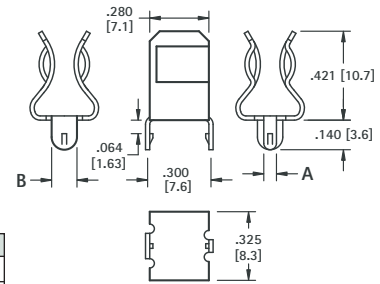

With or Without Orientation Legs

WITH STRAIGHT PC LEGS



MATERIAL:
.020 (.51) Brass, Tin Plate
UL Current Rating: 15 Amps

CAT. NO. 3530

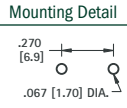
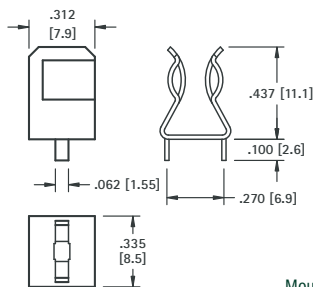

WITH STRAIGHT PC LEGS



MATERIAL:
.020 (.51) Brass, Tin Plate
UL Current Rating: 15 Amps

CAT. NO.	H	L	END STOPS
3510	.421 (10.7)	.140 (3.6)	NO*
3529	.421 (10.7)	.140 (3.6)	YES
3511	.430 (10.9)	.250 (6.4)	NO*
3514	.430 (10.9)	.250 (6.4)	YES

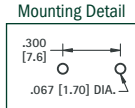
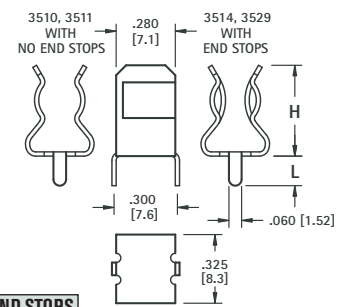

WITH SOLDER LUG

1AG, 3AG, 7AG, 8AG RIVET & SURFACE MOUNT TYPES



MATERIAL:
.020 (.51) Brass, Nickel Plate
UL Current Rating: 15 Amps

CAT. NO.	A	B
3533	Flat	.656 (16.7)
3535	45°	.562 (14.3)

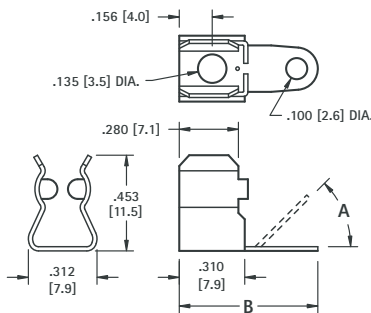

LOW PROFILE



MATERIAL:
.020 (.51) Brass, Nickel Plate
UL Current Rating: 15 Amps

CAT. NO. 3531 (Without End Stops)*

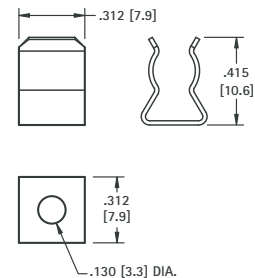

WITHOUT LUG



MATERIAL:
.020 (.51) Brass, Nickel Plate
UL Current Rating: 15 Amps

CAT. NO. 3570

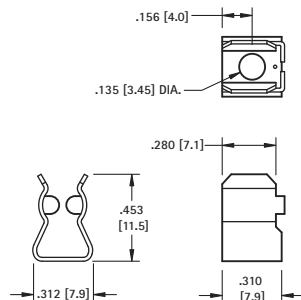

WITH OR WITHOUT END STOPS



MATERIAL:
.020 (.51) Brass, Nickel Plate
UL Current Rating: 15 Amps

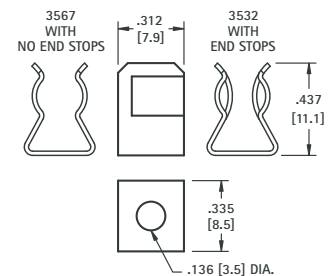

CAT. NO.	END STOPS
3532	YES
3567	NO*



*Fuse clips without end stops are not UL recognized

Looking for pricing, stock, or lifecycle information?

Click below to explore more details on WIN SOURCE:

-  [View 3511](#) on WIN SOURCE
-  [Keystone Electronics](#) Information

Optimize Your Supply Chain with WIN SOURCE Solutions

-  Global Sourcing Solution
-  Obsolete Management
-  Cost Control Management
-  Shortage Management
-  Alternative Solution
-  Excess Inventory Management