



THE DATASHEET OF
J-7-V



J

Ultra Subminiature Basic Switch

Subminiature Models Capable of Large-capacity load of 7A

- Snap-action switch allows large-capacity switching (7A at 250 VAC) in spite of its small size.
- Particularly suitable as control switches for applications where there are restrictions on installation space and weight.

RoHS Compliant

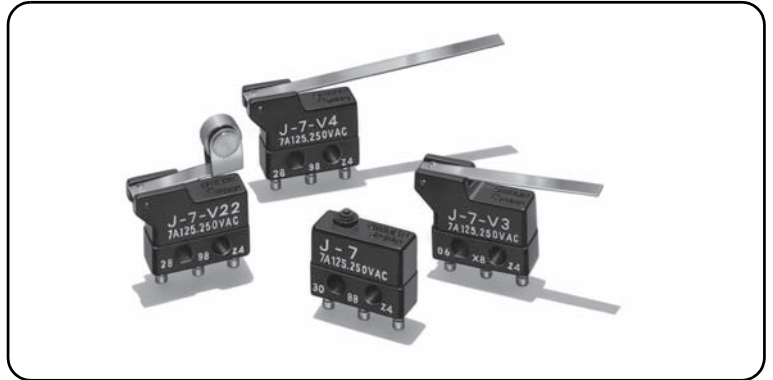







Model Number Legend

J-7-1

1. Actuator

- None : Pin plunger
- V : Short hinge lever
- V22 : Short hinge roller lever
- V2 : Hinge roller lever
- V3 : Hinge lever
- V4 : Long hinge lever

List of Models

Actuator	Model
Pin plunger 	J-7
Short hinge lever 	J-7-V
Short hinge roller lever 	J-7-V22
Hinge roller lever 	J-7-V2
Hinge lever 	J-7-V3
Long Hinge Lever 	J-7-V4

Note. Consult your OMRON sales representative for specific models with safety standard approvals.

Contact Form

- SPDT

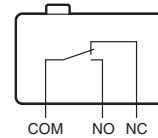

Contact Specifications

Contact	Specification	Rivet
	Material	Silver alloy + Gold plated
	Gap (standard value)	0.35 mm
Minimum applicable load (reference value)		5 VDC 1 mA

Ratings

Rated voltage	Resistive load
125 VAC	7 A
250 VAC	7 A

Note. The above rating values apply under the following test conditions.

- (1) Ambient temperature: 20±2°C
- (2) Ambient humidity: 65±5%
- (3) Operating frequency: 30 operations/min

Approved Safety Standards

Consult your OMRON sales representative for specific models with safety standard approvals.

UL (UL508)/CSA (CSA C22.2 No.55)

Rated voltage	Model	J-7
125 VAC		7 A
250 VAC		7 A

Characteristics

Permissible operating speed		0.05 mm to 1 m/s (for pin plunger models)
Permissible operating frequency	Mechanical	400 operations/min max.
	Electrical	30 operations/min max.
Insulation resistance		100 mΩ min. (at 500 VDC with insulation tester)
Contact resistance (initial value)		15 mΩ max.
Dielectric strength	Between terminals of the same polarity	600 VAC 50/60 Hz for 1 min
	Between current-carrying metal parts and ground	1,500 VAC 50/60 Hz for 1 min
	Between each terminals and non-current-carrying metal parts	1,500 VAC 50/60 Hz for 1 min
Vibration resistance *1	Malfunction	10 to 55 Hz, 1.5 mm double amplitude
Shock resistance *1	Durability	1,000 m/s ² max.
	Malfunction	200 m/s ² max. (pin plunger models)
Durability *2	Mechanical	10,000,000 operations min. (60 operations/min)
	Electrical	50,000 operations min. (30 operations/min)
Degree of protection		IEC IP40
Ambient operating temperature		-10°C to +80°C (at ambient humidity of 60% max.) (with no icing or condensation)
Ambient operating humidity		85% max. (for +5°C to +35°C)
Weight		Approx. 1 g (pin plunger models)

Note. The data given above are initial values.

*1. For the pin plunger models, the above values apply for use at the free position, operating position, and total travel position. For the lever models, they apply for the total travel position. Close or open circuit of the contact is shorter than 1 ms.

*2. For testing conditions, consult your OMRON sales representative.

Dimensions (Unit: mm) and Operating Characteristics

●Pin Plunger J-7

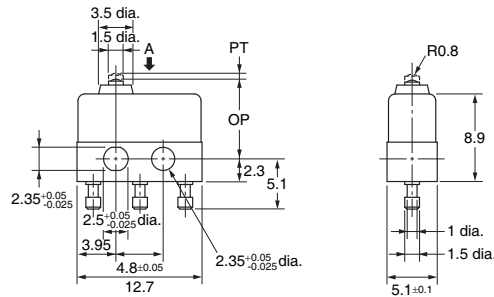
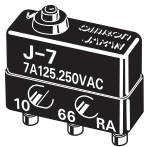

Operating Characteristics		Models	J-7
Operating Force	OF	Max.	1.37 N {140 gf}
Releasing Force	RF	Min.	0.27 N {28 gf}
Pretravel	PT	Max.	0.6 mm
Overtravel	OT	Min.	0.1 mm
Movement Differential	MD	Max.	0.15 mm
Operating Position	OP		8.1±0.3 mm

●Short Hinge Lever J-7-V

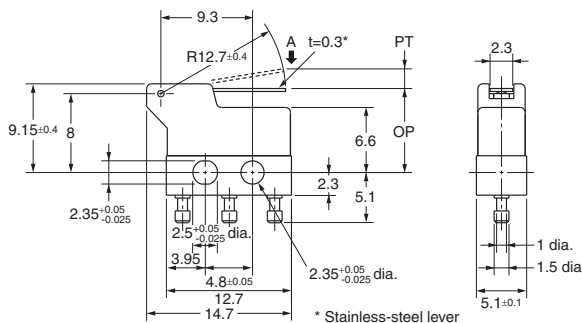
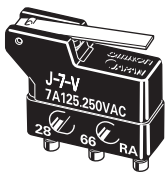

Operating Characteristics		Models	J-7-V
Operating Force	OF	Max.	0.49 N {50 gf}
Releasing Force	RF	Min.	0.09 N {9 gf}
Pretravel	PT	Max.	1.7 mm
Overtravel	OT	Min.	0.35 mm
Movement Differential	MD	Max.	0.5 mm
Operating Position	OP		8.3±1.2 mm

●Hinge Lever J-7-V3

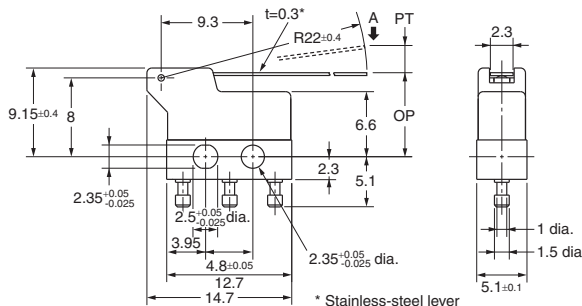
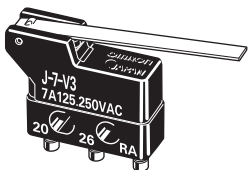

Operating Characteristics		Models	J-7-V3
Operating Force	OF	Max.	0.29 N {30 gf}
Releasing Force	RF	Min.	0.05 N {5 gf}
Pretravel	PT	Max.	2.9 mm
Overtravel	OT	Min.	0.5 mm
Movement Differential	MD	Max.	0.7 mm
Operating Position	OP		8.3±1.9 mm

Note 1. Unless otherwise specified, a tolerance of ±0.2 mm applies to all dimensions.

Note 2. The operating characteristics are for operation in the A direction (↓).

●Long Hinge Lever
J-7-V4

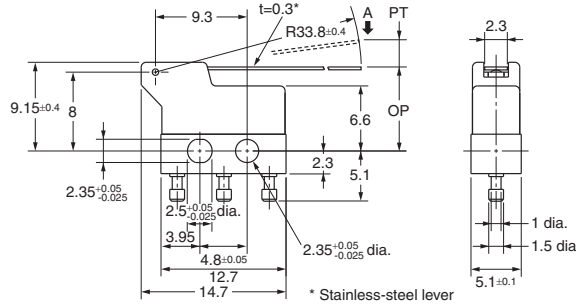
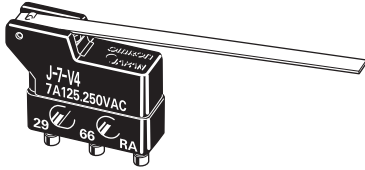

Operating Characteristics	Models		J-7-V4
	OF	Max.	
Operating Force	OF	Max.	0.20 N {20 gf}
Releasing Force	RF	Min.	0.03 N {3 gf}
Pretravel	PT	Max.	4.5 mm
Overtravel	OT	Min.	0.8 mm
Movement Differential	MD	Max.	1.2 mm
Operating Position	OP		8.3±2.9 mm

●Short Hinge Roller Lever
J-7-V22

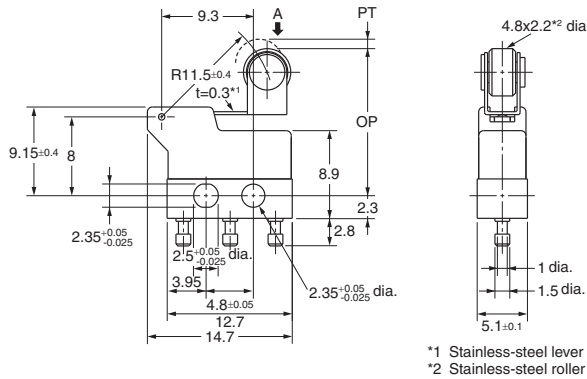
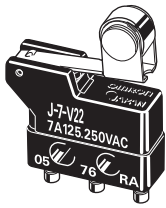

Operating Characteristics	Models		J-7-V22
	OF	Max.	
Operating Force	OF	Max.	0.54 N {55 gf}
Releasing Force	RF	Min.	0.05 N {5 gf}
Pretravel	PT	Max.	1.6 mm
Overtravel	OT	Min.	0.25 mm
Movement Differential	MD	Max.	0.4 mm
Operating Position	OP		14.7±1 mm

●Hinge Roller Lever
J-7-V2

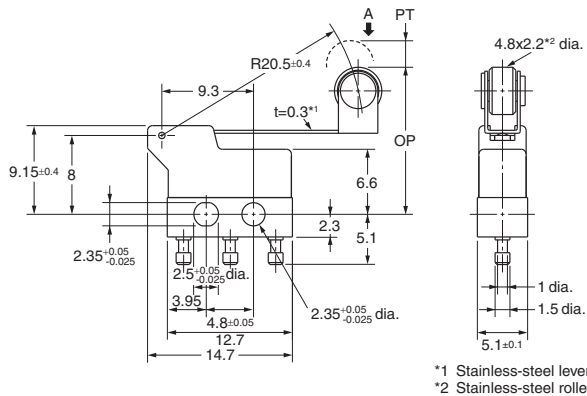
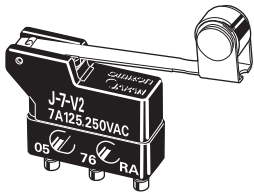

Operating Characteristics	Models		J-7-V2
	OF	Max.	
Operating Force	OF	Max.	0.33 N {33 gf}
Releasing Force	RF	Min.	0.03 N {3 gf}
Pretravel	PT	Max.	2.7 mm
Overtravel	OT	Min.	0.45 mm
Movement Differential	MD	Max.	0.7 mm
Operating Position	OP		14.7±1.9 mm

Note 1. Unless otherwise specified, a tolerance of ±0.2 mm applies to all dimensions.
Note 2. The operating characteristics are for operation in the A direction (↓).

Precautions

★Please refer to "Common Precautions" for correct use.

Caution

●Soldering

- Terminal connection
When soldering, make sure that the temperature of the soldering iron tip is not higher than 280°C, and complete the soldering within 3 seconds. Leave it for 1 minute without applying any external force to the terminal after the soldering. Soldering at an excessively high temperature or soldering for more than 3 s may deteriorate the characteristics of the Switch.

Correct Use

●Mounting

Use M2.3 mounting screw with plane washers or spring washers to securely mount the Switch. Tighten the screws to a torque of 0.2 to 0.29 N·m {2 to 3 kgf·cm}.

- Application examples provided in this document are for reference only. In actual applications, confirm equipment functions and safety before using the product.
- Consult your OMRON representative before using the product under conditions which are not described in the manual or applying the product to nuclear control systems, railroad systems, aviation systems, vehicles, combustion systems, medical equipment, amusement machines, safety equipment, and other systems or equipment that may have a serious influence on lives and property if used improperly. Make sure that the ratings and performance characteristics of the product provide a margin of safety for the system or equipment, and be sure to provide the system or equipment with double safety mechanisms.

Note: Do not use this document to operate the Unit.

Looking for pricing, stock, or lifecycle information?

Click below to explore more details on WIN SOURCE:

 [View J-7-V on WIN SOURCE](#)

 [Omron Information](#)

Optimize Your Supply Chain with WIN SOURCE Solutions

-  Global Sourcing Solution
-  Obsolete Management
-  Cost Control Management
-  Shortage Management
-  Alternative Solution
-  Excess Inventory Management