



THE DATASHEET OF
2983TR



SURFACE MOUNT (SMT) COIN CELL ENCLOSURE CONTACTS



- Contacts for Enclosure cases with self contained battery compartments
- Design facilitates easy battery access, removal & installation
- Suitable for industrial and consumer product applications
- Spring contacts adjust to variations in battery diameter for a dependable connection
- Positive and Negative contacts can be used as a design pair or individually on a PCB
- Accommodates cell diameters from 16mm to 30mm

MATERIAL: .006 (.15) Stainless steel, Gold plate (flash)

AVAILABLE ON TAPE AND REEL

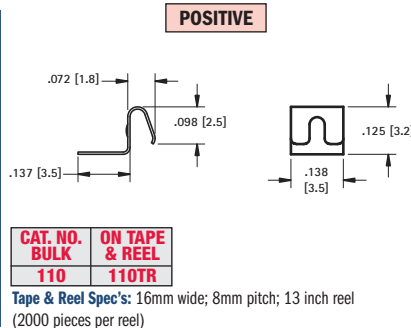
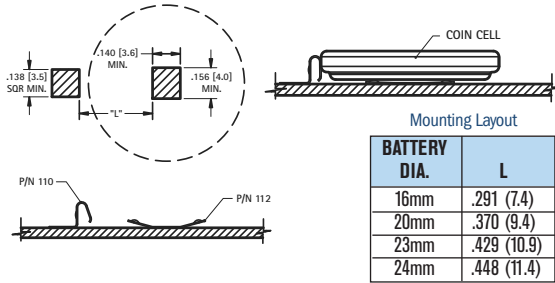

CAT. NO. BULK	ON TAPE & REEL
110	110TR

Tape & Reel Spec's: 16mm wide; 8mm pitch; 13 inch reel (2000 pieces per reel)

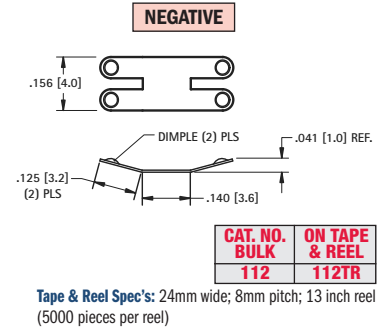

CAT. NO. BULK	ON TAPE & REEL
112	112TR

Tape & Reel Spec's: 24mm wide; 8mm pitch; 13 inch reel (5000 pieces per reel)

THRU-HOLE (THM) & SURFACE MOUNT (SMT) NEGATIVE BATTERY CONTACTS

AVAILABLE ON TAPE AND REEL

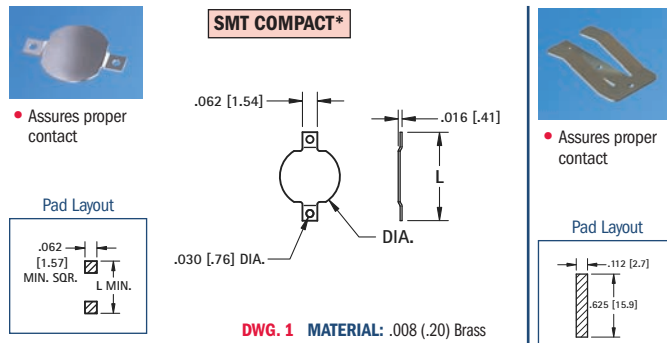

DWG. 1 MATERIAL: .008 (.20) Brass

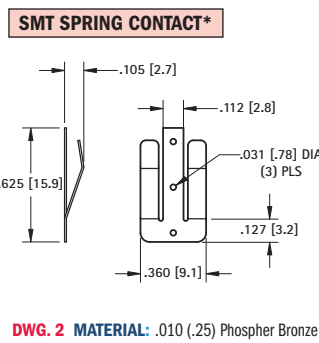

DWG. 2 MATERIAL: .010 (.25) Phosphor Bronze

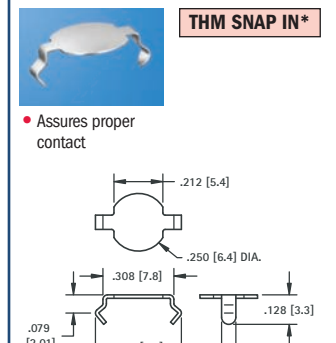

MATERIAL: .008 (.20) Phosphor Bronze, Tin-Nickel Plate
CAT. NO. 2990

TIN-NICKEL PLATE		MATTE TIN PLATE		DWG.	L	DIA.	TAPE & REEL SPECS
CAT. NO. BULK	ON TAPE & REEL	CAT. NO. BULK	ON TAPE & REEL				
2991	2991TR	2981	2981TR	1	.368 (9.4)	.250 (6.4)	16mm wide, 8mm pitch, 1500/7 reel
2992	2992TR	2982	2982TR	1	.289 (7.4)	.186 (4.7)	16mm wide, 12mm pitch, 1000/7 reel
2993	2993TR	2983	2983TR	2	.625 (15.9)	-	24mm wide, 16mm pitch, 1000/13 reel

***Note:** Cannot be used with Cat. No. 3028, 3029, 3032, 3038, 3042, 3026, 3078.

THRU-HOLE (THM) & SURFACE MOUNT (SMT) INSULATED RETAINERS

AVAILABLE ON TAPE AND REEL

20mm CELLS



Surface Mount

- Ideal for 6 volt or 3 volt applications
- Two coin cell batteries can be installed in series
- Plastic insulator prevents shorting of battery, within the holder, when installed improperly

MATERIAL: Contacts: .010 (.25) Phosphor Bronze Insulator: High Temperature, Nylon 46, UL Rated 94V-0

- Low profile
- Battery release ports for easy battery replacement
- Refer to pages 7 & 9 for a complete offering of coin cell retainers



Thru Hole Mount

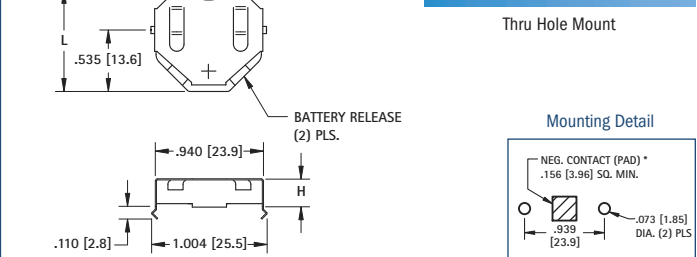
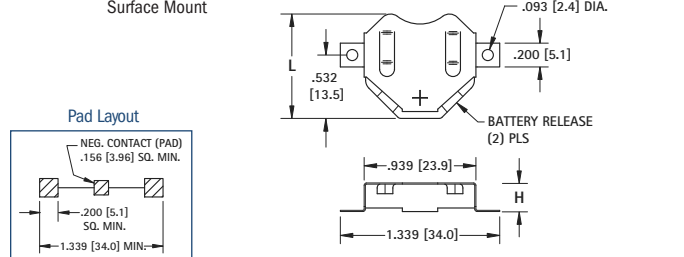

Surface Mount						BATTERY REFERENCE				Thru Hole Mount			
Tin-Nickel Plate			Matte Tin Plate			L	H	6 VOLT (2) CELLS	3 VOLT (1) CELL	L	H	Tin-Nickel Plate	
CAT. NO. LOOSE*	CAT. NO. BULK	ON TAPE & REEL	CAT. NO. LOOSE*	CAT. NO. BULK	ON TAPE & REEL							CAT. NO. LOOSE*	CAT. NO. BULK
3020-2	3020	3020TR	3070-2	3070	3070TR	.890 (22.6)	.156 (4.0)	2012, 2016	2020, 2025	.890 (22.6)	.156 (4.0)	3021-2	3021
3022-2	3022	3022TR	3072-2	3072	3072TR	.877 (22.3)	.240 (6.1)	2020, 2025	2032	.877 (22.3)	.240 (6.1)	3023-2	3023
3024-2	3024	3024TR	3074-2	3074	3074TR	.877 (22.3)	.295 (7.5)	2032	Not Applicable	.877 (22.3)	.295 (7.5)	3025-2	3025

* Supplied Unassembled
Tape & Reel Spec's: 56mm wide; 28mm pitch; 13 inch reel: 3020TR, 3070TR 400 pieces per reel; 3022TR, 3072TR 250 pieces per reel; 3024TR, 3074TR 250 pieces per reel

Looking for pricing, stock, or lifecycle information?

Click below to explore more details on WIN SOURCE:

- ⊖ [View 2983TR](#) on WIN SOURCE
- ⊖ [Keystone Electronics](#) Information

Optimize Your Supply Chain with WIN SOURCE Solutions

- ✓ Global Sourcing Solution
- ✓ Obsolete Management
- ✓ Cost Control Management
- ✓ Shortage Management
- ✓ Alternative Solution
- ✓ Excess Inventory Management