



**THE DATASHEET OF
CP12943_LARISA-O-CLIP16**



LARISA-O-CLIP16

~40° x 20° oval beam. Clip fastening for 1.6 mm thick PCB.

SPECIFICATION:

| | |
|----------------|-----------|
| Dimensions | 9.9 x 9.9 |
| Height | 7.5 mm |
| Fastening | clips |
| ROHS compliant | yes ⓘ |



MATERIALS:

| Component | Type | Material | Colour | Finish | Length (mm) |
|----------------------|-------------|----------|--------|--------|-------------|
| LARISA-O | Single lens | PMMA | clear | | |
| LARISA-HOLDER-CLIP16 | Holder | PC | black | | |

ORDERING INFORMATION:

| Component | | Qty in box | MOQ | MPQ | Box weight (kg) |
|--------------------------------|-------------|------------|-----|-----|-----------------|
| CP12943_LARISA-O-CLIP16 | Single lens | 10000 | 300 | 100 | 6.6 |
| » Box size: 300 x 250 x 250 mm | | | | | |

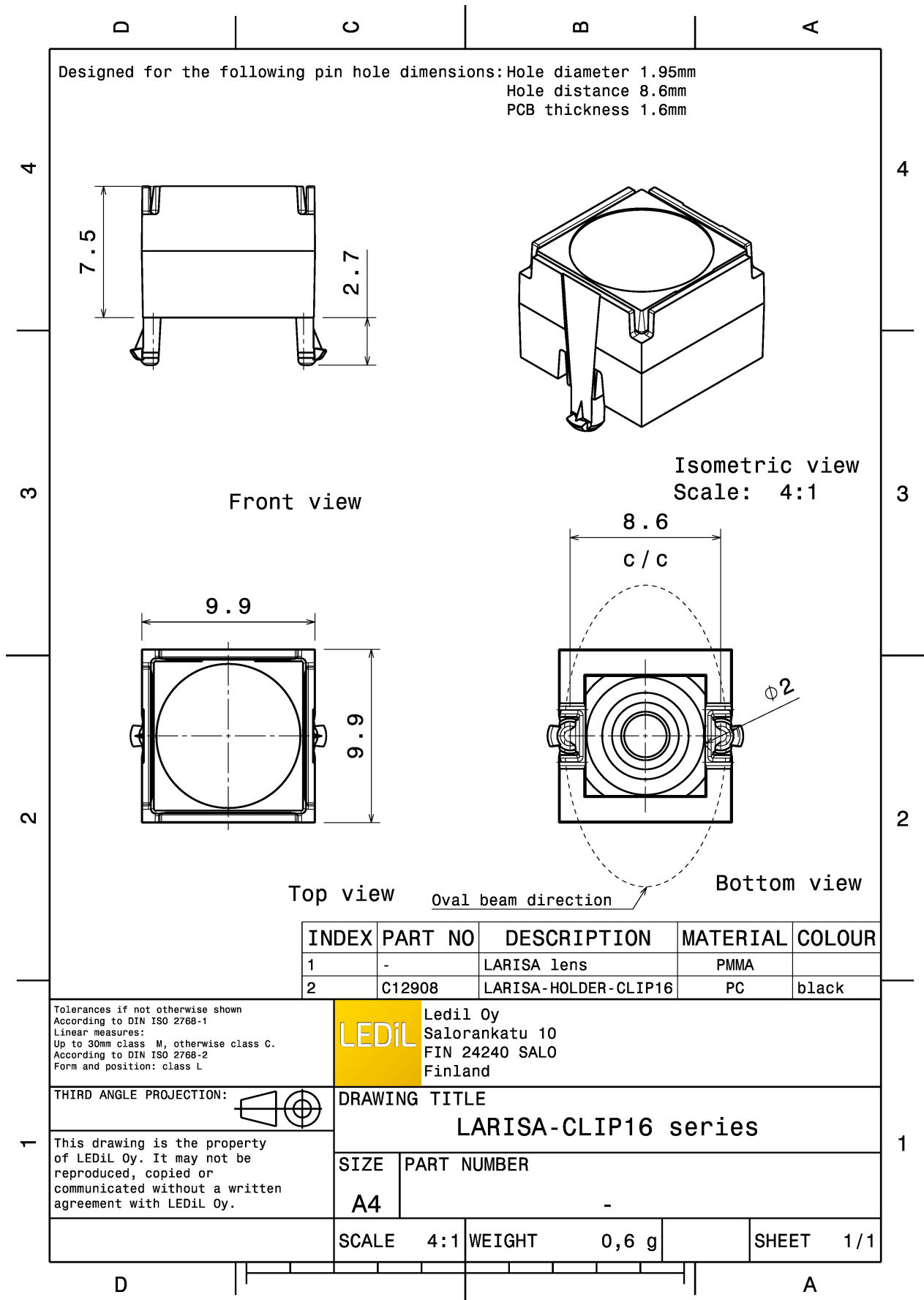

See also our general installation guide: www.ledil.com/installation_guide

OPTICAL RESULTS (MEASURED):



LED XB-D
FWHM / FWTM 39.0 + 21.0° / 73.0 + 49.0°
Efficiency 80 %
Peak intensity 2.2 cd/lm
LEDs/each optic 1
Light colour/type White
Required components:

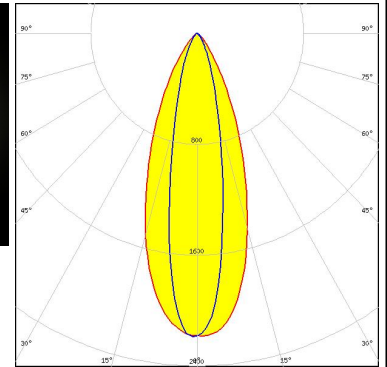

Light distribution files



LED XD16
FWHM / FWTM 40.0 + 20.0° / 72.0 + 51.0°
Efficiency 75 %
Peak intensity 2.1 cd/lm
LEDs/each optic 1
Light colour/type White
Required components:

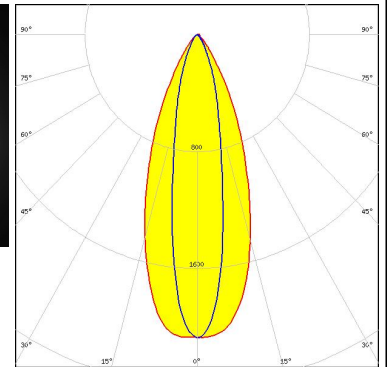
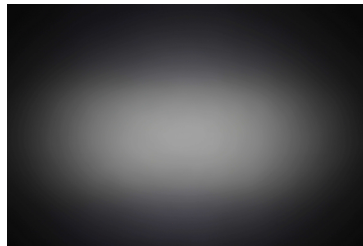

Light distribution files



LED XP-G
FWHM / FWTM 39.0 + 25.0° / 76.0 + 51.0°
Efficiency 83 %
Peak intensity 2.1 cd/lm
LEDs/each optic 1
Light colour/type White
Required components:

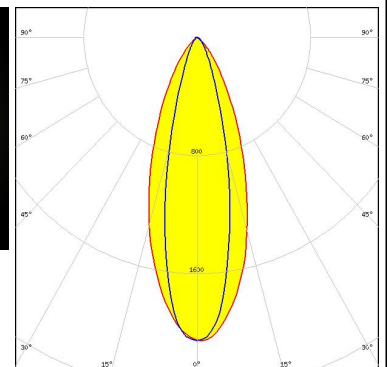
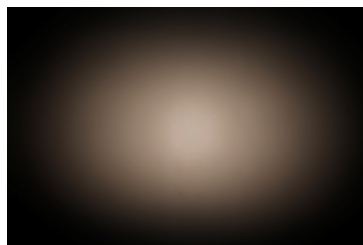

Light distribution files

OPTICAL RESULTS (MEASURED):



LED XQ-E HD
 FWHM / FWTM 40.0 + 17.0° / 68.0 + 42.0°
 Efficiency 82 %
 Peak intensity 2.8 cd/lm
 LEDs/each optic 1
 Light colour/type White
 Required components:

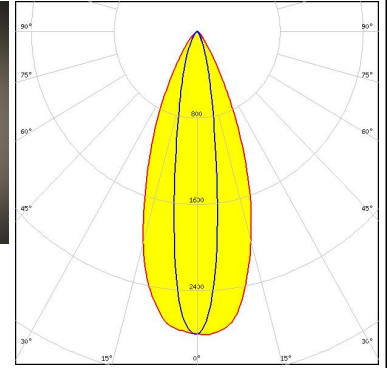
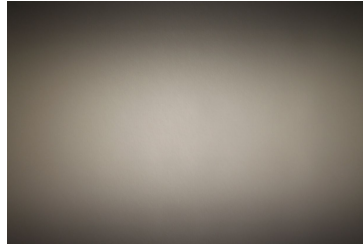

Light distribution files



LED XQ-E HI
 FWHM / FWTM 43.0 + 14.0° / 64.0 + 36.0°
 Efficiency 74 %
 Peak intensity 3.2 cd/lm
 LEDs/each optic 1
 Light colour/type White
 Required components:



Light distribution files



LED LUXEON A
 FWHM / FWTM 39.0 + 26.0° / 78.0 + 55.0°
 Efficiency 81 %
 Peak intensity 1.9 cd/lm
 LEDs/each optic 1
 Light colour/type White
 Required components:

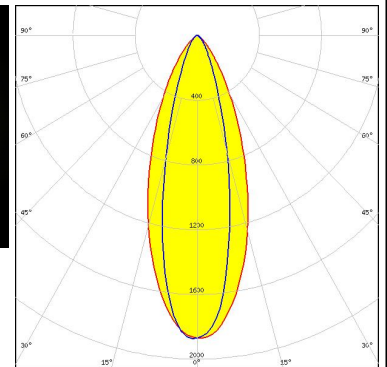
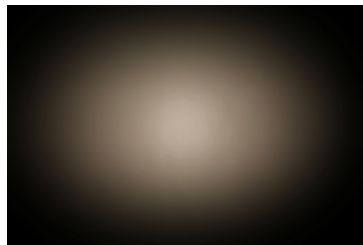

Light distribution files

OPTICAL RESULTS (MEASURED):



LED LUXEON C
FWHM / FWTM 40.0 + 18.0° / 69.0 + 43.0°
Efficiency 79 %
Peak intensity 2.6 cd/lm
LEDs/each optic 1
Light colour/type White
Required components:

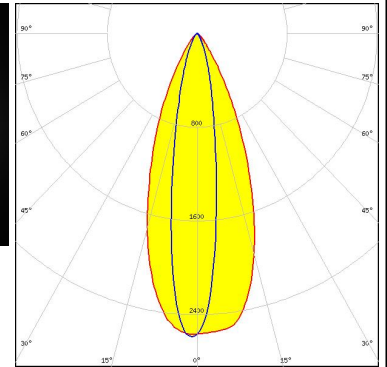
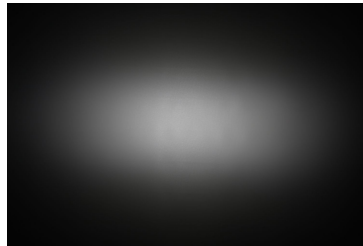

Light distribution files



LED LUXEON Rebel
FWHM / FWTM 40.0 + 18.0° / 70.0 + 42.0°
Efficiency 84 %
Peak intensity 2.7 cd/lm
LEDs/each optic 1
Light colour/type White
Required components:

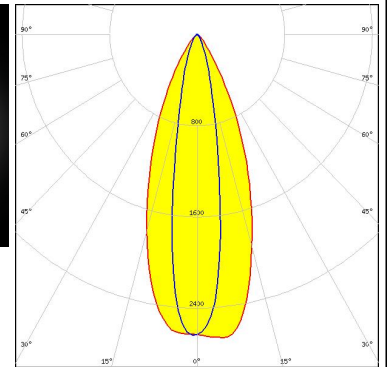

Light distribution files



LED LUXEON Rebel ES
FWHM / FWTM 39.0 + 25.0° / 77.0 + 54.0°
Efficiency 82 %
Peak intensity 1.9 cd/lm
LEDs/each optic 1
Light colour/type White
Required components:

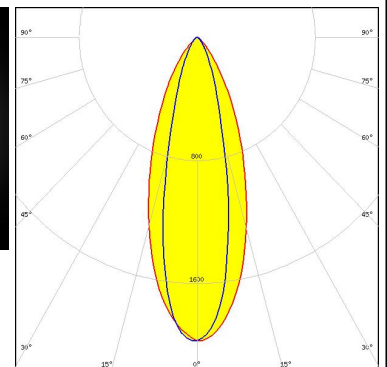
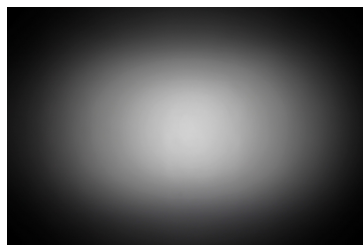

Light distribution files

OPTICAL RESULTS (MEASURED):



LED LUXEON Rebel Plus
FWHM / FWTM 40.0 + 19.0° / 69.0 + 46.0°
Efficiency 83 %
Peak intensity 2.6 cd/lm
LEDs/each optic 1
Light colour/type White
Required components:

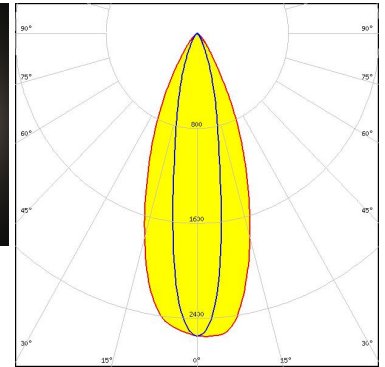
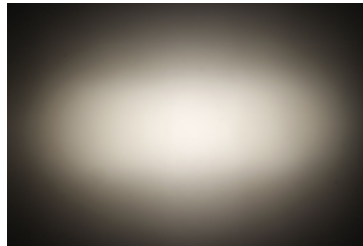

Light distribution files



LED LUXEON Z
FWHM / FWTM 41.0 + 14.0° / 62.0 + 360.0°
Efficiency 81 %
Peak intensity 3.5 cd/lm
LEDs/each optic 1
Light colour/type White
Required components:



Light distribution files



LED LUXEON Z ES
FWHM / FWTM 40.0 + 18.0° / 68.0 + 44.0°
Efficiency 86 %
Peak intensity 2.8 cd/lm
LEDs/each optic 1
Light colour/type White
Required components:

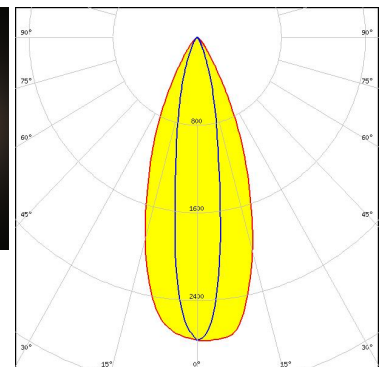
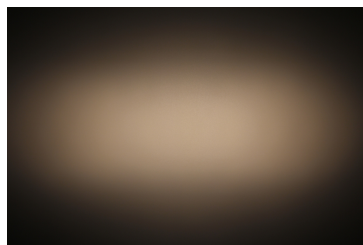

Light distribution files

OPTICAL RESULTS (MEASURED):



LED NCSxx19A
 FWHM / FWTM 41.0 + 19.0° / 71.0 + 50.0°
 Efficiency 81 %
 Peak intensity 2.3 cd/lm
 LEDs/each optic 1
 Light colour/type White
 Required components:

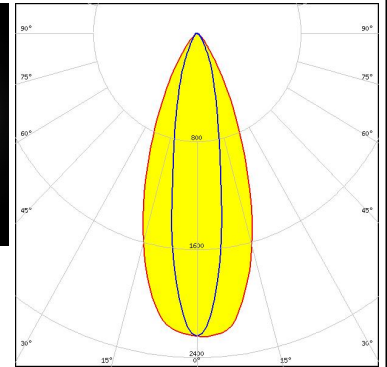

Light distribution files



LED NVSxx19A
 FWHM / FWTM 40.0 + 24.0° / 77.0 + 57.0°
 Efficiency 79 %
 Peak intensity 1.9 cd/lm
 LEDs/each optic 1
 Light colour/type White
 Required components:

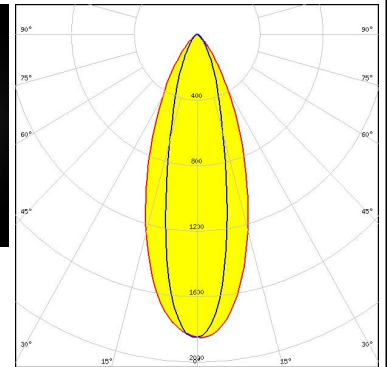

Light distribution files



LED Duris S5 (2 chip)
 FWHM / FWTM 26.0 + 41.0° / 63.0 + 77.0°
 Efficiency 79 %
 Peak intensity 1.8 cd/lm
 LEDs/each optic 1
 Light colour/type White
 Required components:

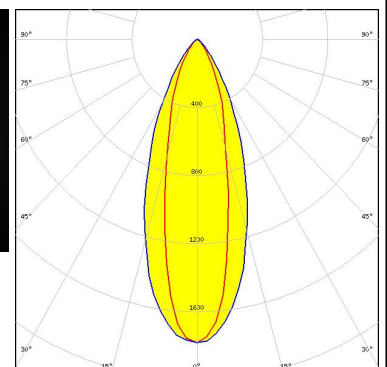
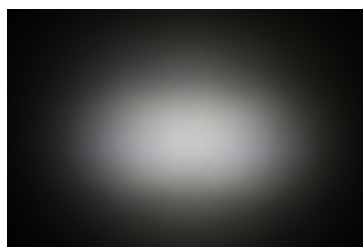

Light distribution files

OPTICAL RESULTS (MEASURED):

OSRAM
Opto Semiconductors

LED OSLON SSL 150
FWHM / FWTM 39.0 + 19.0° / 70.0 + 40.0°
Efficiency 84 %
Peak intensity 2.9 cd/lm
LEDs/each optic 1
Light colour/type White
Required components:

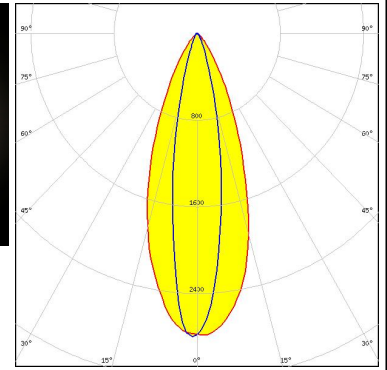

Light distribution files

OSRAM
Opto Semiconductors

LED OSLON SSL 80
FWHM / FWTM 40.0 + 17.0° / 70.0 + 48.0°
Efficiency 77 %
Peak intensity 2.5 cd/lm
LEDs/each optic 1
Light colour/type White
Required components:

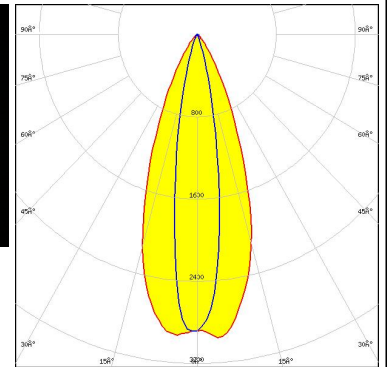
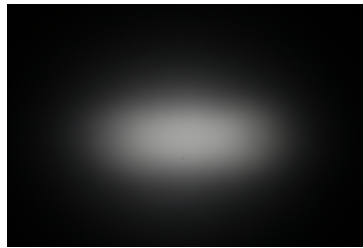

Light distribution files

OPTICAL RESULTS (SIMULATED):



LED XP-E
FWHM / FWTM 39.0 + 17.0°
Efficiency 89 %
LEDs/each optic 1
Light colour/type White
Required components:

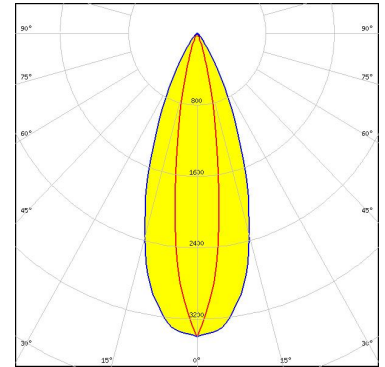

Light distribution files



LED LUXEON Z
FWHM / FWTM 40.0 + 14.0° / 62.0 + 28.0°
Efficiency 88 %
Peak intensity 4.3 cd/lm
LEDs/each optic 1
Light colour/type White
Required components:

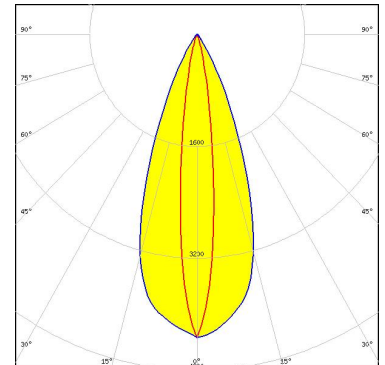

Light distribution files



LED OSOLON Pure 1414
FWHM / FWTM 16.0 + 40.0° / 30.0 + 64.0°
Efficiency 90 %
Peak intensity 4.1 cd/lm
LEDs/each optic 1
Light colour/type White
Required components:

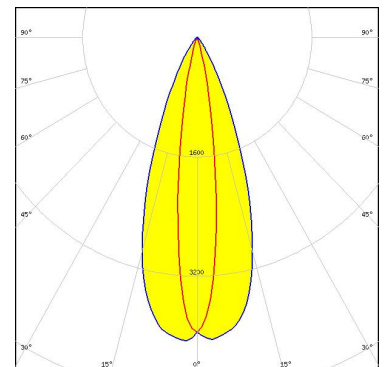

Light distribution files

GENERAL INFORMATION:

NOTE: The typical beam angle will be changed by different color, chip size and chip position tolerance. The typical total beam angle is the full angle measured where the luminous intensity is half of the peak value.

MATERIALS:

As part of our continuous research and improvement processes, and to ensure the best possible quality and availability of our products, LEDiL reserves the right to change material grades without notice.

PRODUCT DATA USER AGREEMENT AND DISCLAIMER:

The measured data in the provided downloadable LEDiL Product Datasheets and Mechanical 2D-Drawings is rounded and provided as reference for planning. LEDiL Oy's optical specifications have been verified by conducting performance testing of the products in accordance with the company's quality system. The reported data are averaged results of multiple measurements with typical variation. LEDiL Oy reserves the right to without prior notification make changes and improvements to its products.

LEDiL Oy assumes neither warranty, nor guarantee nor any other liability of any kind for the contents and correctness of the provided data. The provided data has been generated with highest diligence but the provided data may in reality not represent the complete possible variation range of all intrinsic parameters. Therefore, in certain cases a deviation from the provided data could occur.

LEDiL Oy reserves the right to undertake technical changes of its products without further notification which could lead to changes in the provided data. LEDiL Oy assumes no liability of any kind for the possible deviation from any provided data or any other damage resulting from the usage of the provided data.

The user agrees to this disclaimer and user agreement with the download or usage of the provided files.

LEDiL Oy

Joensuunkatu 7
FI-24240 SALO
Finland

LEDiL Inc.

228 West Page Street
Suite D
Sycamore IL 60178
USA

Ledil Optics Technology (Shenzhen) Co., Ltd.

405 , Block B
Casic Motor Building
Shenzhen 518057
P.R.CHINA

Local sales and technical support

[www.ledil.com/
where_to_buy](http://www.ledil.com/where_to_buy)

Shipping locations

Poznan, Poland
Hong Kong, China

Distribution Partners

[www.ledil.com/
where_to_buy](http://www.ledil.com/where_to_buy)

Looking for pricing, stock, or lifecycle information?

Click below to explore more details on WIN SOURCE:

 [View CP12943_LARISA-O-CLIP16 on WIN SOURCE](#)

 [Ledil Information](#)

Optimize Your Supply Chain with WIN SOURCE Solutions

-  Global Sourcing Solution
-  Obsolete Management
-  Cost Control Management
-  Shortage Management
-  Alternative Solution
-  Excess Inventory Management