



**THE DATASHEET OF  
GSF2.2011.01**



IEC Appliance Inlet C14 with Fuseholder 1- or 2-pole



Snap-in version



See below:  
[Approvals and Compliances](#)

**Description**

- Panel mount :  
 Snap-in version front side
- 2 Functions :  
 Appliance Inlet protection class I or II , Fuseholder for fuse-links 5 x 20 mm on the rear-side 1- or 2-pole
- Meets the requirements of IEC 60335-1 for appliances in unattended use. This includes the enhanced requirements of glow wire tests acc. to IEC 60695-2-11 or -12 &-13.

**Characteristics**

- Two "locking" snappers reinforce connector against repeated or excessive pull out force during plug removal
- All single elements are already wired
- Fuseholder on the inside of the equipment prevents accidental use of incorrect fuse-links by the user
- Suitable for use in equipment according to IEC/UL 62368-1

**Other versions on request**

- Ground terminal, solder/quick-connect, 90° to connector axis

**Weblinks**

[pdf data sheet](#), [html datasheet](#), [General Product Information](#), [Approvals](#), [Distributor-Stock-Check](#), [Accessories](#), [Detailed request for product](#)

**Technical Data**

Ratings IEC	10A / 250VAC; 50Hz
Ratings UL/CSA	10A / 125VAC; 60Hz
Dielectric Strength	> 2.2kVAC between L-N > 3kVAC between L/N-PE (1 min/50Hz)
Allowable Operation Temperature	-25°C to 70°C
IP-Protection	front side IP40 acc. to IEC 60529
Protection against electric shock	Suitable for appliances with protection class I or II acc. to IEC 61140
Terminal	Quick connect terminals 4.8 x 0.8 mm , Ground terminal: Solder / Quick Connect tin-plated Solder terminal on request
Panel Thickness S	Snap-in: 1/1.2/1.5/2/2.5/3 mm (other on request) (all steps with one variant)
Material: Housing	Thermoplastic, black, UL 94V-0

Appliance inlet/-outlet	C14 / C18 acc. to IEC 60320-1, UL 498, CSA C22.2 no. 42 (for cold conditions) pin-temperature 70 °C, 10A, Protection Class I or II
Fuseholder	1-/2-pole, Shocksafe category PC2 acc. to IEC 60127-6, for fuse-links 5 x 20mm
Rated Power Acceptance @ Ta 23 °C	5 x 20: 3.15W (1 pole)/ 2.5W (2-pole) per pole
Power Acceptance @ Ta > 23°C	Admissible power acceptance at higher ambient temperature see derating curves

**Approvals and Compliances**



Detailed information on product approvals, code requirements, usage instructions and detailed test conditions can be looked up in [Details about Approvals](#)

SCHURTER products are designed for use in industrial environments. They have approvals from independent testing bodies according to national and international standards. Products with specific characteristics and requirements such as required in the automotive sector according to IATF 16949, medical technology according to ISO 13485 or in the aerospace industry can be offered exclusively with customer-specific, individual agreements by SCHURTER.

## Approvals





The approval mark is used by the testing authorities to certify compliance with the safety requirements placed on electronic products.

Approval Reference Type: GSF2

Approval Logo	Certificates	Certification Body	Description
	<a href="#">VDE Approvals</a>	VDE	Certificate Number: 40024857
	<a href="#">UL Approvals</a>	UL	UR File Number: E93617, E96454
	<a href="#">CCC Approvals</a>	CCC	CCC Certificate Number: 2006010204183182



## Product standards

Product standards that are referenced

Organization	Design	Standard	Description
	Designed according to	IEC 60320-1	Appliance couplers for household and similar general purposes
	Designed according to	IEC 60127-6	Miniature fuses. Part 6. Fuse-holders for miniature fuse-links
	Designed according to	IEC 61058-1	Switches for appliances. Part 1. General requirements
	Designed according to	UL 498	Standard for Attachment Plugs and Receptacles
	Designed according to	CSA C22.2 no. 42	General Use Receptacles, Attachment Plugs, and Similar Wiring Devices







## Application standards

Application standards where the product can be used

Organization	Design	Standard	Description
	Suitable for applications acc.	IEC/UL 62368-1	Audio/video, information and communication technology equipment - Part 1: Safety requirements
	Suitable for applications acc.	IEC 60335-1	Safety of electrical appliances for household and similar purposes. Meets the requirements for appliances in unattended use. This includes the enhanced requirements of glow wire tests acc. to IEC 60695-2-11 or -12 & -13.

## Compliances

The product complies with following Guide Lines

Identification	Details	Initiator	Description
	<a href="#">CE declaration of conformity</a>	SCHURTER AG	The CE marking declares that the product complies with the applicable requirements laid down in the harmonisation of Community legislation on its affixing in accordance with EU Regulation 765/2008.
	<a href="#">UKCA declaration of conformity</a>	SCHURTER AG	The UKCA marking declares that the product complies with the applicable requirements laid down in the British Amendment of Regulation (EC) 765/2008.
	RoHS	SCHURTER AG	Directive RoHS 2011/65/EU, Amendment (EU) 2015/863
	China RoHS	SCHURTER AG	The law SJ / T 11363-2006 (China RoHS) has been in force since 1 March 2007. It is similar to the EU directive RoHS.
	REACH	SCHURTER AG	On 1 June 2007, Regulation (EC) No 1907/2006 on the Registration, Evaluation, Authorization and Restriction of Chemicals 1 (abbreviated as "REACH") entered into force.
	White Paper Glow wire test	SCHURTER AG	Meets the requirements of IEC 60335-1 for appliances in unattended use. This includes the enhanced requirements of glow wire tests acc. to IEC 60695-2-11 or -12 & -13.

Dimensions [mm]

punched / drilled

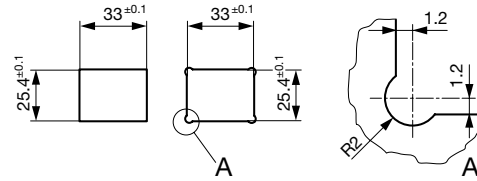
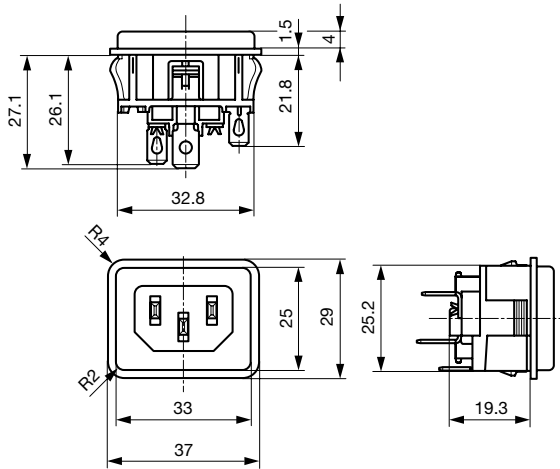

Line and neutral: Quick-connect  
 Quick connect terminal 4.8 x 0.8  
 mm

Ground terminal  
 Quick connect terminal 4.8 x 0.8  
 mm

Ground terminal: Quick-connect  
 Quick connect terminal 6.3 x 0.8  
 mm

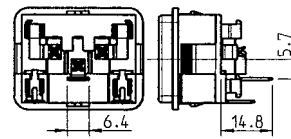
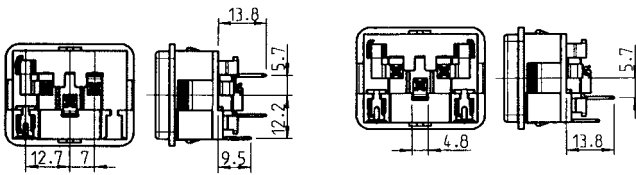

Assembly Instructions

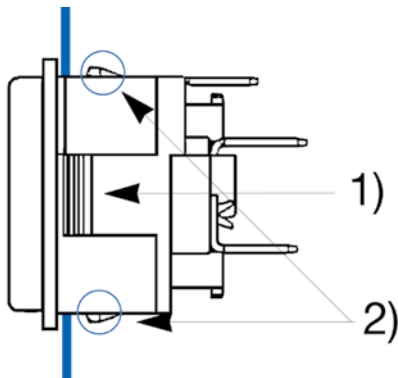

- 1) Main snappers for snap-in mounting
- 2) Additional safety snappers not in use

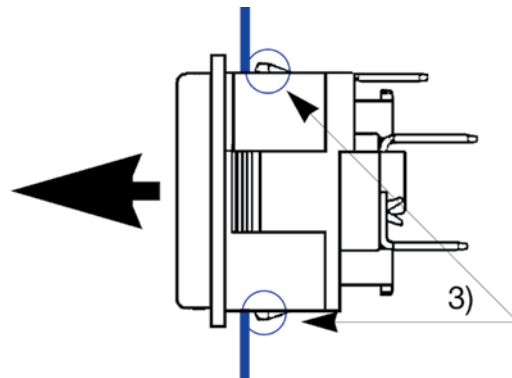

- 3) Additional safety snappers in use  
 against excessive pull out force

Derating Curves

1-pole

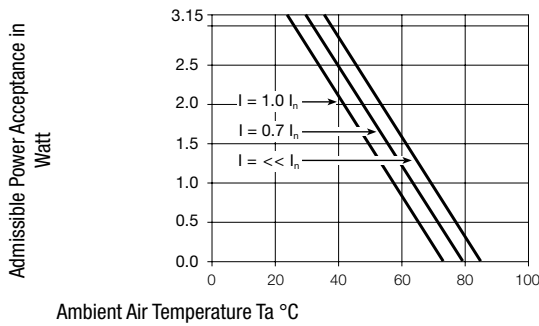

2-pole

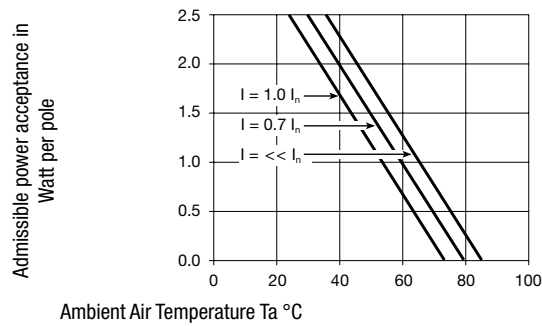

Variants

Protection Class	Fuseholder	Terminals L / N		Ground terminal		Order Number
		Connection type	Terminal direction	Connection type	Terminal direction	
I	-	Quick connect terminals 4.8 x 0.8 mm	in line with PIN-axis	Quick connect terminals 4.8 x 0.8 mm	in line with PIN-axis	GSF2.0011.01
I	1-pole	Quick connect terminals 4.8 x 0.8 mm	in line with PIN-axis	Quick connect terminals 4.8 x 0.8 mm	in line with PIN-axis	GSF2.1011.01
I	1-pole	Quick connect terminals 4.8 x 0.8 mm	in line with PIN-axis	Quick connect terminals 6.3 x 0.8 mm	in line with PIN-axis	GSF2.1013.01
I	1-pole	Quick connect terminals 4.8 x 0.8 mm	90° to connector axis	Quick connect terminals 4.8 x 0.8 mm	90° to connector axis	GSF2.1022.01
I	2-pole	Quick connect terminals 4.8 x 0.8 mm	in line with PIN-axis	Quick connect terminals 4.8 x 0.8 mm	in line with PIN-axis	GSF2.2011.01
I	2-pole	Quick connect terminals 4.8 x 0.8 mm	in line with PIN-axis	Quick connect terminals 6.3 x 0.8 mm	in line with PIN-axis	GSF2.2013.01
I	2-pole	Quick connect terminals 4.8 x 0.8 mm	90° to connector axis	Quick connect terminals 4.8 x 0.8 mm	90° to connector axis	GSF2.2022.01
II	1-pole	Quick connect terminals 4.8 x 0.8 mm	in line with PIN-axis	-	-	GSF2.1010.01
II	2-pole	Quick connect terminals 4.8 x 0.8 mm	in line with PIN-axis	-	-	GSF2.2010.01

Availability for all products can be searched real-time: <https://www.schurter.com/en/info-center/support-tools/stock-check-distributors>

Packaging unit

50 Pcs

Mating Outlets/Connectors

Category / Description

[Connector Overview complete](#)



4782 Mounting: Power Cord, 3 x 1 mm <sup>2</sup> / 3 x 18 AWG, Cable, Connector: IEC C13	4782
4785 Mounting: Power Cord, 3 x 1 mm <sup>2</sup> / 3 x 18 AWG, Cable, Connector: IEC C13	4785
4300-06 Mounting: Power Cord, 3 x 1 mm <sup>2</sup> / 3 x 18 AWG, Cable, Connector: IEC C13	4300-06
4781 Mounting: Power Cord, Cable, Connector: IEC C15	4781
4784 Mounting: Power Cord, 3 x 1 mm <sup>2</sup> / 3 x 18 AWG, Cable, Connector: IEC C15	4784

[Interconnection Cord Overview complete](#)



Cord Sets 10 A, Interconnection, 2.0 m, IEC H05VV-F3G1.0, black	6007.0204
Cord Sets 10 A, Interconnection, 1.0 m, Connector IEC C13, H05VV-F3G1.0, black	6007.0212
Cord Sets 10 A, Interconnection, 2.0 m, Connector IEC C13, H05VV-F3G1.0, black	6007.0214

Category / Description

Power Supply Cord Overview complete



Cord Sets 10 A, Europlug, 2.5 m, Connector IEC C13, H05VV-F3G1.0, black	6004.0215
Cord Sets 10 A, Europlug, 2.5 m, Connector IEC C13, H05VV-F3G1.0, black	6003.0215
Cord Sets 10 A, uninsulated wires, 2.0 m, Connector IEC C13, H05VV-F3G1.0, black	6000.0224
Cord Sets 10 A, uninsulated wires, 2.0 m, Connector IEC C13, H05VV-F3G1.0, black	6000.0214
Cord Sets 10 A, United Kingdom, 2.5 m, Connector IEC C13, H05VV-F3G1.0, black	6044.0215

...

Power Supply or Interconnection Cord Overview complete



Cord Sets 10 A, United Kingdom, 2.0 m, Connector IEC H05VV-F3G1.0, black	6044.0204
--	-----------

## Looking for pricing, stock, or lifecycle information?

Click below to explore more details on WIN SOURCE:

 [View GSF2.2011.01 on WIN SOURCE](#)

 [Schurter Inc. Information](#)

## Optimize Your Supply Chain with WIN SOURCE Solutions

-  Global Sourcing Solution
-  Obsolete Management
-  Cost Control Management
-  Shortage Management
-  Alternative Solution
-  Excess Inventory Management