



**THE DATASHEET OF
SKHHQNA010**



SKHH 6mm Square (Snap-in Type)

User friendly 6.0×6.0mm type, available in a wide variety

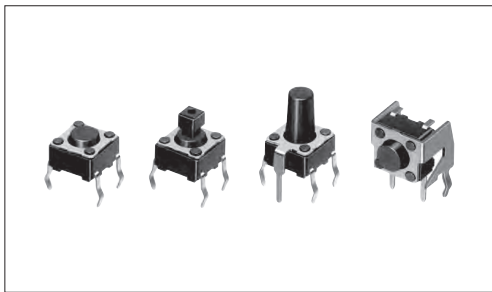

Typical Specifications

Items	Specifications
Rating (max.)	50mA 12V DC
Rating (min.)	10μA 1V DC
Initial contact resistance	100mΩ max.
Travel (mm)	0.25

Product Line

Top push type

Product No.	Operating force	Operating direction	Operating life (5mA 5V DC)	Stem color	Height	Minimum order unit (pcs.)		Drawing No.
						Japan	Export	
SKHHAJA010	0.98N	Top push	1,000,000 cycles	Black	h=4.3mm	1,000	1,000	1
SKHHALA010	1.57N		500,000 cycles	Dark gray				
SKHHQA010	2.55N		200,000 cycles	Red				
SKHHAKA010	0.98N		1,000,000 cycles	Black	h=5mm			
SKHHAMA010	1.57N		500,000 cycles	Dark gray				
SKHHARA010	2.55N		200,000 cycles	Red				
SKHHCQA010	3.53N			Orange				
SKHHCRA010	5.10N			Yellow				
SKHHBVA010	0.98N		1,000,000 cycles	Black	h=7mm			
SKHHBWA010	1.57N		500,000 cycles	Dark gray				
SKHHBYA010	2.55N		200,000 cycles	Red				
SKHHANA010	0.98N		1,000,000 cycles	Black	h=9.5mm			
SKHHAPA010	1.57N		500,000 cycles	Dark gray				
SKHHBSA010	2.55N		200,000 cycles	Red				
SKHHDTA010	0.98N		1,000,000 cycles	Black	h=13mm			
SKHHDUA010	1.57N		500,000 cycles	Dark gray				
SKHHDHA010	0.98N			300,000 cycles	Black			
SKHHDJA010	1.57N		300,000 cycles	Dark gray				

Joint stem type

Product No.	Operating force	Operating direction	Operating life (5mA 5V DC)	Stem color	Height	Minimum order unit (pcs.)		Drawing No.
						Japan	Export	
SKHHCWA010	0.98N	Top push	1,000,000 cycles	Black	h=7.3mm	1,000	1,000	2
SKHHDAA010	1.57N		500,000 cycles	Dark gray				
SKHHDGA010	2.55N		200,000 cycles	Red				

Refer to P.235 for soldering conditions.

SKHH 6mm Square (Snap-in Type)

TACT Switch™

Sharp Feeling

Soft Feeling

Snap-in Type

Surface Mount Type

Radial Type

Product Line

With ground terminal type

Product No.	Operating force	Operating direction	Operating life (5mA 5V DC)	Stem color	Height	Minimum order unit (pcs.)		Drawing No.
						Japan	Export	
SKHHPJA010	0.98N	Top push	1,000,000 cycles	Black	h=4.3mm	1,000	1,000	3
SKHHPLA010	1.57N		500,000 cycles	Dark gray				
SKHHPQA010	2.55N		200,000 cycles	Red				
SKHHPKA010	0.98N		1,000,000 cycles	Black	h=5mm			
SKHHPMA010	1.57N		500,000 cycles	Dark gray				
SKHHPRA010	2.55N		200,000 cycles	Red				
SKHHQVA010	0.98N		1,000,000 cycles	Black	h=7mm			
SKHHQWA010	1.57N		500,000 cycles	Dark gray				
SKHHQYA010	2.55N		200,000 cycles	Red				
SKHHPNA010	0.98N		1,000,000 cycles	Black	h=9.5mm			
SKHHPPA010	1.57N		500,000 cycles	Dark gray				
SKHHQNA010	2.55N		200,000 cycles	Red				

Side push type

Product No.	Operating force	Operating direction	Operating life (5mA 5V DC)	Stem color	Stem length	Minimum order unit (pcs.)		Drawing No.
						Japan	Export	
SKHHLMA010	0.98N	Side push	1,000,000 cycles	Black	ℓ=3.85mm	1,000	1,000	4
SKHHLNA010	1.57N		500,000 cycles	Dark gray				
SKHHLPA010	2.55N		200,000 cycles	Red				
SKHHLQA010	0.98N		1,000,000 cycles	Black	ℓ=8.35mm			
SKHHLRA010	1.57N		500,000 cycles	Dark gray				
SKHHLSA010	2.55N		200,000 cycles	Red				
SKHHLUA010	0.98N		1,000,000 cycles	Black	ℓ=5.85mm			
SKHHLVA010	1.57N		500,000 cycles	Dark gray				
SKHHLWA010	2.55N		200,000 cycles	Red				
SKHHNHA010	0.98N		500,000 cycles	Black	ℓ=15.85mm			
SKHHNJA010	1.57N		300,000 cycles	Dark gray				
SKHHNKA010	2.55N		200,000 cycles	Red				

Packing Specifications

Bulk

Product No.	Number of packages (pcs.)		Export package measurements (mm)
	1 case /Japan	1 case /export packing	
Other	10,000	30,000	309×476×347
SKHHDT, SKHHDU SKHHDH, SKHHDJ SKHHNH, SKHHNJ SKHHNK	5,000	15,000	

Dimensions

Unit:mm

No.	Photo	Style	PC board mounting hole dimensions (Viewed from switch mounting face)														
1		<table border="1"> <thead> <tr> <th>h</th> <th>A</th> </tr> </thead> <tbody> <tr> <td>4.3</td> <td>3.5</td> </tr> <tr> <td>5</td> <td>3.5</td> </tr> <tr> <td>7</td> <td>3.3</td> </tr> <tr> <td>9.5</td> <td>3</td> </tr> <tr> <td>13</td> <td>3</td> </tr> <tr> <td>17</td> <td>3</td> </tr> </tbody> </table>	h	A	4.3	3.5	5	3.5	7	3.3	9.5	3	13	3	17	3	
h	A																
4.3	3.5																
5	3.5																
7	3.3																
9.5	3																
13	3																
17	3																
2																	
3		<table border="1"> <thead> <tr> <th>h</th> <th>A</th> </tr> </thead> <tbody> <tr> <td>4.3</td> <td>3.5</td> </tr> <tr> <td>5</td> <td>3.5</td> </tr> <tr> <td>7</td> <td>3.3</td> </tr> <tr> <td>9.5</td> <td>3</td> </tr> </tbody> </table>	h	A	4.3	3.5	5	3.5	7	3.3	9.5	3					
h	A																
4.3	3.5																
5	3.5																
7	3.3																
9.5	3																

Sharp Feeling

Soft Feeling

Snap-in Type

Surface Mount Type

Radial Type

SKHH 6mm Square (Snap-in Type)

TACT Switch™

Sharp Feeling

Soft Feeling

Snap-in Type

Surface Mount Type

Radial Type

■ Dimensions

Unit:mm

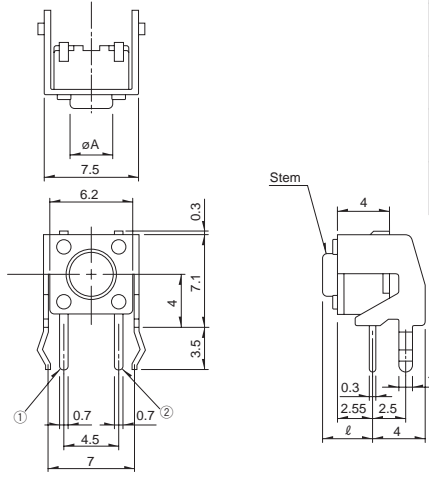
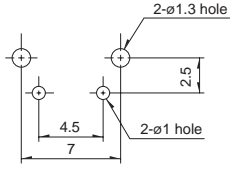
No.	Photo	Style	PC board mounting hole dimensions (Viewed from switch mounting face)	
4			<i>ℓ</i>	A
			3.85	3.5
			5.85	3.3
			8.35	3
			15.85	3
				

Note

Please use 1.6mm thick PC boards.

■ Circuit Diagram

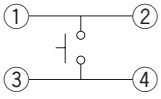
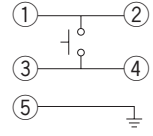
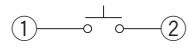
<p>Top push type / Joint stem type</p> 	<p>With ground terminal type</p> 	<p>Side push type</p> 
--	--	---

■ Height with Keytop

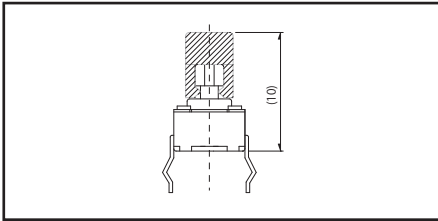

■ Keytop Lineup

Unit:mm

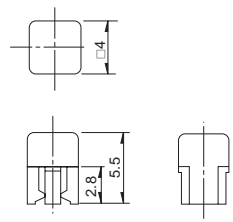
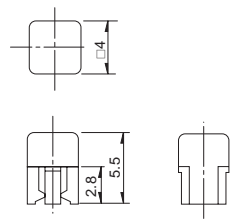
Applicable model	Dimensions	Variety	
		Color	Model
<p>SKHH</p> <p>Applicable to joint stem type</p>	 	<p>Red Blue Ivory Black Yellow</p>	<p>SK2AA00410 SK2AA00420 SK2AA00430 SK2AA00440 SK2AA00450</p>

Note

Keytops are not attached to switches on delivery.

TACT Switch™

List of Varieties

TACT Switch™















Sharp Feeling

Soft Feeling

Snap-in Type

Surface Mount Type

Radial Type











Type		Sharp Feeling Type						
		Snap-in						
Series		SKHL	SKHH	SKHW	SKQJ	SKQB	SKQE	SKHC
Photo								
Features		—	—	—	—	—	Long-life	—
Water-proof		—	—	—	—	●	—	—
Dustproof		—	—	●	●	●	●	—
IP standard		—	—	—	—	—	—	—
Operating direction	Top push	●	●	●	●	●	●	●
	Side push	—	—	—	—	—	—	—
Dimensions (mm)	W	6	□6		□6.6	□10	□12	
	D	3.5						
	H	4.3/5	See the relevant pages for respective product descriptions		4.3/5	5	5/13/23.2	See the relevant pages for respective product descriptions
Operation force coverage	1N max.	↕	↕	↕	↕	↕	↕	↕
	1N to 2N							
	2N to 3N							
	3N to 4N							
	4N to 5N							
Travel (mm)		0.25		0.3	0.25	0.3		
Ground terminal		—	○	—	—	—	—	—
Operating temperature range		-40°C to +90°C			-20°C to +70°C	-40°C to +90°C		-40°C to +85°C
Automotive use		●	●	—	—	●	—	—
Life Cycle								
Electrical performance	Rating (max.) (Resistive load)	50mA 12V DC						
	Rating (min.) (Resistive load)	10μA 1V DC						
	Insulation resistance	100MΩ min. 100V DC 1min.						
	Voltage proof	250V AC 1min.						
Durability	Vibration	10 to 55 to 10Hz/min., the amplitude is 1.5mm for all the frequencies, in the 3 direction of X, Y and Z for 2 hours respectively						
	Lifetime	Shall be in accordance with individual specifications.						
Environmental performance	Cold	-40°C 96h			-30°C 96h	-40°C 96h		
	Dry heat	90°C 96h			80°C 96h	90°C 96h		
	Damp heat	60°C, 90 to 95%RH 96h				60°C, 90 to 95%RH 1,000h	60°C, 90 to 95%RH 96h	
Page		173	175	179	180	182	184	186

W : Width. The most outer dimension excluding terminal portion.
 D : Depth. The most outer dimension excluding terminal portion.
 H : Height. The minimum dimension if there are variances.

TACT Switch™ Soldering Conditions 235
 TACT Switch™ Cautions 236

Notes

- The automotive operating temperature range to be individually discussed upon request.
- Indicates applicability to all products in the series, while ○ indicates applicability to some products in the series.

Type		Sharp Feeling Type				
		Snap-in				Radial
Series		SKHL	SKHH	SKQJ	SKQB	SKRC
Photo						
Features		—	—	—	—	Round terminal type
Water-proof		—	—	—	●	●
Dustproof		—	—	●	●	●
IP standard		—	—	—	—	—
Operating direction	Top push	—	—	—	—	●
	Side push	●	●	●	●	—
Dimensions (mm)	W	7.3	7.5	7.5	11.5	φ9
	D	7.22	7.85	7.85	11.9	
	H	4.3	7.4	7.3	11.3	
Operation force coverage	1N max.	↕	↕	↕	↕	↕
	1N to 2N					
	2N to 3N					
	3N to 4N					
Travel (mm)		0.25			0.3	0.25
Ground terminal		●	●	—	—	—
Operating temperature range		-40°C to +90°C		-20°C to +70°C	-40°C to +95°C	-30°C to +85°C
Automotive use		●	●	—	●	—
Life Cycle						
Electrical performance	Rating (max.) (Resistive load)	50mA 12V DC				
	Rating (min.) (Resistive load)	10μA 1V DC				
	Insulation resistance	100MΩ min. 100V DC 1min.				
	Voltage proof	250V AC 1min.				
Durability	Vibration	10 to 55 to 10Hz/min., the amplitude is 1.5mm for all the frequencies, in the 3 direction of X, Y and Z for 2 hours respectively				
	Lifetime	Shall be in accordance with individual specifications.				
Environmental performance	Cold	-40°C 96h		-30°C 96h	-40°C 96h	
	Dry heat	90°C 96h		80°C 96h	90°C 96h	
	Damp heat	60°C, 90 to 95%RH 96h			60°C, 90 to 95%RH 1,000h	
Page		173	175	180	182	228

W : Width. The most outer dimension excluding terminal portion.
D : Depth. The most outer dimension excluding terminal portion.
H : Height. The minimum dimension if there are variances.

TACT Switch™ Soldering Conditions 235
TACT Switch™ Cautions 236

Notes

- The automotive operating temperature range to be individually discussed upon request.
- Indicates applicability to all products in the series.

TACT Switch™

Sharp Feeling

Soft Feeling

Snap-In Type

Surface Mount Type

Radial Type

TACT Switch™ / Soldering Conditions

Condition for Reflow

Available for Surface Mount Type.

Temperature profile

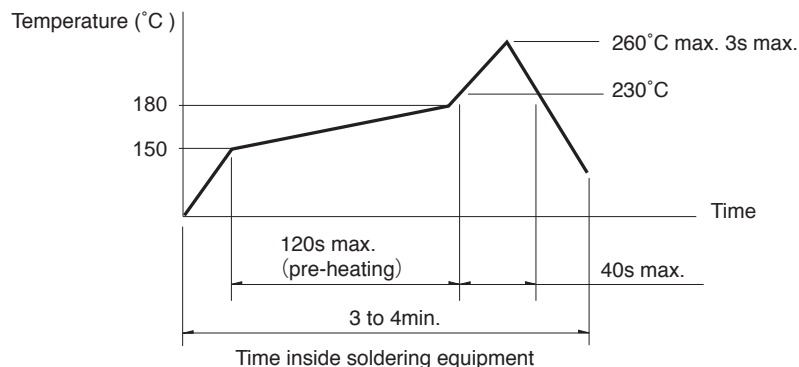

Notes

1. Please confirm the specifications of our product for the detailed condition.
2. Soldering conditions differ depending on reflow soldering machines.
Prior verification of soldering condition is highly recommended.

Conditions for Auto-dip

Available for Snap-in Type and Radial Type.

Items	Condition
Flux built-up	Mounting surface should not be exposed to flux
Preheating temperature	Ambient temperature of the soldered surface of PC board. 100°C max.
Preheating time	60s max.
Soldering temperature	260°C max.
Duration of immersion	5s max.
Number of soldering	2times max.

SKHH Series

Items	Condition
Flux built-up	Mounting surface should not be exposed to flux
Preheating temperature	Ambient temperature of the soldered surface of PC board. 110°C max.
Preheating time	60s max.
Soldering temperature	260°C max.
Duration of immersion	5s max.
Number of soldering	2times max.

SKHL Top Push Type, SKQJ Series

Items	Condition
Flux built-up	Mounting surface should not be exposed to flux
Preheating temperature	Ambient temperature of the soldered surface of PC board. 100°C max.
Preheating time	45s max.
Soldering temperature	255°C max.
Duration of immersion	5s max.
Number of soldering	2times max.

Notes

1. Prevent flux penetration from the top side of the TACT Switch™.
2. Switch terminals and a PC board should not be coated with flux prior to soldering.
3. The second soldering should be done after the switch is stable with normal temperature.
4. Use the flux with a specific gravity of min 0.81.
(EC-19S-8 by TAMURA CORPORATION, or equivalents.)

Manual Soldering

Items	Condition
Soldering temperature	350°C max.
Duration of soldering	3s max.
Capacity of soldering iron	60W max.

SKHH, SKHW Series

Items	Condition
Soldering temperature	360°C max.
Duration of soldering	3s max.
Capacity of soldering iron	60W max.

SKTD, SKTG, SKQJ, SKSN Series

Items	Condition
Soldering temperature	350°C max.
Duration of soldering	3s max.
Capacity of soldering iron	20W max.

TACT Switch™

Sharp Feeling

Soft Feeling

Snap-in Type

Surface Mount Type

Radial Type

Looking for pricing, stock, or lifecycle information?

Click below to explore more details on WIN SOURCE:

 [View SKHHQNA010 on WIN SOURCE](#)

 [ALPS Electric Information](#)

Optimize Your Supply Chain with WIN SOURCE Solutions

-  Global Sourcing Solution
-  Obsolete Management
-  Cost Control Management
-  Shortage Management
-  Alternative Solution
-  Excess Inventory Management