



**THE DATASHEET OF
GA.107.201111**





TAOGLAS®



Datasheet

Magnetic Mount 5G/4G Cellular Antenna

Part No:
GA.107.201111

Description

5G/4G Cellular Magnetic Whip Antenna

Features:

Delivers high performance for all 5G/4G networks worldwide

600MHz to 6000MHz

Magnetic mount

Dimensions: Ø29.5mm x 116mm

Superior Super Magnet – Neodymium N35

Custom cables and connectors available

RoHS Compliant

1.	Introduction	2
2.	Specification	3
3.	Antenna Characteristics	5
4.	Radiation Patterns	9
5.	Mechanical Drawing	26
6.	Packaging	27
7.	Magnetic Pull Force (Kilogram-Force (kgf))	28
<hr/>		
	Changelog	29

Taoglas makes no warranties based on the accuracy or completeness of the contents of this document and reserves the right to make changes to specifications and product descriptions at any time without notice. Taoglas reserves all rights to this document and the information contained herein. Reproduction, use or disclosure to third parties without express permission is strictly prohibited.



1. Introduction



The GA.107 magnetic cellular band antenna delivers marked improvements in efficiency and gain across all common frequencies in use for cellular bands today. Now one antenna can be used in place of multiple part numbers.

Small enough to be used indoors and outdoors, the antenna performance has been designed to take advantage of any metal plate (ground-plane) it attaches to deliver best of class performance.

The GA.107 features a superior super magnet made form Neodymium N35, giving the antenna a maximum pull-force of 1.92 kilogram-force (kgf).

A reliable return loss of <math><10\text{dB}</math> when mounted on a metal plate ensures it complies with the industry standards set by module makers and networks worldwide.

Cables and Connectors are customizable, contact your regional Taoglas sales office for support or installation instructions.

2. Specification

LTE Electrical									
Band	Frequency (MHz)	Measurement	Efficiency (%)	Average Gain (dB)	Peak Gain (dBi)	Impedance	Polarization	Radiation Pattern	Max. input power
5G NR/4G Band 71	617-698	30x30cm Ground Plane	22.9	-6.40	-1.50	50 Ω	Linear	Omni	50W
		Free Space	31.1	-5.07	0.87				
4G/3G Band 12,13,14,17,28,29	698-806	30x30cm Ground Plane	51.8	-2.86	2.96				
		Free Space	22.8	-6.42	-0.61				
4G/3G/NB-IoT/Cat M Band 5,8,18,19,20,26,27	824-960	30x30cm Ground Plane	75.9	-1.20	3.01				
		Free Space	42.6	-3.70	1.84				
5G NR/4G Band 21,32,74,75,76	1427-1518	30x30cm Ground Plane	30.8	-5.11	0.12				
		Free Space	35.6	-4.49	1.02				
4G/3G Band 1,2,3,4,9,23,25,35,39,66	1710-2200	30x30cm Ground Plane	41.3	-3.84	2.87				
		Free Space	40.9	-3.88	1.45				
4G/3G Band 7,30,38,40,41	2300-2690	30x30cm Ground Plane	43.9	-3.58	2.77				
		Free Space	44.0	-3.57	1.75				
5G NR/4G Band 22,42,48,77,78,79	3300-5000	30x30cm Ground Plane	60.6	-2.17	7.51				
		Free Space	59.4	-2.27	5.04				
LTE5200/Wi-Fi5800	5150-5925	30x30cm Ground Plane	52.4	-2.80	5.30				
		Free Space	50.0	-3.01	4.91				

*Measured with 300mm of RG174 cable

Mechanical	
Dimensions	Length 116mm, Φ29.5mm Base
Weight	21g
Material	TPU + ABS
Connector	SMA Male
Cable	2000mm RG-174

Environmental	
Operation Temperature	-40°C to 85°C
Relative Humidity	Non-condensing 65°C 95% RH

5G/4G Bands				
Band Number	5G NR / FR1 / LTE / LTE-Advanced / WCDMA / HSPA / HSPA+ / TD-SCDMA			
	Uplink	Downlink	30x30cm GROUND PLANE	Free Space
B1	1920 to 1980	2110 to 2170	✓	✓
B2	1850 to 1910	1930 to 1990	✓	✓
B3	1710 to 1785	1805 to 1880	✓	✗
B4	1710 to 1755	2110 to 2155	✗	✗
B5	824 to 849	869 to 894	✓	✓
B7	2500 to 2570	2620 to 2690	✓	✓
B8	880 to 915	925 to 960	✓	✓
B9*	1749.9 to 1784.9	1844.9 to 1879.9	✓	✗
B11	1427.9 to 1447.9	1475.9 to 1495.9	✓	✓
B12	699 to 716	729 to 746	✓	✓
B13	777 to 787	746 to 756	✓	✓
B14	788 to 798	758 to 768	✓	✓
B17	704 to 716	734 to 746	✓	✓
B18	815 to 830	860 to 875	✓	✓
B19	830 to 845	875 to 890	✓	✓
B20	832 to 862	791 to 821	✓	✓
B21	1447.9 to 1462.9	1495.9 to 1510.9	✓	✓
B22*	3410 to 3490	3510 to 3590	✓	✓
B23*	2000 to 2020	2180 to 2200	✓	✓
B24	1626.5 to 1660.5	1525 to 1559	✗	✗
B25	1850 to 1915	1930 to 1995	✓	✓
B26	814 to 849	859 to 894	✓	✓
B27*	807 to 824	852 to 869	✓	✓
B28	703 to 748	758 to 803	✓	✓
B29		717 to 728	✓	✓
B30	2305 to 2315	2350 to 2360	✓	✓
B31	452.5 to 457.5	462.5 to 467.5	✗	✗
B32		1452 to 1496	✓	✓
B34		2010 to 2025	✓	✓
B35		1850 to 1910	✓	✓
B36		1930 to 1990	✓	✓
B37		1910 to 1930	✓	✓
B38		2570 to 2620	✓	✓
B39		1880 to 1920	✓	✓
B40		2300 to 2400	✓	✓
B41		2496 to 2690	✓	✓
B42		3400 to 3600	✓	✓
B43		3600 to 3800	✓	✓
B45		1447 to 1467	✓	✓
B46		5150 to 5925	✓	✓
B47		5855 to 5925	✓	✓
B48		3550 to 3700	✓	✓
B49		3550 to 3700	✓	✓
B50		1432 to 1517	✓	✓
B51		1427 to 1432	✓	✓
B52		3300 to 3400	✓	✓
B53		2483.5 to 2495	✓	✓
B65	1920 to 2010	2110 to 2200	✓	✓
B66	1710 to 1780	2110 to 2200	✓	✗
B68	698 to 728	753 to 783	✓	✓
B69		2570 to 2620	✓	✓
B70	1695 to 1710	1995 to 2020	✗	✗
B71	663 to 698	617 to 652	✗	✓
B72	451 to 456	461 to 466	✗	✗
B73	450 to 455	460 to 465	✗	✗
B74	1427 to 1470	1475 to 1518	✓	✓
B75		1432 to 1517	✓	✓
B76		1427 to 1432	✓	✓
B77		3300 to 4200	✓	✓
B78		3300 to 3800	✓	✓
B79		4400 to 5000	✓	✓
B85	698 to 716	728 to 746	✓	✓
B87	410 to 415	420 to 425	✗	✗
B88	412 to 417	422 to 427	✗	✗

3. Antenna Characteristics

3.1 Test Setup

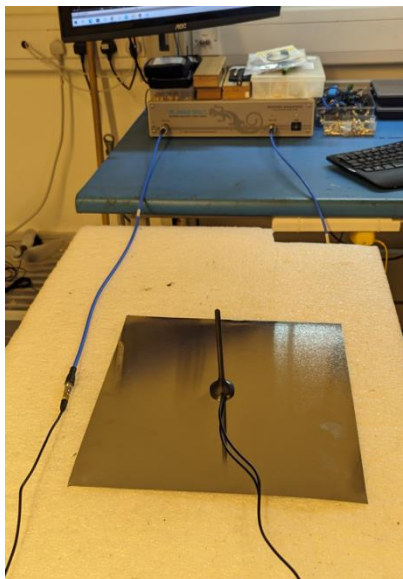
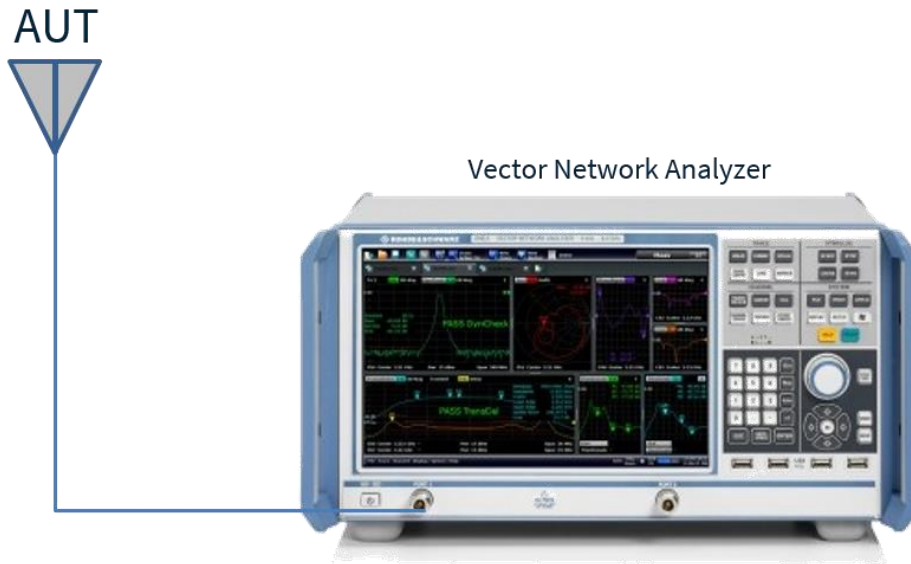

30X30cm Ground Plane

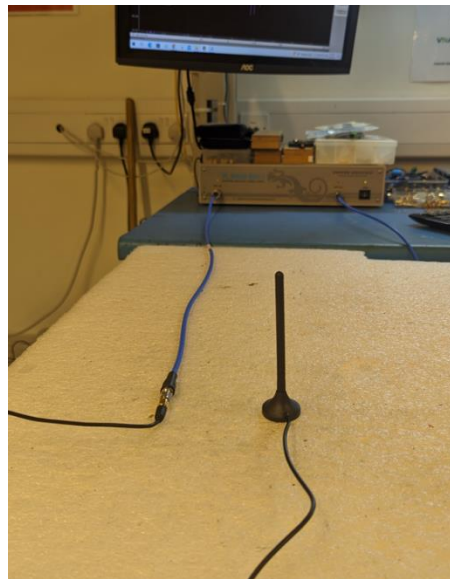

Free Space

3.2 Return Loss

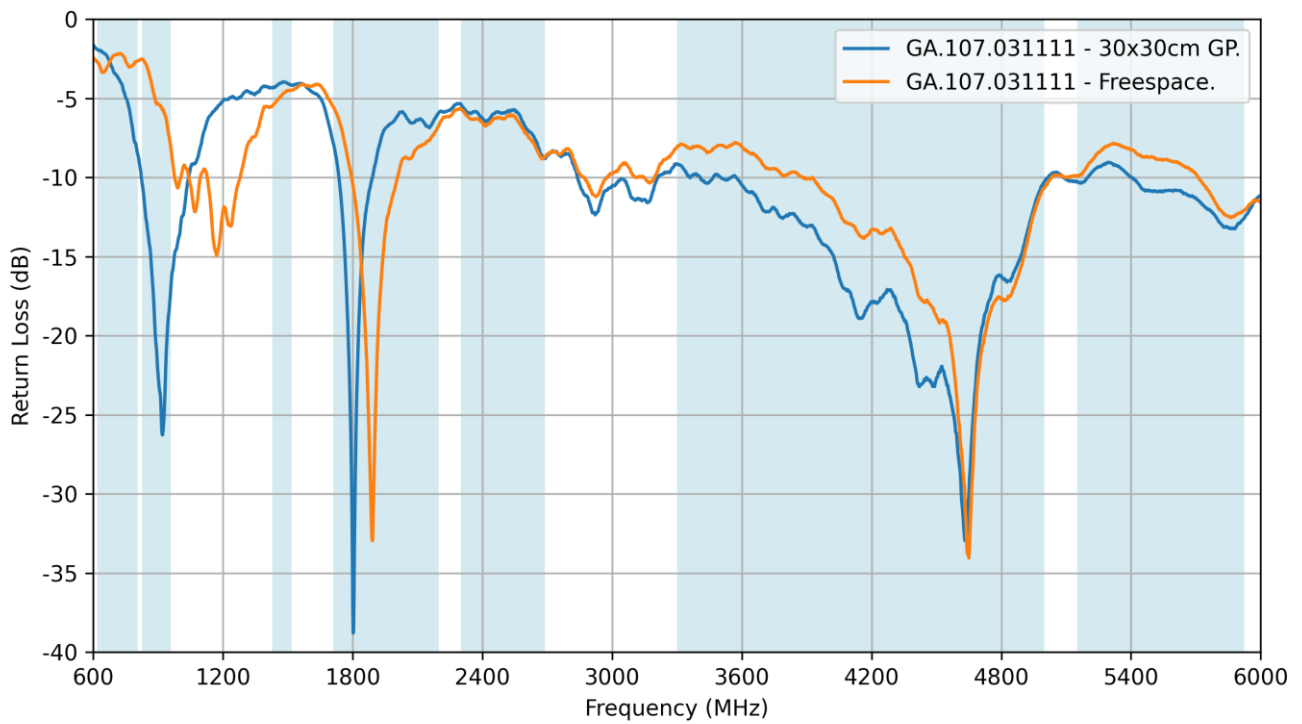

3.3 VSWR

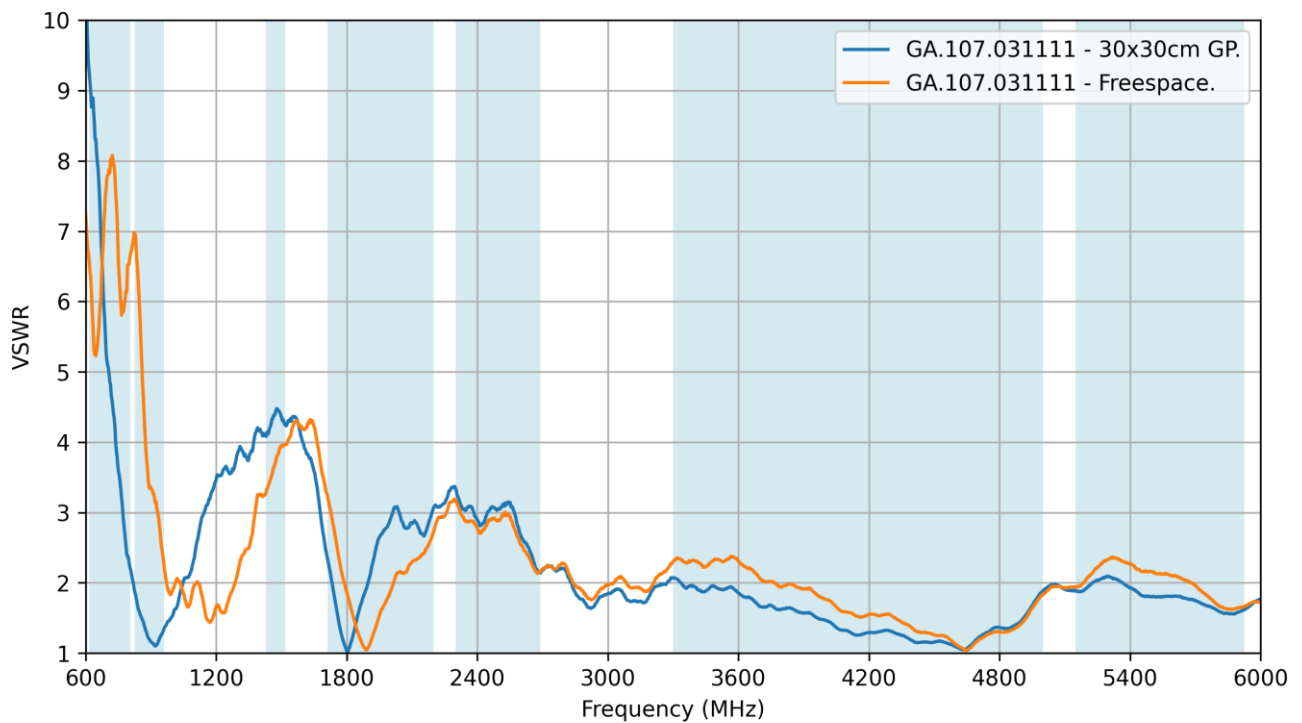

3.4 Efficiency

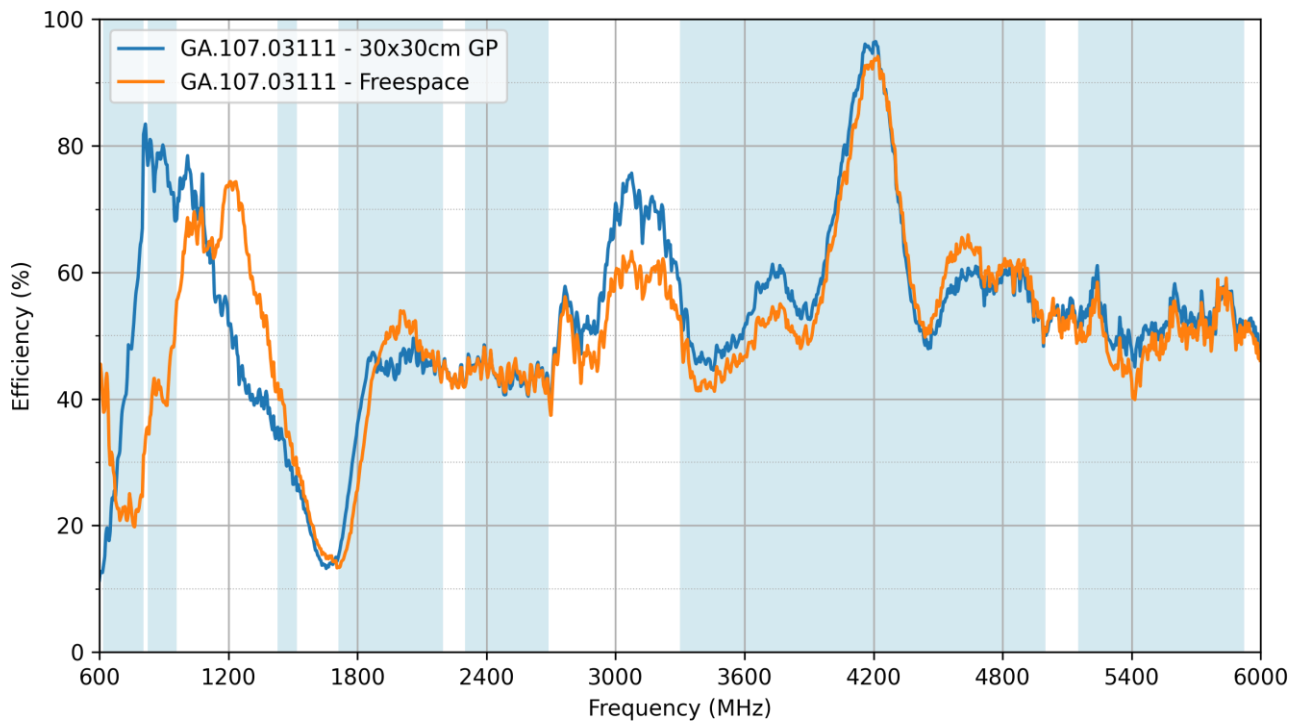

3.5 Average Gain

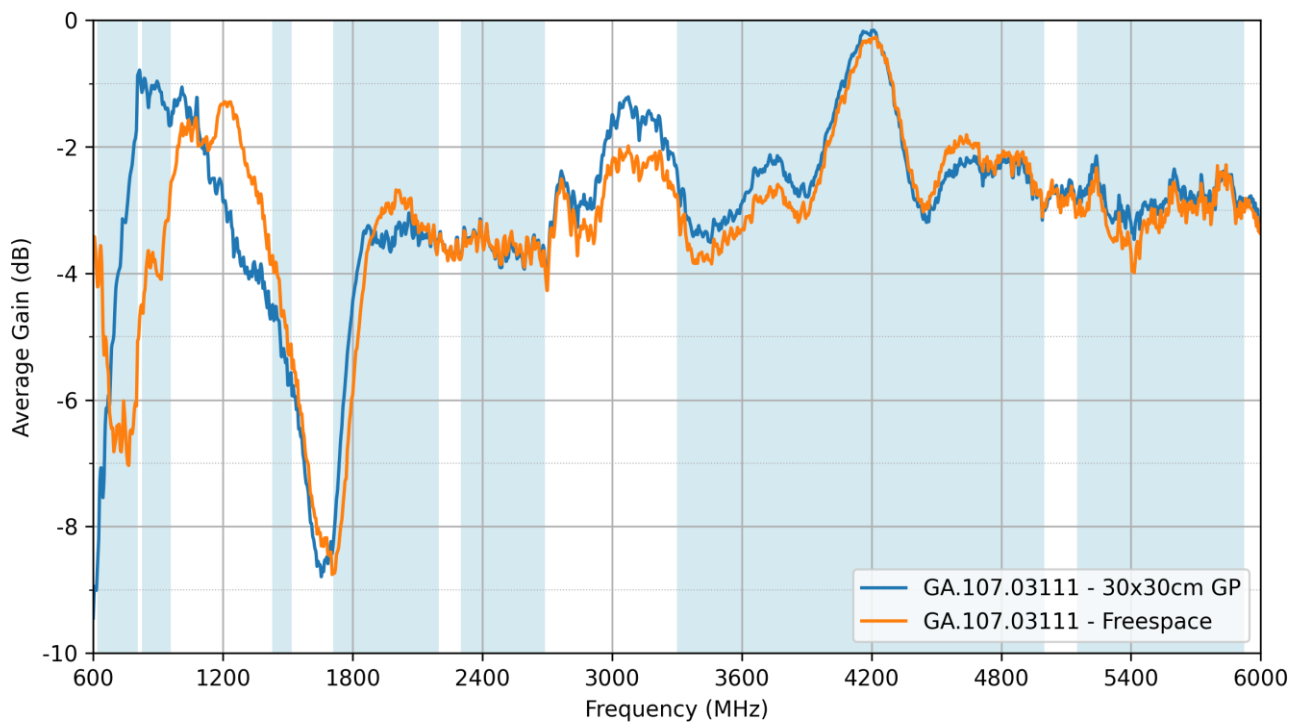

3.6 Peak Gain

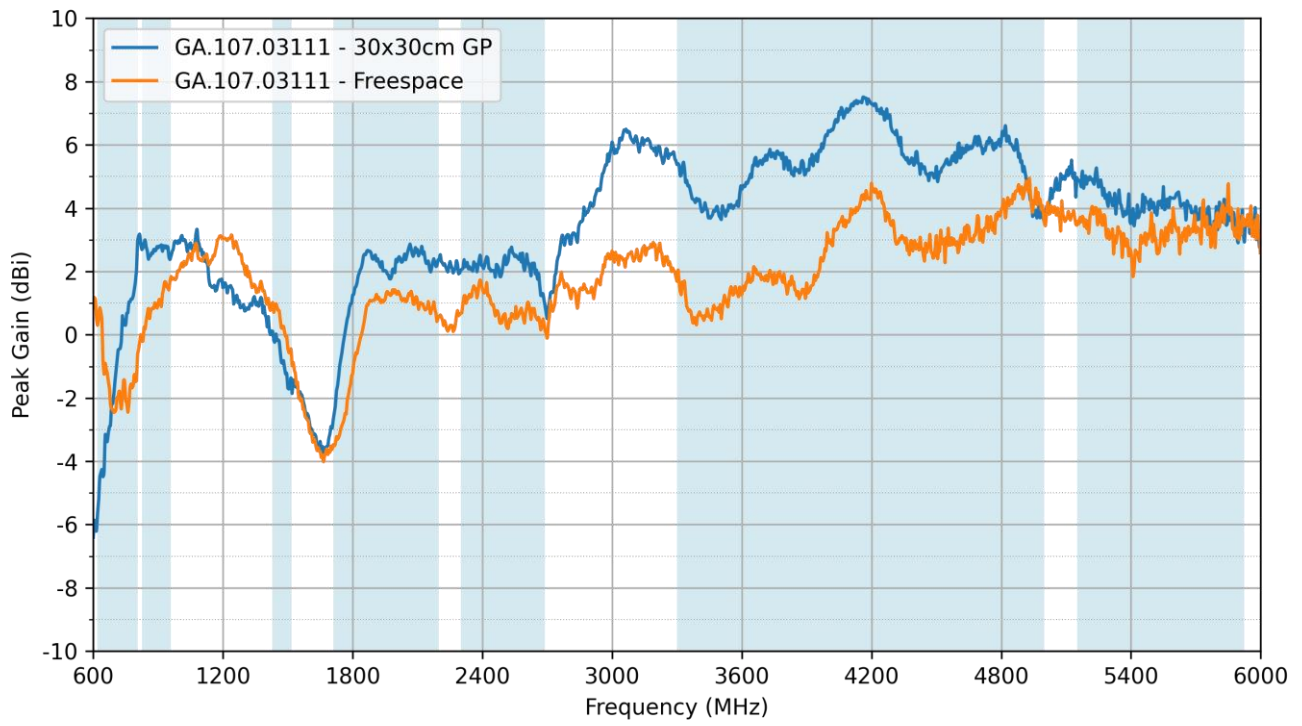

4. Radiation Patterns

4.1 Test Setup

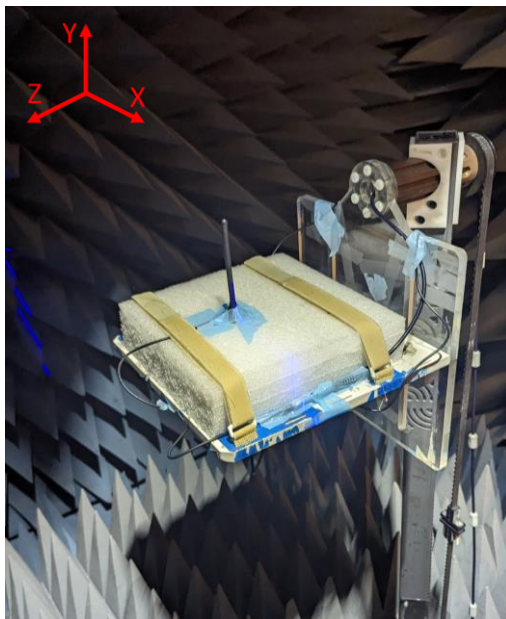
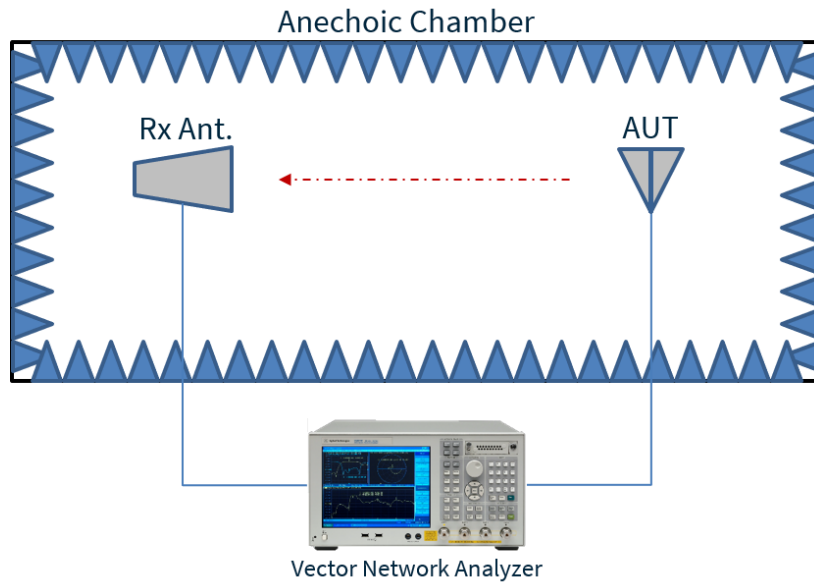

Free Space

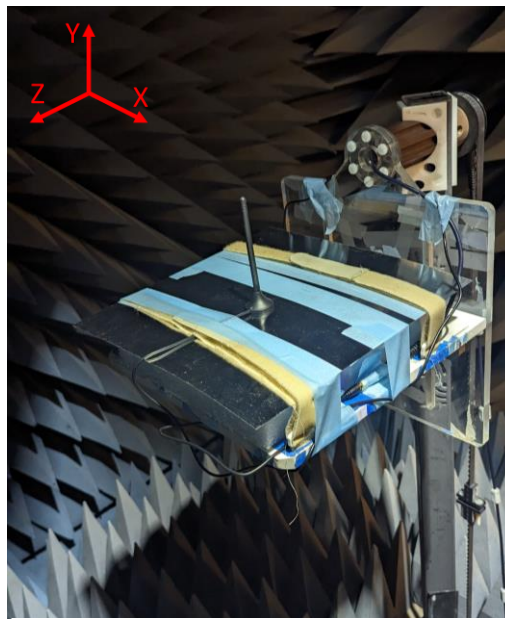

30X30cm Ground Plane

4.2 30x30cm Ground Plane Patterns at 658 MHz

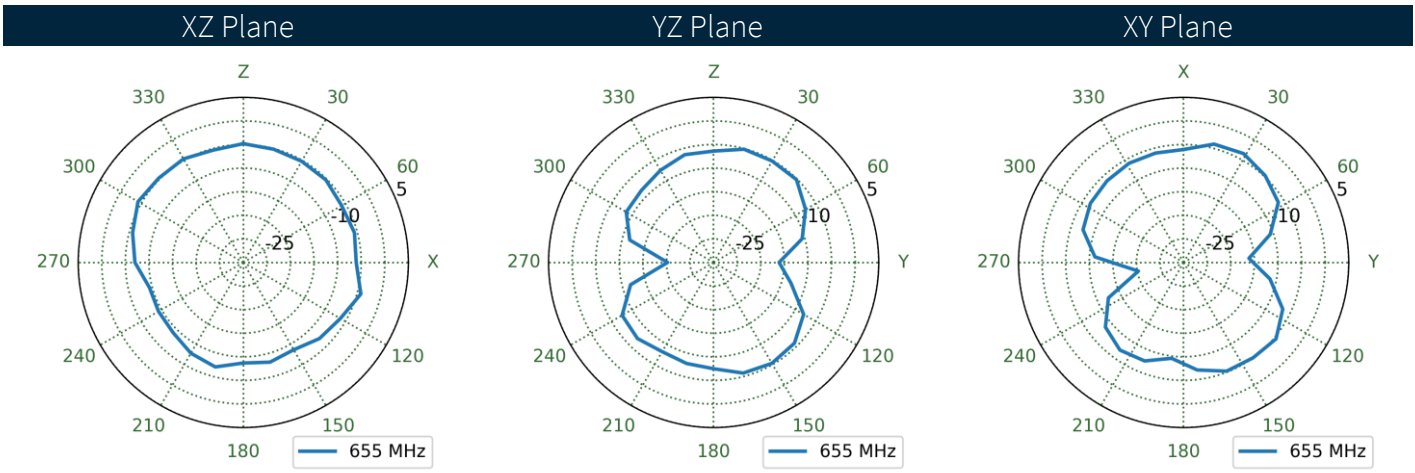
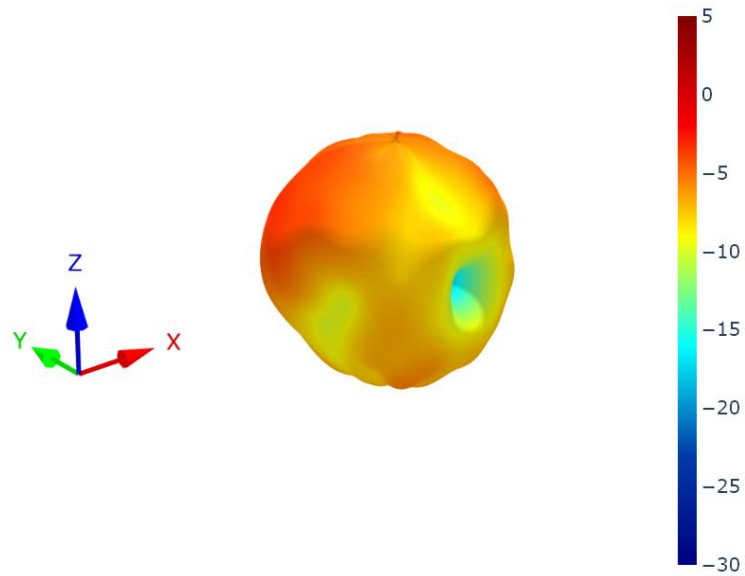

4.3 Free Space Patterns at 658 MHz

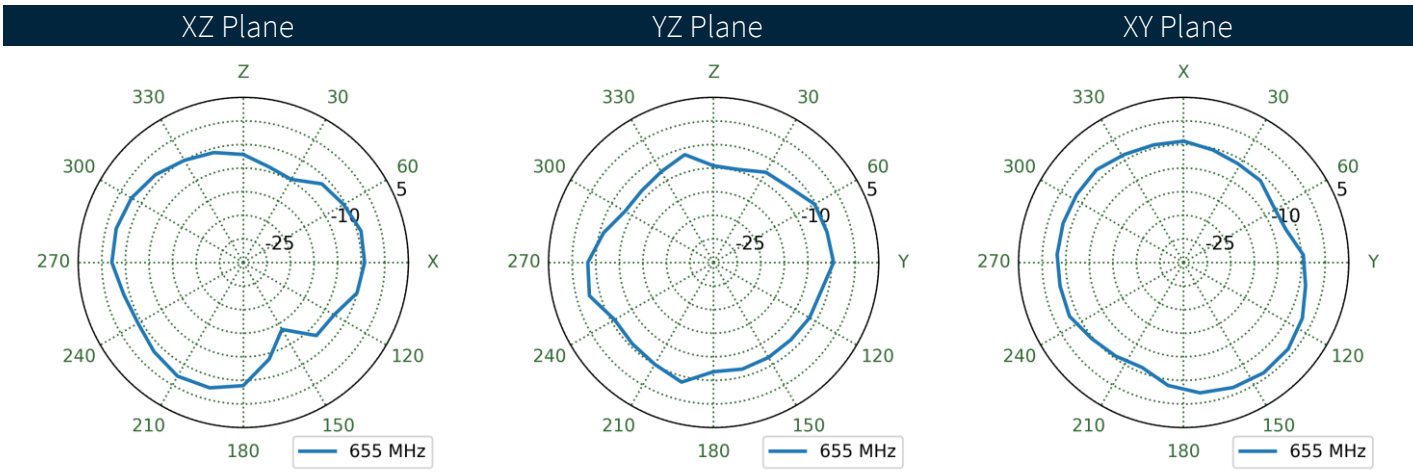
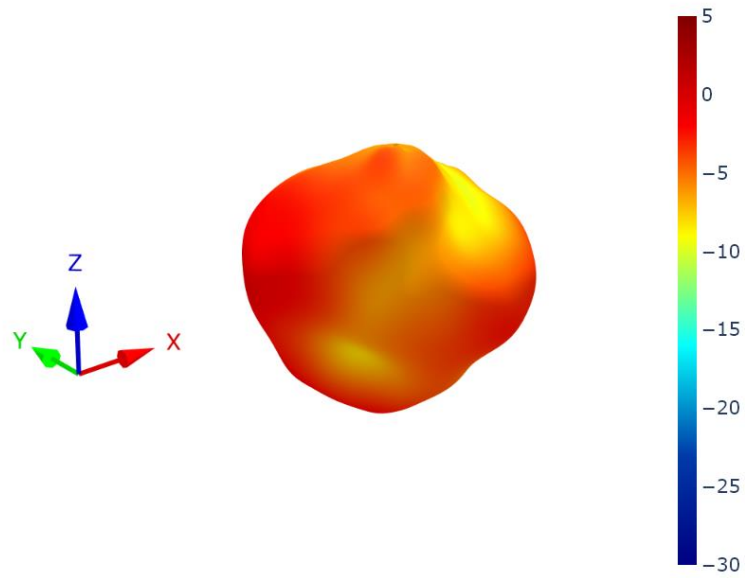

4.4 30x30cm Ground Plane Patterns at 752 MHz

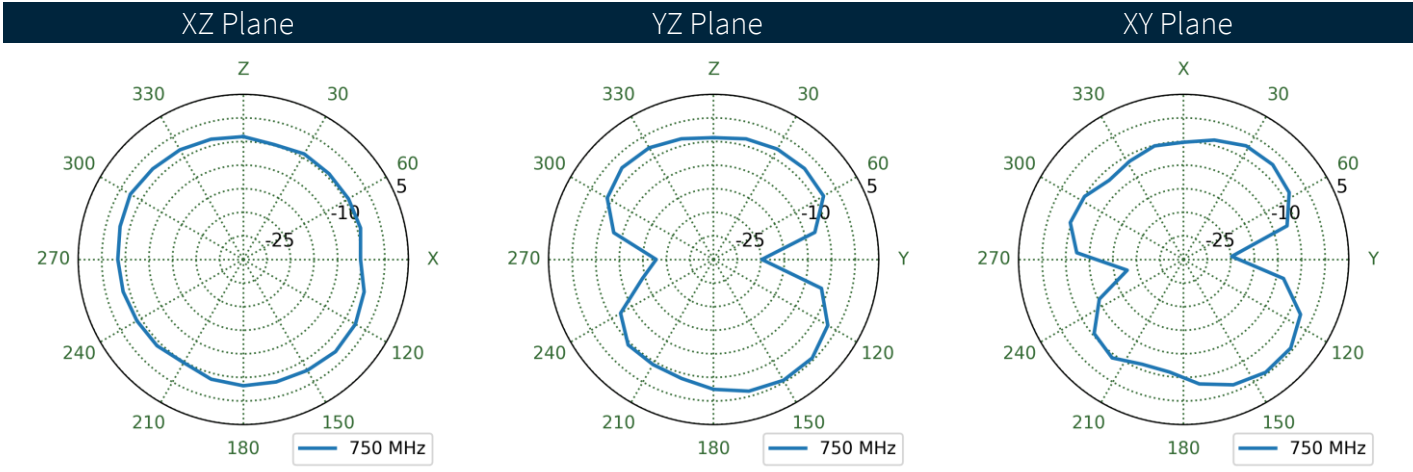
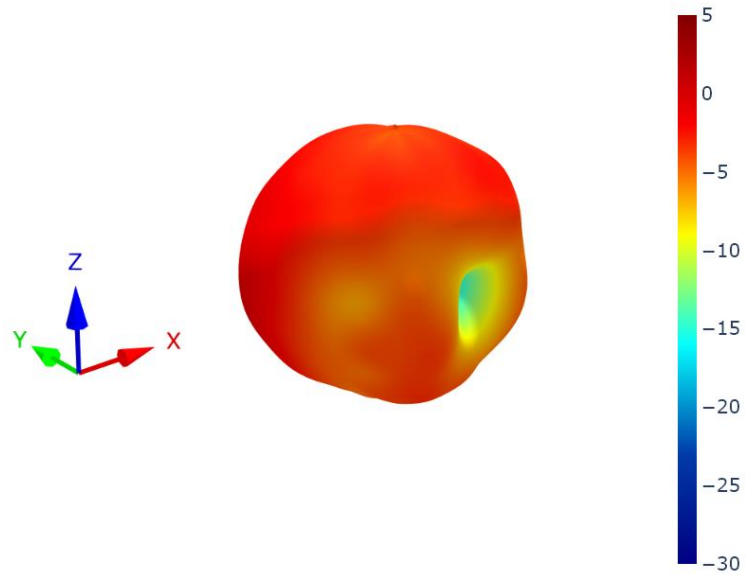

4.5 Free Space Patterns at 752 MHz

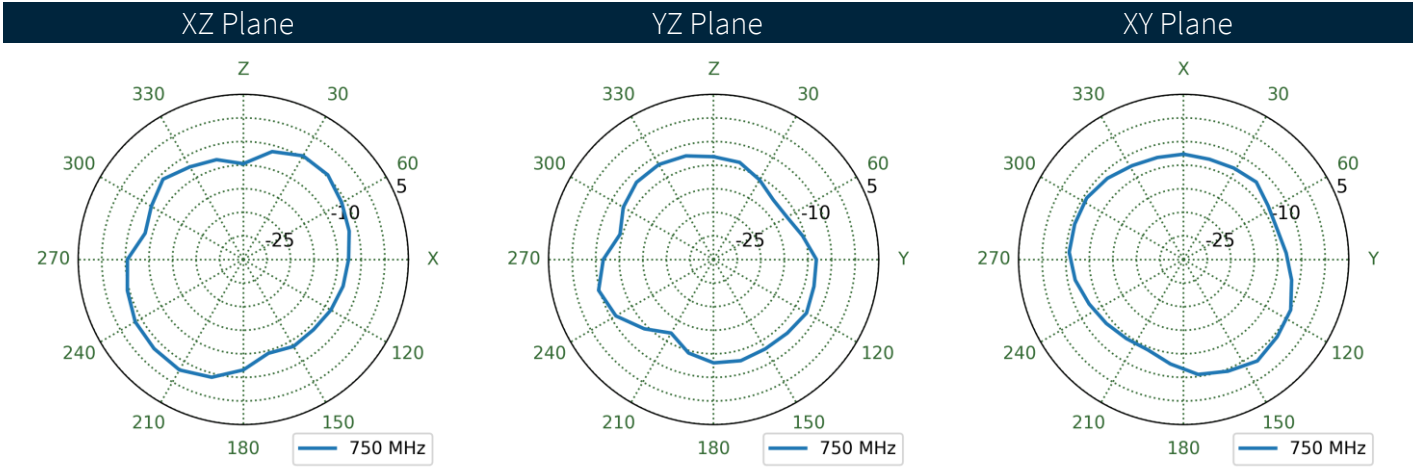
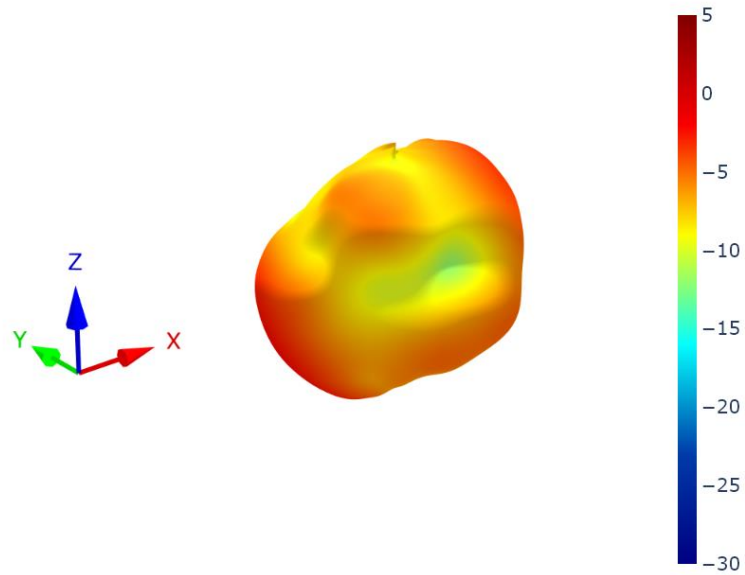

4.6 30x30cm Ground Plane Patterns at 892 MHz

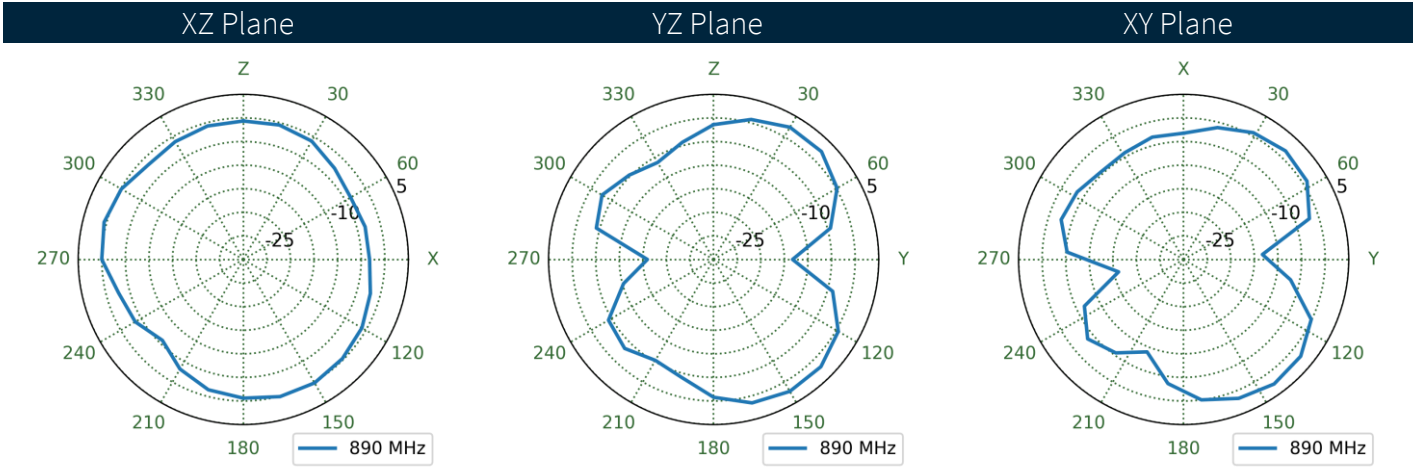
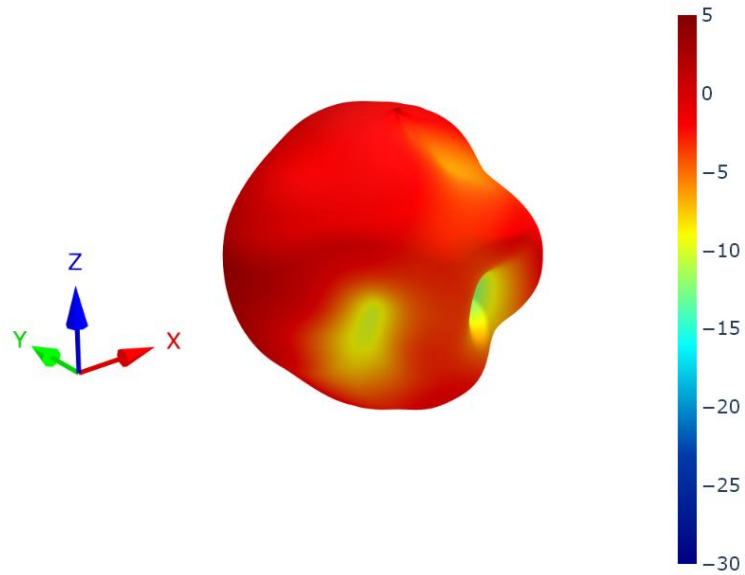

4.7 Free Space Patterns at 892 MHz

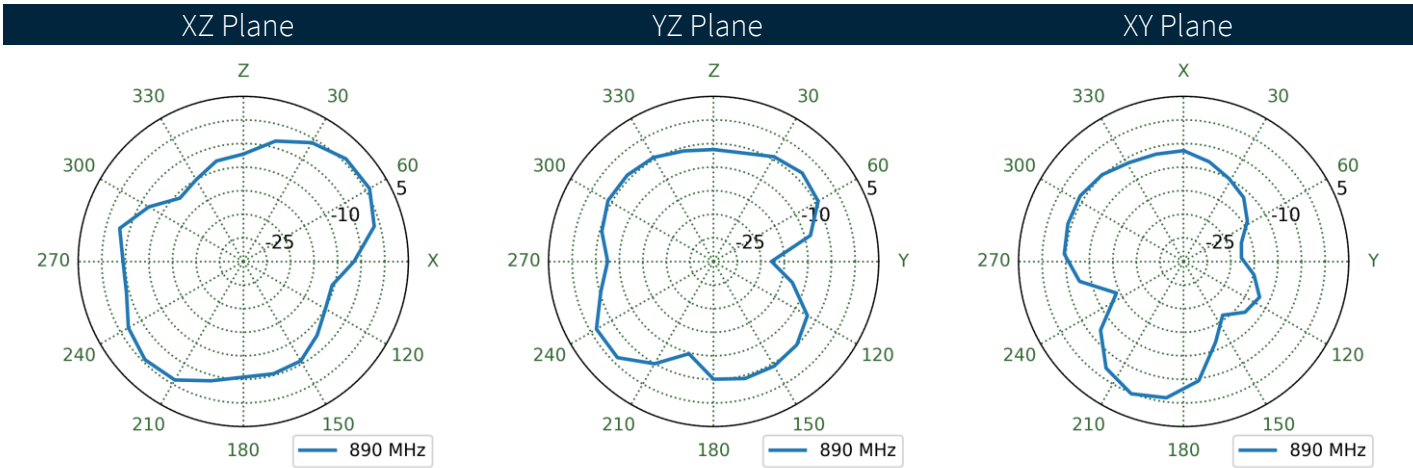
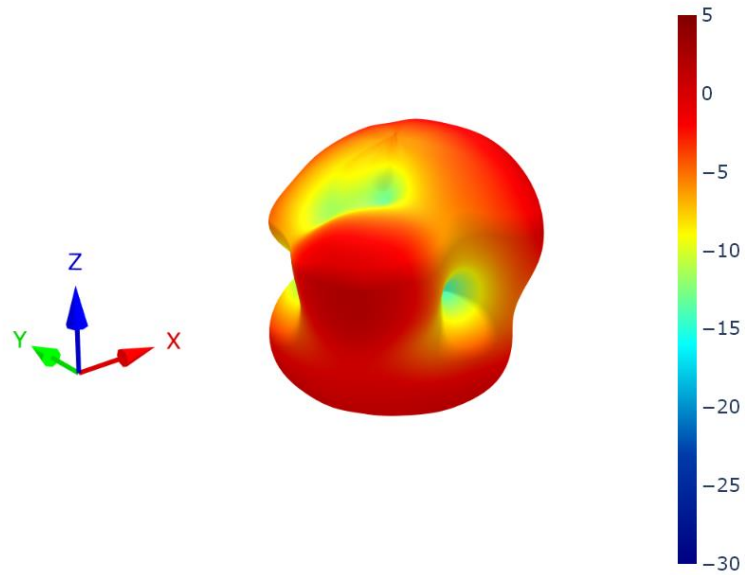

4.8 30x30cm Ground Plane Patterns at 1473 MHz

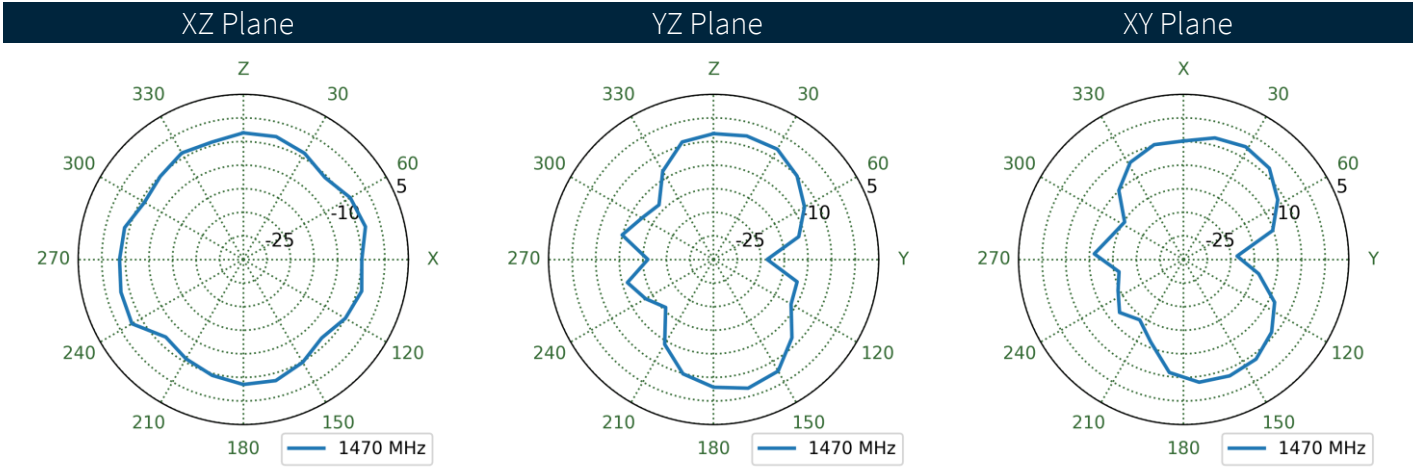
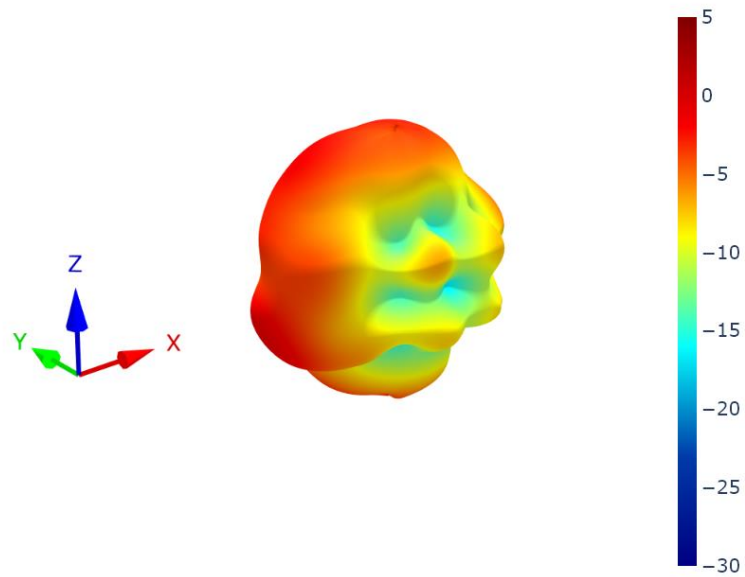

4.9 Free Space Patterns at 1473 MHz

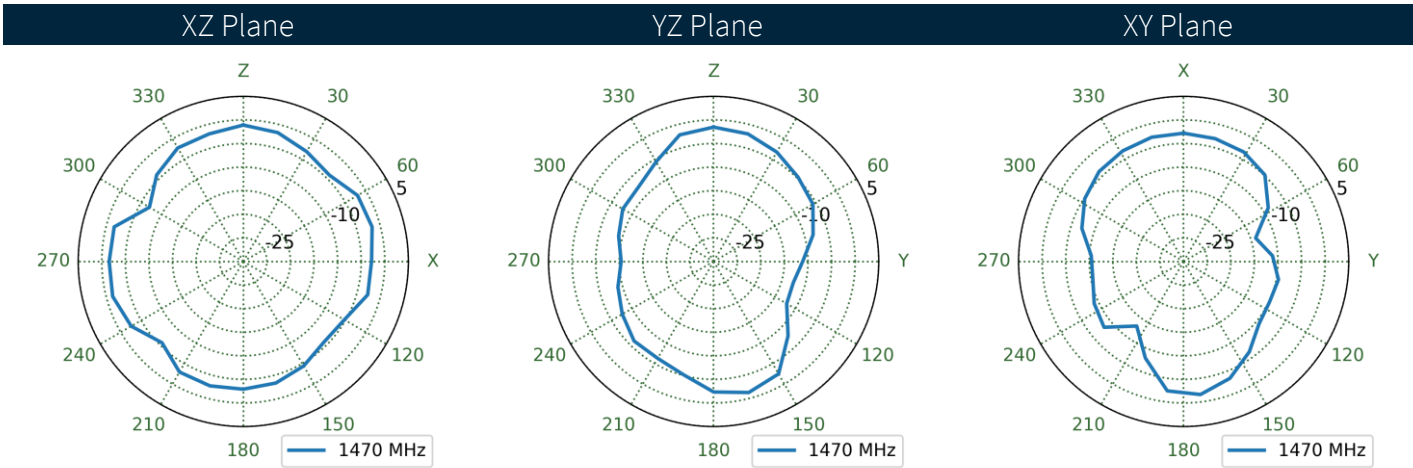
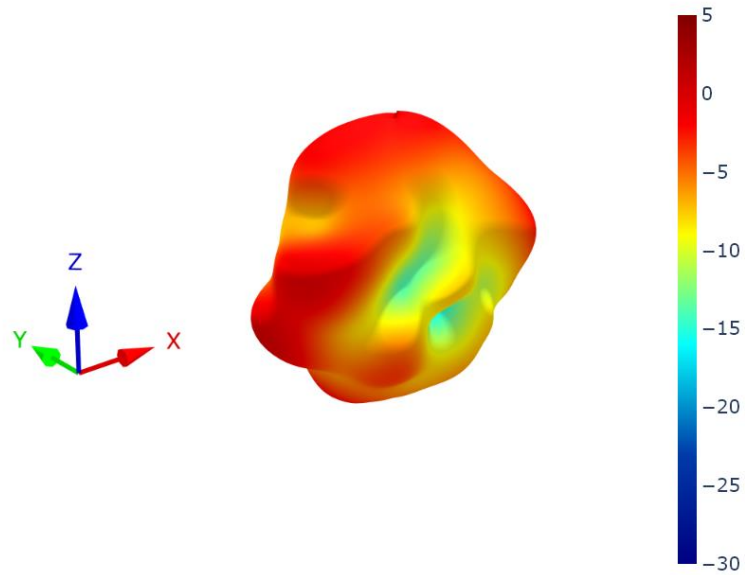

4.10 30x30cm Ground Plane Patterns at 1955 MHz

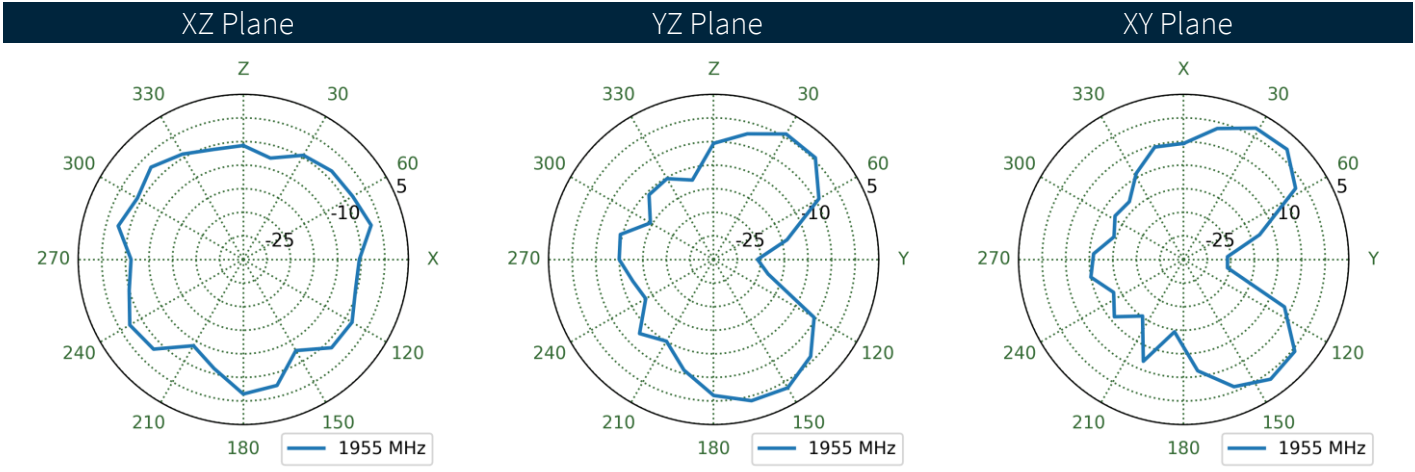
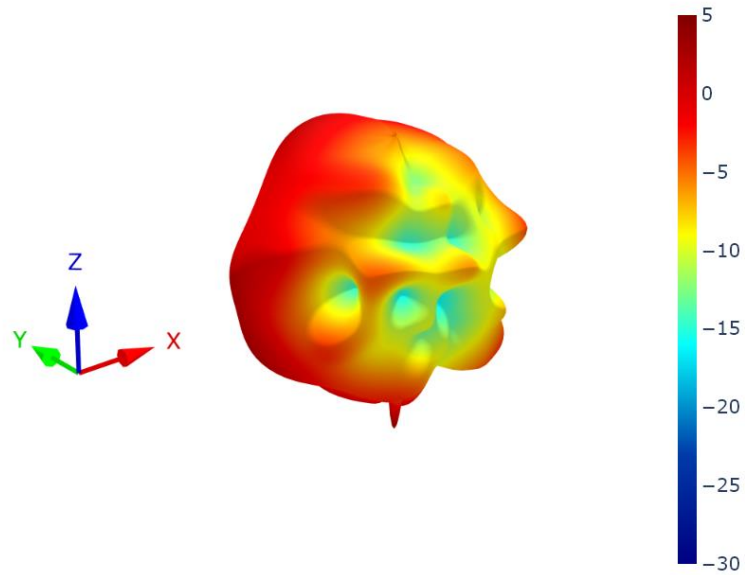

4.11 Free Space Patterns at 1955 MHz

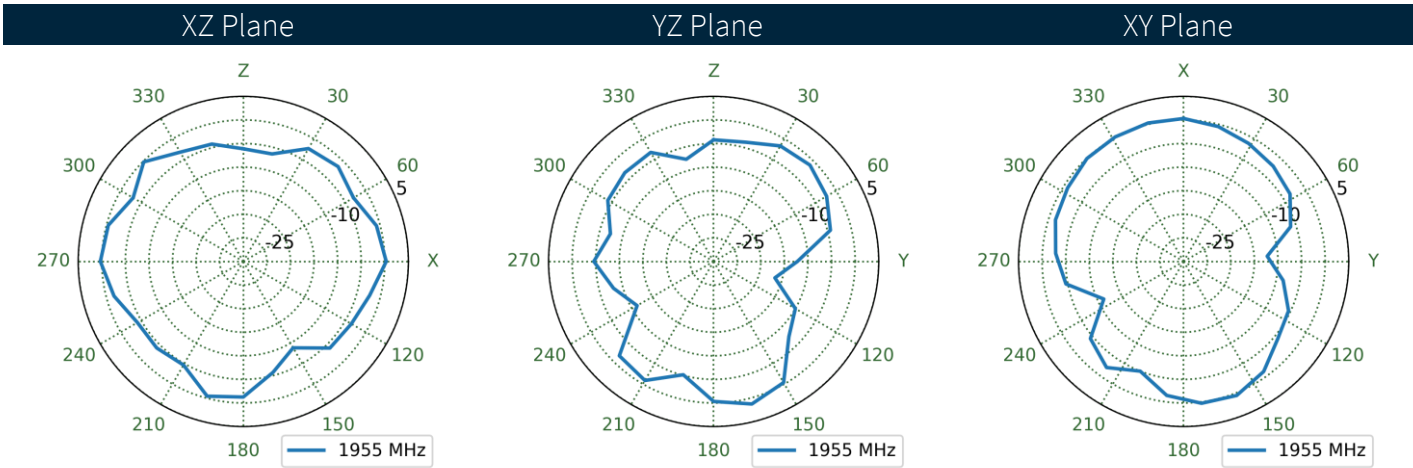
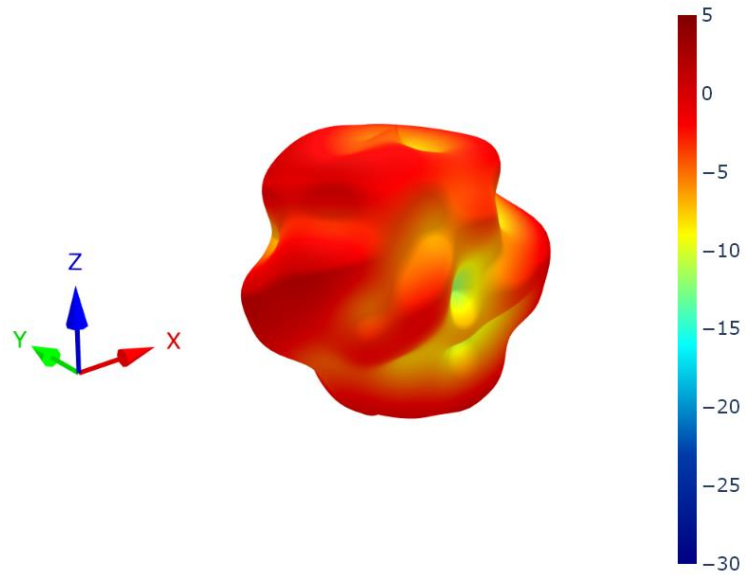

4.12 30x30cm Ground Plane Patterns at 2495 MHz

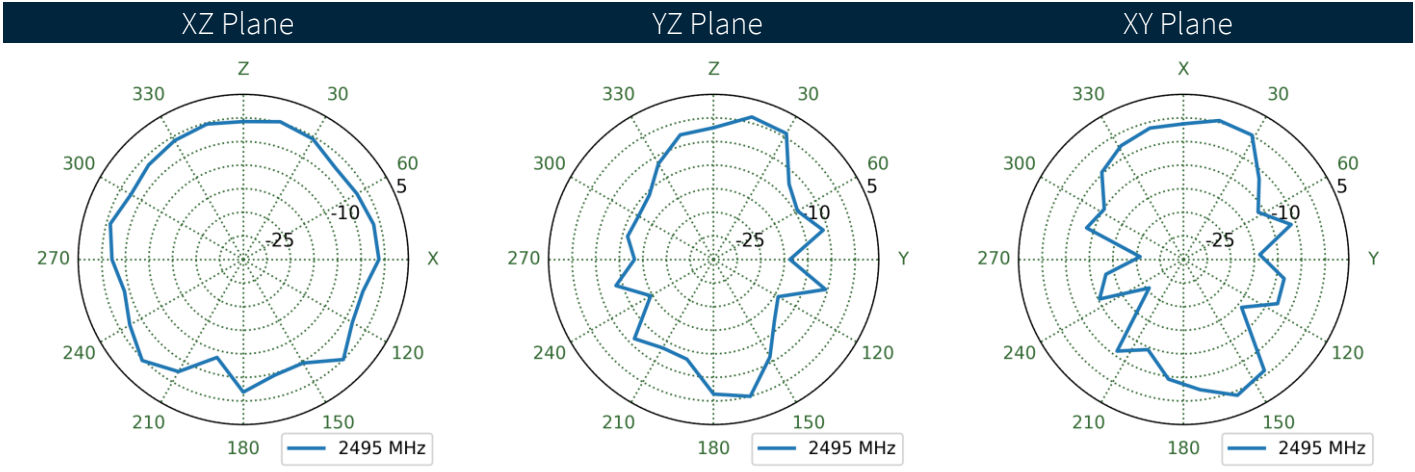
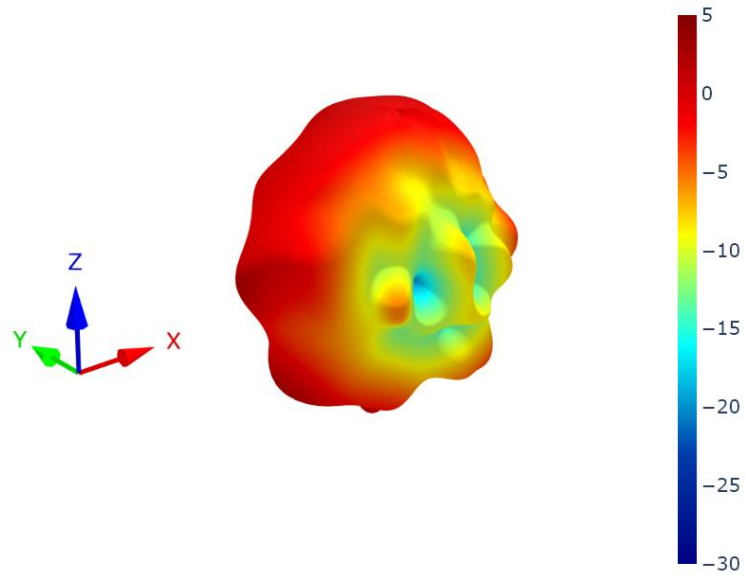

4.13 Free Space Patterns at 2495 MHz

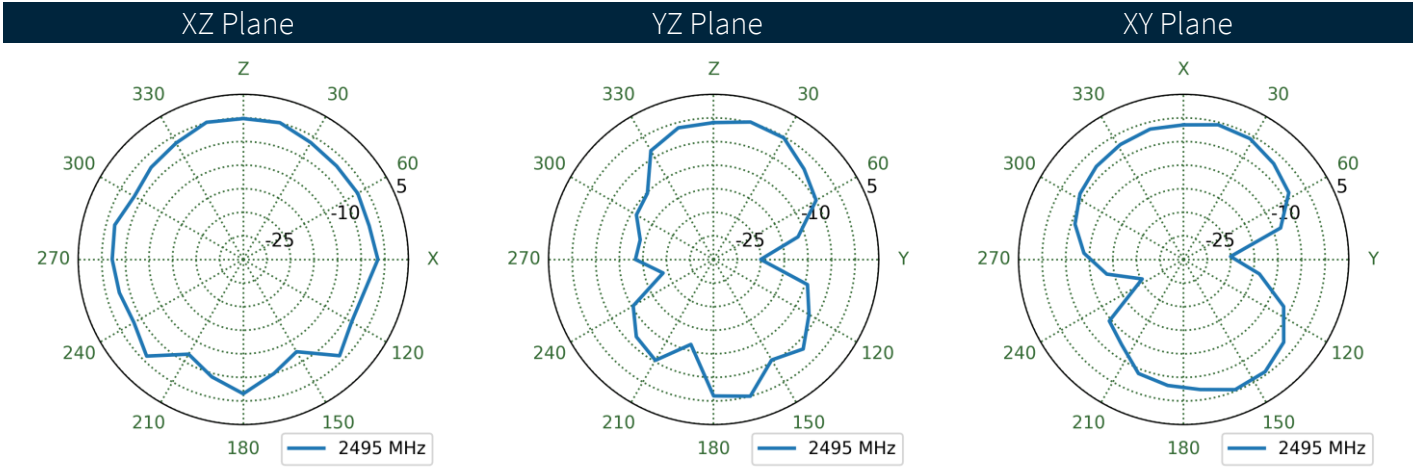
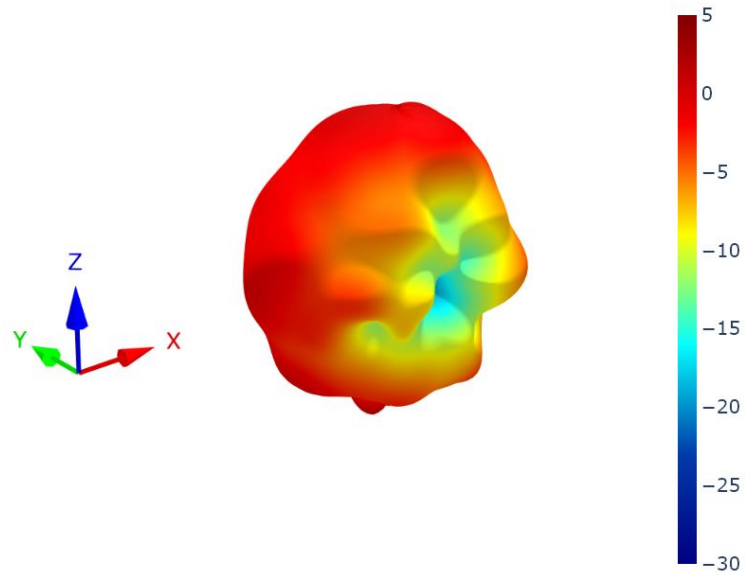

4.14 30x30cm Ground Plane Patterns at 4150 MHz

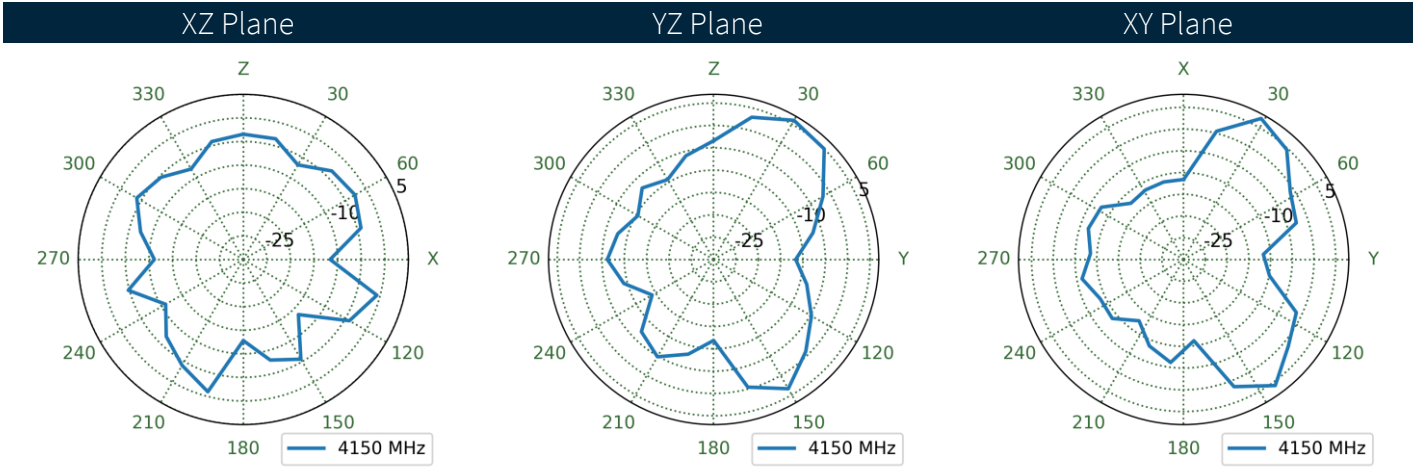
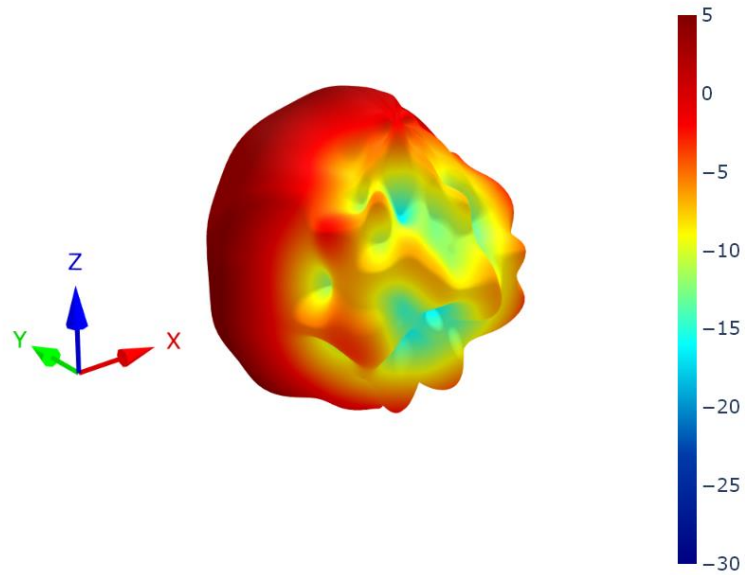

4.15 Free Space Patterns at 4150 MHz

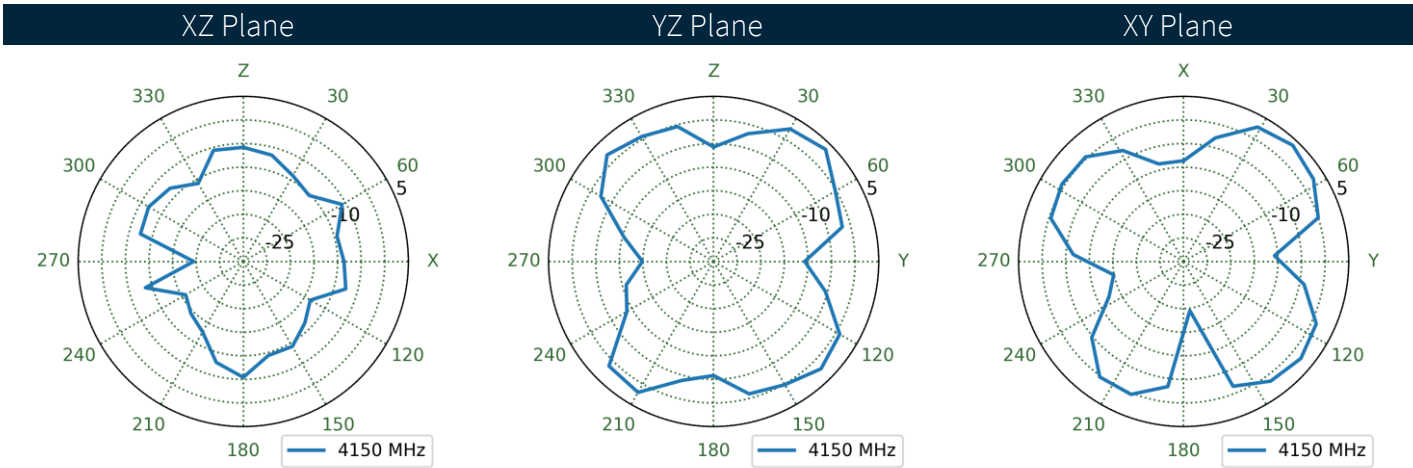
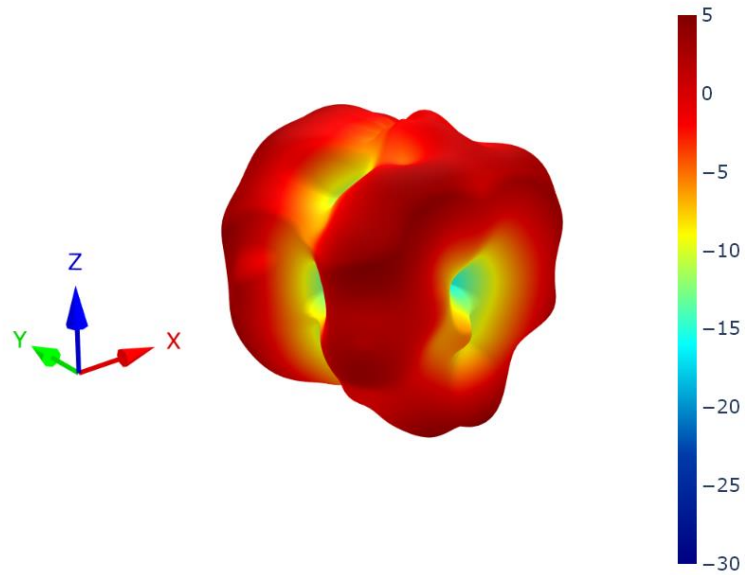

4.16 30x30cm Ground Plane Patterns at 5538 MHz

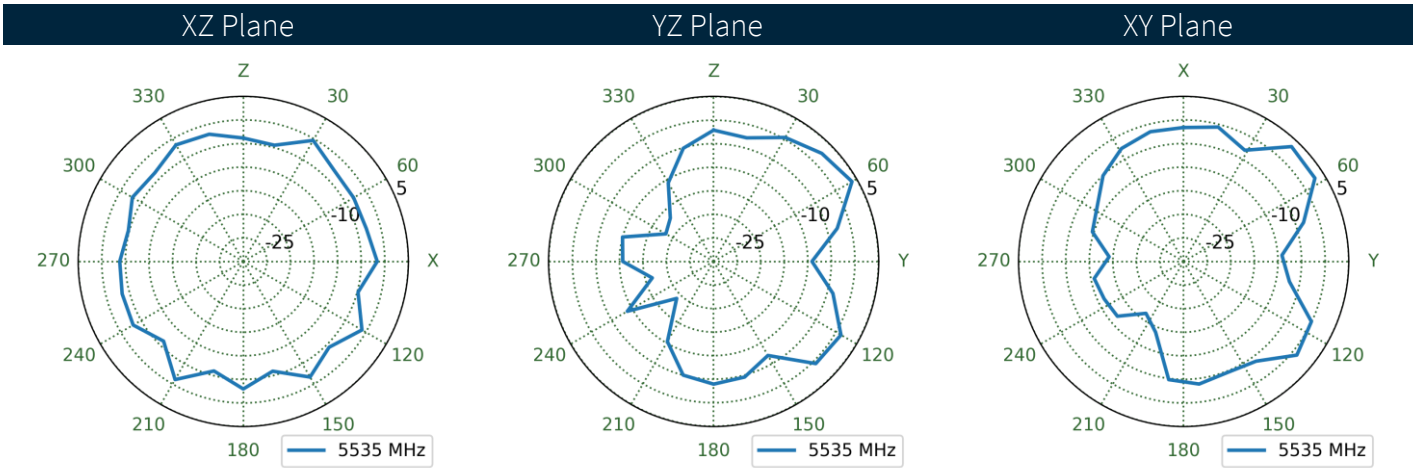
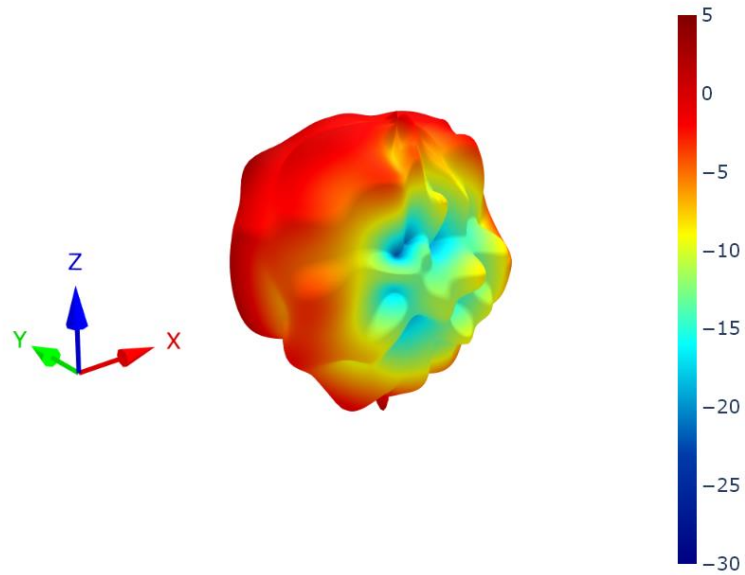

4.17 Free Space Patterns at 5538 MHz

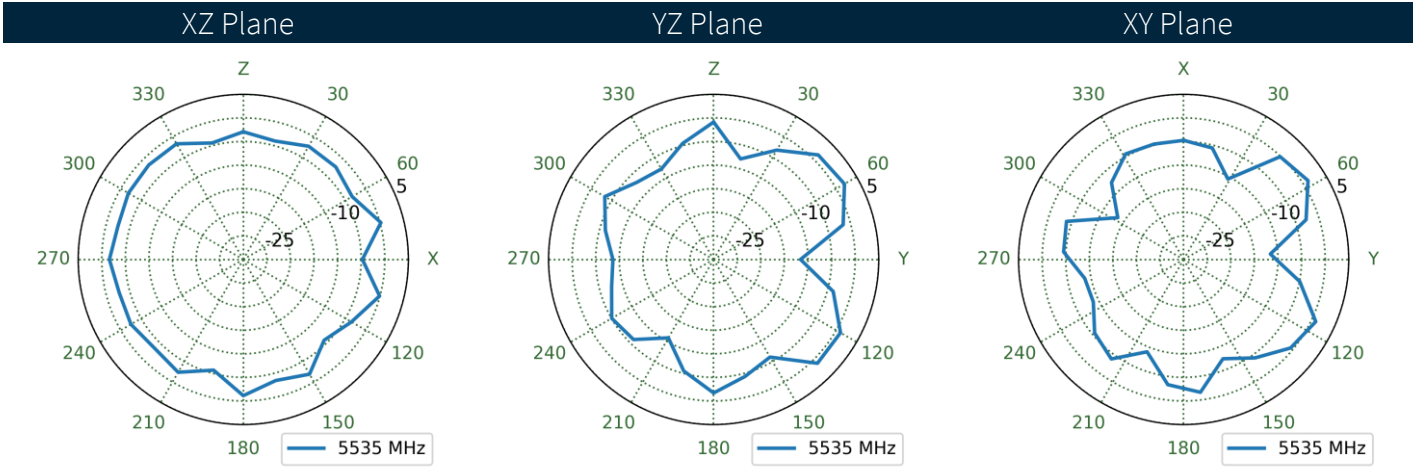
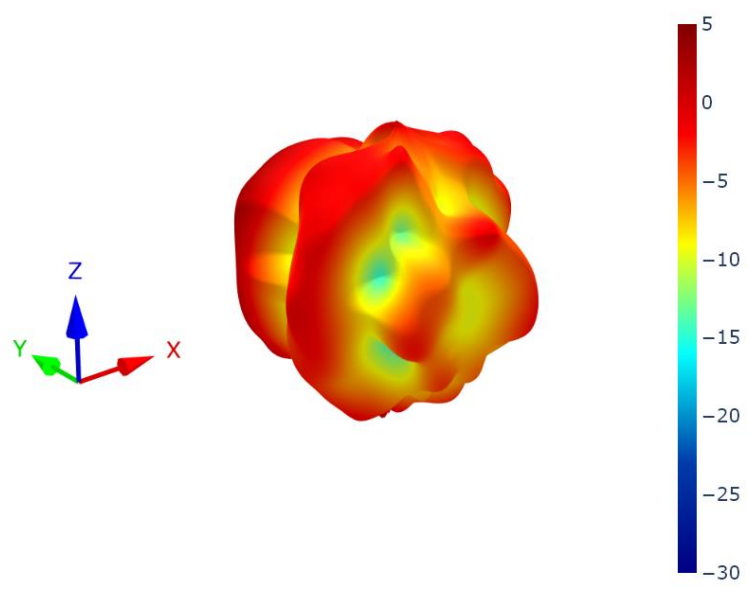

5. Mechanical Drawing

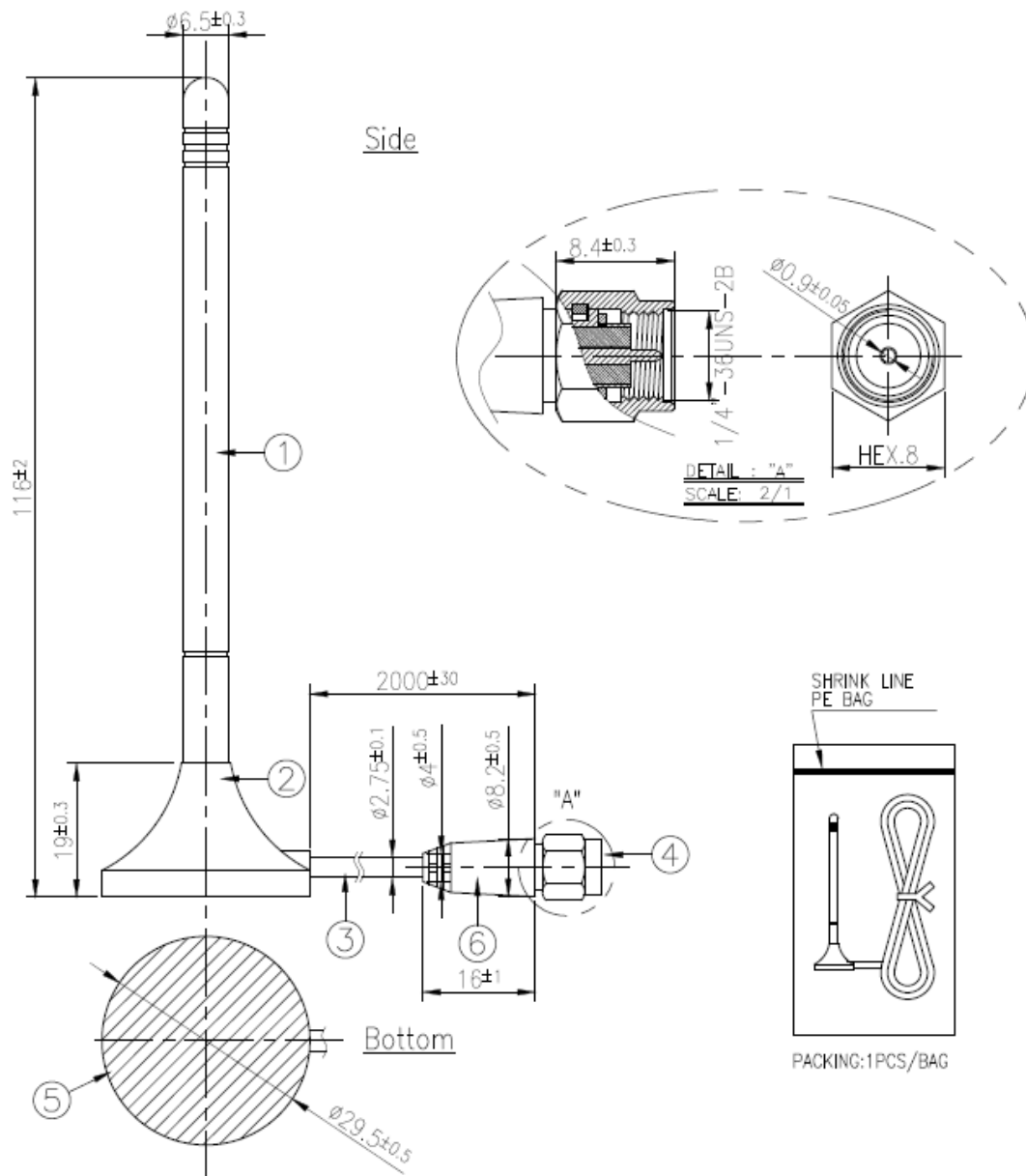

NOTE:
1. Sticker Area.

	Name	P/N	Material	Finish	QTY
1	GA.107 Antenna Housing	000111J040002A	TPU	Black	1
2	Holder	000111J050002A	ABS	Black	1
3	RG174 Coaxial Cable	301315C000000A	PVC	Black	1
4	SMA(M)	200211J000002A	Brass	Au Plated	1
5	Sticker	001011J130002A	Polyster	Silver	1
	Strain Rel			Black	1

6. Packaging

1 pcs GA.107.201111 per PE Bag
 PE Bag Dimensions - 100*180mm
 Weight - 39g

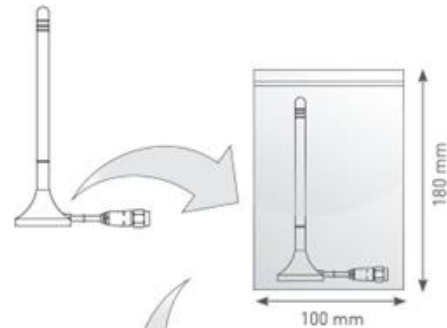

50 PE Bags per Large PE Bag
 50 pcs GA.107.201111 per Large PE Bag
 Large PE Dimensions - 360*520mm
 Weight - 1.95kg

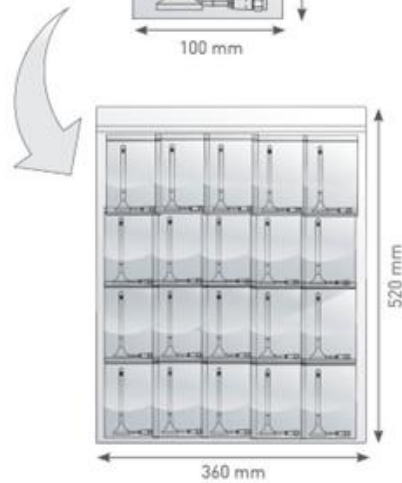

6 Large PE bags per carton
 300 pcs GA.107.201111 per carton
 Carton Dimensions - 430*380*280mm
 Weight - 12.6kg

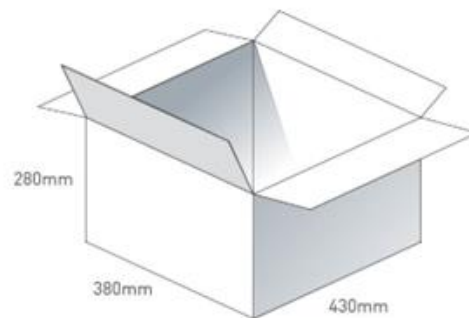

Pallet Dimensions 1140mm*860m*1270mm
 24 Cartons per Pallet
 6 Cartons per layer
 4 Layers

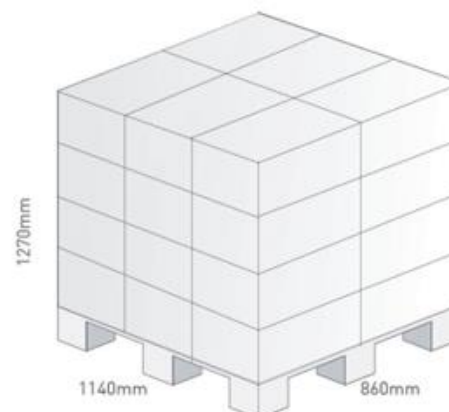

7. Magnetic Pull Force (Kilogram-Force (kgf))

Distance (mm)	0	0.1	0.2	0.3	0.4	0.5	0.6	0.7	0.8	0.9	1
Pull force (kgf)	0	1.37	1.61	1.85	1.9	1.92	1.64	1.42	1.28	1.15	1.06
Distance (mm)	1.1	1.2	1.3	1.4	1.5	1.6	1.7	1.8	1.9	2	2.1
Pull force (kgf)	0.98	0.92	0.86	0.82	0.76	0.74	0.7	0.68	0.64	0.62	0.6
Distance (mm)	2.2	2.3	2.4	2.5	2.6	2.7	2.8	2.9	3	3.1	3.2
Pull force (kgf)	0.58	0.56	0.54	0.52	0.52	0.5	0.49	0.47	0.46	0.45	0.44
Distance (mm)	3.3	3.4	3.5	3.6	3.7	3.8	3.9	4	4.1	4.2	4.3
Pull force (kgf)	0.44	0.42	0.42	0.42	0.4	0.4	0.4	0.4	0.38	0.36	0.36
Distance (mm)	4.4	4.5	4.6	4.7	4.8	4.9	5				
Pull force (kgf)	0.36	0.36	0.36	0.34	0.35	0.34	0.34				

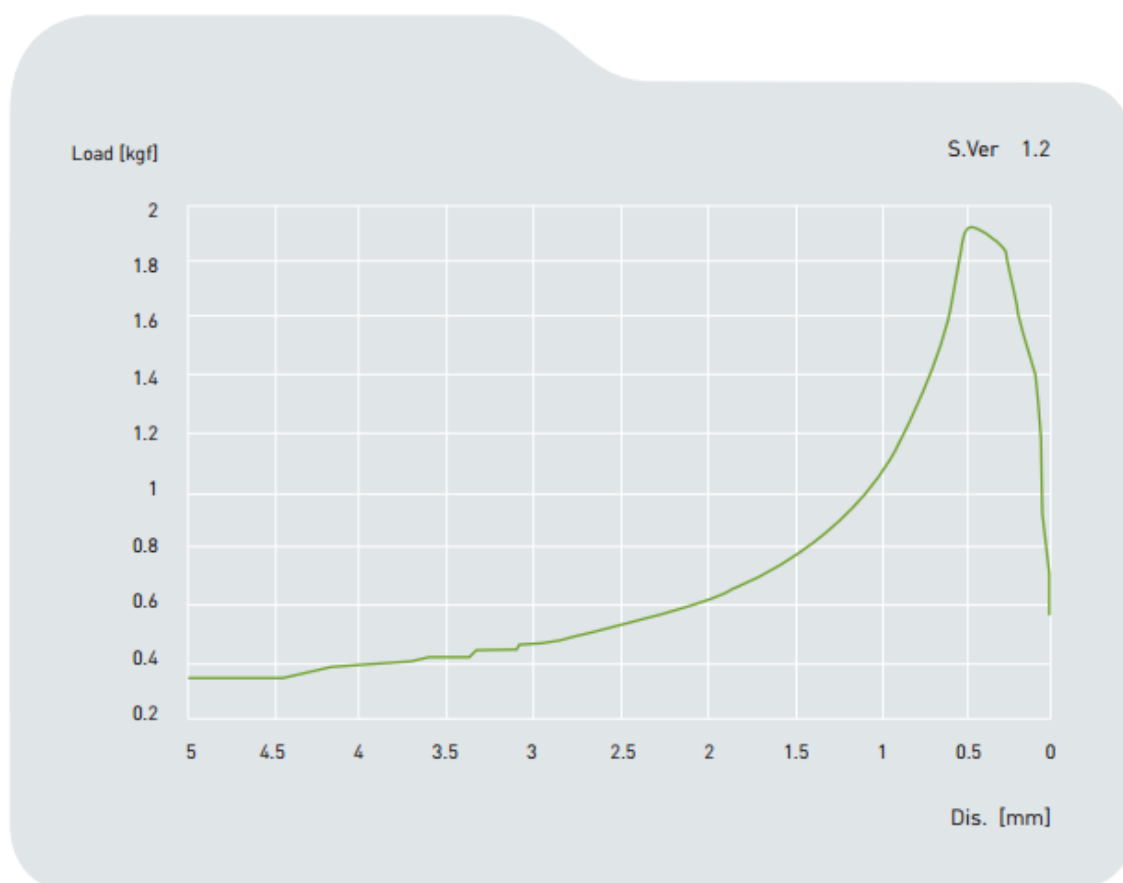

Changelog for the datasheet

SPE-12-8-046 – GA.107.201111

Revision: K (Current Version)

Date:	2023-06-16
Changes:	Updated Specification Updated Radiation Patterns
Changes Made by:	Aswin Biju

Previous Revisions

Revision: J

Date:	2017-07-05
Changes:	Updated as per PCN-16-8-046-B
Changes Made by:	Andy Mahoney

Revision: E

Date:	2013-04-17
Changes:	
Changes Made by:	Unknown Author

Revision: I

Date:	2016-08-23
Changes:	Updated drawing
Changes Made by:	Andy Mahoney

Revision: D

Date:	2013-11-28
Changes:	
Changes Made by:	Unknown Author

Revision: H

Date:	2016-06-22
Changes:	Updated Qty per Carton
Changes Made by:	Aine Doyle

Revision: C

Date:	2012-09-13
Changes:	
Changes Made by:	Unknown Author

Revision: G

Date:	2016-02-18
Changes:	Amended Packaging
Changes Made by:	Aine Doyle

Revision: B

Date:	2012-08-21
Changes:	
Changes Made by:	Unknown Author

Revision: F

Date:	2016-02-03
Changes:	Added in weight, torque and packaging
Changes Made by:	Aine Doyle

Revision: A (First Release)

Date:	2012-04-30
Notes:	
Author:	Unknown Author



www.taoglas.com



Looking for pricing, stock, or lifecycle information?

Click below to explore more details on WIN SOURCE:

⊖ [View GA.107.201111](#) on WIN SOURCE

⊖ [Taoglas Limited](#) Information

Optimize Your Supply Chain with WIN SOURCE Solutions

- ✓ Global Sourcing Solution
- ✓ Obsolete Management
- ✓ Cost Control Management
- ✓ Shortage Management
- ✓ Alternative Solution
- ✓ Excess Inventory Management