

IR2302(s) & (PbF)

Absolute Maximum Ratings

Absolute maximum ratings indicate sustained limits beyond which damage to the device may occur. All voltage parameters are absolute voltages referenced to COM. The thermal resistance and power dissipation ratings are measured under board mounted and still air conditions.

| Symbol | Definition | Min. | Max. | Units |
|---------------------|--|----------------------|-----------------------|-------|
| V _B | High side floating absolute voltage | -0.3 | 625 | V |
| V _S | High side floating supply offset voltage | V _B - 25 | V _B + 0.3 | |
| V _{HO} | High side floating output voltage | V _S - 0.3 | V _B + 0.3 | |
| V _{CC} | Low side and logic fixed supply voltage | -0.3 | 25 | |
| V _{LO} | Low side output voltage | -0.3 | V _{CC} + 0.3 | |
| V _{IN} | Logic input voltage (IN & \overline{SD}) | COM - 0.3 | V _{CC} + 0.3 | |
| dV _S /dt | Allowable offset supply voltage transient | — | 50 | V/ns |
| P _D | Package power dissipation @ T _A ≤ +25°C (8 Lead PDIP) (8 Lead SOIC) | — — | 1.0 0.625 | W |
| R _{thJA} | Thermal resistance, junction to ambient (8 Lead PDIP) (8 Lead SOIC) | — — | 125 200 | °C/W |
| T _J | Junction temperature | — | 150 | °C |
| T _S | Storage temperature | -50 | 150 | |
| T _L | Lead temperature (soldering, 10 seconds) | — | 300 | |

Recommended Operating Conditions

The input/output logic timing diagram is shown in figure 1. For proper operation the device should be used within the recommended conditions. The V_S offset rating is tested with all supplies biased at 15V differential.

| Symbol | Definition | Min. | Max. | Units |
|-----------------|---|--------------------|---------------------|-------|
| V _B | High side floating supply absolute voltage | V _S + 5 | V _S + 20 | V |
| V _S | High side floating supply offset voltage | Note 1 | 600 | |
| V _{HO} | High side floating output voltage | V _S | V _B | |
| V _{CC} | Low side and logic fixed supply voltage | 5 | 20 | |
| V _{LO} | Low side output voltage | 0 | V _{CC} | |
| V _{IN} | Logic input voltage (IN & \overline{SD}) | COM | V _{CC} | |
| T _A | Ambient temperature | -40 | 150 | °C |

Note 1: Logic operational for V_S of -5V to +600V. Logic state held for V_S of -5V to -V_{BS}. (Please refer to the Design Tip DT97-3 for more details).

Dynamic Electrical Characteristics

$V_{BIAS} (V_{CC}, V_{BS}) = 15V$, $C_L = 1000 \text{ pF}$, and $T_A = 25^\circ\text{C}$ unless otherwise specified.

| Symbol | Definition | Min. | Typ. | Max. | Units | Test Conditions |
|-----------|---|------|------|------|-------|----------------------|
| t_{on} | Turn-on propagation delay | 550 | 750 | 950 | nsec | $V_S = 0V$ |
| t_{off} | Turn-off propagation delay | — | 200 | 280 | | $V_S = 0V$ or $600V$ |
| t_{sd} | Shut-down propagation delay | — | 200 | 280 | | |
| MT | Delay matching, HS & LS turn-on/off | — | 0 | 50 | | |
| t_r | Turn-on rise time | — | 130 | 220 | | $V_S = 0V$ |
| t_f | Turn-off fall time | — | 50 | 80 | | $V_S = 0V$ |
| DT | Deadtime: LO turn-off to HO turn-on(DT_{LO-HO}) & HO turn-off to LO turn-on(DT_{HO-LO}) | 400 | 540 | 680 | | |
| MDT | Deadtime matching = $DT_{LO-HO} - DT_{HO-LO}$ | — | 0 | 60 | | |

Static Electrical Characteristics

$V_{BIAS} (V_{CC}, V_{BS}) = 15V$ and $T_A = 25^\circ\text{C}$ unless otherwise specified. The V_{IL} , V_{IH} and I_{IN} parameters are referenced to COM and are applicable to the respective input leads: IN and \overline{SD} . The V_O , I_O and R_{on} parameters are referenced to COM and are applicable to the respective output leads: HO and LO.

| Symbol | Definition | Min. | Typ. | Max. | Units | Test Conditions |
|----------------------------|--|------|------|------|---------------|-------------------------------------|
| V_{IH} | Logic "1" input voltage for HO & logic "0" for LO | 2.9 | — | — | V | $V_{CC} = 10V$ to $20V$ |
| V_{IL} | Logic "0" input voltage for HO & logic "1" for LO | — | — | 0.8 | | $V_{CC} = 10V$ to $20V$ |
| $V_{SD,TH+}$ | \overline{SD} input positive going threshold | 2.9 | — | — | | $V_{CC} = 10V$ to $20V$ |
| $V_{SD,TH-}$ | \overline{SD} input negative going threshold | — | — | 0.8 | | $V_{CC} = 10V$ to $20V$ |
| V_{OH} | High level output voltage, $V_{BIAS} - V_O$ | — | 0.8 | 1.4 | | $I_O = 20 \text{ mA}$ |
| V_{OL} | Low level output voltage, V_O | — | 0.3 | 0.6 | | $I_O = 20 \text{ mA}$ |
| I_{LK} | Offset supply leakage current | — | — | 50 | μA | $V_B = V_S = 600V$ |
| I_{QBS} | Quiescent V_{BS} supply current | 20 | 60 | 100 | | $V_{IN} = 0V$ or $5V$ |
| I_{QCC} | Quiescent V_{CC} supply current | 0.4 | 1.0 | 1.6 | mA | $V_{IN} = 0V$ or $5V$ |
| I_{IN+} | Logic "1" input bias current | — | 5 | 20 | μA | $IN = 5V, \overline{SD} = 0V$ |
| I_{IN-} | Logic "0" input bias current | — | — | 2 | | $IN = 0V, \overline{SD} = 5V$ |
| V_{CCUV+} V_{BSUV+} | V_{CC} and V_{BS} supply undervoltage positive going threshold | 3.3 | 4.1 | 5 | V | |
| V_{CCUV-} V_{BSUV-} | V_{CC} and V_{BS} supply undervoltage negative going threshold | 3 | 3.8 | 4.7 | | |
| V_{CCUVH} V_{BSUVH} | Hysteresis | 0.1 | 0.3 | — | | |
| I_{O+} | Output high short circuit pulsed current | 120 | 200 | — | mA | $V_O = 0V, PW \leq 10 \mu\text{s}$ |
| I_{O-} | Output low short circuit pulsed current | 250 | 350 | — | | $V_O = 15V, PW \leq 10 \mu\text{s}$ |

Functional Block Diagrams

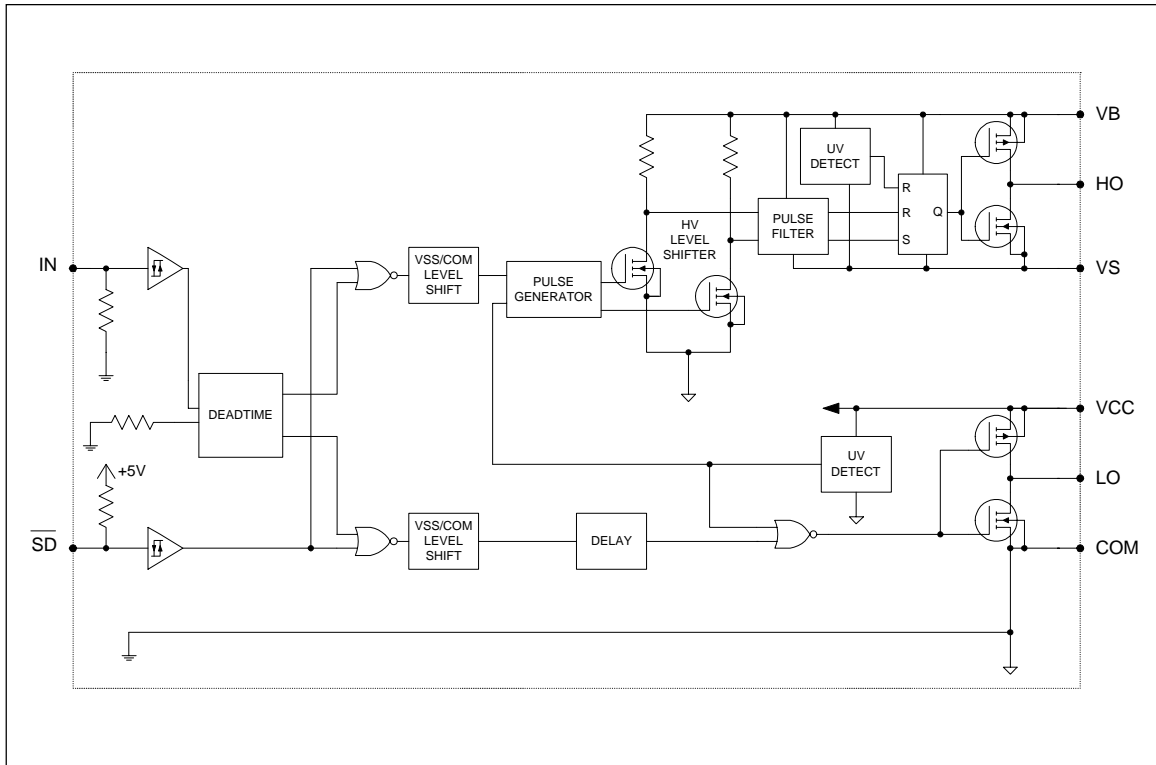

Lead Definitions

| Symbol | Description |
|-----------------|---|
| IN | Logic input for high and low side gate driver outputs (HO and LO), in phase with HO |
| \overline{SD} | Logic input for shutdown |
| V_B | High side floating supply |
| HO | High side gate drive output |
| V_S | High side floating supply return |
| V_{CC} | Low side and logic fixed supply |
| LO | Low side gate drive output |
| COM | Low side return |

Lead Assignments

| | |
|--------------------|--|
| <p>8 Lead PDIP</p> | <p>8 Lead SOIC (Also available LEAD-FREE (PbF))</p> |
| IR2302 | IR2302S |

IR2302(s) & (PbF)

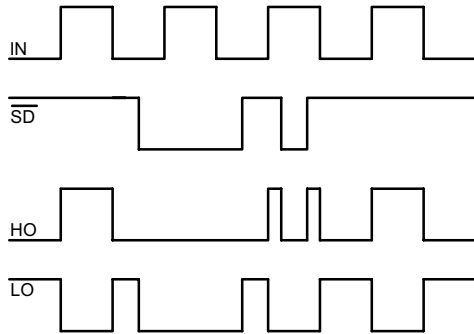

Figure 1. Input/Output Timing Diagram

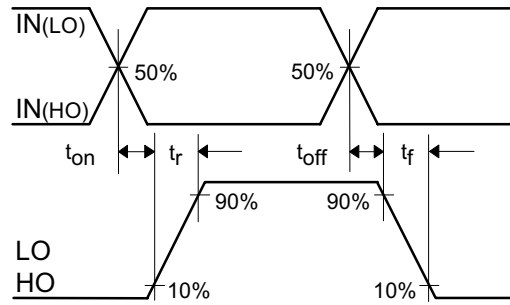

Figure 2. Switching Time Waveform Definitions

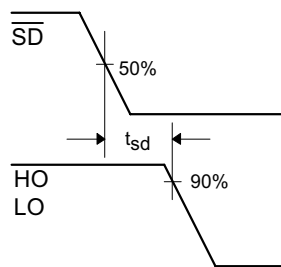

Figure 3. Shutdown Waveform Definitions

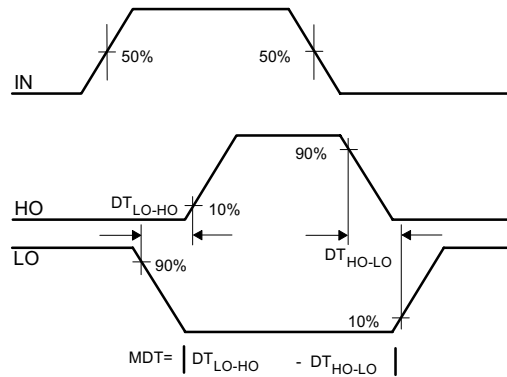

Figure 4. Deadtime Waveform Definitions

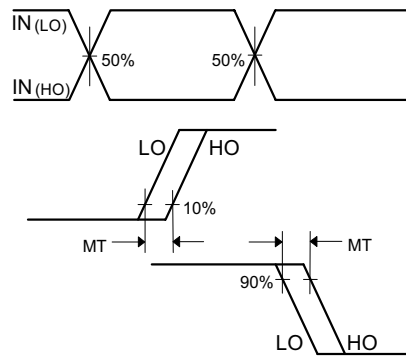

Figure 5. Delay Matching Waveform Definitions

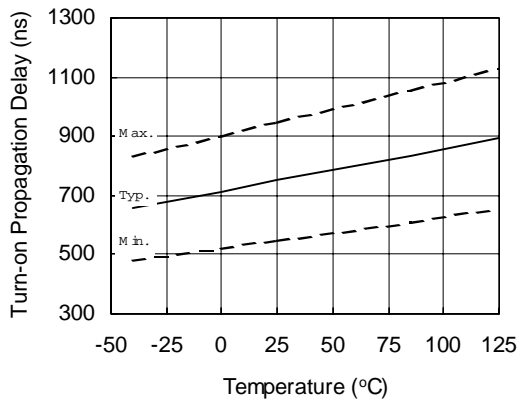

Figure 6A. Turn-on Propagation Delay vs. Temperature

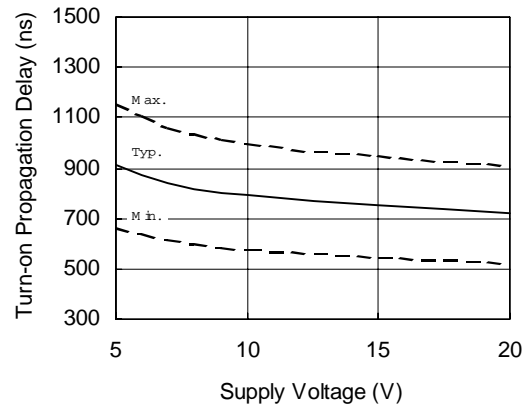

Figure 6B. Turn-on Propagation Delay vs. Supply Voltage

IR2302(s) & (PbF)

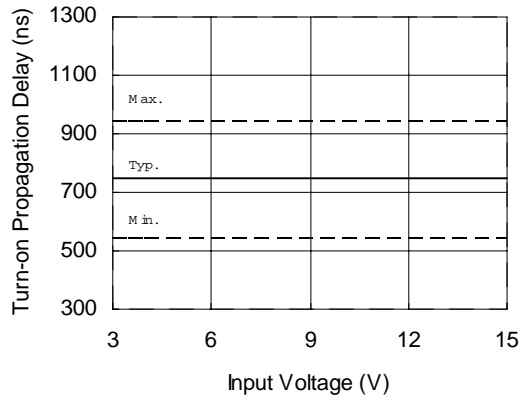

Figure 6C. Turn-on Propagation Delay vs. Input Voltage

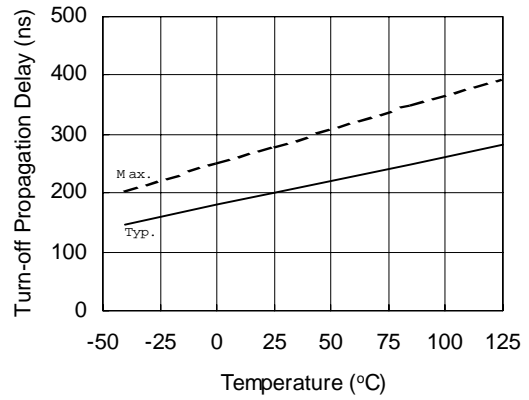

Figure 7A. Turn-off Propagation Delay vs. Temperature

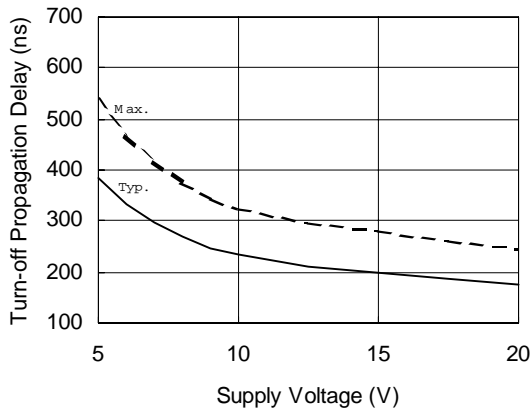

Figure 7B. Turn-off Propagation Delay vs. Supply Voltage

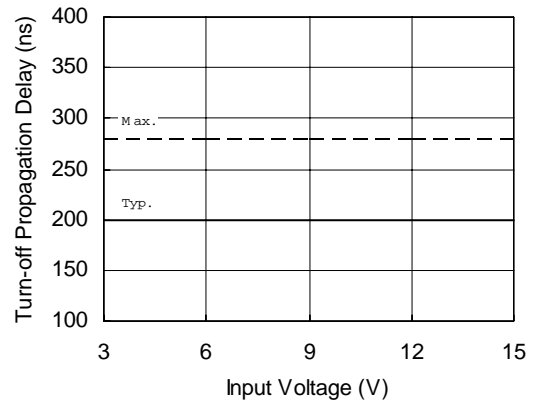

Figure 7C. Turn-off Propagation Delay vs. Input Voltage

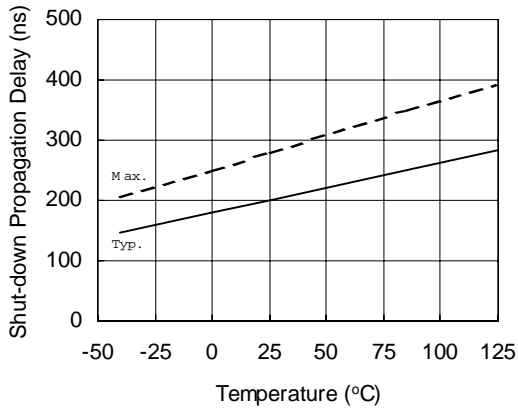

Figure 8A. Shut-down Propagation Delay vs. Temperature

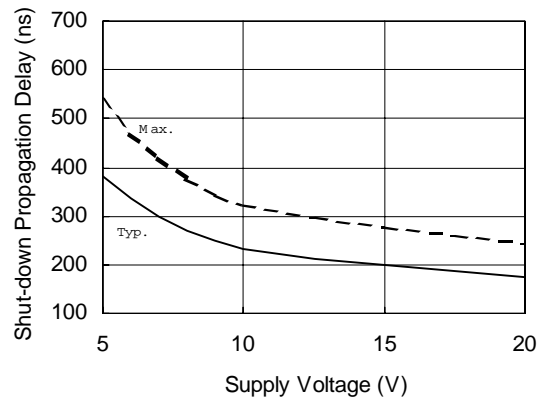

Figure 8B. Shut-down Propagation Delay vs. Supply Voltage

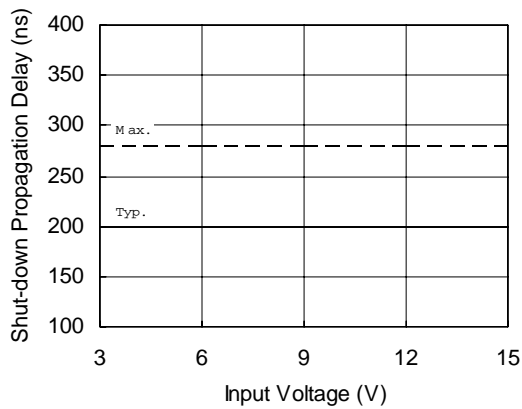

Figure 8C. Shut-down Propagation Delay vs. Input Voltage

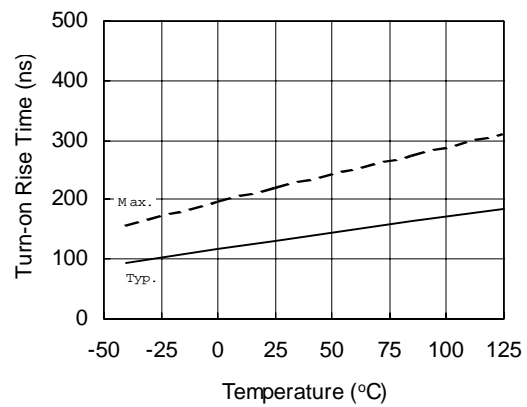

Figure 9A. Turn-on Rise Time vs. Temperature

IR2302(s) & (PbF)

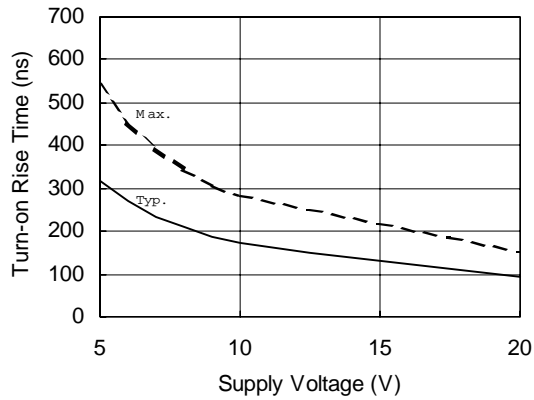

Figure 9B. Turn-on Rise Time vs. Supply Voltage

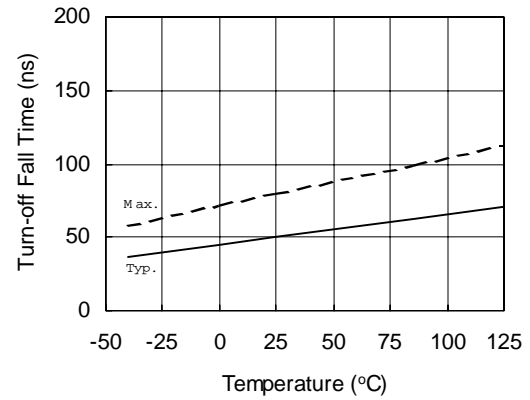

Figure 10A. Turn-off Fall Time vs. Temperature

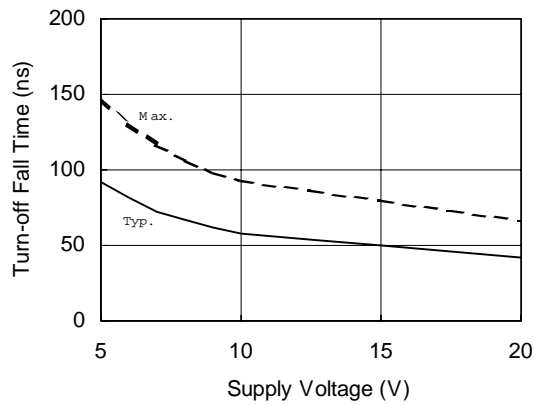

Figure 10B. Turn-off Fall Time vs. Supply Voltage

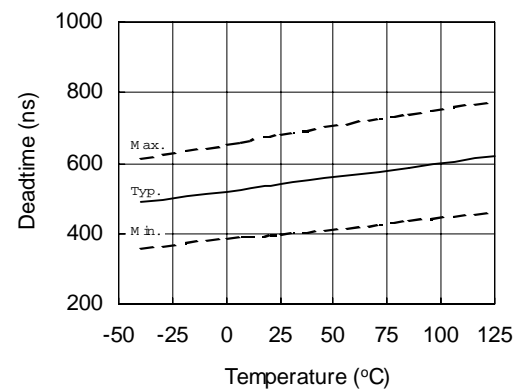

Figure 11A. Deadtime vs. Temperature

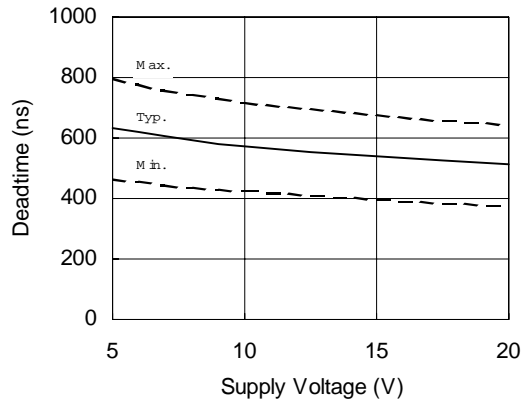

Figure 11B. Deadtime vs. Supply Voltage

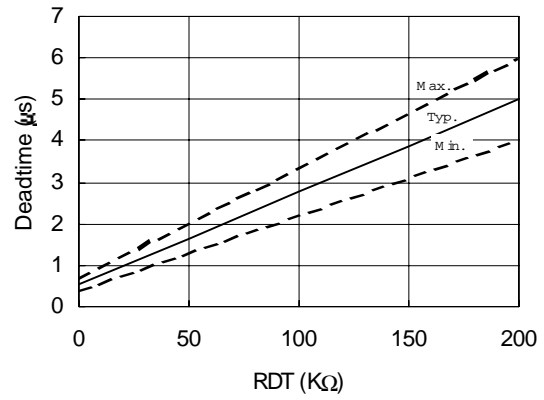

Figure 11C. Deadtime vs. RDT

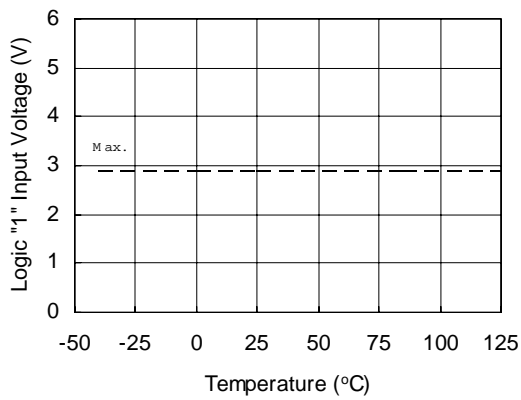

Figure 12A. Logic "1" Input Voltage vs. Temperature

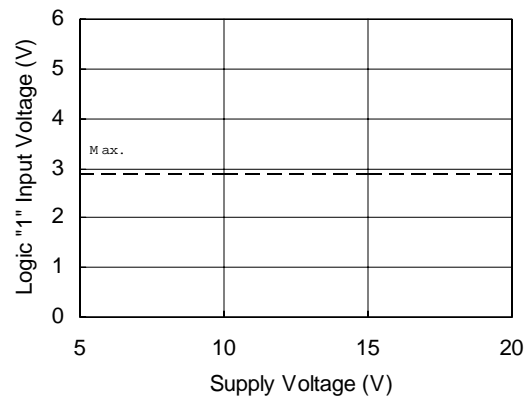

Figure 12B. Logic "1" Input Voltage vs. Supply Voltage

IR2302(s) & (PbF)

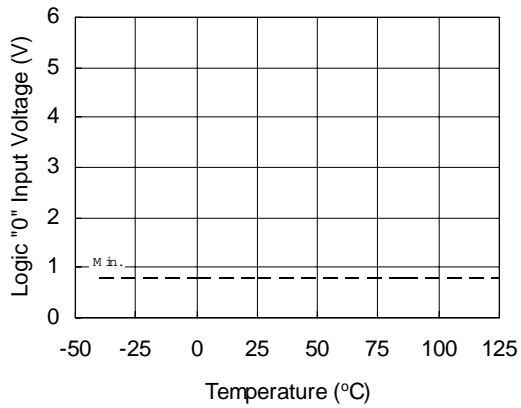

Figure 13A. Logic "0" Input Voltage vs. Temperature

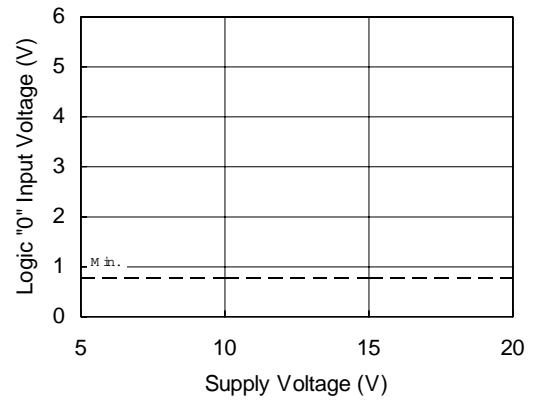

Figure 13B. Logic "0" Input Voltage vs. Supply Voltage

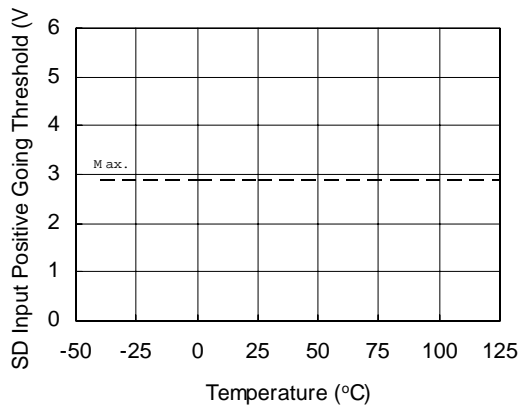

Figure 14A. SD Input Positive Going Threshold vs. Temperature

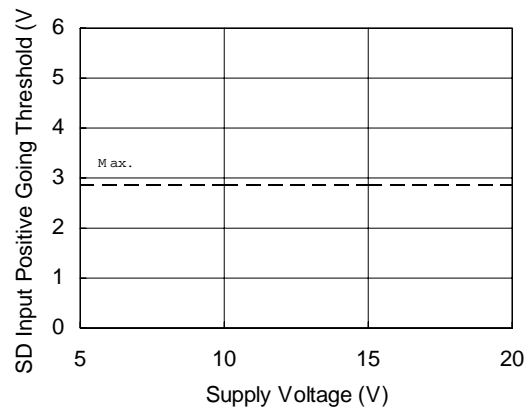

Figure 14B. SD Input Positive Going Threshold vs. Supply Voltage

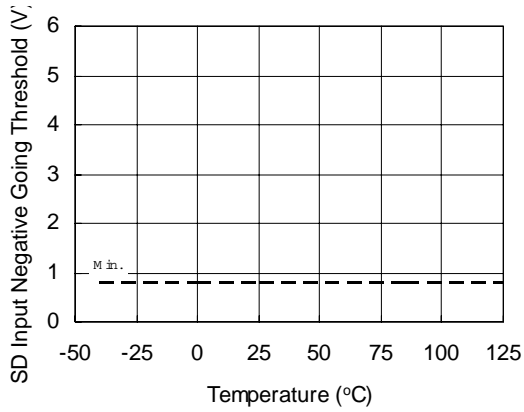

Figure 15A. SD Input Negative Going Threshold vs. Temperature

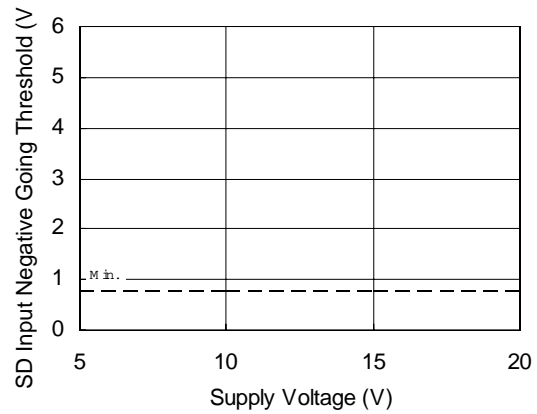

Figure 15B. SD Input Negative Going Threshold vs. Supply Voltage

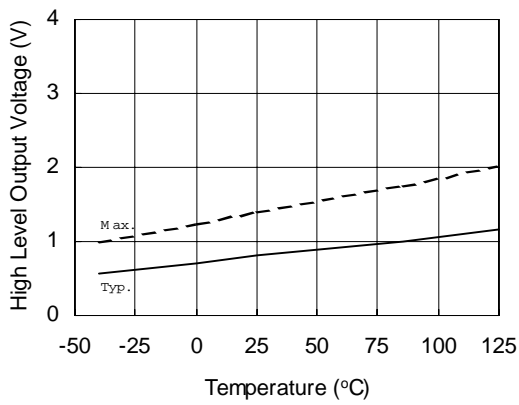

Figure 16A. High Level Output Voltage vs. Temperature

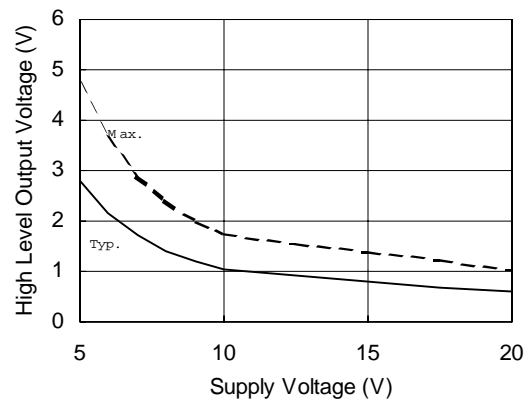

Figure 16B. High Level Output Voltage vs. Supply Voltage

IR2302(s) & (PbF)

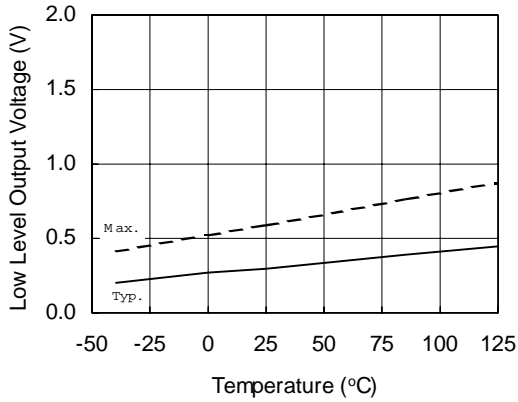

Figure 17A. Low Level Output Voltage vs. Temperature

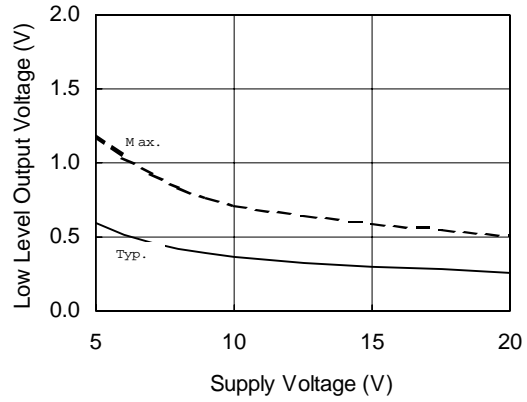

Figure 17B. Low Level Output Voltage vs. Supply Voltage

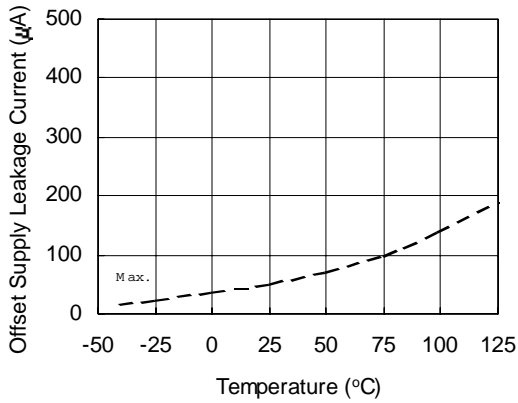

Figure 18A. Offset Supply Leakage Current vs. Temperature

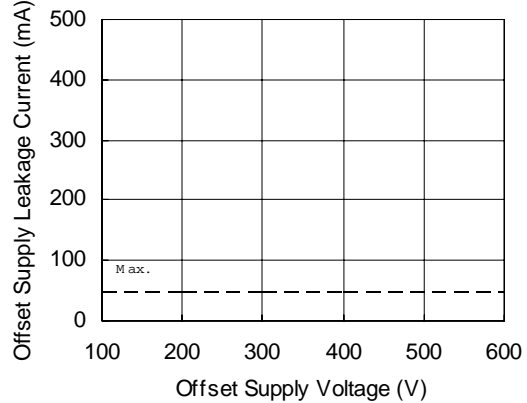

Figure 18B. Offset Supply Leakage Current vs. Offset Supply Voltage

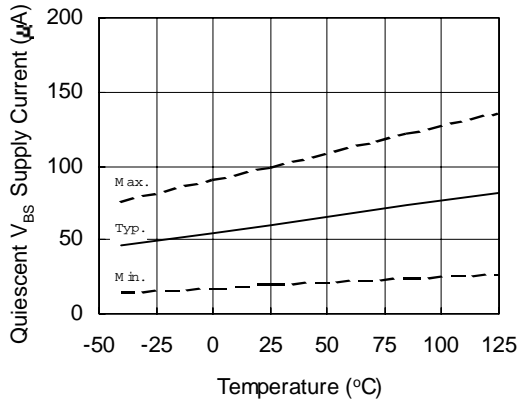

Figure 19A. Quiescent V_{BS} Supply Current vs. Temperature

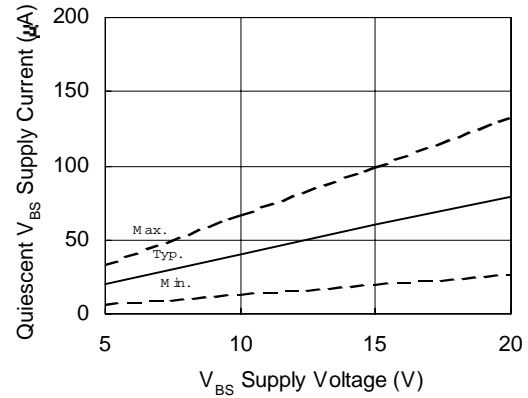

Figure 19B. Quiescent V_{BS} Supply Current vs. V_{BS} Supply Voltage

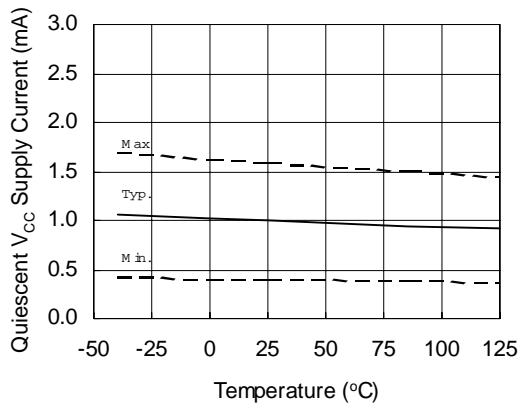

Figure 20A. Quiescent V_{CC} Supply Current vs. Temperature

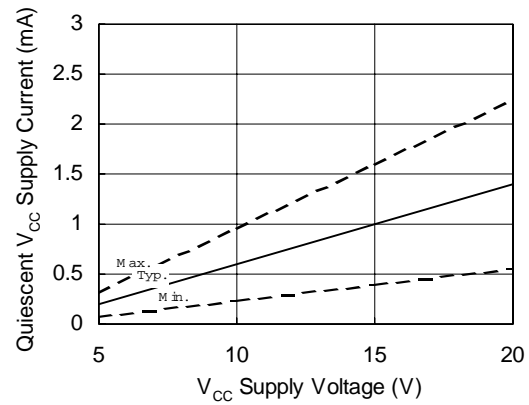

Figure 20B. Quiescent V_{CC} Supply Current vs. V_{CC} Supply Voltage

IR2302(s) & (PbF)

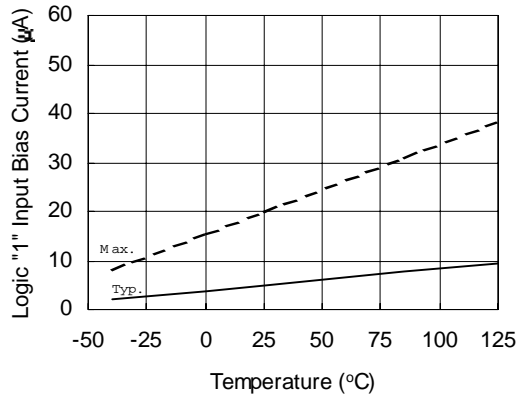

Figure 21A. Logic "1" Input Bias Current vs. Temperature

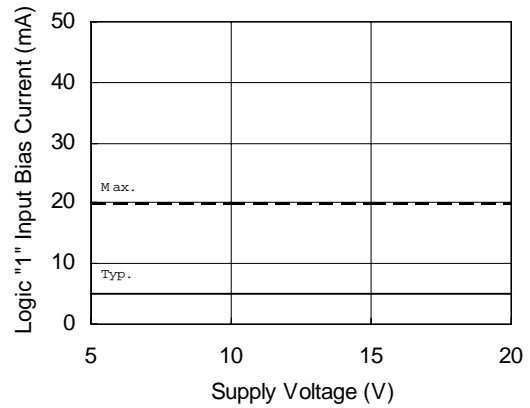

Figure 21B. Logic "1" Input Bias Current vs. Supply Voltage

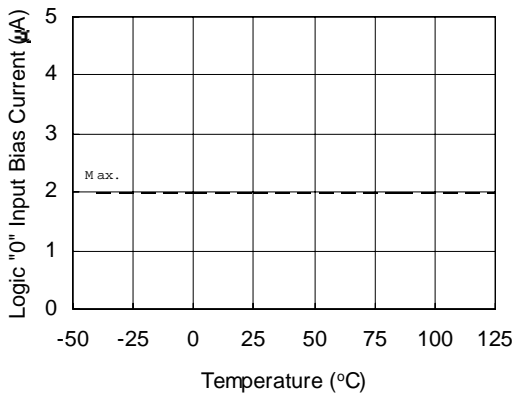

Figure 22A. Logic "0" Input Bias Current vs. Temperature

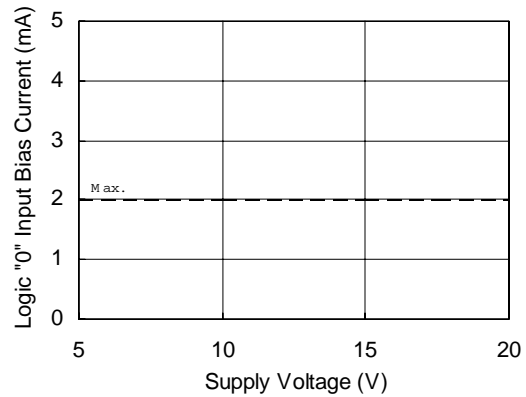

Figure 22B. Logic "0" Input Bias Current vs. Supply Voltage

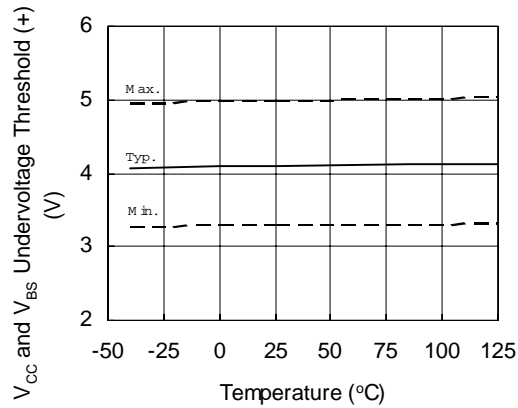

Figure 23. V_{CC} and V_{BS} Undervoltage Threshold (+) vs. Temperature

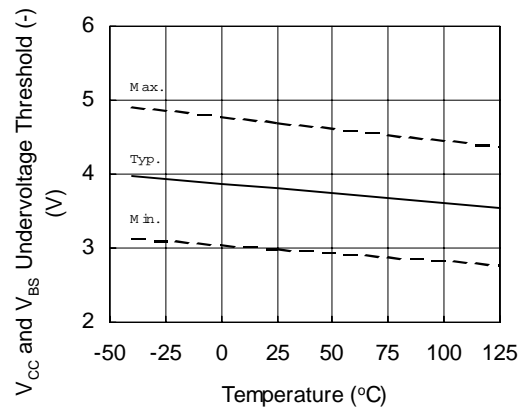

Figure 24. V_{CC} and V_{BS} Undervoltage Threshold (-) vs. Temperature

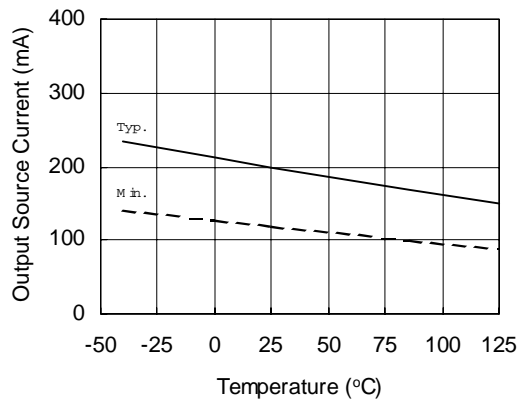

Figure 25A. Output Source Current vs. Temperature

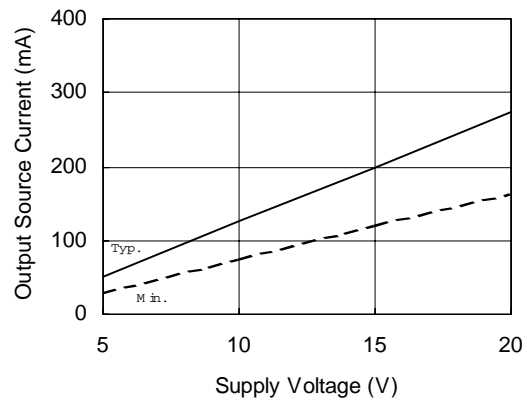

Figure 25B. Output Source Current vs. Supply Voltage

IR2302(s) & (PbF)

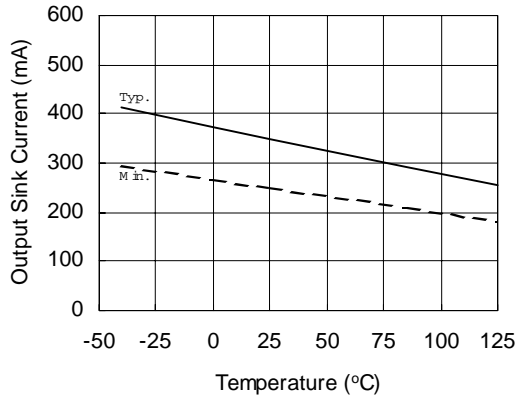

Figure 26A. Output Sink Current vs. Temperature

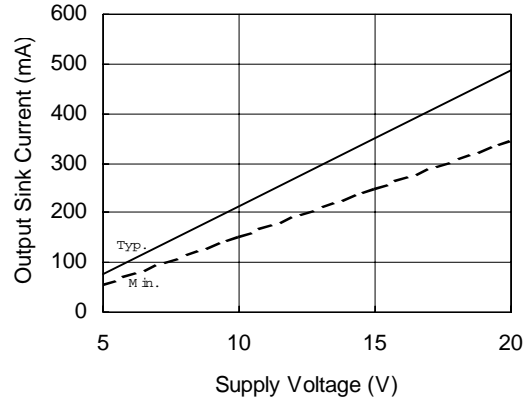

Figure 26B. Output Sink Current vs. Supply Voltage

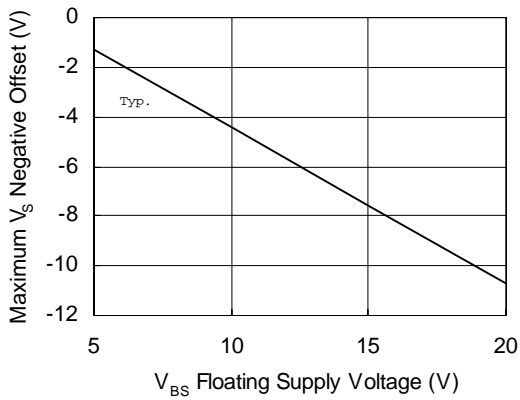
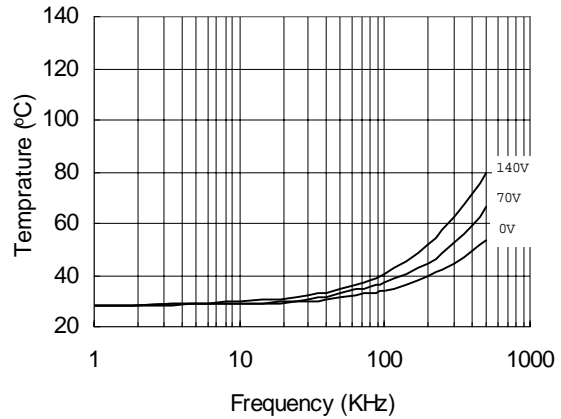

Figure 27. Maximum V_s Negative Offset vs. V_{BS} Floating Supply Voltage



**Figure 28. IR2302 vs. Frequency (IRFBC20),
R_{gate}=33Ω, V_{CC}=15V**

IR2302(s) & (PbF)

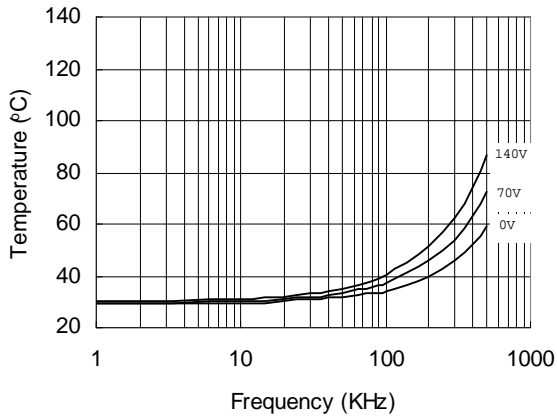

Figure 29. IR2302 vs. Frequency (IRFBC30),
 $R_{gate}=22\Omega$, $V_{CC}=15V$

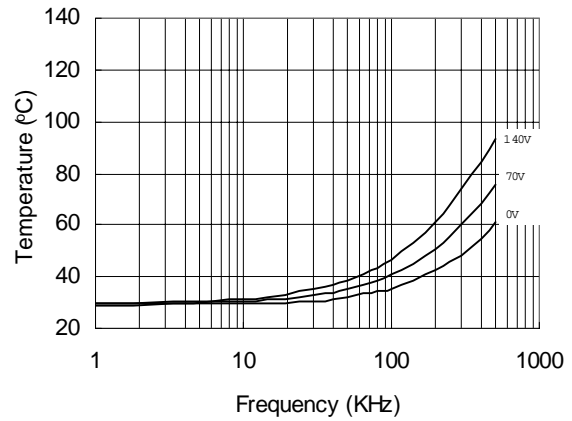

Figure 30. IR2302 vs. Frequency (IRFBC40),
 $R_{gate}=15\Omega$, $V_{CC}=15V$

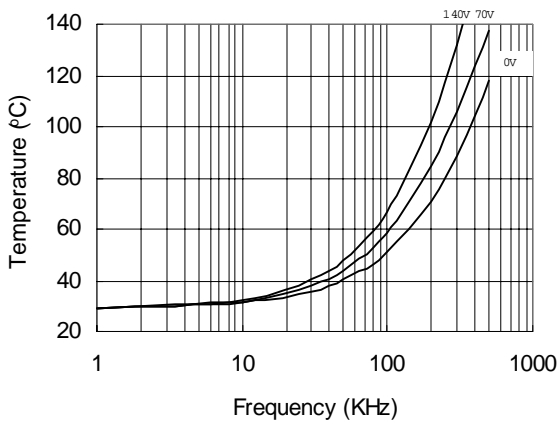

Figure 31. IR2302 vs. Frequency (IRFPE50),
 $R_{gate}=10\Omega$, $V_{CC}=15V$

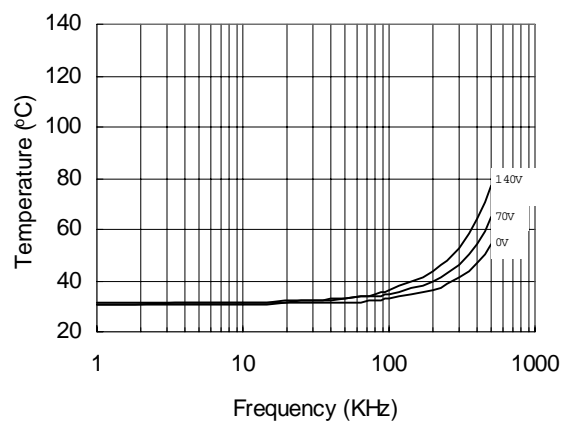

Figure 32. IR2302S vs. Frequency (IRFBC20),
 $R_{gate}=33\Omega$, $V_{CC}=15V$

IR2302(s) & (PbF)

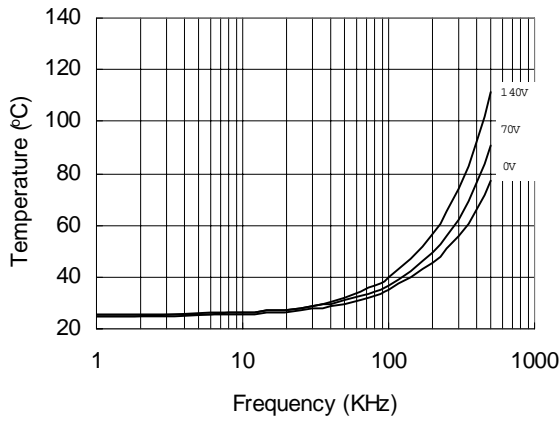

Figure 33. IR2302S vs. Frequency (IRFBC30),
 $R_{gate}=22\Omega$, $V_{CC}=15V$

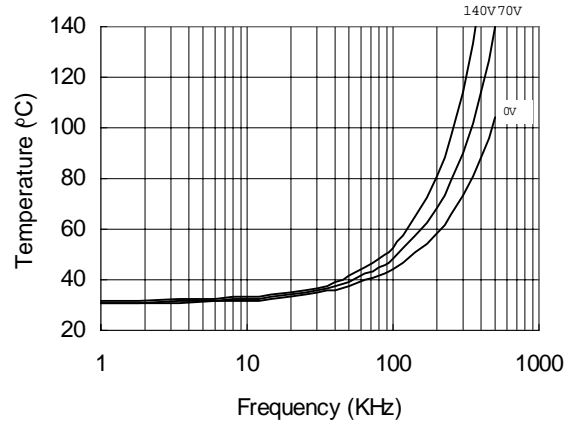

Figure 34. IR2302S vs. Frequency (IRFBC40),
 $R_{gate}=15\Omega$, $V_{CC}=15V$

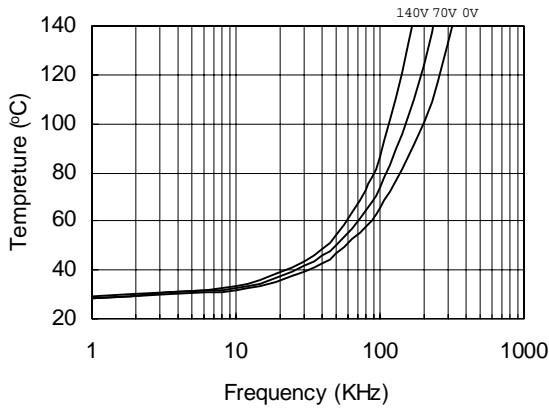
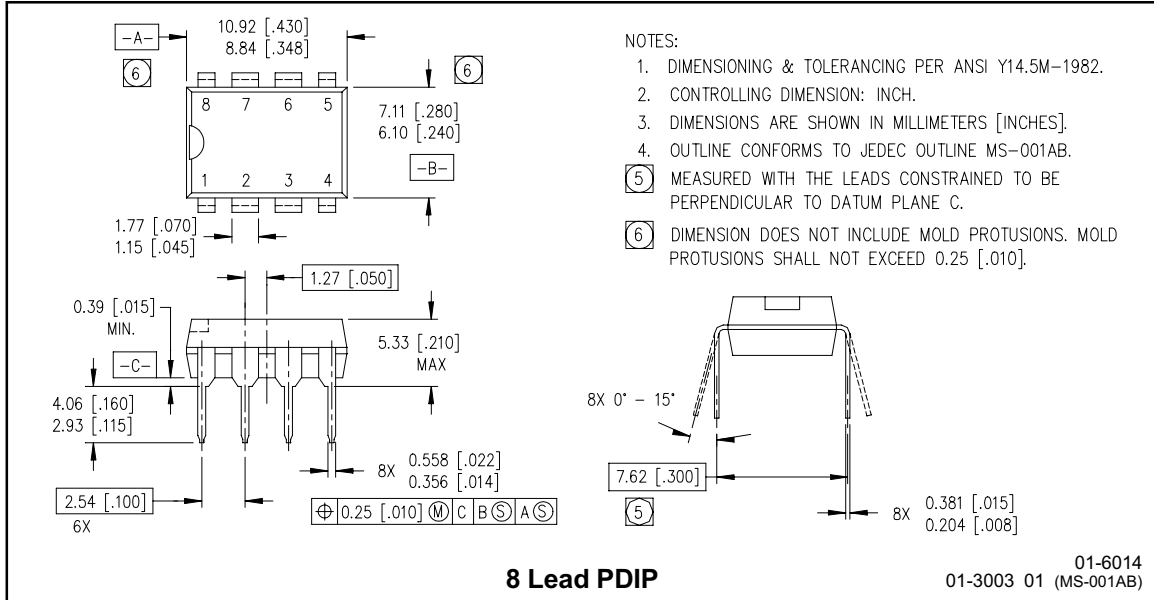
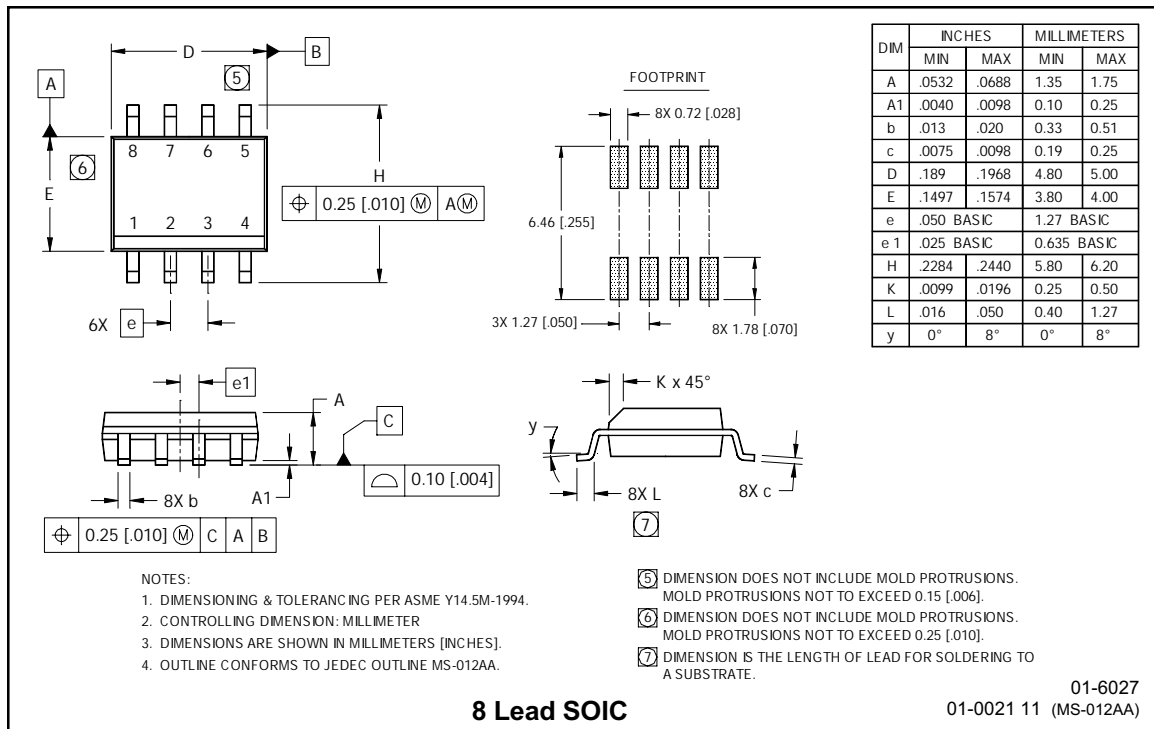

Figure 35. IR2302S vs. Frequency
(IRFPE50), $R_{gate}=10\Omega$, $V_{CC}=15V$

Case Outlines



- NOTES:
1. DIMENSIONING & TOLERANCING PER ANSI Y14.5M-1982.
 2. CONTROLLING DIMENSION: INCH.
 3. DIMENSIONS ARE SHOWN IN MILLIMETERS [INCHES].
 4. OUTLINE CONFORMS TO JEDEC OUTLINE MS-001AB.
 - ⑤ MEASURED WITH THE LEADS CONSTRAINED TO BE PERPENDICULAR TO DATUM PLANE C.
 - ⑥ DIMENSION DOES NOT INCLUDE MOLD PROTUSIONS. MOLD PROTUSIONS SHALL NOT EXCEED 0.25 [.010].



IR2302(s) & (PbF)

LEADFREE PART MARKING INFORMATION

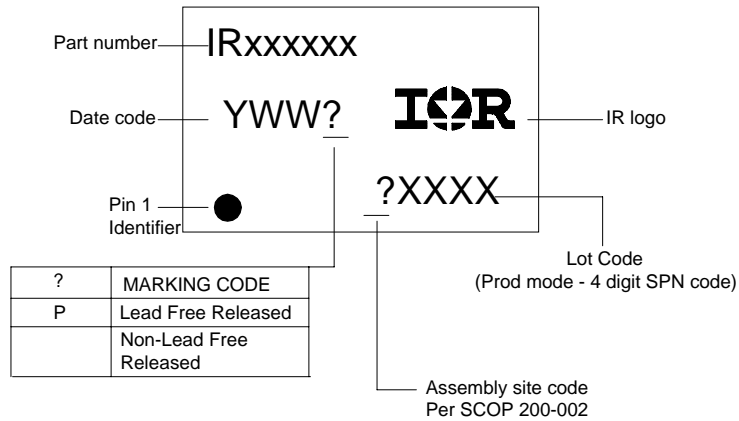

ORDER INFORMATION

Basic Part (Non-Lead Free)

8-Lead PDIP IR2302 order IR2302
8-Lead SOIC IR2302S order IR2302S

Leadfree Part

8-Lead PDIP R2302 not available
8-Lead SOIC IR2302S order IR2302SPbF

Looking for pricing, stock, or lifecycle information?

Click below to explore more details on WIN SOURCE:

 [View IR2302STRPBF](#) on WIN SOURCE

 [Infineon Technologies](#) Information

Optimize Your Supply Chain with WIN SOURCE Solutions

-  Global Sourcing Solution
-  Obsolete Management
-  Cost Control Management
-  Shortage Management
-  Alternative Solution
-  Excess Inventory Management