



**THE DATASHEET OF
PC11.07.0100A**





TAOGLAS®



Datasheet

TheStripe™

Part No:
PC11.07.0100A

Description

Dual-band 2.4 / 5.8 GHz Wi-Fi antenna

Features:

High Efficiency
Dual Band for Wi-Fi®/Bluetooth®/Zigbee® Applications
IPEX MHF Connector (U.FL compatible)
1.13 Mini Co-axial Cable
RoHS & Reach Compliant

1.	Introduction	3
2.	Specification	4
3.	Mechanical Drawing	5
4.	Packaging	6
5.	Antenna Characteristics	7
6.	Radiation Patterns	10
<hr/>		
	Changelog	15

Taoglas makes no warranties based on the accuracy or completeness of the contents of this document and reserves the right to make changes to specifications and product descriptions at any time without notice. Taoglas reserves all rights to this document and the information contained herein. Reproduction, use or disclosure to third parties without express permission is strictly prohibited.

Ireland & USA
ISO 9001:2015
Certified



Taiwan
ISO 9001:2015
Certified



1. Introduction



This miniaturized low profile PCB antenna is based on smart TheStripe™ antenna technology. It consists of a PCB antenna and mini coaxial cable.

Many module manufacturers specify peak gain limits for any antennas that are to be connected to that module. Those peak gain limits are based on free-space conditions. In practice, the peak gain of an antenna tested in free-space can degrade by at least 1 or 2dBi when put inside a device. So ideally you should go for a slightly higher peak gain antenna than mentioned on the module specification to compensate for this effect, giving you better performance.

Upon testing of any of our antennas with your device and a selection of appropriate layout, integration technique, or cable, Taoglas can make sure any of our antennas' peak gain will be below the peak gain limits. Taoglas can then issue a specification and/or report for the selected antenna in your device that will clearly show it complying with the peak gain limits, so you can be assured you are meeting regulatory requirements for that module.

For example, a module manufacturer may state that the antenna must have less than 2dBi peak gain, but you don't need to select an embedded antenna that has a peak gain of less than 2dBi in free-space. This will give you a less optimized solution. It is better to go for a slightly higher free-space peak gain of 3dBi or more if available. Once that antenna gets integrated into your device, performance will degrade below this 2dBi peak gain due to the effects of GND plane, surrounding components, and device housing. If you want to be absolutely sure, contact Taoglas and we will test. Choosing a Taoglas antenna with a higher peak gain than what is specified by the module manufacturer and enlisting our help will ensure you are getting the best performance possible without exceeding the peak gain limits.

Cable and Connectors are customizable please Contact your local Taoglas customer support team to learn more about how this versatile antenna can meet your specific needs.

2. Specification

Electrical									
Band	Frequency (MHz)	Measurement	Efficiency (%)	Average Gain (dB)	Peak Gain (dBi)	Impedance	Polarization	Radiation Pattern	Max. input power
Wi-Fi - 2GHz	2400-2500	2mm ABS	49.2	-3.08	2.20	50 Ω	Linear	Omni directional	2W
		Free Space	54.8	-2.61	3.02				
WiFi - 5GHz	5150-5850	2mm ABS	54.9	-2.60	5.79				
		Free Space	62.2	-2.06	5.49				

Mechanical	
Dimensions	66 x 16 x 0.8 mm
Antenna Body Material	FR4
Cable	Black 100mm 1.13 co-axial
Connector	IPEX MHFI
Weight	2g

Environmental	
Operation Temperature	-40°C to 85°C
Storage Temperature	-40°C to 85°C
Relative Humidity	Non-condensing 65°C 95% RH

3. Mechanical Drawing

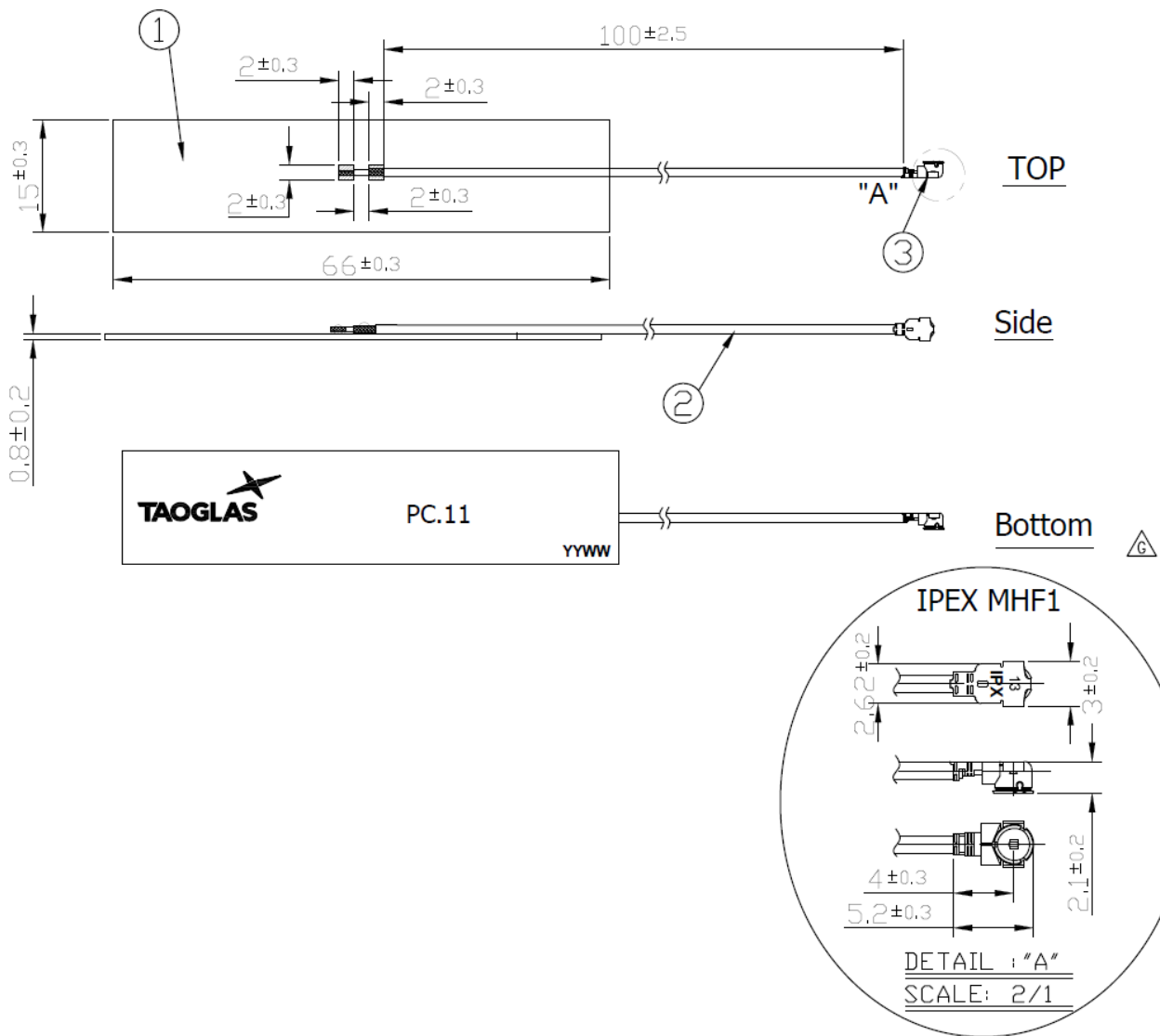

4. Packaging



- 100 PCS / PE bag
- PE bag(mm): 200x320 (Ref)
- Weight (kg): 0.23 ±3%



- 3000 PCS / Carton
- Carton(mm): 320x250x230
- Weight (kg): 7.36 ±3%

5. Antenna Characteristics

5.1 Return Loss

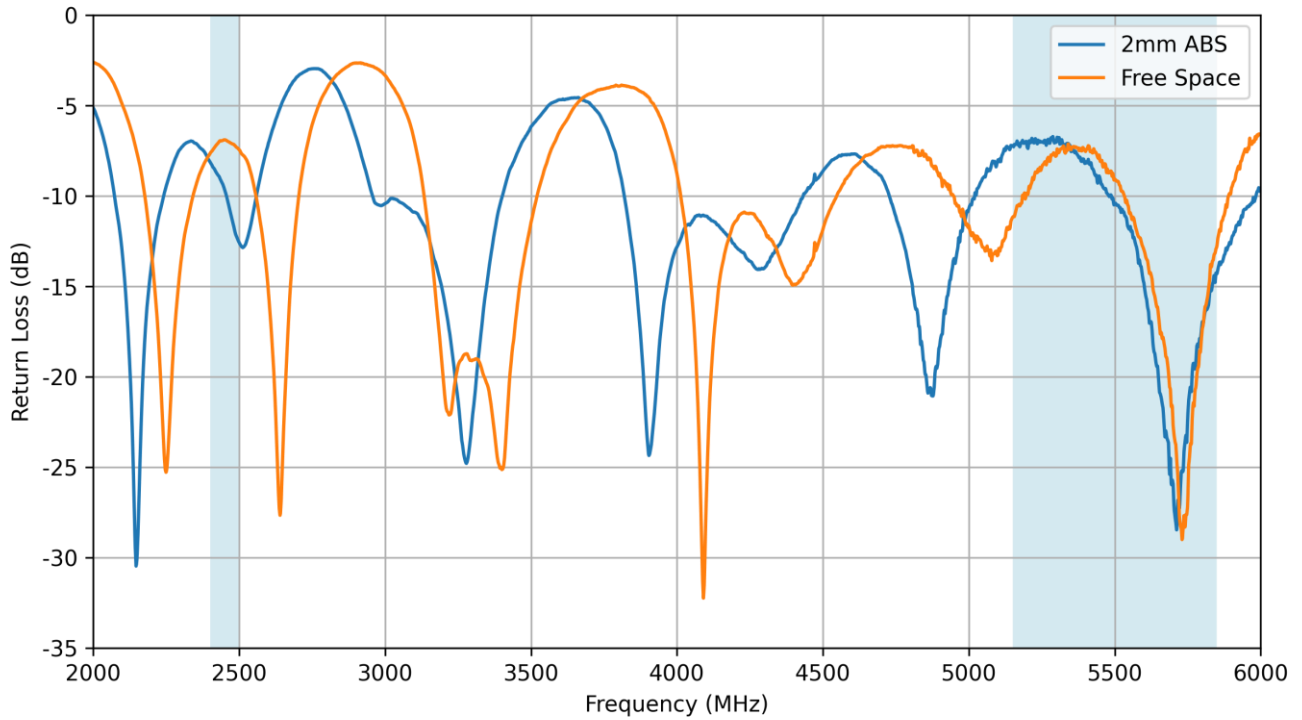

5.2 VSWR

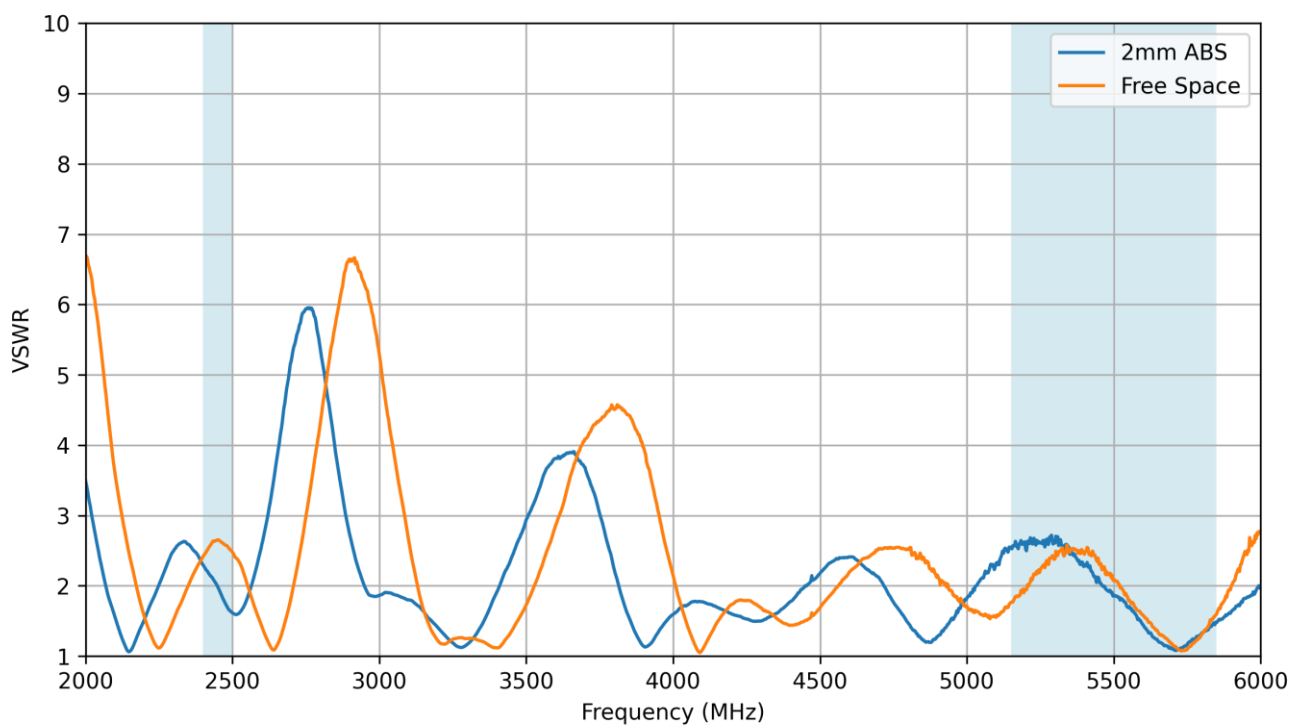

5.3 Efficiency

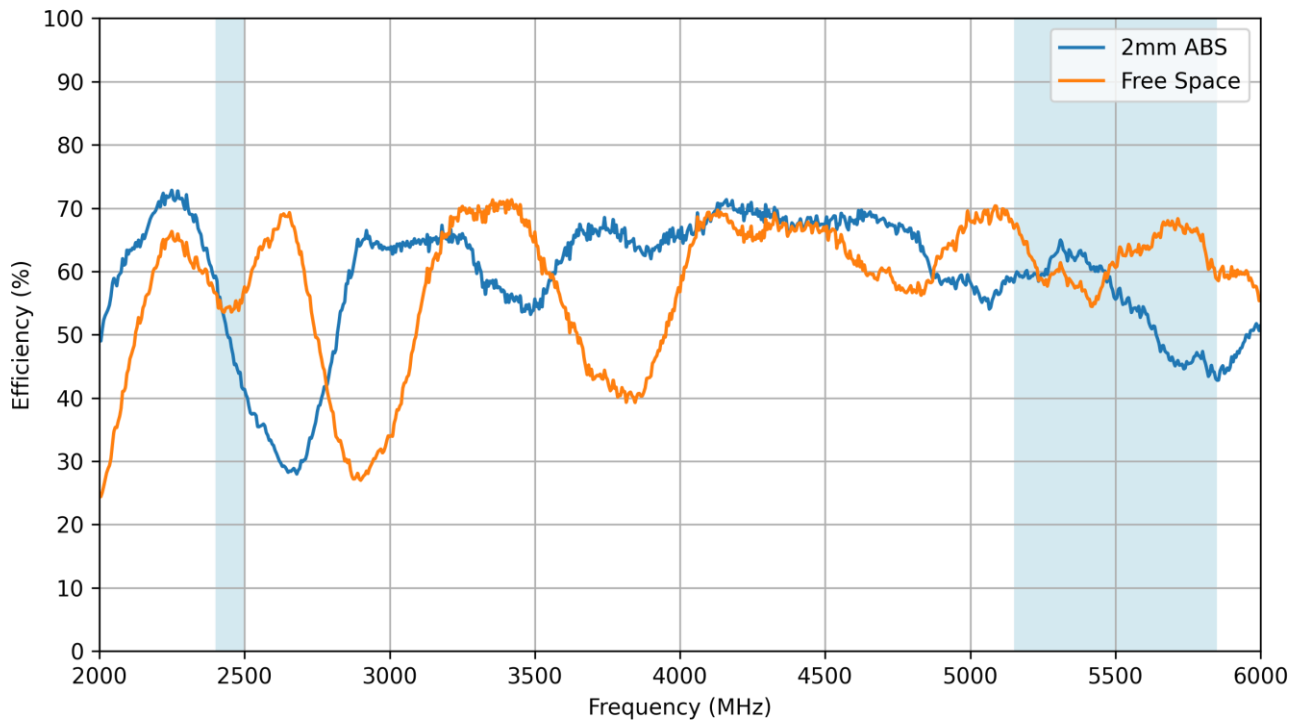

5.4 Average Gain

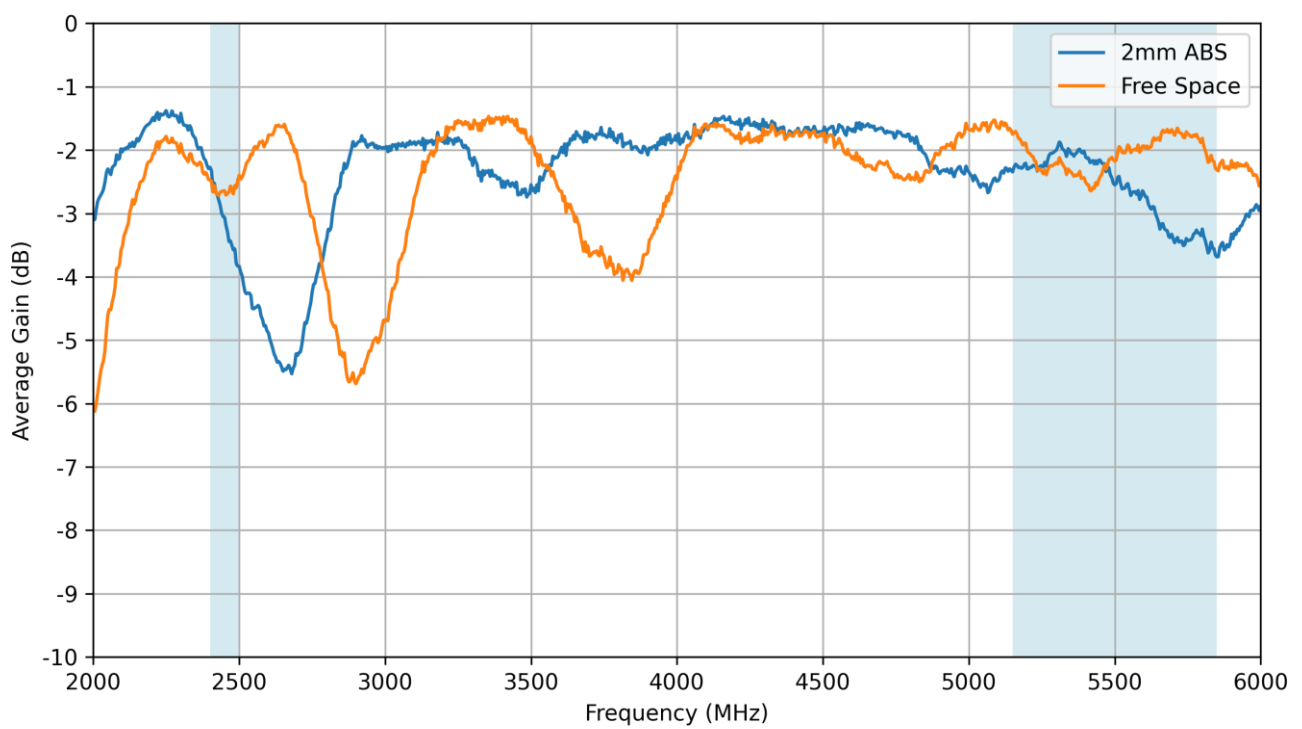

5.5 Peak Gain

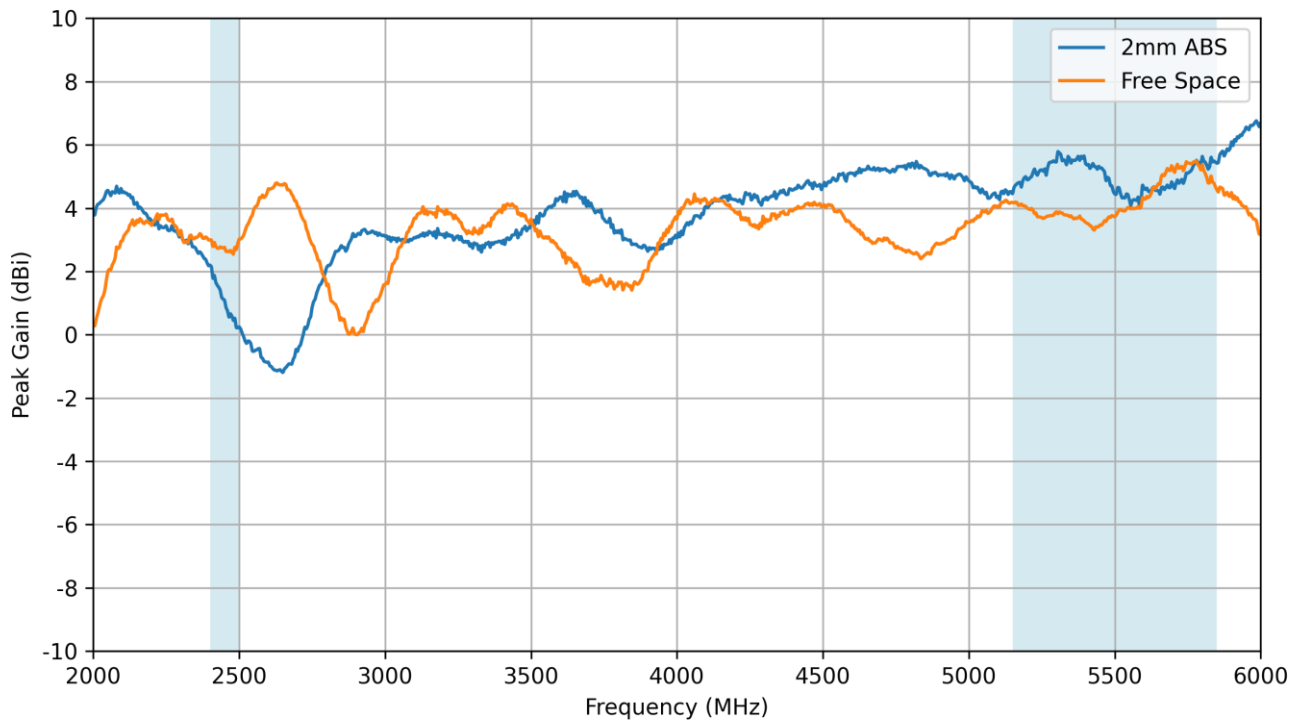

6. Radiation Patterns

6.1 Test Setup

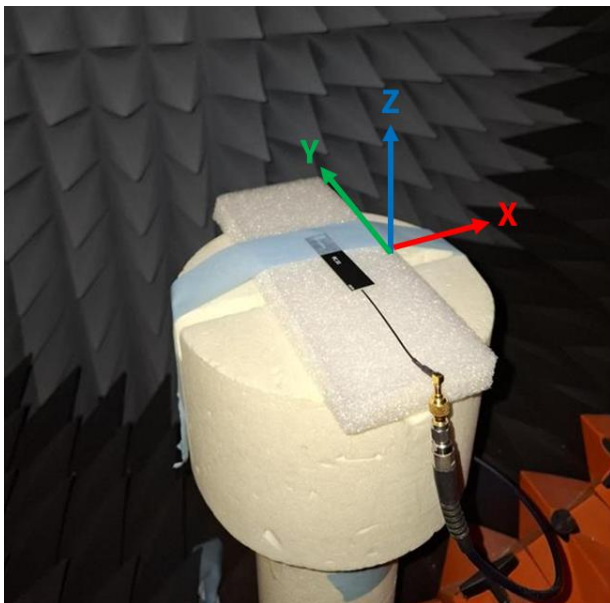
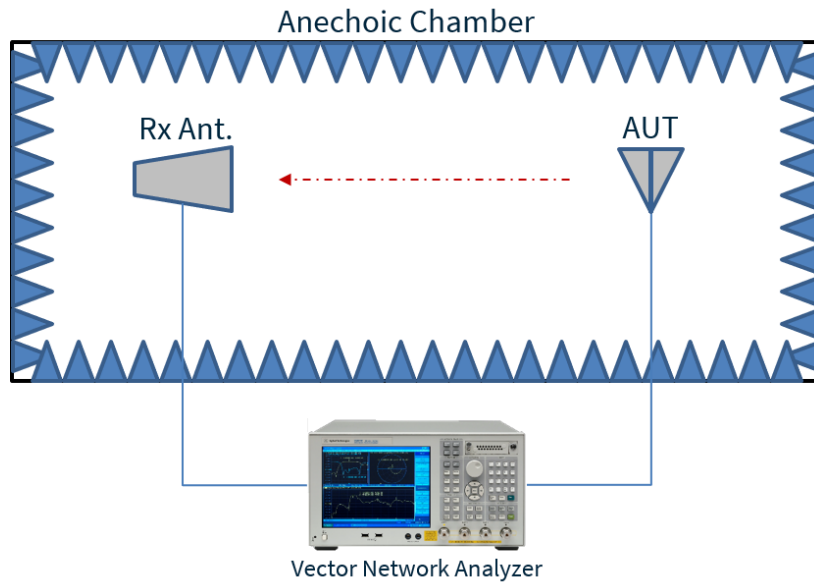

Chamber Setup in Free Space

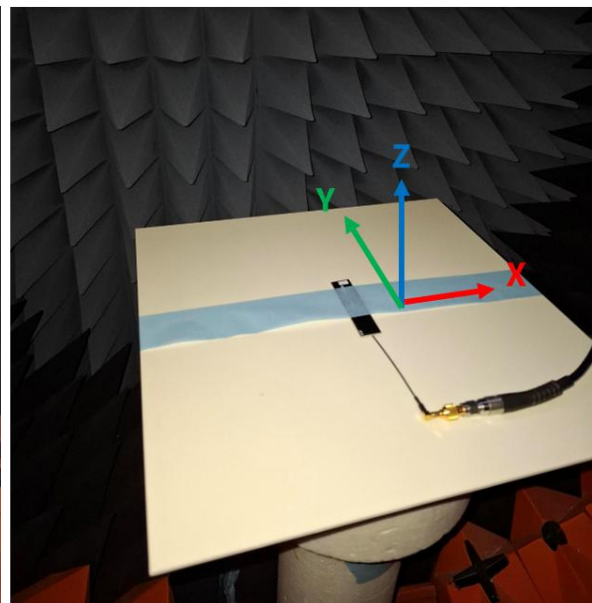

Chamber Setup on 2mm ABS

6.2 2mm ABS Patterns at 2450 MHz

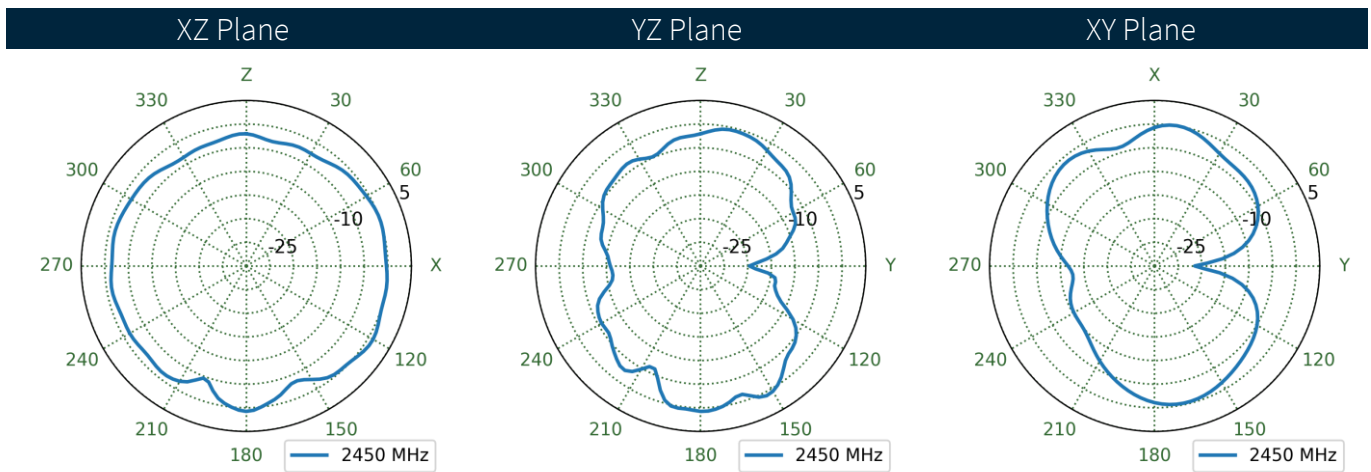
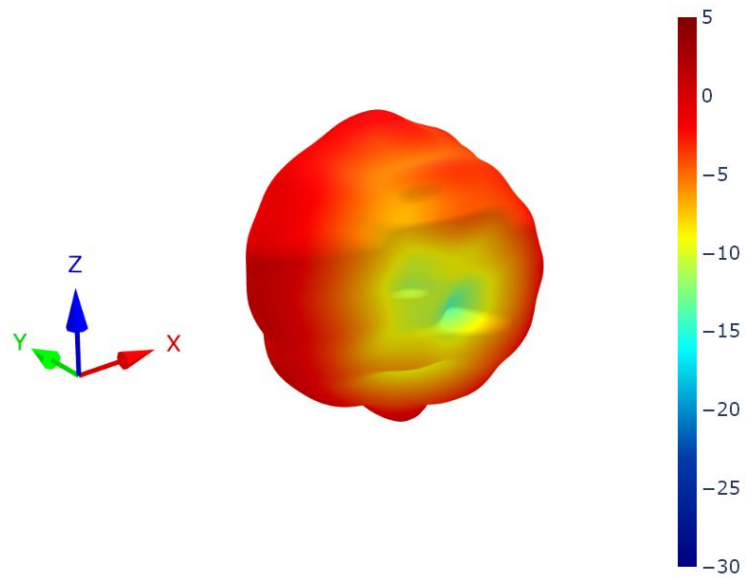

6.3 Free Space Patterns at 2450 MHz

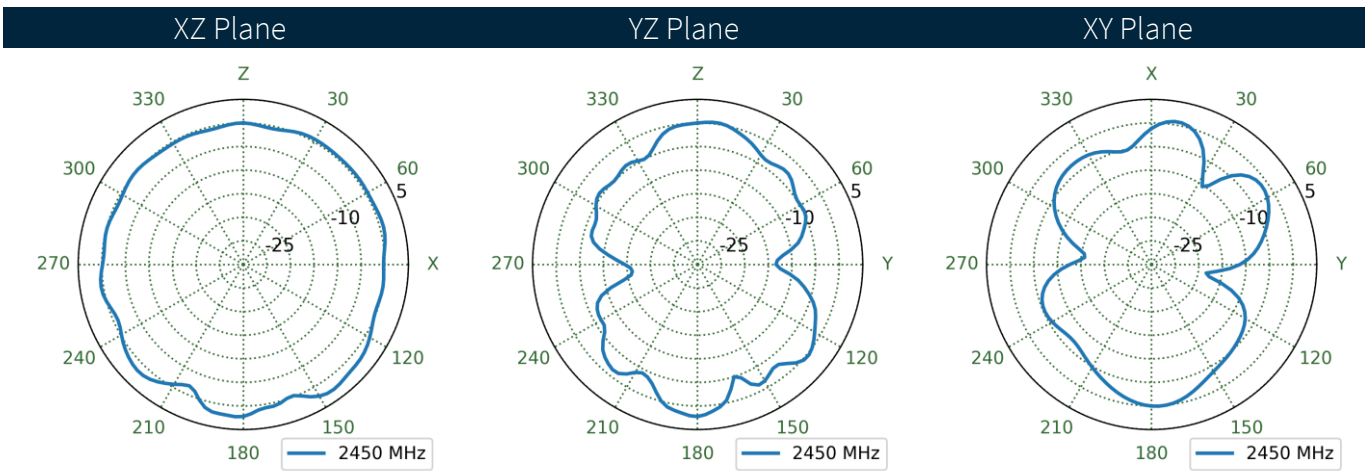
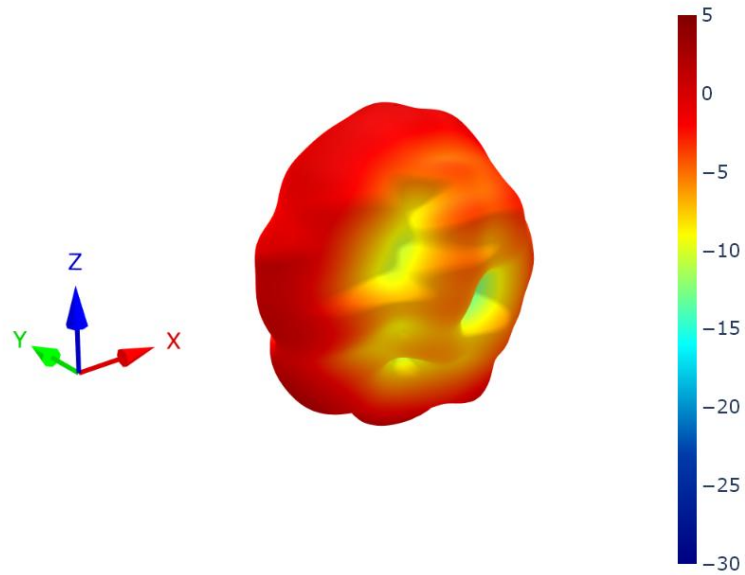

6.4 2mm ABS Patterns at 5500 MHz

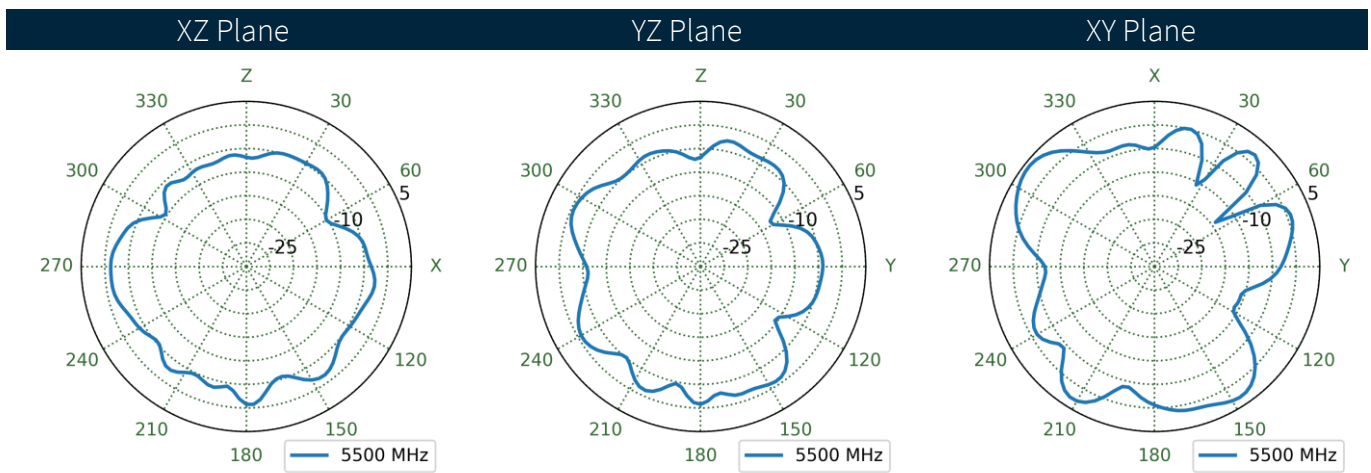
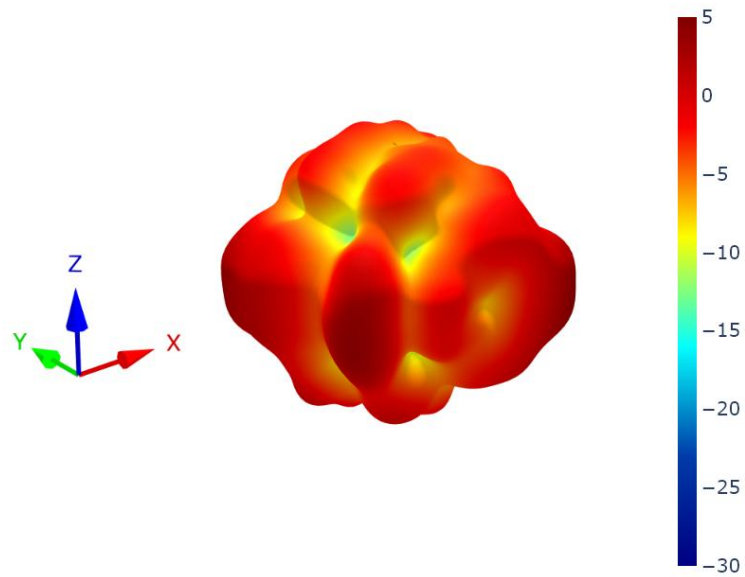

6.5 Free Space Patterns at 5500 MHz

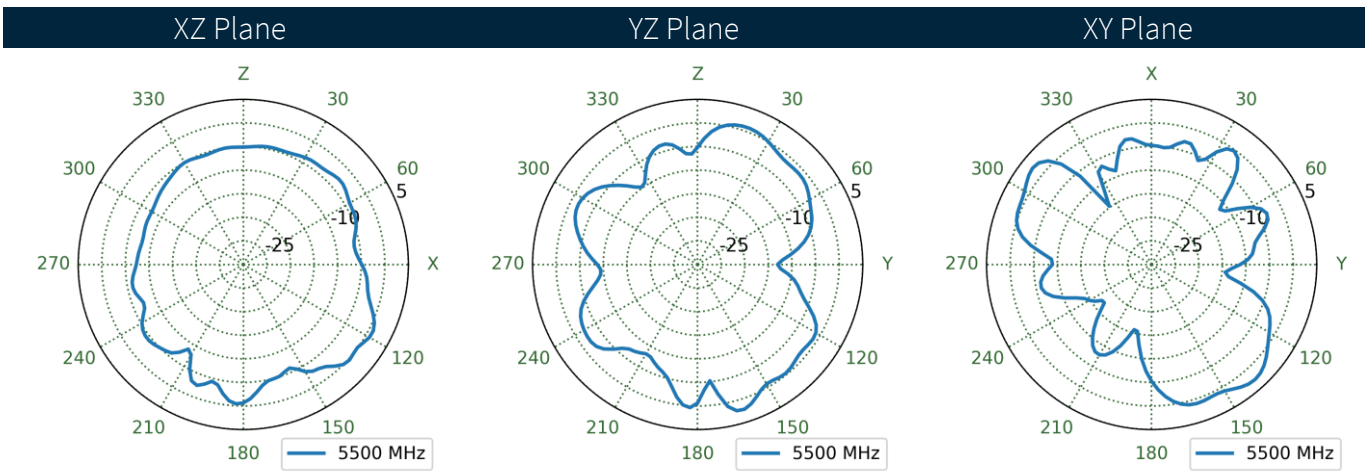
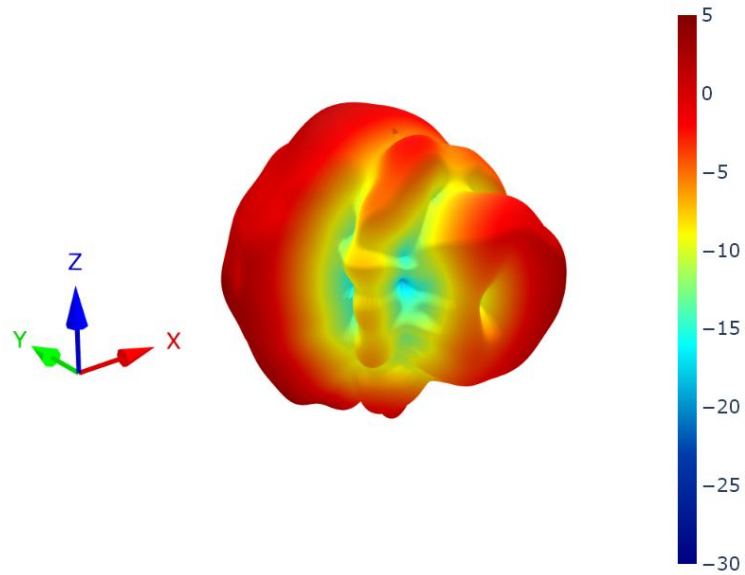

Changelog for the datasheet

SPE-11-8-055 – PC11.07.0100A

Revision: F (Current Version)	
Date:	2025-12-09
Changes:	Full datasheet update.
Changes Made by:	Gary West

Previous Revisions

Revision: E	
Date:	2022-09-26
Changes:	Full datasheet update.
Changes Made by:	Gary West

Revision: D	
Date:	2015-03-04
Changes:	Added note to gain.
Changes Made by:	Aine Doyle

Revision: C	
Date:	2013-02-06
Changes:	
Changes Made by:	Technical Writer

Revision: B	
Date:	2011-07-27
Changes:	
Changes Made by:	Technical Writer

Revision: A (Original First Release)	
Date:	2011-07-11
Notes:	
Author:	Technical Writer



www.taoglas.com



Looking for pricing, stock, or lifecycle information?

Click below to explore more details on WIN SOURCE:

 [View PC11.07.0100A](#) on WIN SOURCE

 [Taoglas Limited](#) Information

Optimize Your Supply Chain with WIN SOURCE Solutions

-  Global Sourcing Solution
-  Obsolete Management
-  Cost Control Management
-  Shortage Management
-  Alternative Solution
-  Excess Inventory Management