

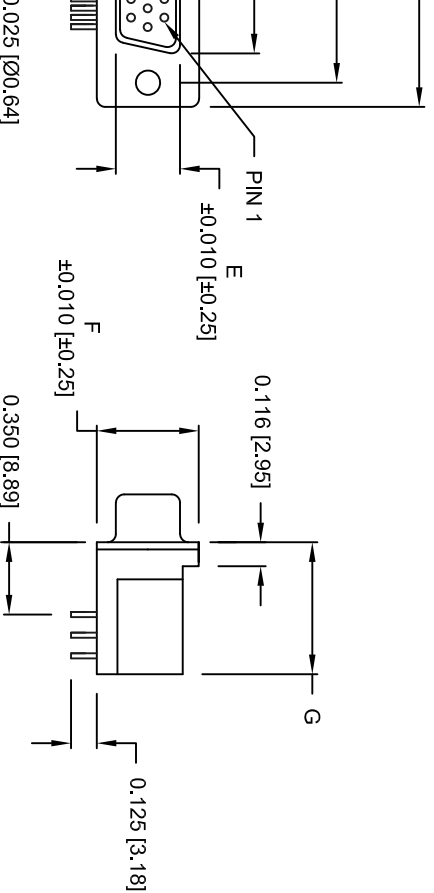

THE DATASHEET OF
181-015-213R561



E - RIGHT ANGLE



DIMENSIONS (IN.)							
No. OF PINS	A	B	C	D	E	F	G
15	1.213	0.984	0.644	0.090	0.311	0.496	0.639
	30.80	24.99	16.34	2.29	7.90	12.60	16.23
26	1.543	1.312	0.966	0.090	0.311	0.496	0.639
	39.19	33.32	24.53	2.29	7.90	12.60	16.23
44	2.087	1.852	1.512	0.090	0.311	0.496	0.639
	53.00	47.04	38.40	2.29	7.90	12.60	16.23
62	2.732	2.500	2.156	0.095	0.311	0.496	0.639
	69.30	63.50	54.76	2.41	7.90	12.60	16.23

181-YYY-213 R YY 1

- SERIES _____
- POSITIONS _____
- 015 _____
- 026 _____
- 044 _____
- 062 _____
- GENDER _____
- 2 = FEMALE
- TERMINATION _____
- 1 = DIP SOLDER
- SHELL PLATING _____
- 3 = NICKEL PLATED
- ROHS COMPLIANT _____
- (HIGH TEMP. PROCESS)
- HARDWARE OPTIONS _____
- 16 = Ø 0.120 HOLE / INSIDE GND STRAPS
- 17 = 4-40 INSERTS / INSIDE GND STRAPS
- 18 = 4-40 SCREWLOCKS / INSIDE GND STRAPS
- 43 = Ø 0.120 HOLE / METAL SHELL
- 45 = 4-40 INSERTS / METAL SHELL
- 48 = 4-40 SCREWLOCKS / METAL SHELL
- 53 = 4-40 INSERTS / BOARDLOCKS
- 55 = Ø 0.120 HOLE / BOARDLOCKS
- 56 = 4-40 SCREWLOCKS / BOARDLOCKS
- 59 = 4-40 4-40 SCREWLOCKS W/ LOCKWASHER & BOARDLOCKS
- PLATING OPTIONS _____
- 1 = GOLD FLASH
- 2 = 30u" GOLD PLATING

- 3 AMPS
- 15 MilliOhms Max.
- 1,000 MEGOhms Min. at 500 VDC
- 1,000 VAC FOR 1 MINUTE
- 250 VAC
- 55°C TO +105°C

- SPOCC, NICKEL PLATED
- PA9T-BLACK (UL94-0)
- 260°C PROCESS TEMPERATURE
- BRASS, GOLD ENTIRE CONTACT
- COPPER ALLOY, NICKEL PLATED
- SPOCC, TIN PLATED
- ZINC ALLOY, NICKEL PLATED

DO NOT SCALE FROM DRAWING



THESE DRAWINGS AND SPECIFICATIONS ARE THE PROPERTY OF NorComp AND SHALL NOT BE REPRODUCED, COPIED OR USED AS THE BASIS FOR THE MANUFACTURE OR SALE OF APPARATUS WITHOUT WRITTEN PERMISSION.

DRAWN: PAM JENKINS DATE: 03-15-05

SCALE: NTS SHEET 1 OF 3 REV 17

DWG NO. 181-YYY-213 RYY1

COMPLIANT

NorComp

GLE - FEMALE

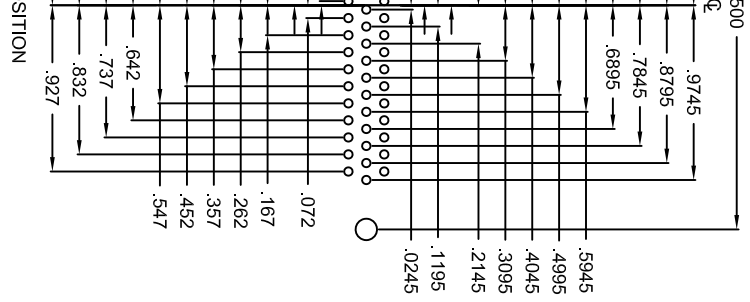
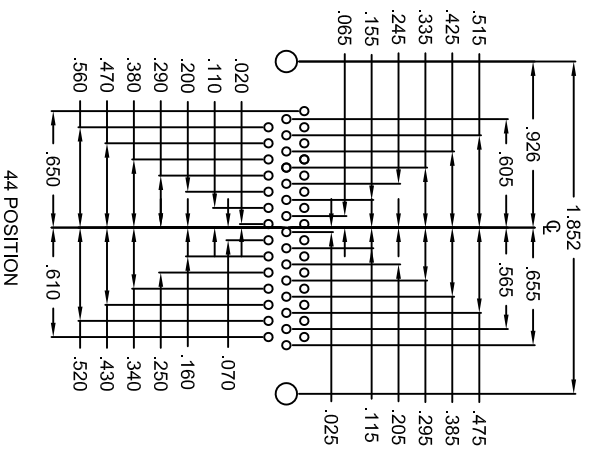
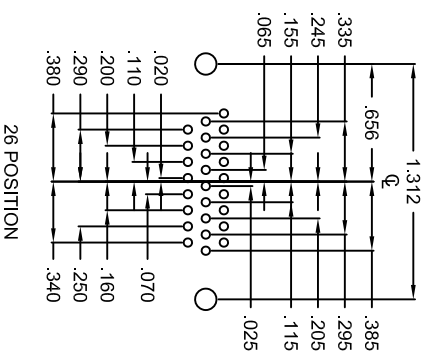
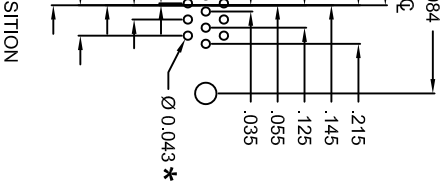

HOLE PATTERN SHOWN
ARE FOR FEMALE

UNITS = inch

* TYP.
SUGGESTED SIZE
MAY NOT BE SUITABLE FOR ALL APPLICATIONS

DO NOT SCALE FROM DRAWING

	THESE DRAWINGS AND SPECIFICATIONS ARE THE PROPERTY OF NorComp AND SHALL NOT BE REPRODUCED, COPIED OR USED AS THE BASIS FOR THE MANUFACTURE OR SALE OF APPARATUS WITHOUT WRITTEN PERMISSION.		
	DRAWN: PAM JENKINS	DATE: 03-15-05	

<h1>NorComp</h1>	SCALE: NTS	SHEET 2 OF 3	REV 17
	DWG NO. 181-YYY-213RRY1		

WARE OPTIONS

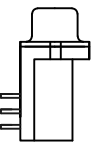
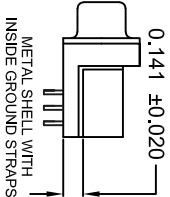
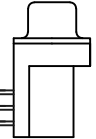
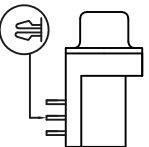
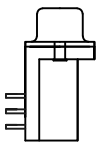
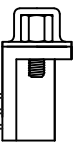
	0.141 ±0.020 METAL SHELL WITH INSIDE GROUND STRAPS		METAL SHELL		METAL SHELL FORK BOARD LOCKS
	.120" DIA. HOLE	16	43	55	
	4-40 FLUSH INSERT	17	45	53*	
	4-40 HEX STANDOFF** FEMALE SCREWLOCK	18	48	56	

*4.80mm Reference Hex Height

**Hardware option "59" => Hardware option "53" assembled with NorComp p/n's SFS04404NR & LW1T

DO NOT SCALE FROM DRAWING

	THESE DRAWINGS AND SPECIFICATIONS ARE THE PROPERTY OF NorComp AND SHALL NOT BE REPRODUCED, COPIED OR USED AS THE BASIS FOR THE MANUFACTURE OR SALE OF APPARATUS WITHOUT WRITTEN PERMISSION.		
	DRAWN:	DATE:	
NorComp	PAM JENKINS		03-15-05
	SCALE:	SHEET	OF
DWG NO.	NTS	3	3
181-YYY-213RRY1			REV 17

COMPLIANT

Looking for pricing, stock, or lifecycle information?

Click below to explore more details on WIN SOURCE:

 [View 181-015-213R561 on WIN SOURCE](#)

 [NorComp Inc. Information](#)

Optimize Your Supply Chain with WIN SOURCE Solutions

-  Global Sourcing Solution
-  Obsolete Management
-  Cost Control Management
-  Shortage Management
-  Alternative Solution
-  Excess Inventory Management