



# THE DATASHEET OF IR2130PBF



## IR2130/IR2132(J)(S) & (PbF)

### 3-PHASE BRIDGE DRIVER

#### Features

- Floating channel designed for bootstrap operation  
 Fully operational to +600V  
 Tolerant to negative transient voltage  
 dV/dt immune
- Gate drive supply range from 10 to 20V
- Undervoltage lockout for all channels
- Over-current shutdown turns off all six drivers
- Independent half-bridge drivers
- Matched propagation delay for all channels
- 2.5V logic compatible
- Outputs out of phase with inputs
- Cross-conduction prevention logic
- Also available LEAD-FREE

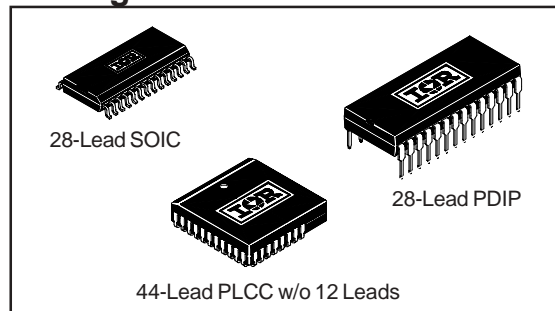
#### Description

The IR2130/IR2132(J)(S) is a high voltage, high speed power MOSFET and IGBT driver with three independent high and low side referenced output channels. Proprietary HVIC technology enables ruggedized monolithic construction. Logic inputs are compatible with CMOS or LSTTL outputs, down to 2.5V logic. A ground-referenced operational amplifier provides analog feedback of bridge current via an external current sense resistor. A current trip function which terminates all six outputs is also derived from this resistor. An open drain  $\overline{\text{FAULT}}$  signal indicates if an over-current or undervoltage shutdown has occurred. The output drivers feature a high pulse current buffer stage designed for minimum driver cross-conduction. Propagation delays are matched to simplify use at high frequencies. The floating channels can be used to drive N-channel power MOSFETs or IGBTs in the high side configuration which operate up to 600 volts.

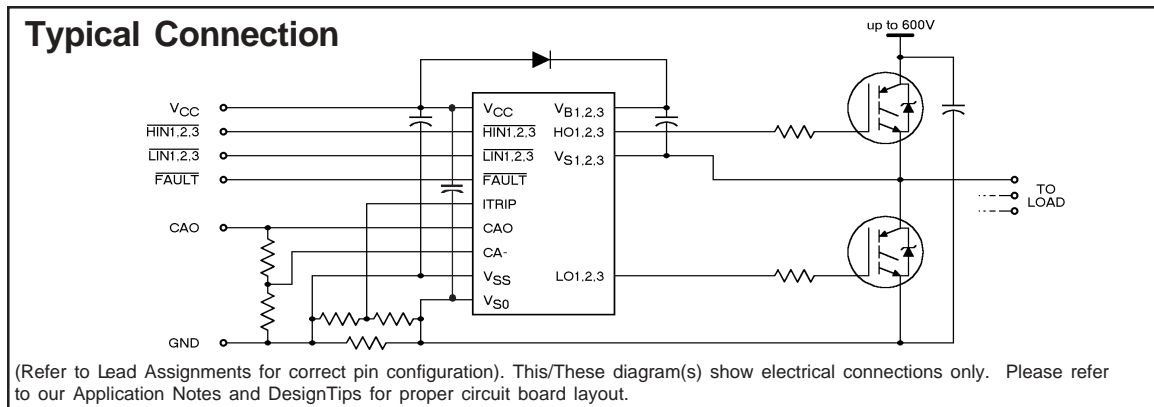
#### Product Summary

$V_{\text{OFFSET}}$	600V max.
$I_{\text{O}+/-}$	200 mA / 420 mA
$V_{\text{OUT}}$	10 - 20V
$t_{\text{on/off}}$ (typ.)	675 & 425 ns
Deadtime (typ.)	2.5 $\mu\text{s}$ (IR2130) 0.8 $\mu\text{s}$ (IR2132)

#### Packages



#### Typical Connection



# IR2130/IR2132(J)(S) & (PbF)

International  
IR Rectifier

## Absolute Maximum Ratings

Absolute Maximum Ratings indicate sustained limits beyond which damage to the device may occur. All voltage parameters are absolute voltages referenced to  $V_{S0}$ . The Thermal Resistance and Power Dissipation ratings are measured under board mounted and still air conditions. Additional information is shown in Figures 50 through 53.

Symbol	Definition	Min.	Max.	Units		
$V_{B1,2,3}$	High Side Floating Supply Voltage	-0.3	625	V		
$V_{S1,2,3}$	High Side Floating Offset Voltage	$V_{B1,2,3} - 25$	$V_{B1,2,3} + 0.3$			
$V_{HO1,2,3}$	High Side Floating Output Voltage	$V_{S1,2,3} - 0.3$	$V_{B1,2,3} + 0.3$			
$V_{CC}$	Low Side and Logic Fixed Supply Voltage	-0.3	25			
$V_{SS}$	Logic Ground	$V_{CC} - 25$	$V_{CC} + 0.3$			
$V_{LO1,2,3}$	Low Side Output Voltage	-0.3	$V_{CC} + 0.3$			
$V_{IN}$	Logic Input Voltage (HIN1,2,3, LIN1,2,3 & ITRIP)	$V_{SS} - 0.3$	( $V_{SS} + 15$ ) or ( $V_{CC} + 0.3$ ) whichever is lower			
$V_{FLT}$	FAULT Output Voltage	$V_{SS} - 0.3$	$V_{CC} + 0.3$			
$V_{CAO}$	Operational Amplifier Output Voltage	$V_{SS} - 0.3$	$V_{CC} + 0.3$			
$V_{CA-}$	Operational Amplifier Inverting Input Voltage	$V_{SS} - 0.3$	$V_{CC} + 0.3$			
dVs/dt	Allowable Offset Supply Voltage Transient	—	50		V/ns	
$P_D$	Package Power Dissipation @ $T_A \leq +25^\circ\text{C}$	(28 Lead DIP)	—		1.5	W
		(28 Lead SOIC)	—		1.6	
		(44 Lead PLCC)	—	2.0		
$R_{thJA}$	Thermal Resistance, Junction to Ambient	(28 Lead DIP)	—	83	$^\circ\text{C/W}$	
		(28 Lead SOIC)	—	78		
		(44 Lead PLCC)	—	63		
$T_J$	Junction Temperature	—	150	$^\circ\text{C}$		
$T_S$	Storage Temperature	-55	150			
$T_L$	Lead Temperature (Soldering, 10 seconds)	—	300			

## Recommended Operating Conditions

The Input/Output logic timing diagram is shown in Figure 1. For proper operation the device should be used within the recommended conditions. All voltage parameters are absolute voltages referenced to  $V_{S0}$ . The  $V_S$  offset rating is tested with all supplies biased at 15V differential. Typical ratings at other bias conditions are shown in Figure 54.

Symbol	Definition	Min.	Max.	Units
$V_{B1,2,3}$	High Side Floating Supply Voltage	$V_{S1,2,3} + 10$	$V_{S1,2,3} + 20$	V
$V_{S1,2,3}$	High Side Floating Offset Voltage	Note 1	600	
$V_{HO1,2,3}$	High Side Floating Output Voltage	$V_{S1,2,3}$	$V_{B1,2,3}$	
$V_{CC}$	Low Side and Logic Fixed Supply Voltage	10	20	
$V_{SS}$	Logic Ground	-5	5	
$V_{LO1,2,3}$	Low Side Output Voltage	0	$V_{CC}$	
$V_{IN}$	Logic Input Voltage (HIN1,2,3, LIN1,2,3 & ITRIP)	$V_{SS}$	$V_{SS} + 5$	
$V_{FLT}$	FAULT Output Voltage	$V_{SS}$	$V_{CC}$	
$V_{CAO}$	Operational Amplifier Output Voltage	$V_{SS}$	$V_{SS} + 5$	
$V_{CA-}$	Operational Amplifier Inverting Input Voltage	$V_{SS}$	$V_{SS} + 5$	
$T_A$	Ambient Temperature	-40	125	$^\circ\text{C}$

Note 1: Logic operational for  $V_S$  of ( $V_{S0} - 5V$ ) to ( $V_{S0} + 600V$ ). Logic state held for  $V_S$  of ( $V_{S0} - 5V$ ) to ( $V_{S0} - V_{BS}$ ). (Please refer to the Design Tip DT97-3 for more details).

Note 2: All input pins, CA- and CAO pins are internally clamped with a 5.2V zener diode.

## Dynamic Electrical Characteristics

$V_{BIAS}$  ( $V_{CC}$ ,  $V_{BS1,2,3}$ ) = 15V,  $V_{S0,1,2,3}$  =  $V_{SS}$ ,  $C_L$  = 1000 pF and  $T_A$  = 25°C unless otherwise specified. The dynamic electrical characteristics are defined in Figures 3 through 5.

Symbol	Definition	Figure	Min.	Typ.	Max.	Units	Test Conditions
$t_{on}$	Turn-On Propagation Delay	11	500	675	850	ns	
$t_{off}$	Turn-Off Propagation Delay	12	300	425	550		$V_{IN} = 0$ & 5V
$t_r$	Turn-On Rise Time	13	—	80	125		$V_{S1,2,3} = 0$ to 600V
$t_f$	Turn-Off Fall Time	14	—	35	55		
$t_{itrip}$	ITRIP to Output Shutdown Prop. Delay	15	400	660	920		$V_{IN}$ , $V_{ITRIP} = 0$ & 5V
$t_{bl}$	ITRIP Blanking Time	—	—	400	—		$V_{ITRIP} = 1V$
$t_{flt}$	ITRIP to $\overline{FAULT}$ Indication Delay	16	335	590	845		$V_{IN}$ , $V_{ITRIP} = 0$ & 5V
$t_{flt.in}$	Input Filter Time (All Six Inputs)	—	—	310	—		$V_{IN} = 0$ & 5V
$t_{fltclr}$	LIN1,2,3 to $\overline{FAULT}$ Clear Time	17	6.0	9.0	12.0		$V_{IN}$ , $V_{ITRIP} = 0$ & 5V
DT	Deadtime (IR2130)	18	1.3	2.5	3.7		$\mu s$
	(IR2132)	18	0.4	0.8	1.2		
SR+	Operational Amplifier Slew Rate (+)	19	4.4	6.2	—	V/ $\mu s$	
SR-	Operational Amplifier Slew Rate (-)	20	2.4	3.2	—		

NOTE: For high side PWM, HIN pulse width must be  $\geq 1.5\mu s$

## Static Electrical Characteristics

$V_{BIAS}$  ( $V_{CC}$ ,  $V_{BS1,2,3}$ ) = 15V,  $V_{S0,1,2,3}$  =  $V_{SS}$  and  $T_A$  = 25°C unless otherwise specified. The  $V_{IN}$ ,  $V_{TH}$  and  $I_{IN}$  parameters are referenced to  $V_{SS}$  and are applicable to all six logic input leads: HIN1,2,3 & LIN1,2,3. The  $V_O$  and  $I_O$  parameters are referenced to  $V_{S0,1,2,3}$  and are applicable to the respective output leads: HO1,2,3 or LO1,2,3.

Symbol	Definition	Figure	Min.	Typ.	Max.	Units	Test Conditions
$V_{IH}$	Logic "0" Input Voltage (OUT = LO)	21	2.2	—	—	V	
$V_{IL}$	Logic "1" Input Voltage (OUT = HI)	22	—	—	0.8		
$V_{IT,TH+}$	ITRIP Input Positive Going Threshold	23	400	490	580	mV	
$V_{OH}$	High Level Output Voltage, $V_{BIAS} - V_O$	24	—	—	100		$V_{IN} = 0V$ , $I_O = 0A$
$V_{OL}$	Low Level Output Voltage, $V_O$	25	—	—	100	$V_{IN} = 5V$ , $I_O = 0A$	
$I_{LK}$	Offset Supply Leakage Current	26	—	—	50	$\mu A$	$V_B = V_S = 600V$
$I_{QBS}$	Quiescent $V_{BS}$ Supply Current	27	—	15	30		$V_{IN} = 0V$ or 5V
$I_{QCC}$	Quiescent $V_{CC}$ Supply Current	28	—	3.0	4.0	mA	$V_{IN} = 0V$ or 5V
$I_{IN+}$	Logic "1" Input Bias Current (OUT = HI)	29	—	450	650		$V_{IN} = 0V$
$I_{IN-}$	Logic "0" Input Bias Current (OUT = LO)	30	—	225	400	$\mu A$	$V_{IN} = 5V$
$I_{ITRIP+}$	"High" ITRIP Bias Current	31	—	75	150		ITRIP = 5V
$I_{ITRIP-}$	"Low" ITRIP Bias Current	32	—	—	100	nA	ITRIP = 0V
$V_{BSUV+}$	$V_{BS}$ Supply Undervoltage Positive Going Threshold	33	7.5	8.35	9.2	V	
$V_{BSUV-}$	$V_{BS}$ Supply Undervoltage Negative Going Threshold	34	7.1	7.95	8.8		
$V_{CCUV+}$	$V_{CC}$ Supply Undervoltage Positive Going Threshold	35	8.3	9.0	9.7		
$V_{CCUV-}$	$V_{CC}$ Supply Undervoltage Negative Going Threshold	36	8.0	8.7	9.4		
$R_{on,FLT}$	$\overline{FAULT}$ Low On-Resistance	37	—	55	75		$\Omega$

# IR2130/IR2132(J)(S) & (PbF)

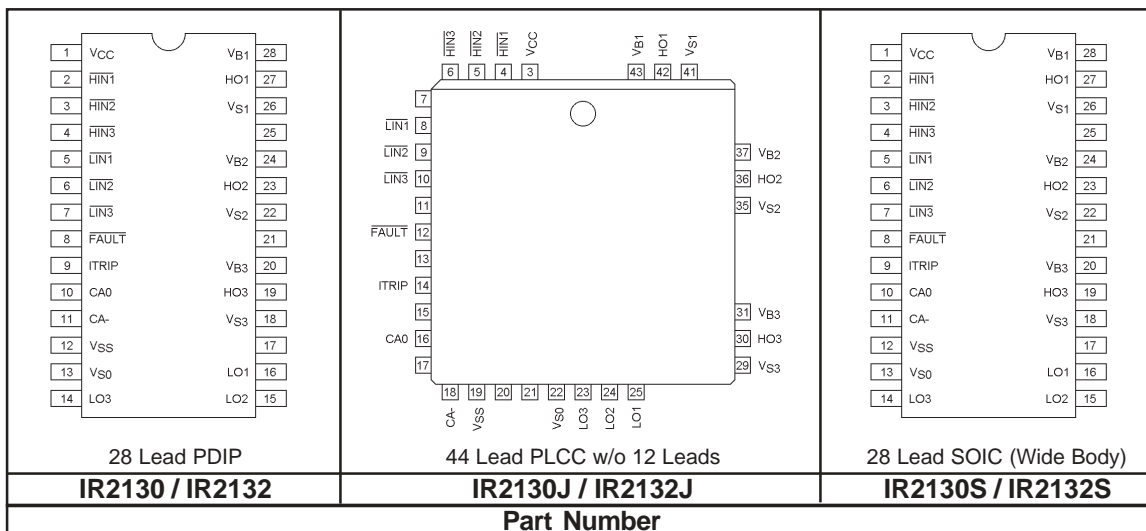
International  
**IR** Rectifier

## Static Electrical Characteristics -- Continued

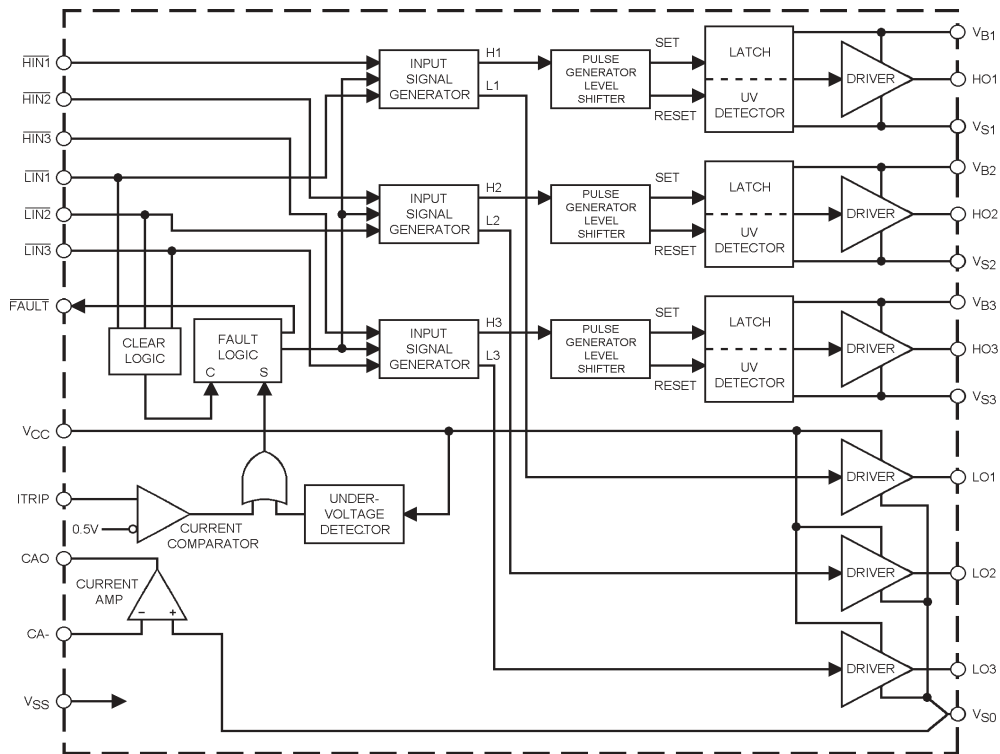
$V_{BIAS}$  ( $V_{CC}$ ,  $V_{BS1,2,3}$ ) = 15V,  $V_{S0,1,2,3}$  =  $V_{SS}$  and  $T_A$  = 25°C unless otherwise specified. The  $V_{IN}$ ,  $V_{TH}$  and  $I_{IN}$  parameters are referenced to  $V_{SS}$  and are applicable to all six logic input leads:  $HIN1,2,3$  &  $LIN1,2,3$ . The  $V_O$  and  $I_O$  parameters are referenced to  $V_{S0,1,2,3}$  and are applicable to the respective output leads:  $HO1,2,3$  or  $LO1,2,3$ .

Symbol	Definition	Figure	Min.	Typ.	Max.	Units	Test Conditions
$I_{O+}$	Output High Short Circuit Pulsed Current	38	200	250	—	mA	$V_O = 0V$ , $V_{IN} = 0V$ $PW \leq 10 \mu s$
$I_{O-}$	Output Low Short Circuit Pulsed Current	39	420	500	—		$V_O = 15V$ , $V_{IN} = 5V$ $PW \leq 10 \mu s$
$V_{OS}$	Operational Amplifier Input Offset Voltage	40	—	—	30	mV	$V_{S0} = V_{CA-} = 0.2V$
$I_{CA-}$	CA- Input Bias Current	41	—	—	4.0	nA	$V_{CA-} = 2.5V$
CMRR	Op. Amp. Common Mode Rejection Ratio	42	60	80	—	dB	$V_{S0} = V_{CA-} = 0.1V$ & $5V$
PSRR	Op. Amp. Power Supply Rejection Ratio	43	55	75	—		$V_{S0} = V_{CA-} = 0.2V$ $V_{CC} = 10V$ & $20V$
$V_{OH,AMP}$	Op. Amp. High Level Output Voltage	44	5.0	5.2	5.4	V	$V_{CA-} = 0V$ , $V_{S0} = 1V$
$V_{OL,AMP}$	Op. Amp. Low Level Output Voltage	45	—	—	20	mV	$V_{CA-} = 1V$ , $V_{S0} = 0V$
$I_{SRC,AMP}$	Op. Amp. Output Source Current	46	2.3	4.0	—	mA	$V_{CA-} = 0V$ , $V_{S0} = 1V$ $V_{CA0} = 4V$
$I_{SRC,AMP}$	Op. Amp. Output Sink Current	47	1.0	2.1	—		$V_{CA-} = 1V$ , $V_{S0} = 0V$ $V_{CA0} = 2V$
$I_{O+,AMP}$	Operational Amplifier Output High Short Circuit Current	48	—	4.5	6.5		$V_{CA-} = 0V$ , $V_{S0} = 5V$ $V_{CA0} = 0V$
$I_{O-,AMP}$	Operational Amplifier Output Low Short Circuit Current	49	—	3.2	5.2		$V_{CA-} = 5V$ , $V_{S0} = 0V$ $V_{CA0} = 5V$

## Lead Assignments



## Functional Block Diagram



## Lead Definitions

Symbol	Description
HIN1,2,3	Logic inputs for high side gate driver outputs (HO1,2,3), out of phase
LIN1,2,3	Logic inputs for low side gate driver output (LO1,2,3), out of phase
FAULT	Indicates over-current or undervoltage lockout (low side) has occurred, negative logic
VCC	Low side and logic fixed supply
ITRIP	Input for over-current shutdown
CAO	Output of current amplifier
CA-	Negative input of current amplifier
VSS	Logic ground
Vb1,2,3	High side floating supplies
HO1,2,3	High side gate drive outputs
Vs1,2,3	High side floating supply returns
LO1,2,3	Low side gate drive outputs
Vs0	Low side return and positive input of current amplifier

# IR2130/IR2132(J)(S) & (PbF)

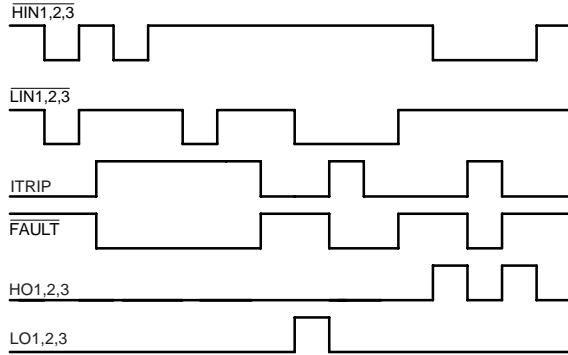


Figure 1. Input/Output Timing Diagram

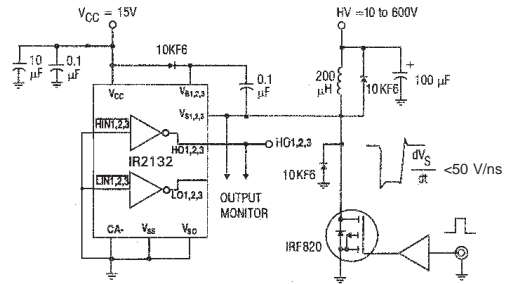


Figure 2. Floating Supply Voltage Transient Test Circuit

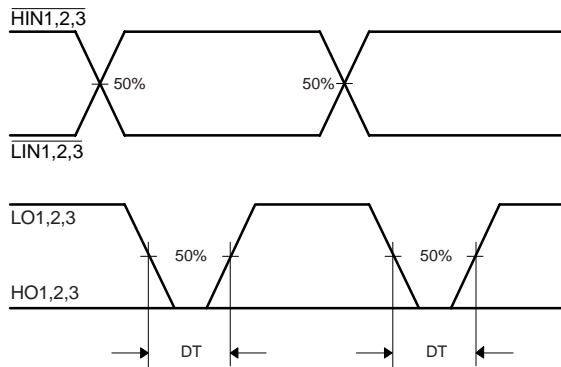


Figure 3. Deadtime Waveform Definitions

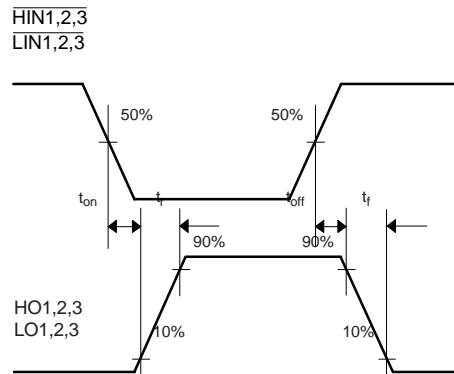
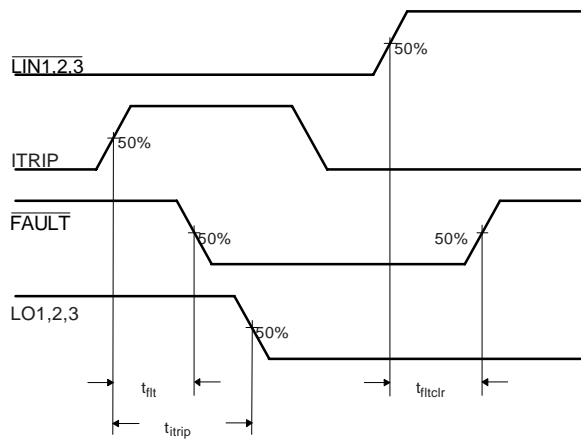
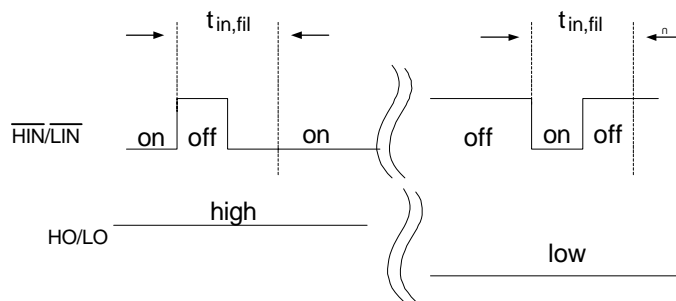


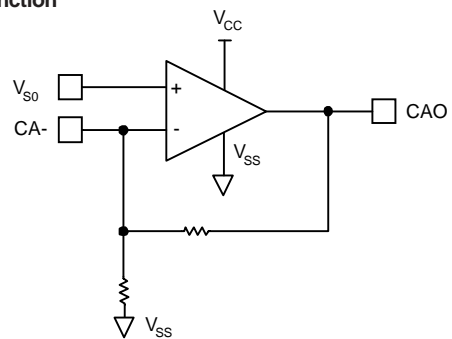
Figure 4. Input/Output Switching Time Waveform Definitions



**Figure 5. Overcurrent Shutdown Switching Time Waveform Definitions**

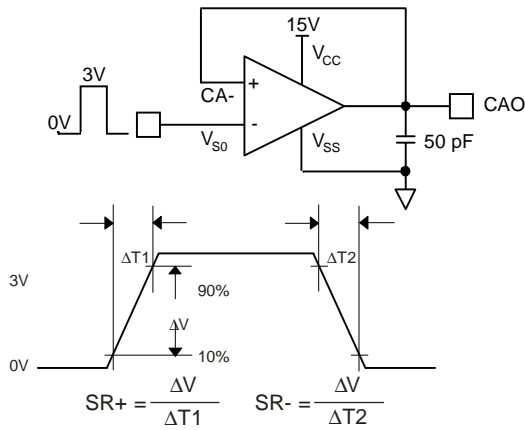


**Figure 5.5 Input Filter Function**

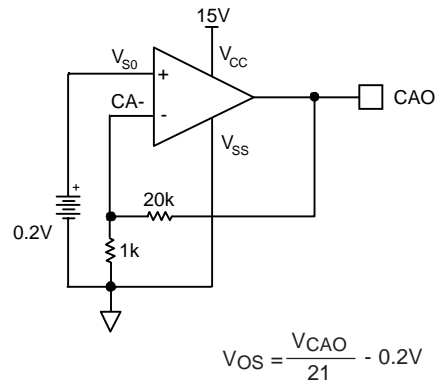


**Figure 6. Diagnostic Feedback Operational Amplifier Circuit**

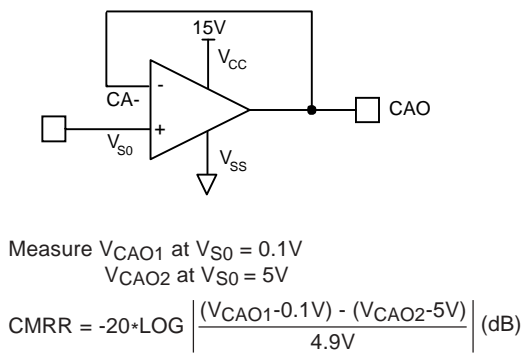
# IR2130/IR2132(J)(S) & (PbF)



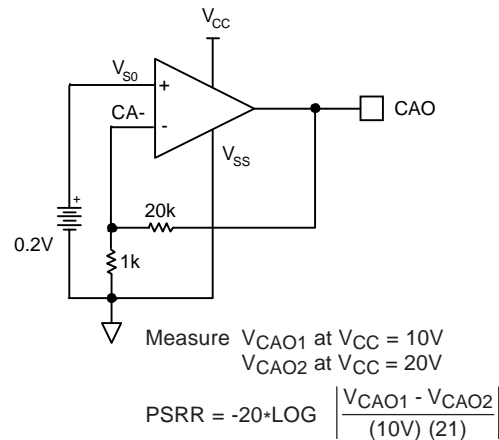
**Figure 7. Operational Amplifier Slew Rate Measurement**



**Figure 8. Operational Amplifier Input Offset Voltage Measurement**



**Figure 9. Operational Amplifier Common Mode Rejection Ratio Measurements**



**Figure 10. Operational Amplifier Power Supply Rejection Ratio Measurements**

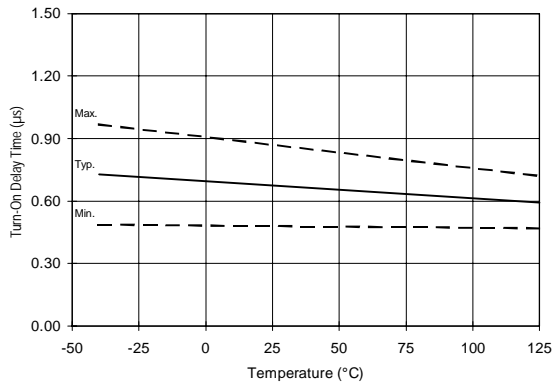


Figure 11A. Turn-On Time vs. Temperature

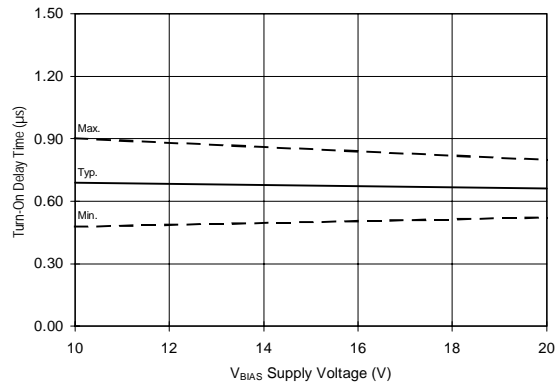


Figure 11B. Turn-On Time vs. Supply Voltage

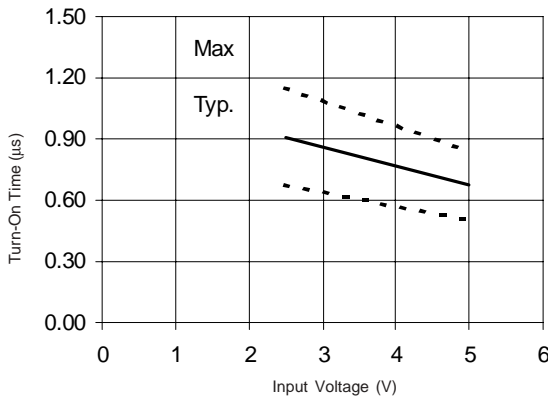


Figure 11C. Turn-On Time vs. Voltage

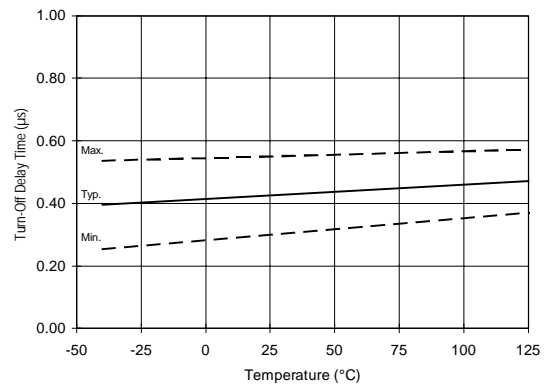


Figure 12A. Turn-Off Time vs. Temperature

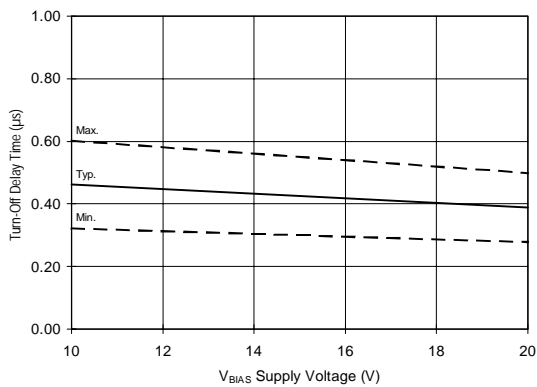


Figure 12B. Turn-Off Time vs. Supply Voltage

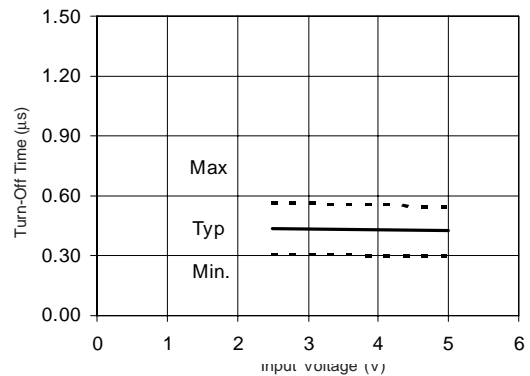


Figure 12C. Turn-Off Time vs. Input Voltage

# IR2130/IR2132(J)(S) & (PbF)

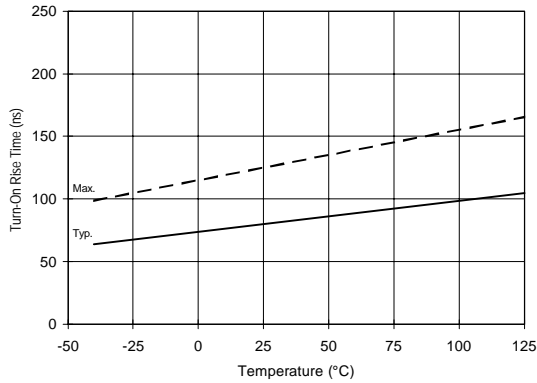


Figure 13A. Turn-On Rise Time vs. Temperature

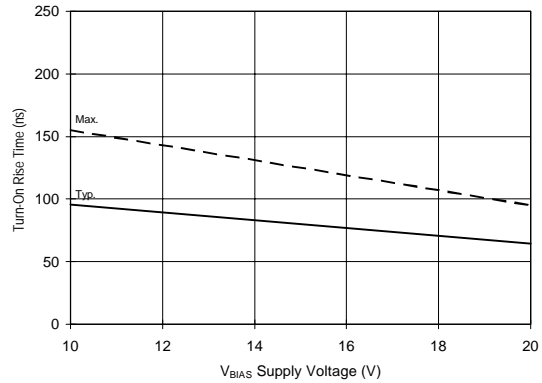


Figure 13B. Turn-On Rise Time vs. Voltage

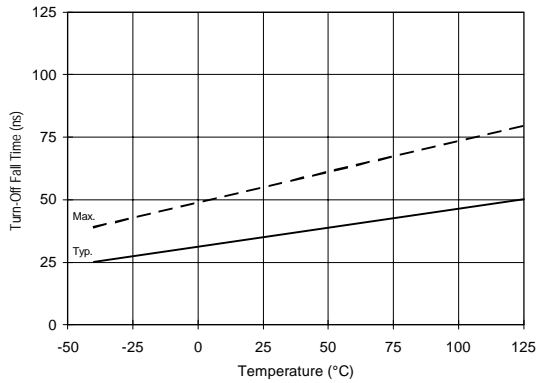


Figure 14A. Turn-Off Fall Time vs. Temperature

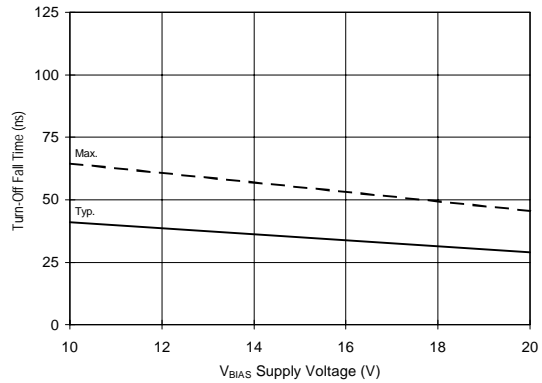


Figure 14B. Turn-Off Fall Time vs. Voltage

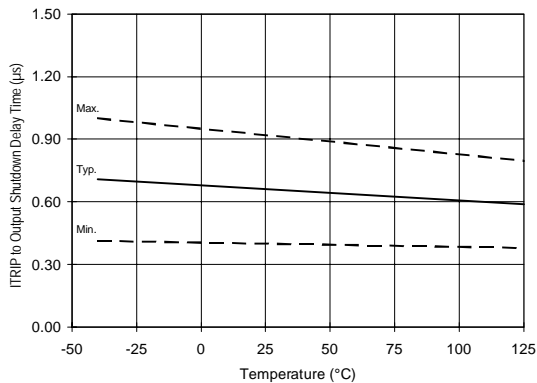


Figure 15A. ITRIP to Output Shutdown Delay Time vs. Temperature

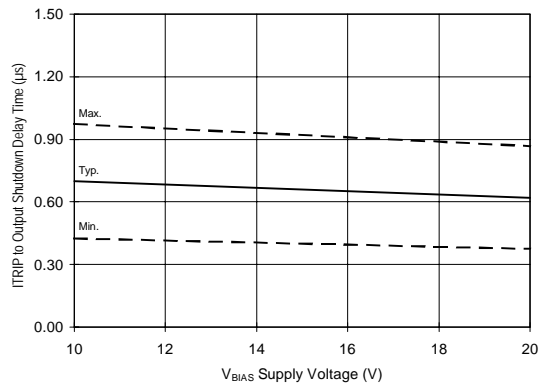


Figure 15B. ITRIP to Output Shutdown Delay Time vs. Voltage

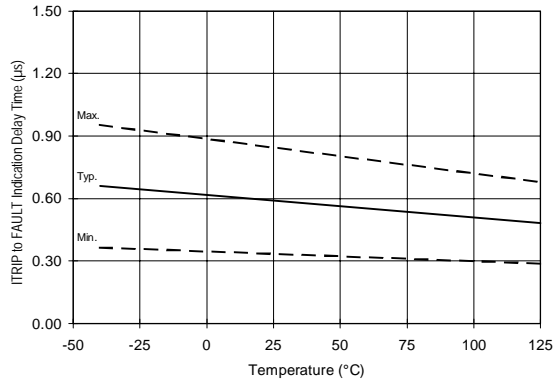


Figure 16A. ITRIP to  $\overline{\text{FAULT}}$  Indication Time vs. Temperature

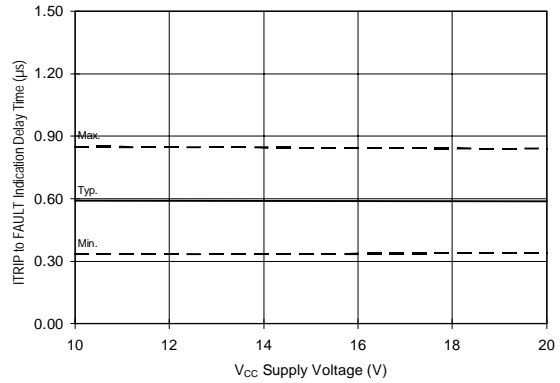


Figure 16B. ITRIP to  $\overline{\text{FAULT}}$  Indication Time vs. Voltage

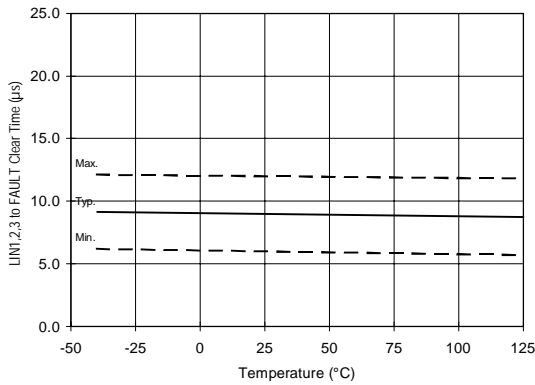


Figure 17A.  $\overline{\text{LIN1,2,3}}$  to  $\overline{\text{FAULT}}$  Clear Time vs. Temperature

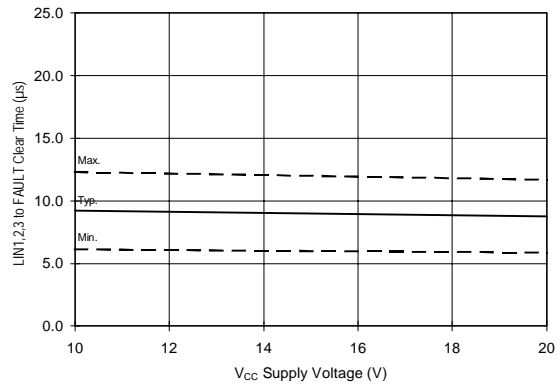


Figure 17B.  $\overline{\text{LIN1,2,3}}$  to  $\overline{\text{FAULT}}$  Clear Time vs. Voltage

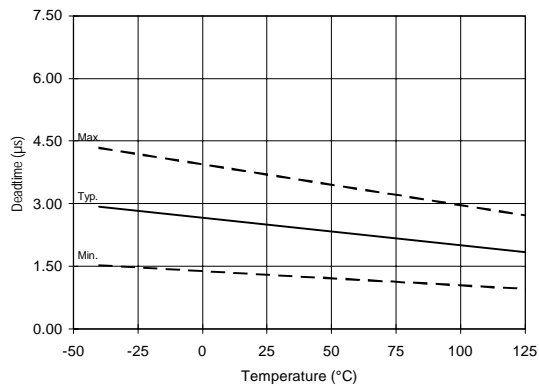


Figure 18A. Deadtime vs. Temperature (IR2130)

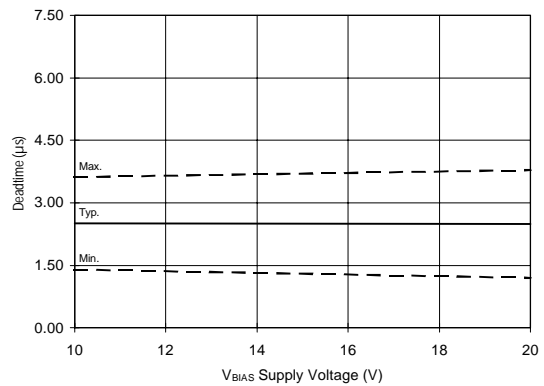


Figure 18B. Deadtime vs. Voltage (IR2130)

# IR2130/IR2132(J)(S) & (PbF)

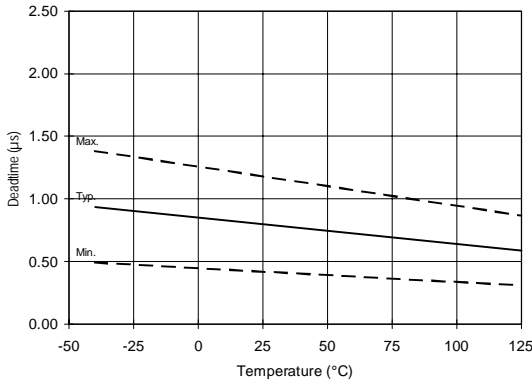


Figure 18C. Deadtime vs. Temperature (IR2132)

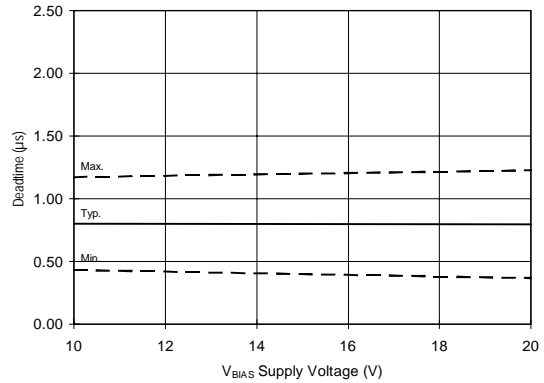


Figure 18D. Deadtime vs. Voltage (IR2132)

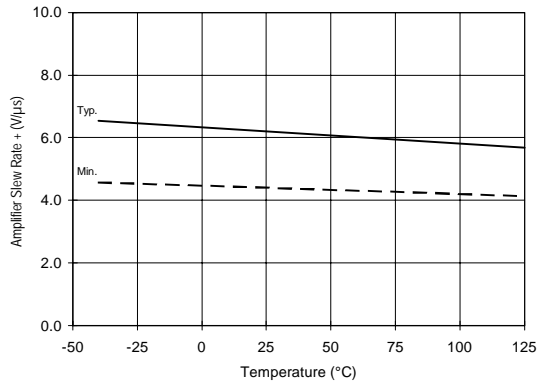


Figure 19A. Amplifier Slew Rate (+) vs. Temperature

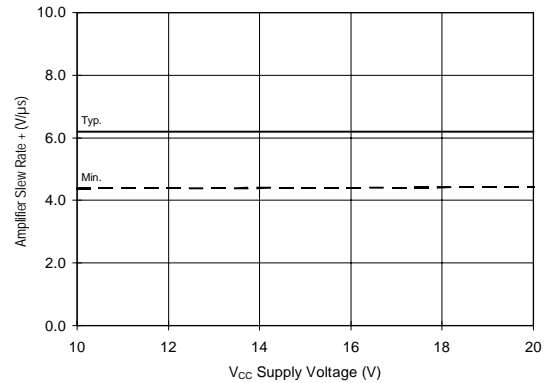


Figure 19B. Amplifier Slew Rate (+) vs. Voltage

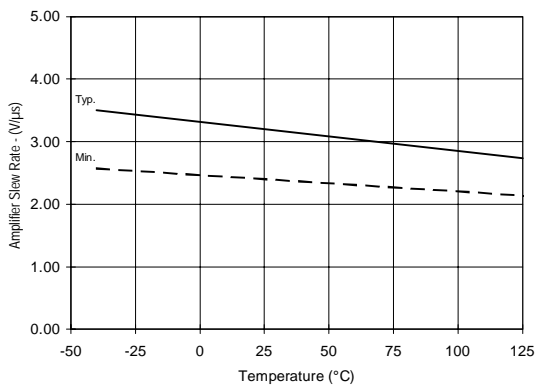


Figure 20A. Amplifier Slew Rate (-) vs. Temperature

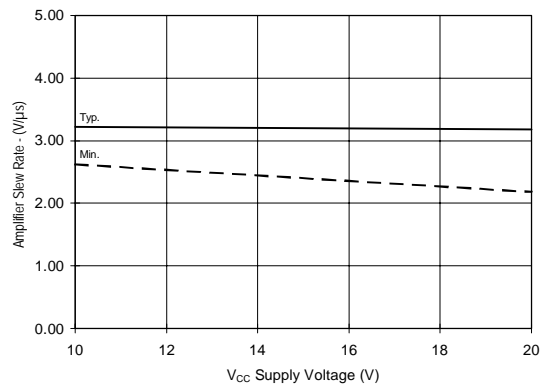
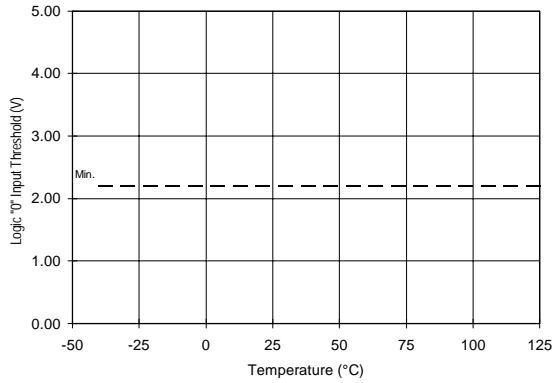
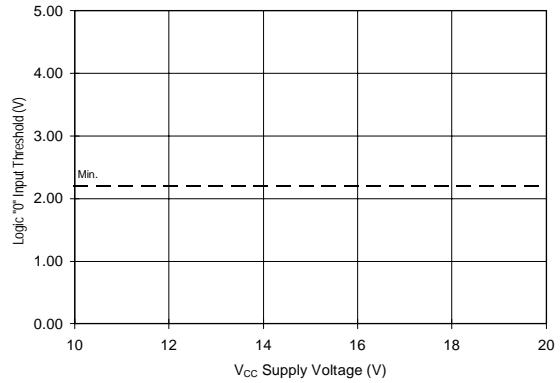


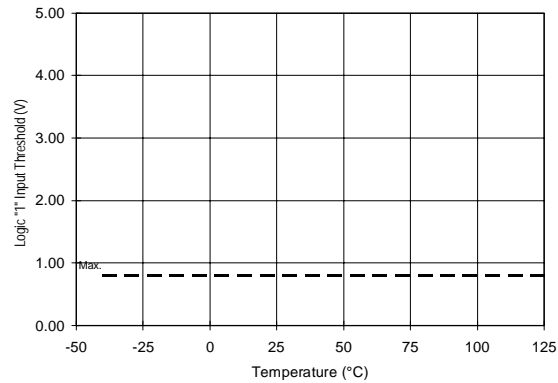
Figure 20B. Amplifier Slew Rate (-) vs. Voltage



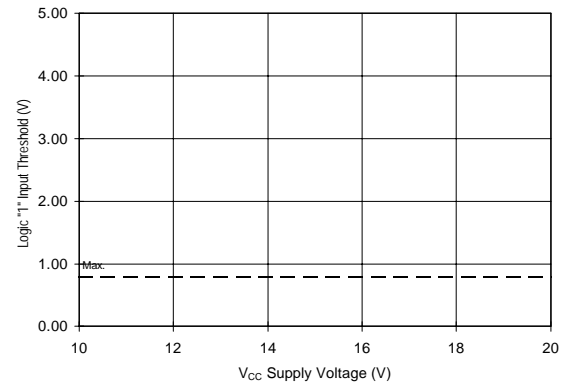
**Figure 21A. Logic "0" Input Threshold vs. Temperature**



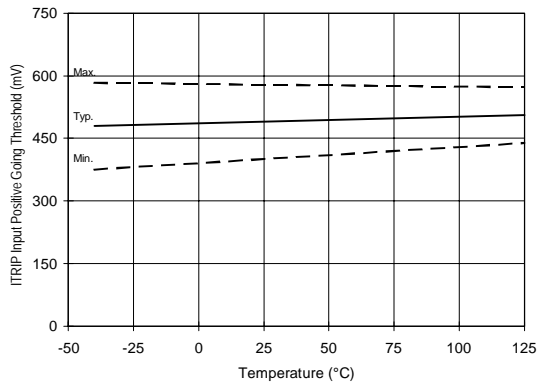
**Figure 20B. Logic "0" Input Threshold vs. Voltage**



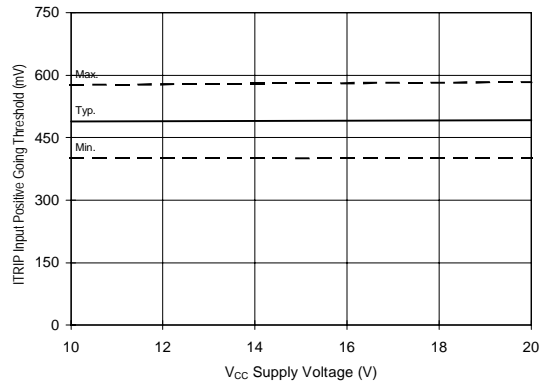
**Figure 22A. Logic "1" Input Threshold vs. Temperature**



**Figure 22B. Logic "1" Input Threshold vs. Voltage**



**Figure 23A. ITRIP Input Positive Going Threshold vs. Temperature**



**Figure 23B. ITRIP Input Positive Going Threshold vs. Voltage**

# IR2130/IR2132(J)(S) & (PbF)

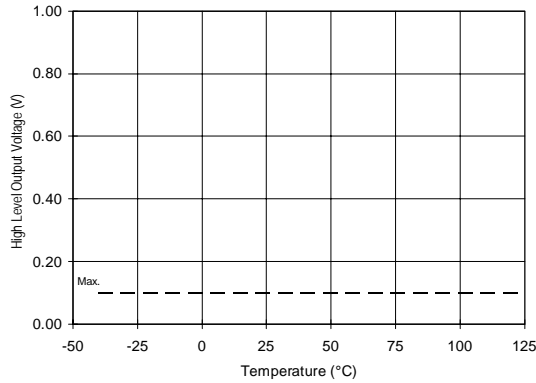


Figure 24A. High Level Output vs. Temperature

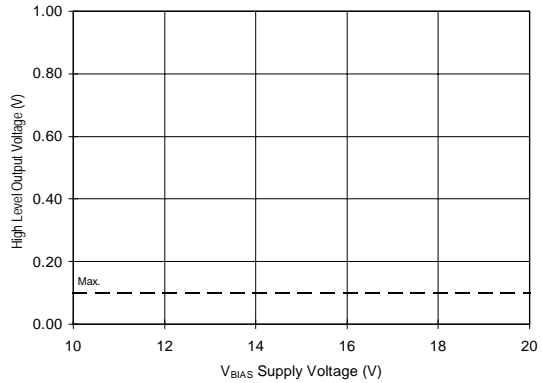


Figure 24B. High Level Output vs. Voltage

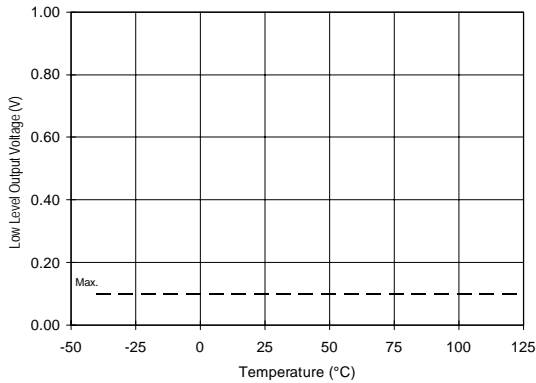


Figure 25A. Low Level Output vs. Temperature

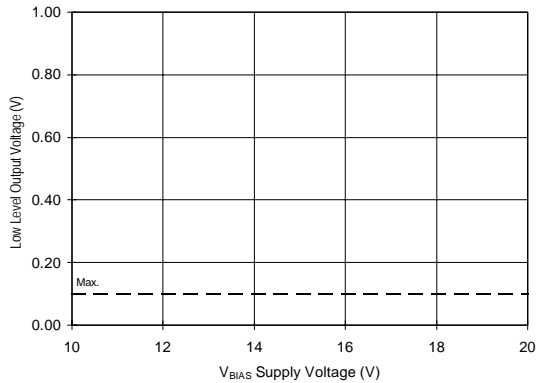


Figure 25B. Low Level Output vs. Voltage

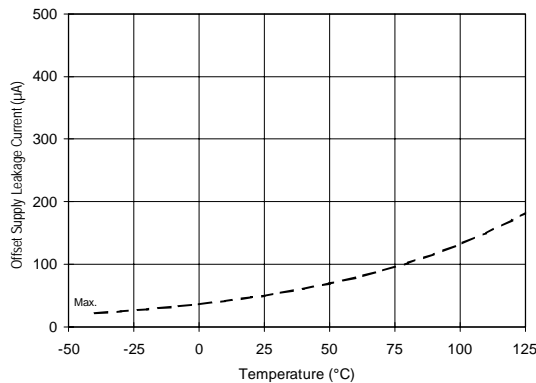


Figure 26A. Offset Supply Leakage Current vs. Temperature

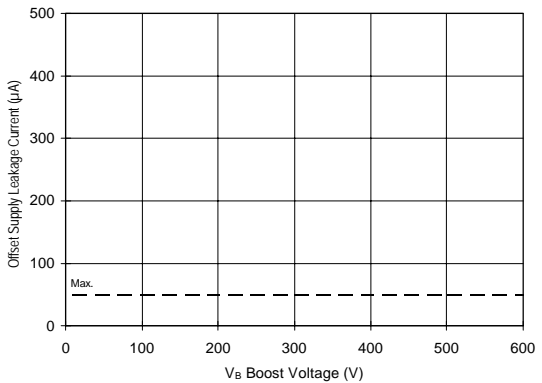


Figure 26B. Offset Supply Leakage Current vs. Voltage

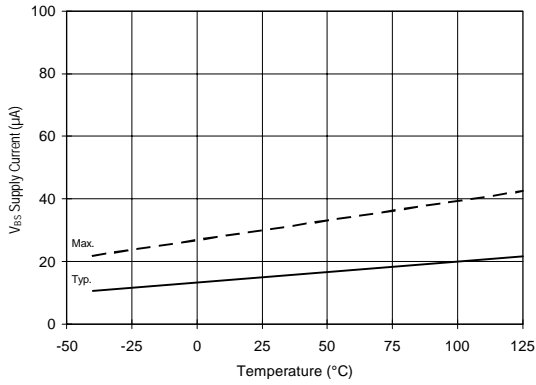


Figure 27A. V<sub>BS</sub> Supply Current vs. Temperature

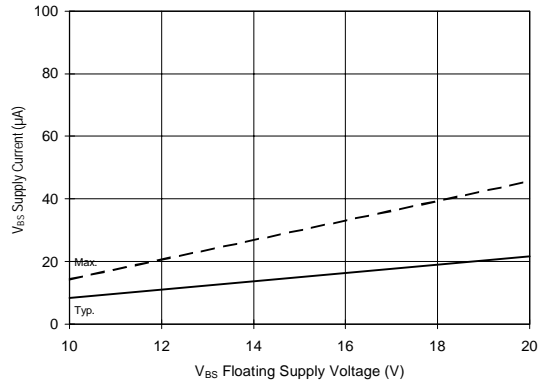


Figure 27B. V<sub>BS</sub> Supply Current vs. Voltage

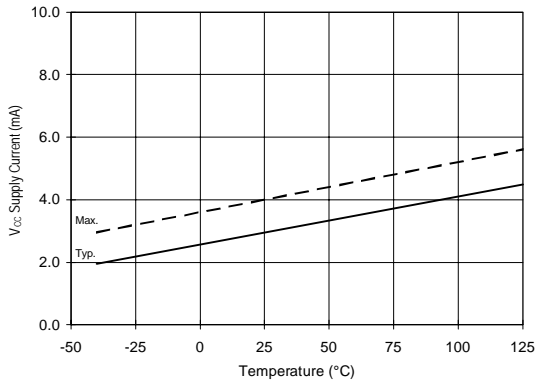


Figure 28A. V<sub>CC</sub> Supply Current vs. Temperature

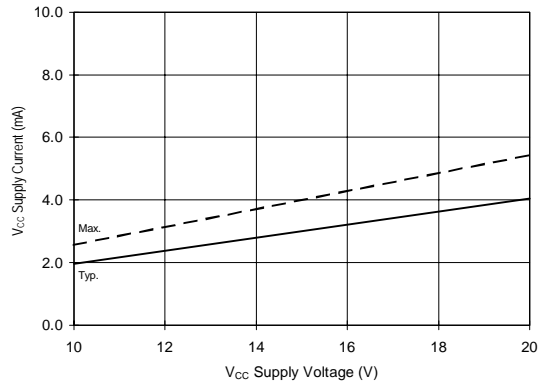


Figure 28B. V<sub>CC</sub> Supply Current vs. Voltage

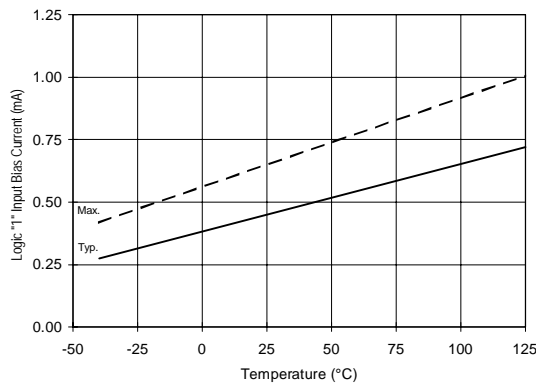


Figure 29A. Logic "1" Input Current vs. Temperature

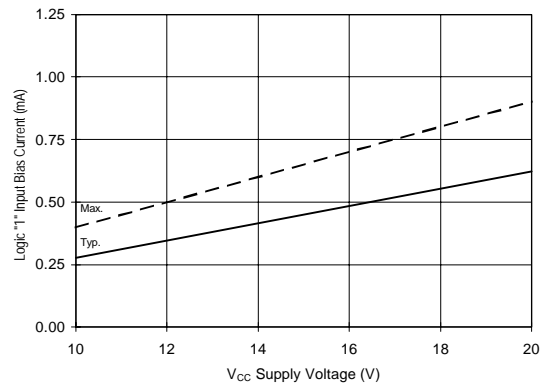


Figure 29B. Logic "1" Input Current vs. Voltage

# IR2130/IR2132(J)(S) & (PbF)

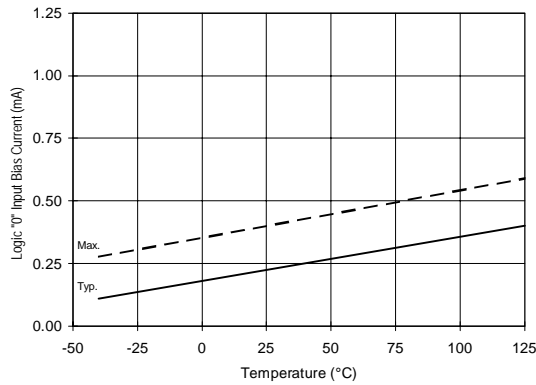


Figure 30A. Logic "0" Input Current vs. Temperature

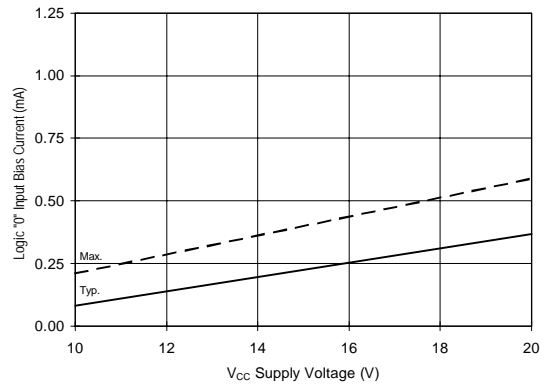


Figure 30B. Logic "0" Input Current vs. Voltage

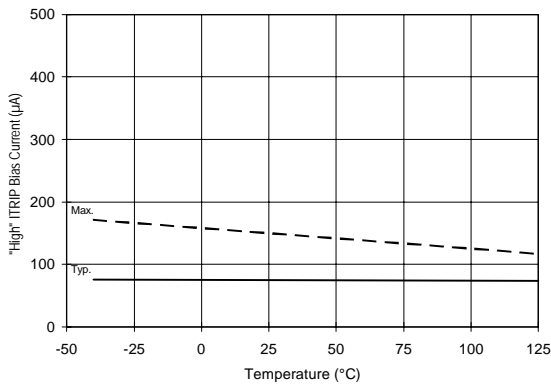


Figure 31A. "High" ITRIP Current vs. Temperature

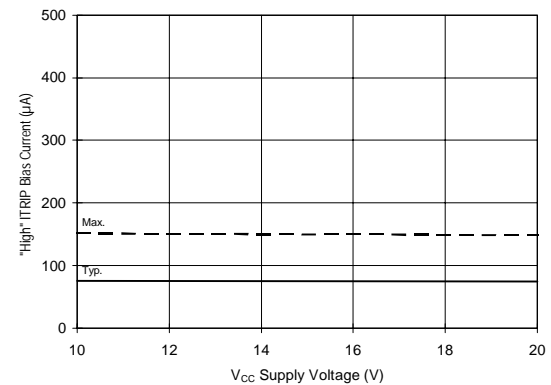


Figure 31B. "High" ITRIP Current vs. Voltage

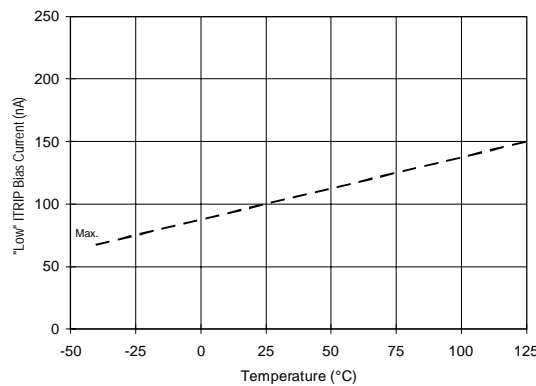


Figure 32A. "Low" ITRIP Current vs. Temperature

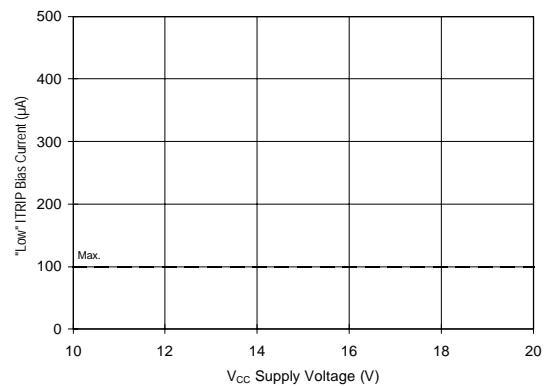
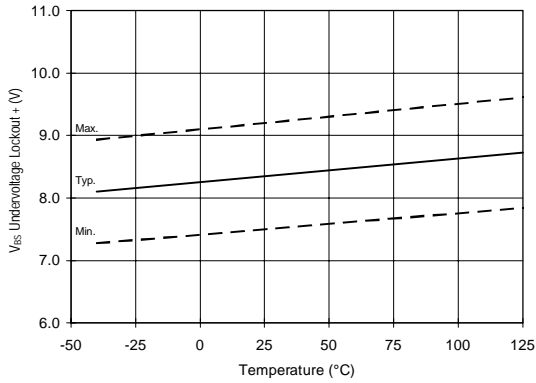
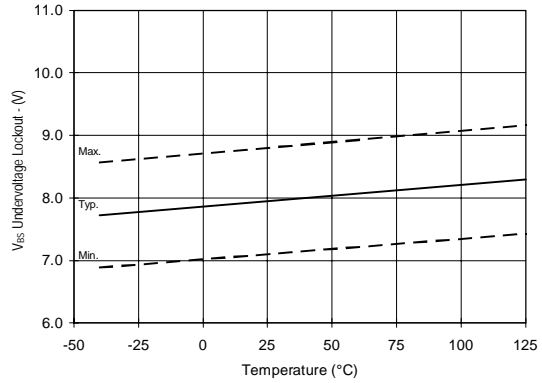


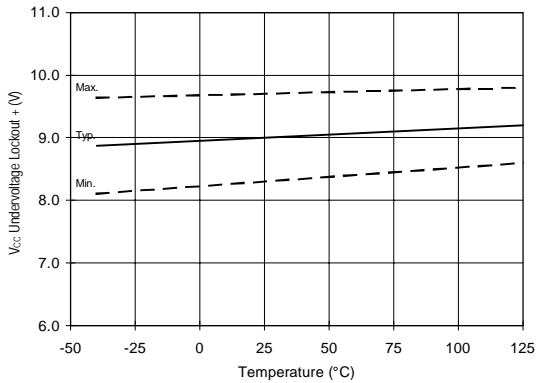
Figure 32B. "Low" ITRIP Current vs. Voltage



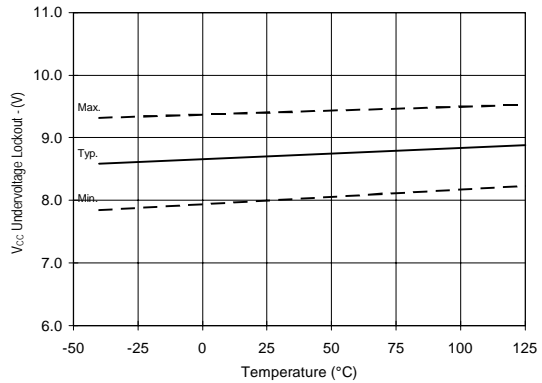
**Figure 33.  $V_{BS}$  Undervoltage (+) vs. Temperature**



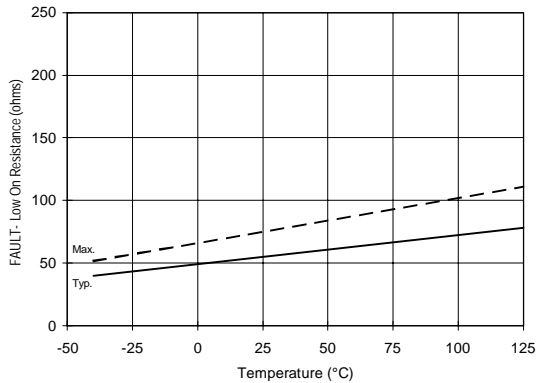
**Figure 34.  $V_{BS}$  Undervoltage (-) vs. Temperature**



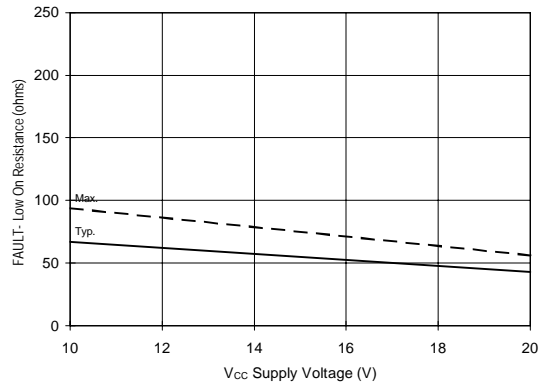
**Figure 35.  $V_{CC}$  Undervoltage (+) vs. Temperature**



**Figure 36.  $V_{CC}$  Undervoltage (-) vs. Temperature**



**Figure 37A.  $\overline{\text{FAULT}}$  Low On Resistance vs. Temperature**



**Figure 37B.  $\overline{\text{FAULT}}$  Low On Resistance vs. Voltage**

# IR2130/IR2132(J)(S) & (PbF)

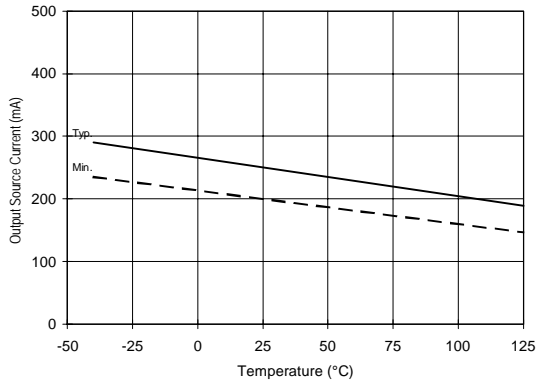


Figure 38A. Output Source Current vs. Temperature

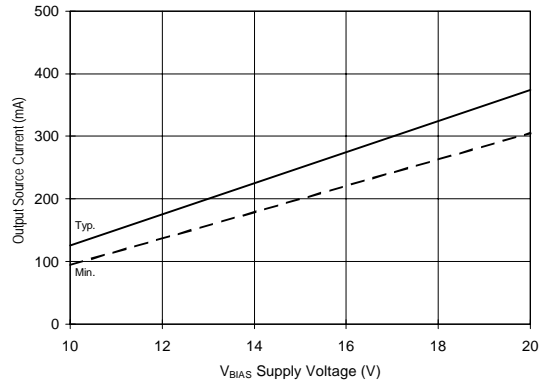


Figure 38B. Output Source Current vs. Voltage

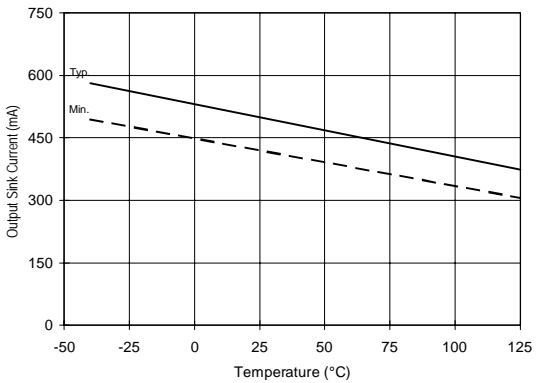


Figure 39A. Output Sink Current vs. Temperature

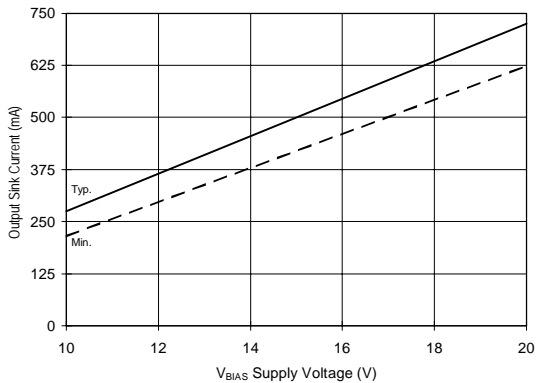


Figure 39B. Output Sink Current vs. Voltage

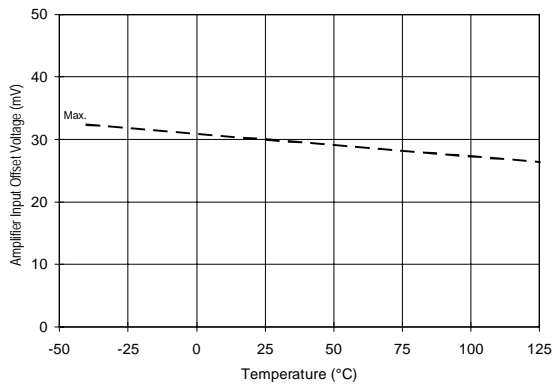


Figure 40A. Amplifier Input Offset vs. Temperature

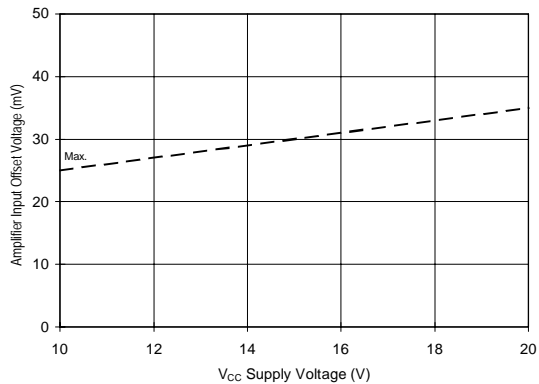


Figure 40B. Amplifier Input Offset vs. Voltage

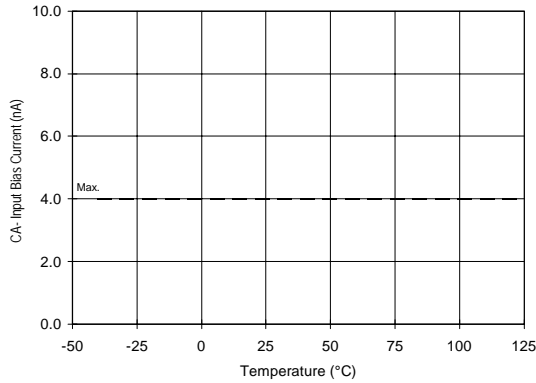


Figure 41A. CA- Input Current vs. Temperature

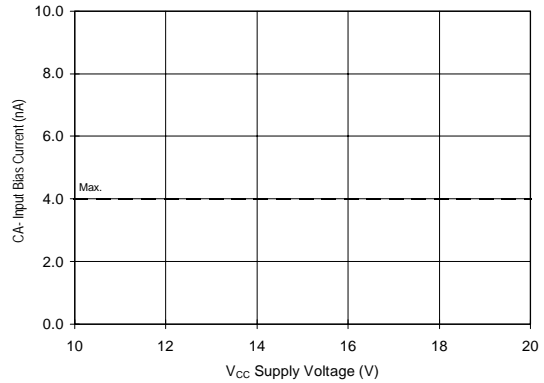


Figure 41B. CA- Input Current vs. Voltage

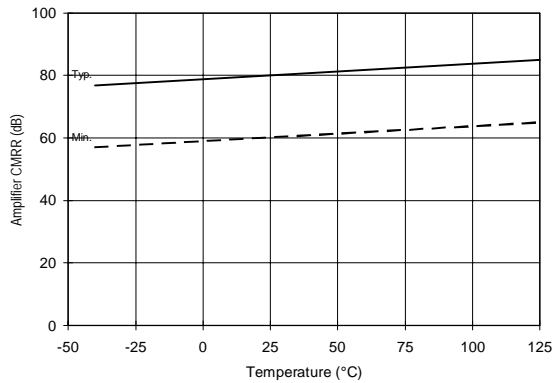


Figure 42A. Amplifier CMRR vs. Temperature

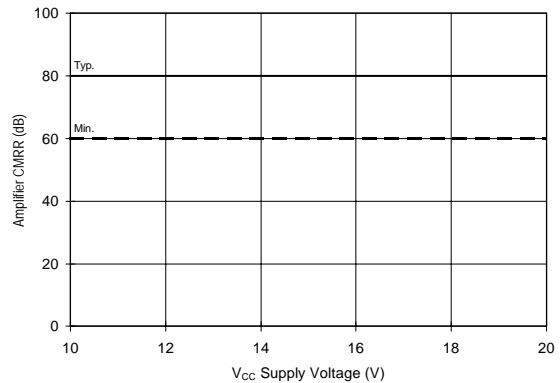


Figure 42B. Amplifier CMRR vs. Voltage

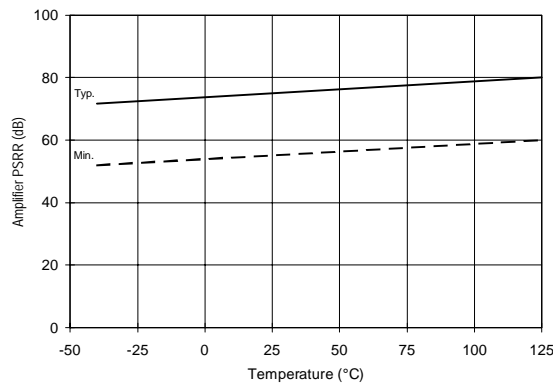


Figure 43A. Amplifier PSRR vs. Temperature

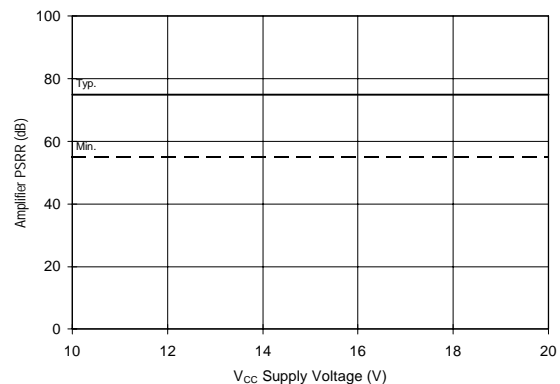
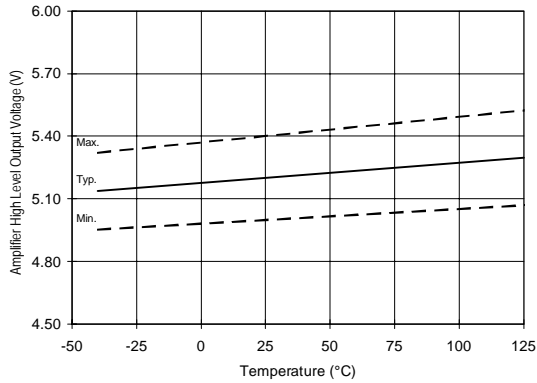
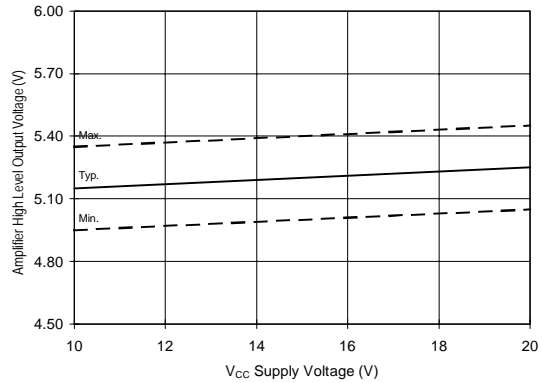


Figure 43B. Amplifier PSRR vs. Voltage

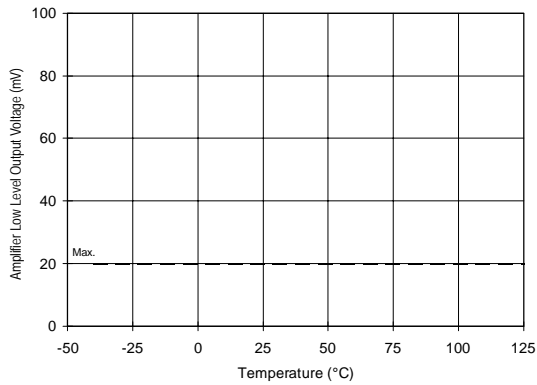
# IR2130/IR2132(J)(S) & (PbF)



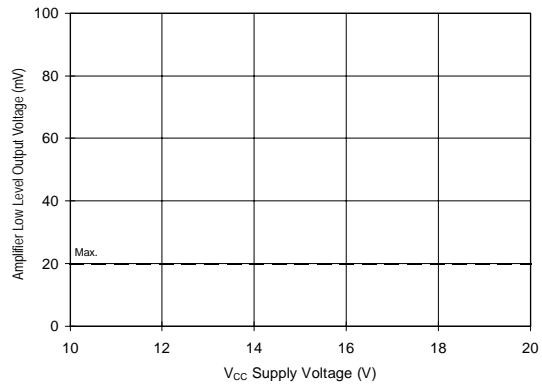
**Figure 44A. Amplifier High Level Output vs. Temperature**



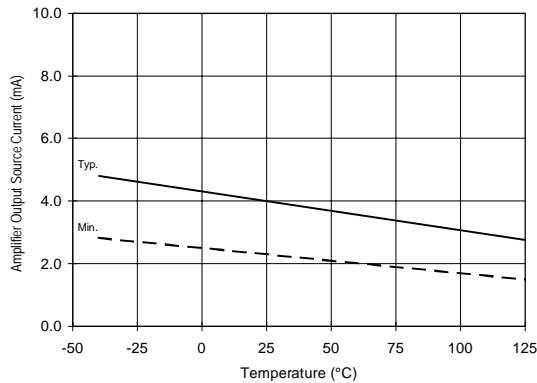
**Figure 44B. Amplifier High Level Output vs. Voltage**



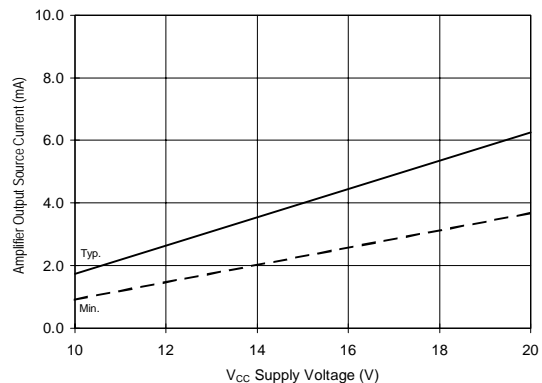
**Figure 45A. Amplifier Low Level Output vs. Temperature**



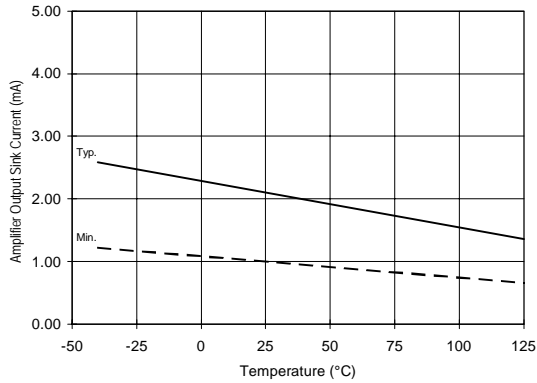
**Figure 45B. Amplifier Low Level Output vs. Voltage**



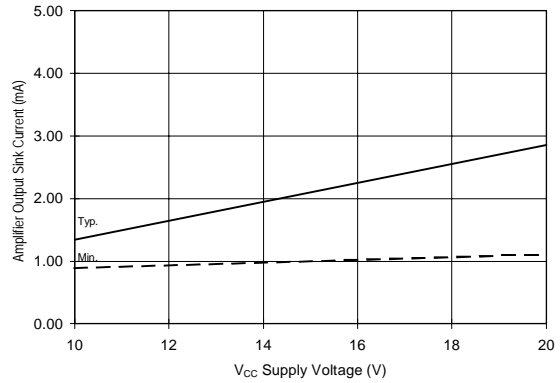
**Figure 46A. Amplifier Output Source Current vs. Temperature**



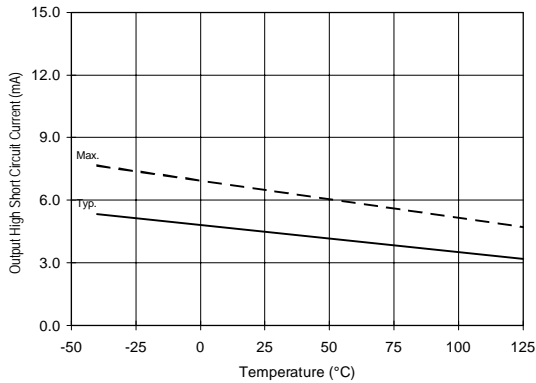
**Figure 46B. Amplifier Output Source Current vs. Voltage**



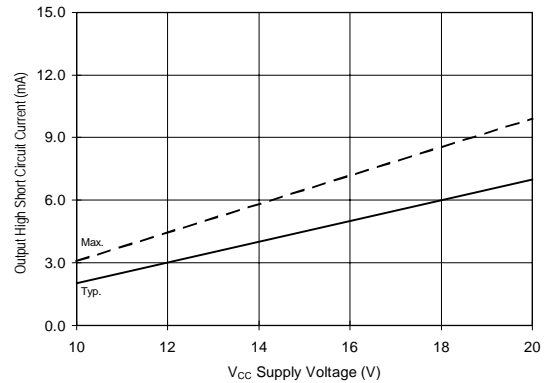
**Figure 47A. Amplifier Output Sink Current vs. Temperature**



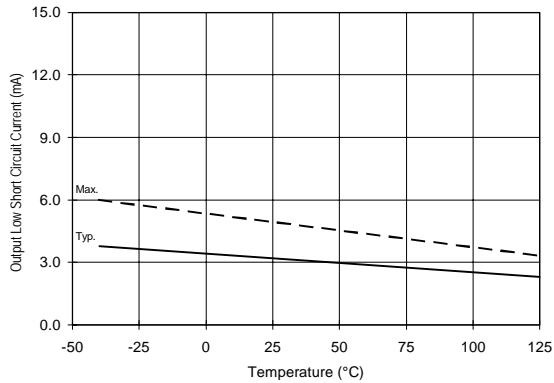
**Figure 47B. Amplifier Output Sink Current vs. Voltage**



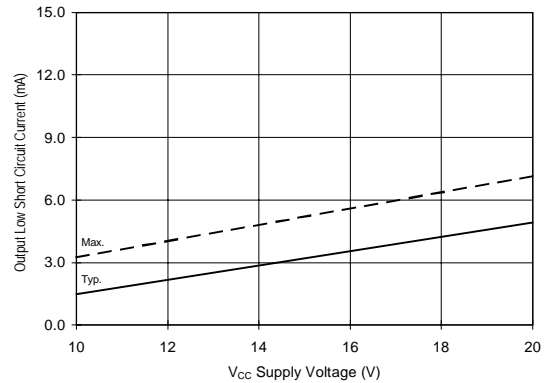
**Figure 48A. Amplifier Output High Short Circuit Current vs. Temperature**



**Figure 48B. Amplifier Output High Short Circuit Current vs. Voltage**



**Figure 49A. Amplifier Output Low Short Circuit Current vs. Temperature**



**Figure 49B. Amplifier Output Low Short Circuit Current vs. Voltage**

# IR2130/IR2132(J)(S) & (PbF)

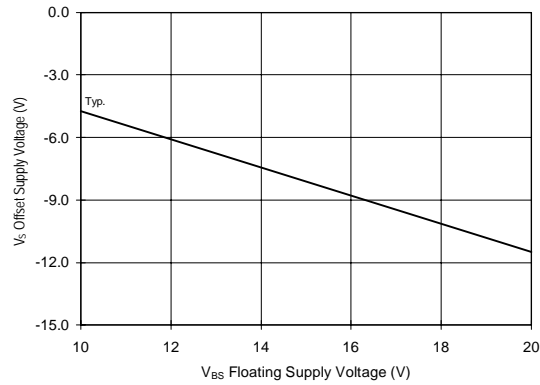


Figure 50. Maximum VS Negative Offset vs. V<sub>BS</sub> Supply Voltage

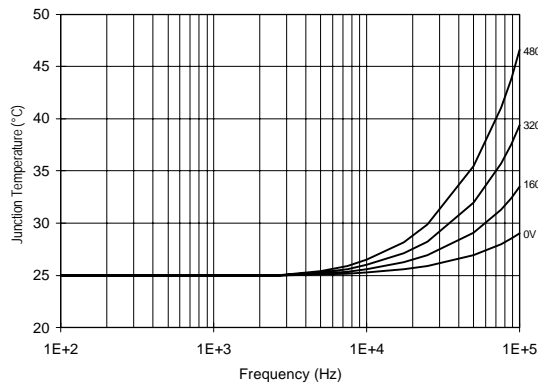


Figure 51. IR2130/IR2132 T<sub>J</sub> vs. Frequency (IRF820)  
R<sub>GATE</sub> = 33Ω, V<sub>CC</sub> = 15V

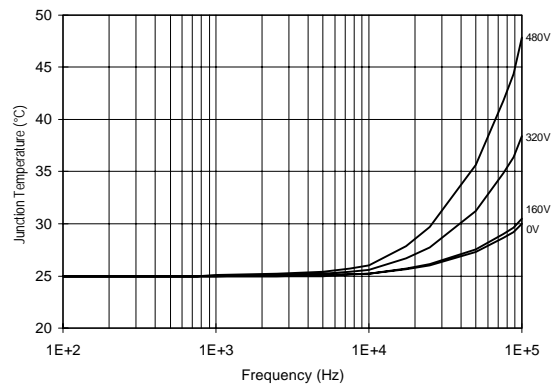


Figure 52. IR2130/IR2132 T<sub>J</sub> vs. Frequency (IRF830)  
R<sub>GATE</sub> = 20Ω, V<sub>CC</sub> = 15V

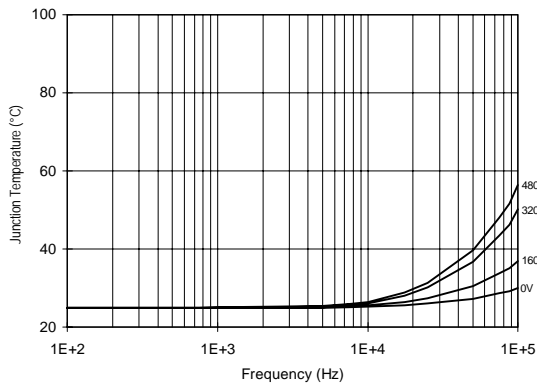


Figure 53. IR2130/IR2132 T<sub>J</sub> vs. Frequency (IRF840)  
R<sub>GATE</sub> = 15Ω, V<sub>CC</sub> = 15V

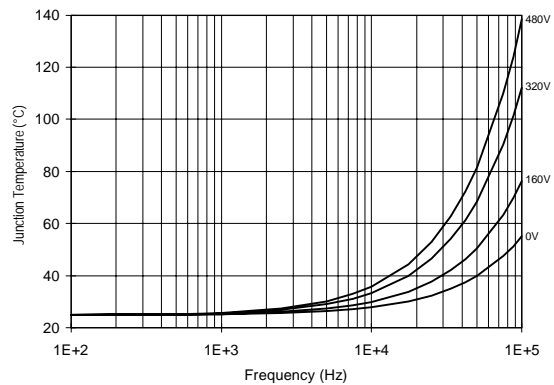
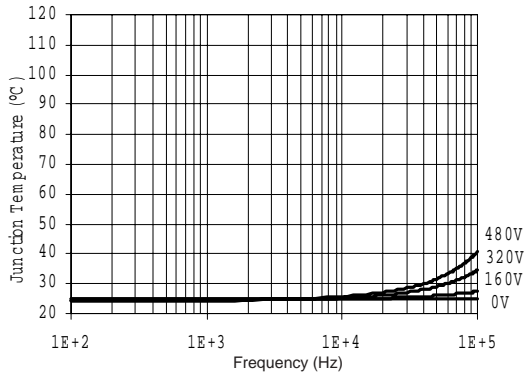
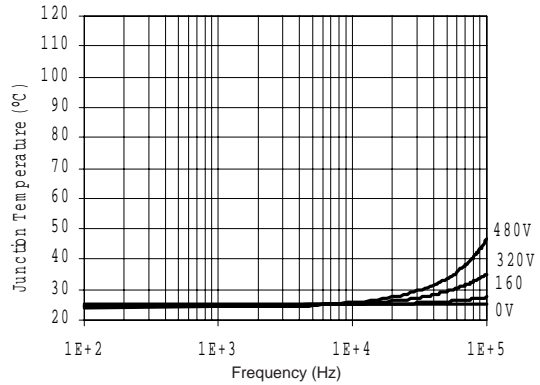


Figure 54. IR2130/IR2132 T<sub>J</sub> vs. Frequency (IRF450)  
R<sub>GATE</sub> = 10Ω, V<sub>CC</sub> = 15V

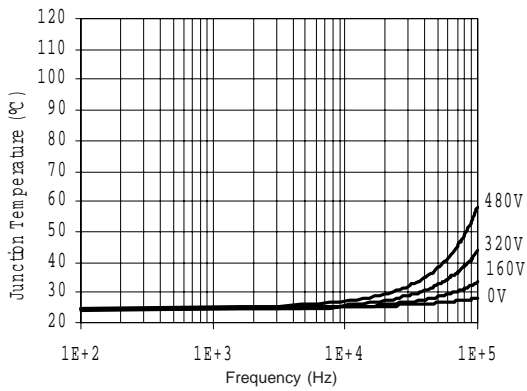
# IR2130/IR2132(J)(S) & (PbF)



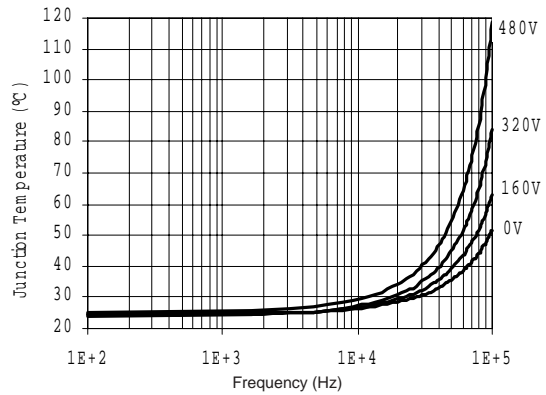
**Figure 55. IR2130J/IR2132J**  
**T<sub>J</sub> vs. Frequency (IRGPC20KD2)**  
**R<sub>GATE</sub> = 33Ω, V<sub>CC</sub> = 15V**



**Figure 56. IR2130J/IR2132J**  
**T<sub>J</sub> vs. Frequency (IRGPC30KD2)**  
**R<sub>GATE</sub> = 20Ω, V<sub>CC</sub> = 15V**



**Figure 57. IR2130J/IR2132J**  
**T<sub>J</sub> vs. Frequency (IRGPC40KD2)**  
**R<sub>GATE</sub> = 15Ω, V<sub>CC</sub> = 15V**

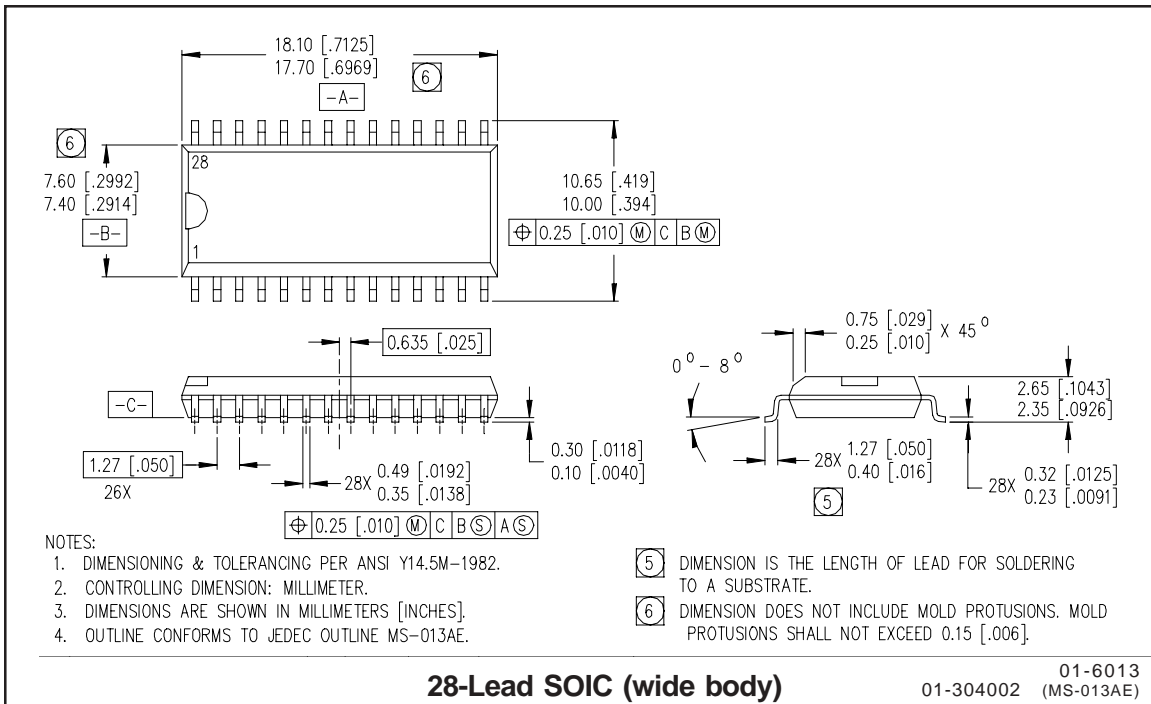
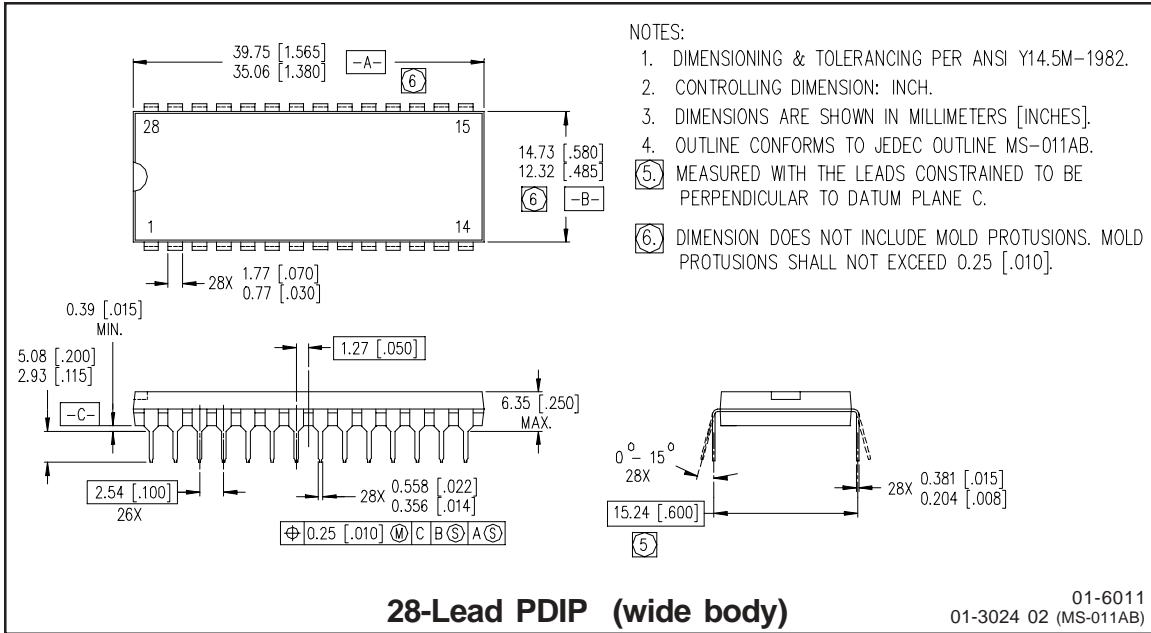


**Figure 58. IR2130J/IR2132J**  
**T<sub>J</sub> vs. Frequency (IRGPC50KD2)**  
**R<sub>GATE</sub> = 10Ω, V<sub>CC</sub> = 15V**

# IR2130/IR2132(J)(S) & (PbF)

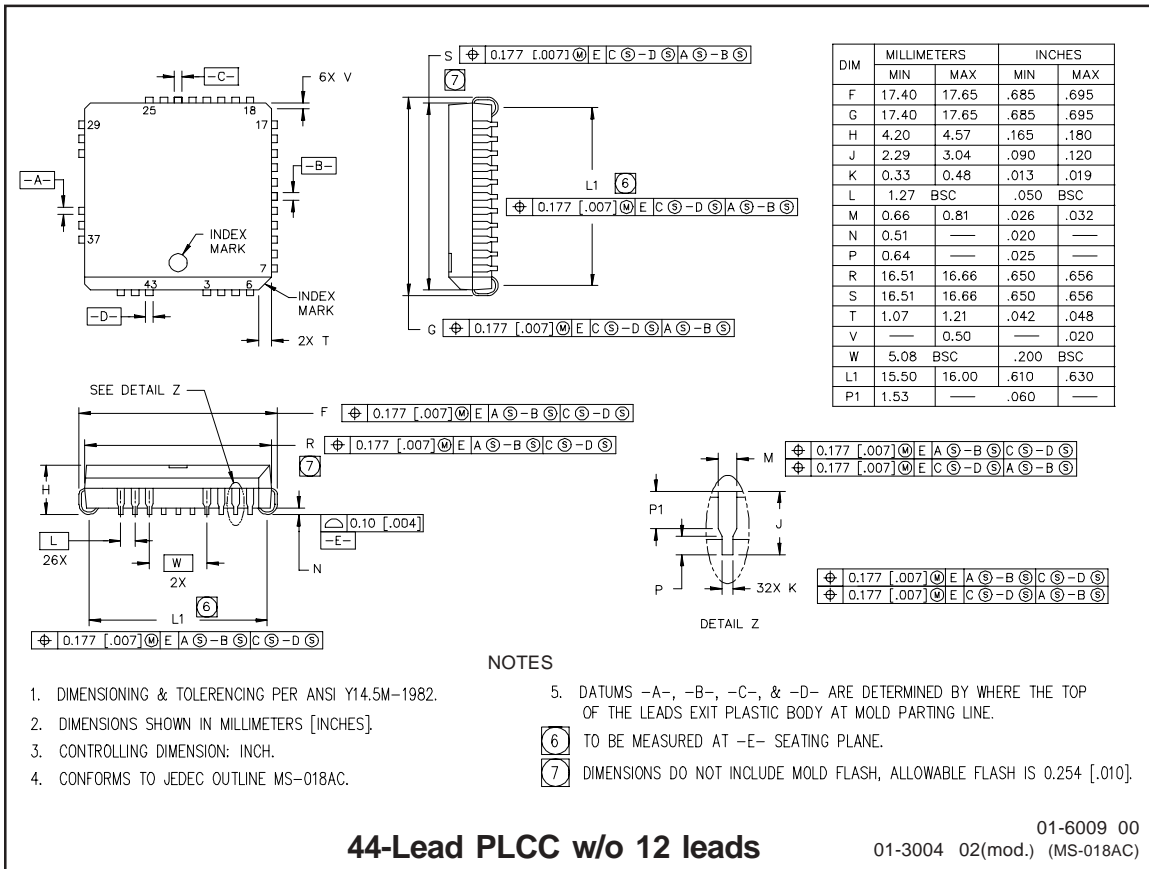
International  
IR Rectifier

## Case outlines



# IR2130/IR2132(J)(S) & (PbF)

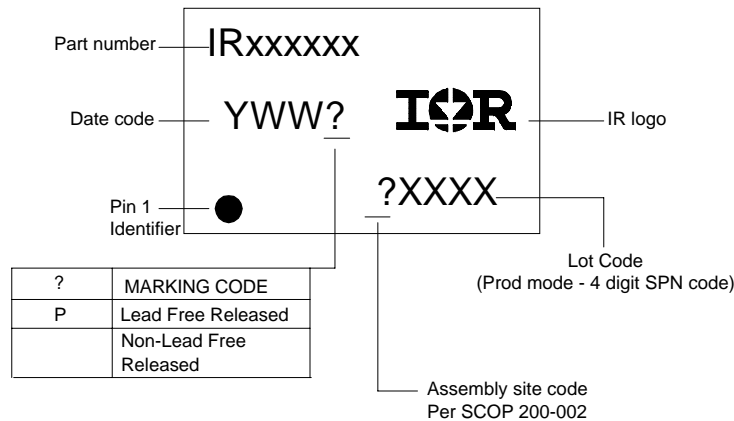
## Case outline



**44-Lead PLCC w/o 12 leads**

# IR2130/IR2132(J)(S) & (PbF)

## LEADFREE PART MARKING INFORMATION



## ORDER INFORMATION

### Basic Part (Non-Lead Free)

28-Lead PDIP IR2130 order IR2130  
 28-Lead SOIC IR2130S order IR2130S  
 28-Lead PDIP IR2132 order IR2132  
 28-Lead SOIC IR2132S order IR2132S  
 44-Lead PLCC IR2130J order IR2130J  
 44-Lead PLCC IR2132J order IR2132J

### Leadfree Part

28-Lead PDIP IR2130 order IR2130PbF  
 28-Lead SOIC IR2130S order IR2130SPbF  
 28-Lead PDIP IR2132 order IR2132PbF  
 28-Lead SOIC IR2132S order IR2132SPbF  
 44-Lead PLCC IR2130J order IR2130JPbF  
 44-Lead PLCC IR2132J order IR2132JPbF

## Looking for pricing, stock, or lifecycle information?

Click below to explore more details on WIN SOURCE:

 [View IR2130PBF on WIN SOURCE](#)

 [Infineon Technologies](#) Information

## Optimize Your Supply Chain with WIN SOURCE Solutions

-  Global Sourcing Solution
-  Obsolete Management
-  Cost Control Management
-  Shortage Management
-  Alternative Solution
-  Excess Inventory Management