



**THE DATASHEET OF  
IR2112P**



# IR2112(-1-2)(S)PbF

## HIGH AND LOW SIDE DRIVER

### Features

- Floating channel designed for bootstrap operation
- Fully operational to +600V
- Tolerant to negative transient voltage  
dV/dt immune
- Gate drive supply range from 10 to 20V
- Undervoltage lockout for both channels
- 3.3V logic compatible  
Separate logic supply range from 3.3V to 20V  
Logic and power ground  $\pm 5V$  offset
- CMOS Schmitt-triggered inputs with pull-down
- Cycle by cycle edge-triggered shutdown logic
- Matched propagation delay for both channels
- Outputs in phase with inputs

### Description

The IR2112(S) is a high voltage, high speed power MOSFET and IGBT driver with independent high and low side referenced output channels. Proprietary HVIC and latch immune CMOS technologies enable ruggedized monolithic construction. Logic inputs are compatible with standard CMOS or LSTTL outputs, down to 3.3V logic.

The output drivers feature a high pulse current buffer stage designed for minimum driver cross-conduction. Propagation delays are matched to simplify use in high frequency applications. The floating channel can be used to drive an N-channel power MOSFET or IGBT in the high side configuration which operates up to 600 volts.

### Product Summary

|                            |                 |
|----------------------------|-----------------|
| $V_{\text{OFFSET}}$        | 600V max.       |
| $I_{\text{O}+/-}$          | 200 mA / 420 mA |
| $V_{\text{OUT}}$           | 10 - 20V        |
| $t_{\text{on/off}}$ (typ.) | 125 & 105 ns    |
| Delay Matching             | 30 ns           |

### Packages

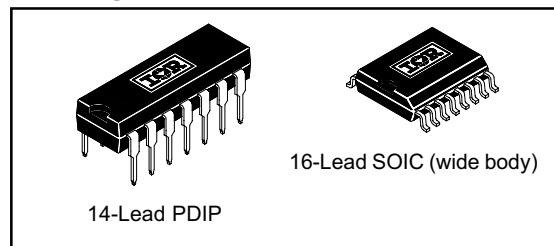

### Typical Connection

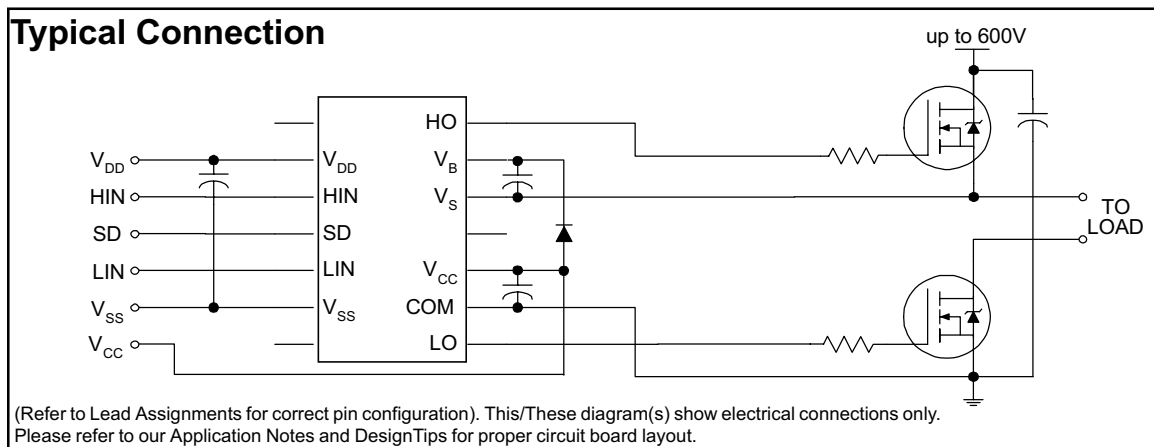

## Absolute Maximum Ratings

Absolute Maximum Ratings indicate sustained limits beyond which damage to the device may occur. All voltage parameters are absolute voltages referenced to COM. The Thermal Resistance and Power Dissipation ratings are measured under board mounted and still air conditions. Additional information is shown in Figures 28 through 35.

| Symbol              | Definition  | Min.                  | Max.                  | Units |
|---------------------|---|-----------------------|-----------------------|-------|
| V <sub>B</sub>      | High Side Floating Supply Voltage                                   | -0.3                  | 625                   | V     |
| V <sub>S</sub>      | High Side Floating Supply Offset Voltage                            | V <sub>B</sub> - 25   | V <sub>B</sub> + 0.3  |       |
| V <sub>HO</sub>     | High Side Floating Output Voltage                                   | V <sub>S</sub> - 0.3  | V <sub>B</sub> + 0.3  |       |
| V <sub>CC</sub>     | Low Side Fixed Supply Voltage                                       | -0.3                  | 25                    |       |
| V <sub>LO</sub>     | Low Side Output Voltage   | -0.3                  | V <sub>CC</sub> + 0.3 |       |
| V <sub>DD</sub>     | Logic Supply Voltage  | -0.3                  | V <sub>SS</sub> + 25  |       |
| V <sub>SS</sub>     | Logic Supply Offset Voltage   | V <sub>CC</sub> - 25  | V <sub>CC</sub> + 0.3 |       |
| V <sub>IN</sub>     | Logic Input Voltage (HIN, LIN & SD)                                 | V <sub>SS</sub> - 0.3 | V <sub>DD</sub> + 0.3 |       |
| dV <sub>S</sub> /dt | Allowable Offset Supply Voltage Transient (Figure 2)                | —                     | 50                    | V/ns  |
| P <sub>D</sub>      | Package Power Dissipation @ T <sub>A</sub> ≤ +25°C<br>(14 Lead DIP) | —                     | 1.6                   | W     |
|                     |   | (16 Lead SOIC)        | 1.25                  |       |
| R <sub>THJA</sub>   | Thermal Resistance, Junction to Ambient<br>(14 Lead DIP)            | —                     | 75                    | °C/W  |
|                     |   | (16 Lead SOIC)        | 100                   |       |
| T <sub>J</sub>      | Junction Temperature  | —                     | 150                   | °C    |
| T <sub>S</sub>      | Storage Temperature   | -55                   | 150                   |       |
| T <sub>L</sub>      | Lead Temperature (Soldering, 10 seconds)                            | —                     | 300                   |       |

## Recommended Operating Conditions

The Input/Output logic timing diagram is shown in Figure 1. For proper operation the device should be used within the recommended conditions. The V<sub>S</sub> and V<sub>SS</sub> offset ratings are tested with all supplies biased at 15V differential. Typical ratings at other bias conditions are shown in Figures 36 and 37.

| Symbol          | Definition                                 | Min.                | Max.                 | Units |
|-----------------|--|---------------------|----------------------|-------|
| V <sub>B</sub>  | High Side Floating Supply Absolute Voltage | V <sub>S</sub> + 10 | V <sub>S</sub> + 20  | V     |
| V <sub>S</sub>  | High Side Floating Supply Offset Voltage   | Note 1              | 600                  |       |
| V <sub>HO</sub> | High Side Floating Output Voltage          | V <sub>S</sub>      | V <sub>B</sub>       |       |
| V <sub>CC</sub> | Low Side Fixed Supply Voltage              | 10                  | 20                   |       |
| V <sub>LO</sub> | Low Side Output Voltage                    | 0                   | V <sub>CC</sub>      |       |
| V <sub>DD</sub> | Logic Supply Voltage                       | V <sub>SS</sub> + 3 | V <sub>SS</sub> + 20 |       |
| V <sub>SS</sub> | Logic Supply Offset Voltage                | -5 (Note 2)         | 5                    |       |
| V <sub>IN</sub> | Logic Input Voltage (HIN, LIN & SD)        | V <sub>SS</sub>     | V <sub>DD</sub>      |       |
| T <sub>A</sub>  | Ambient Temperature                        | -40                 | 125                  | °C    |

**Note 1:** Logic operational for V<sub>S</sub> of -5V to +600V. Logic state held for V<sub>S</sub> of -5V to -V<sub>BS</sub>. (Please refer to the Design Tip DT97-3 for more details).

**Note 2:** When V<sub>DD</sub> < 5V, the minimum V<sub>SS</sub> offset is limited to -V<sub>DD</sub>.

## Dynamic Electrical Characteristics

$V_{BIAS}$  ( $V_{CC}$ ,  $V_{BS}$ ,  $V_{DD}$ ) = 15V,  $C_L$  = 1000 pF,  $T_A$  = 25°C and  $V_{SS}$  = COM unless otherwise specified. The dynamic electrical characteristics are measured using the test circuit shown in Figure 3.

| Symbol    | Definition                          | Figure | Min. | Typ. | Max. | Units | Test Conditions |
|-----------|-------------------------------------|--------|------|------|------|-------|-----------------|
| $t_{on}$  | Turn-On Propagation Delay           | 7      | —    | 125  | 180  | ns    | $V_S = 0V$      |
| $t_{off}$ | Turn-Off Propagation Delay          | 8      | —    | 105  | 160  |       | $V_S = 600V$    |
| $t_{sd}$  | Shutdown Propagation Delay          | 9      | —    | 105  | 160  |       | $V_S = 600V$    |
| $t_r$     | Turn-On Rise Time                   | 10     | —    | 80   | 130  |       |                 |
| $t_f$     | Turn-Off Fall Time                  | 11     | —    | 40   | 65   |       |                 |
| MT        | Delay Matching, HS & LS Turn-On/Off | —      | —    | —    | 30   |       |                 |

## Static Electrical Characteristics

$V_{BIAS}$  ( $V_{CC}$ ,  $V_{BS}$ ,  $V_{DD}$ ) = 15V,  $T_A$  = 25°C and  $V_{SS}$  = COM unless otherwise specified. The  $V_{IH}$ ,  $V_{TH}$  and  $I_{IN}$  parameters are referenced to  $V_{SS}$  and are applicable to all three logic input leads: HIN, LIN and SD. The  $V_O$  and  $I_O$  parameters are referenced to COM and are applicable to the respective output leads: HO or LO.

| Symbol      | Definition  | Figure | Min. | Typ. | Max. | Units   | Test Conditions                                   |
|-------------|---|--------|------|------|------|---------|---|
| $V_{IH}$    | Logic "1" Input Voltage                               | 12     | 9.5  | —    | —    | V       |   |
| $V_{IL}$    | Logic "0" Input Voltage                               | 13     | —    | —    | 6.0  |         |   |
| $V_{OH}$    | High Level Output Voltage, $V_{BIAS} - V_O$           | 14     | —    | —    | 100  | mV      | $I_O = 0A$  |
| $V_{OL}$    | Low Level Output Voltage, $V_O$                       | 15     | —    | —    | 100  |         | $I_O = 0A$  |
| $I_{LK}$    | Offset Supply Leakage Current                         | 16     | —    | —    | 50   | $\mu A$ | $V_B = V_S = 600V$                                |
| $I_{QBS}$   | Quiescent $V_{BS}$ Supply Current                     | 17     | —    | 25   | 60   |         | $V_{IN} = 0V$ or $V_{DD}$                         |
| $I_{QCC}$   | Quiescent $V_{CC}$ Supply Current                     | 18     | —    | 80   | 180  |         | $V_{IN} = 0V$ or $V_{DD}$                         |
| $I_{QDD}$   | Quiescent $V_{DD}$ Supply Current                     | 19     | —    | 2.0  | 5.0  |         | $V_{IN} = 0V$ or $V_{DD}$                         |
| $I_{IN+}$   | Logic "1" Input Bias Current                          | 20     | —    | 20   | 40   |         | $V_{IN} = V_{DD}$                                 |
| $I_{IN-}$   | Logic "0" Input Bias Current                          | 21     | —    | —    | 1.0  |         | $V_{IN} = 0V$                                     |
| $V_{BSUV+}$ | $V_{BS}$ Supply Undervoltage Positive Going Threshold | 22     | 7.4  | 8.5  | 9.6  | V       |   |
| $V_{BSUV-}$ | $V_{BS}$ Supply Undervoltage Negative Going Threshold | 23     | 7.0  | 8.1  | 9.2  |         |   |
| $V_{CCUV+}$ | $V_{CC}$ Supply Undervoltage Positive Going Threshold | 24     | 7.6  | 8.6  | 9.6  |         |   |
| $V_{CCUV-}$ | $V_{CC}$ Supply Undervoltage Negative Going Threshold | 25     | 7.2  | 8.2  | 9.2  |         |   |
| $I_{O+}$    | Output High Short Circuit Pulsed Current              | 26     | 200  | 250  | —    | mA      | $V_O = 0V, V_{IN} = V_{DD}$<br>$PW \leq 10 \mu s$ |
| $I_{O-}$    | Output Low Short Circuit Pulsed Current               | 27     | 420  | 500  | —    |         | $V_O = 15V, V_{IN} = 0V$<br>$PW \leq 10 \mu s$    |

## Functional Block Diagram

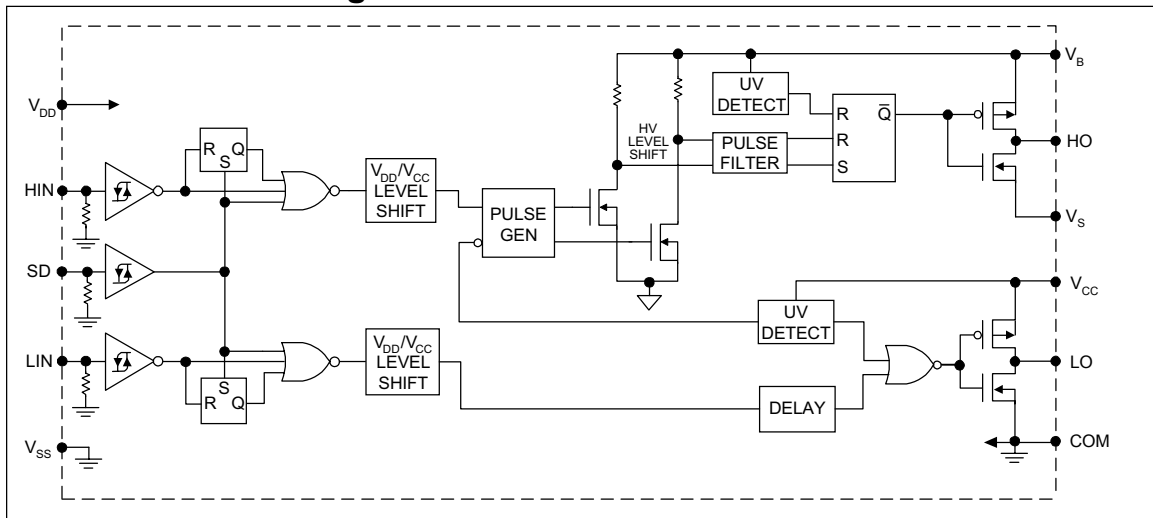

## Lead Definitions

| Symbol          | Description   |
|-----------------|---|
| V <sub>DD</sub> | Logic supply  |
| HIN             | Logic input for high side gate driver output (HO), in phase |
| SD              | Logic input for shutdown                                    |
| LIN             | Logic input for low side gate driver output (LO), in phase  |
| V <sub>SS</sub> | Logic ground  |
| V <sub>B</sub>  | High side floating supply                                   |
| HO              | High side gate drive output                                 |
| V <sub>S</sub>  | High side floating supply return                            |
| V <sub>CC</sub> | Low side supply   |
| LO              | Low side gate drive output                                  |
| COM             | Low side return   |

## Lead Assignments

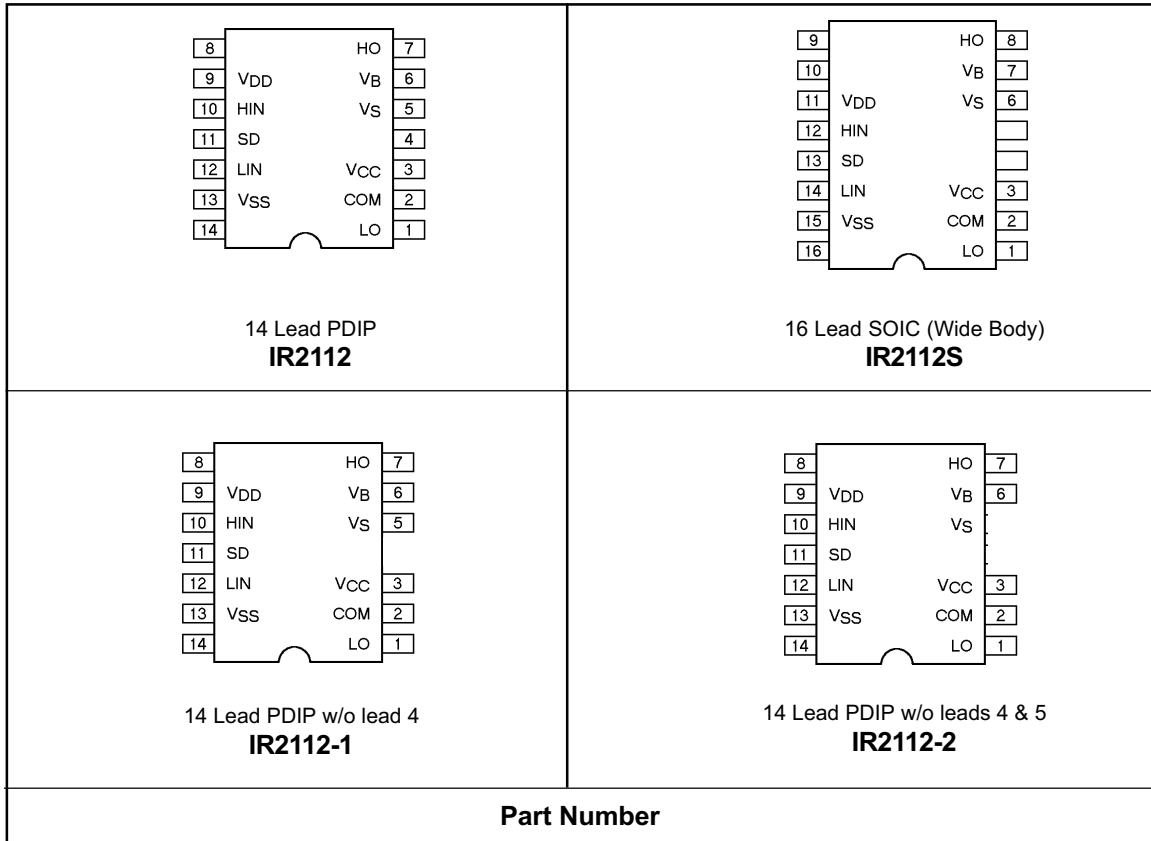

# IR2112(-1-2)(S)PbF

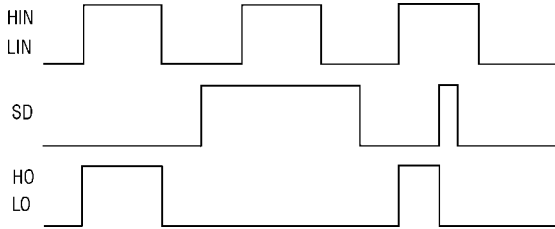

Figure 1. Input/Output Timing Diagram

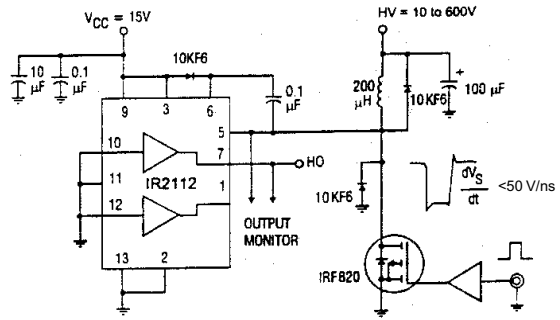

Figure 2. Floating Supply Voltage Transient Test Circuit

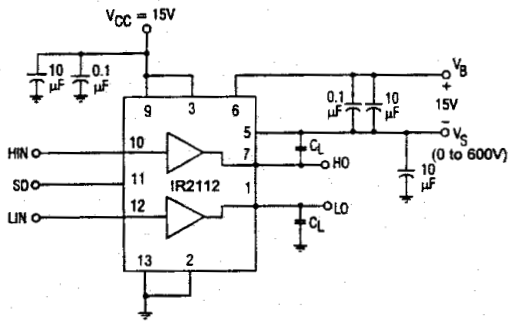

Figure 3. Switching Time Test Circuit

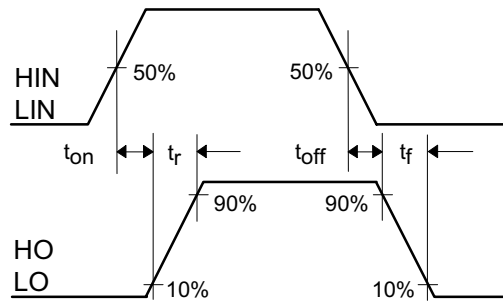

Figure 4. Switching Time Waveform Definition

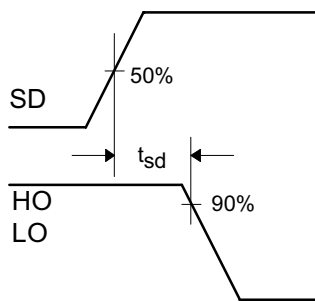

Figure 5. Shutdown Waveform Definitions

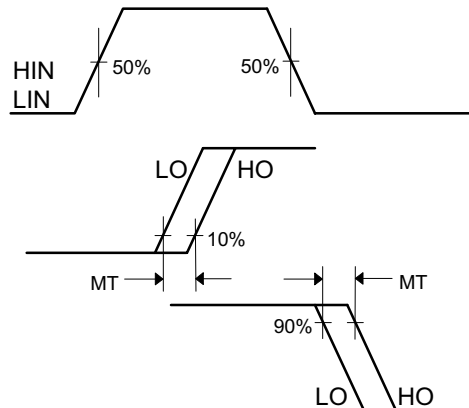

Figure 6. Delay Matching Waveform Definitions

# IR2112(-1-2)(S)PbF

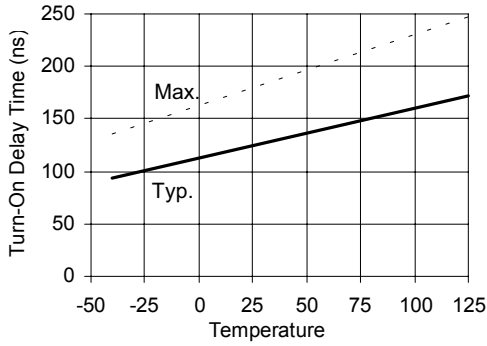

Figure 7A. Turn-On Time vs. Temperature

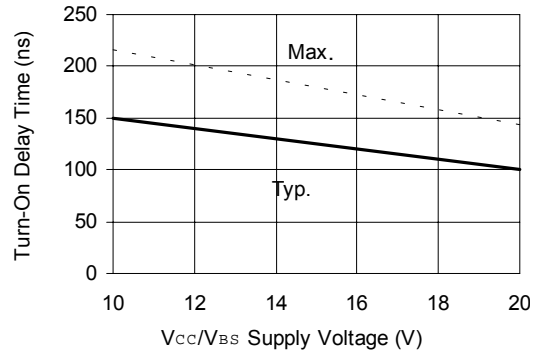

Figure 7B. Turn-On Time vs. V<sub>CC</sub>/V<sub>BS</sub> Supply Voltage

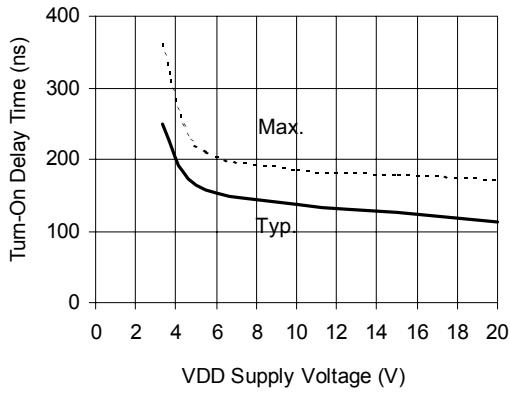

Figure 7C. Turn-On Time vs. V<sub>DD</sub> Supply Voltage

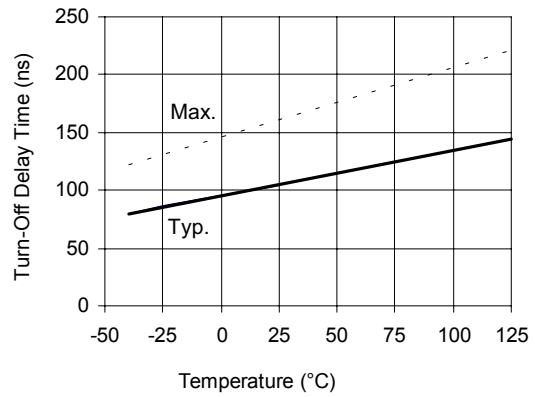

Figure 8A. Turn-Off Time vs. Temperature

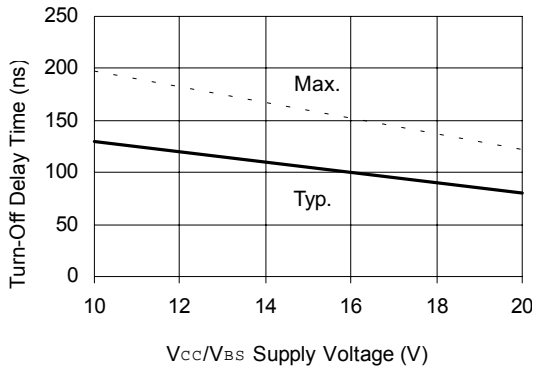

Figure 8B. Turn-Off Time vs. V<sub>CC</sub>/V<sub>BS</sub> Supply Voltage

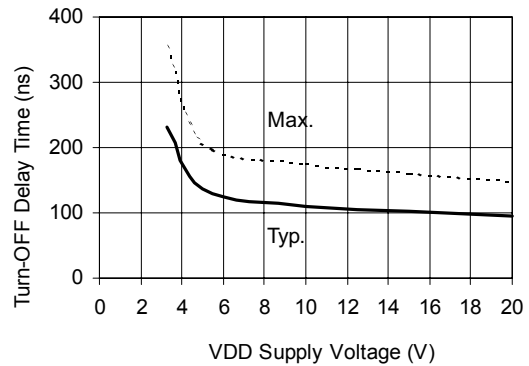

Figure 8C. Turn-Off Time vs. V<sub>DD</sub> Supply Voltage

# IR2112(-1-2)(S)PbF

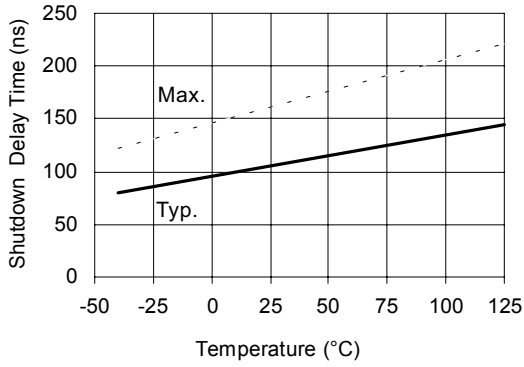

Figure 9A. Shutdown Time vs. Temperature

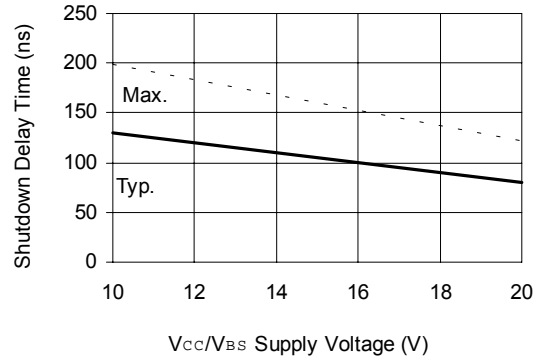

Figure 9B. Shutdown Delay Time vs. V<sub>cc</sub>/V<sub>BS</sub> Supply Voltage

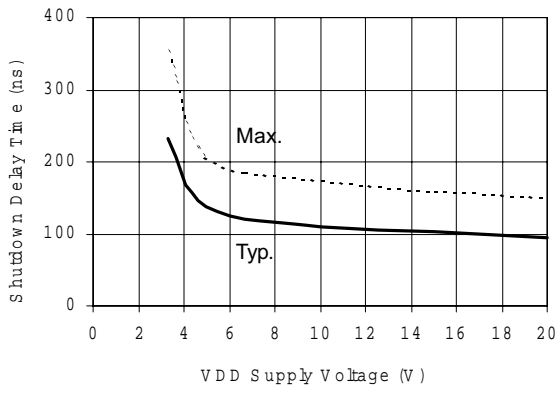

Figure 9C. Shutdown Time vs. V<sub>DD</sub> Supply Voltage

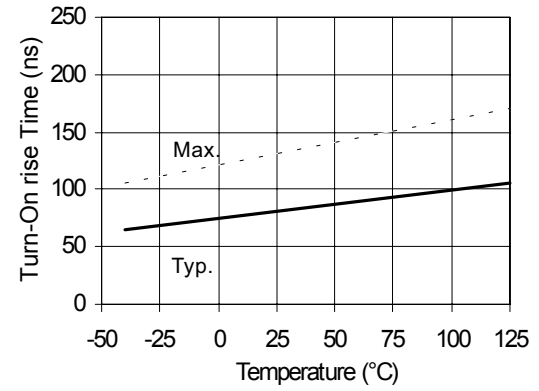

Figure 10A. Turn-On Rise Time vs. Temperature

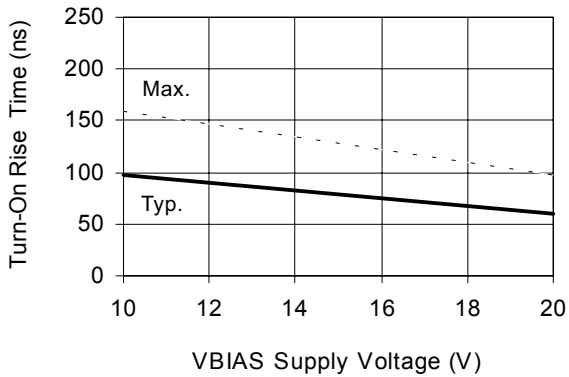

Figure 10B. Turn-On Rise Time vs. Voltage

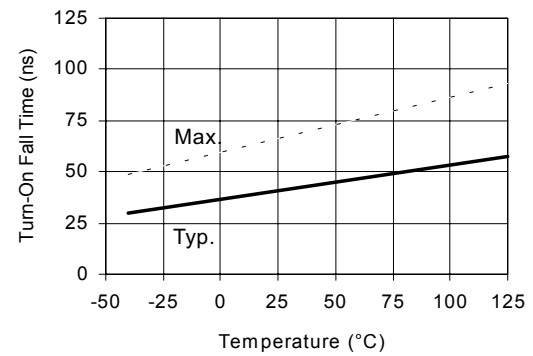

Figure 11A Turn-On Fall Time vs. Temperature

# IR2112(-1-2)(S)PbF

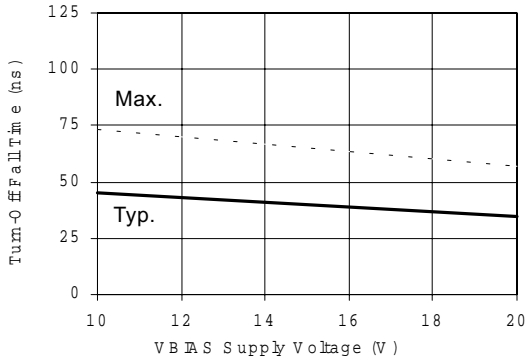

Figure 11B. Turn-Off Fall Time vs. Voltage

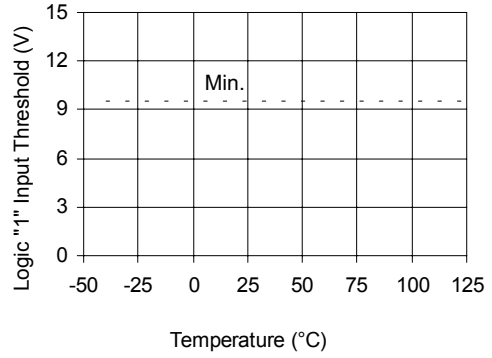

Figure 12A. Logic "1" Input Threshold vs. Temperature

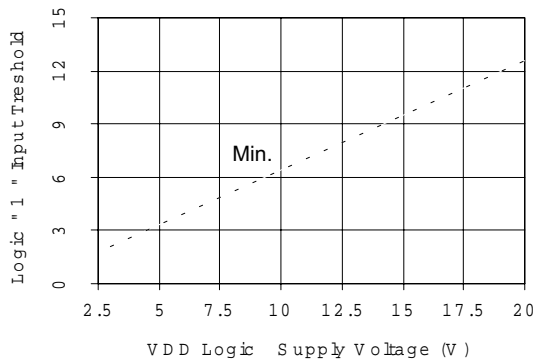

Figure 12B. Logic "1" Input Threshold vs. Voltage

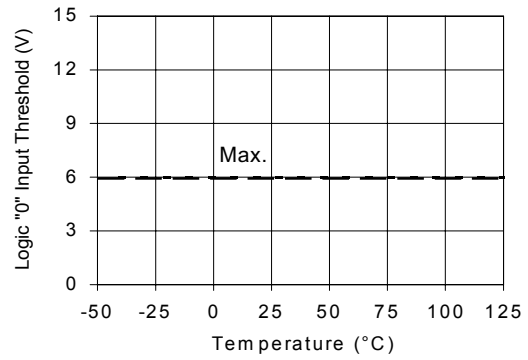

Figure 13A. Logic "0" Input Threshold vs. Temperature

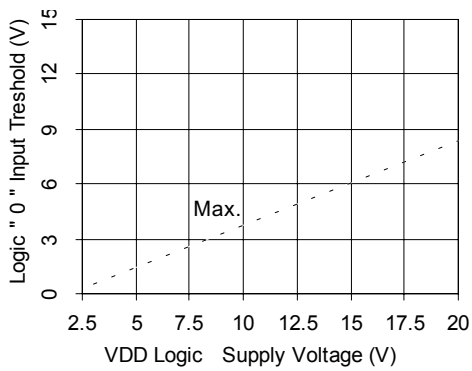

Figure 13B. Logic "0" Input Threshold vs. Voltage

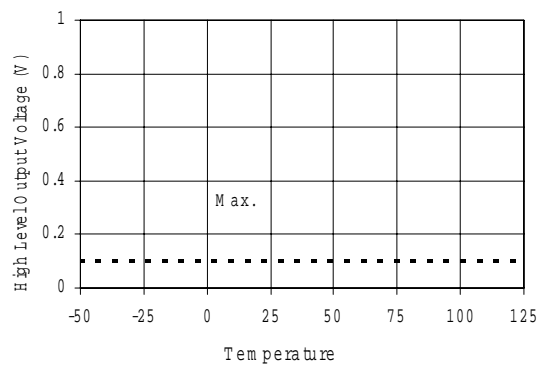

Figure 14A. High Level Output vs. Temperature

# IR2112(-1-2)(S)PbF

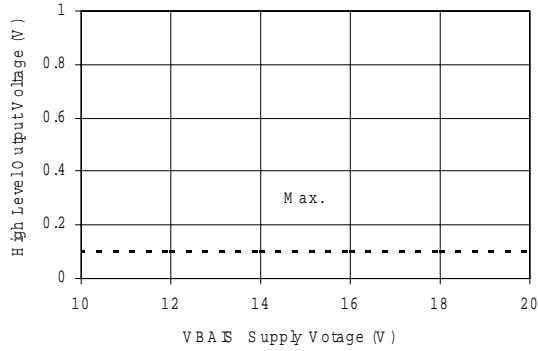

Figure 14B. High Level Output vs. Voltage

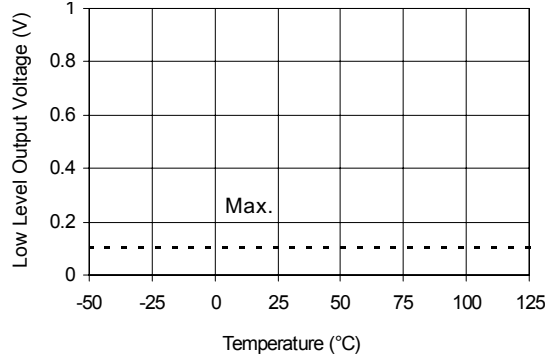

Figure 15A. Low Level Output vs. Temperature

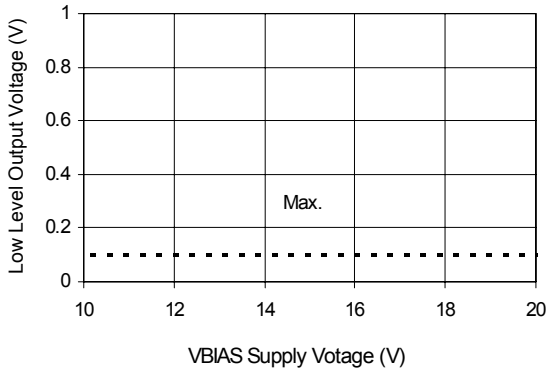

Figure 15B. Low Level Output vs. Voltage

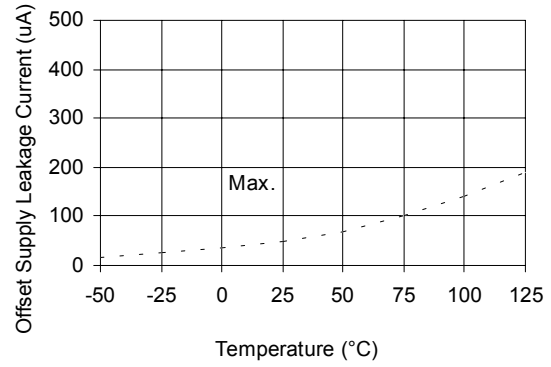

Figure 16A. Offset Supply Current vs. Temperature

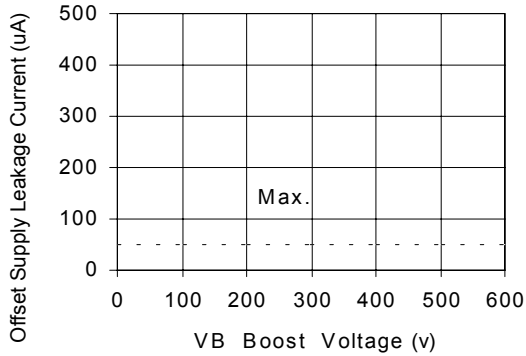

Figure 16B. Offset Supply Current vs. Voltage

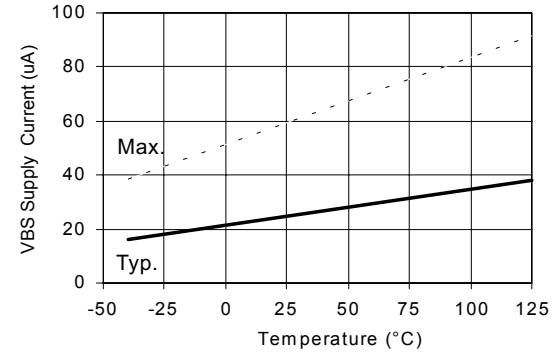

Figure 17A. Vbs Supply Current vs. Temperature

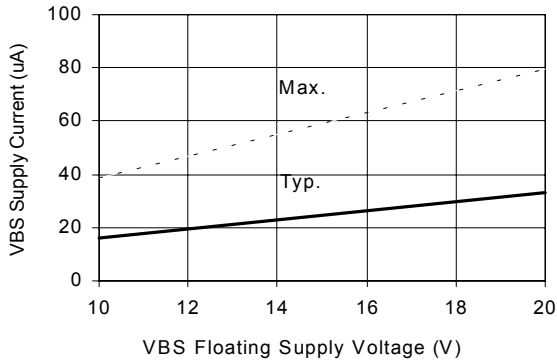

Figure 17B. VBS Supply Current vs. Voltage

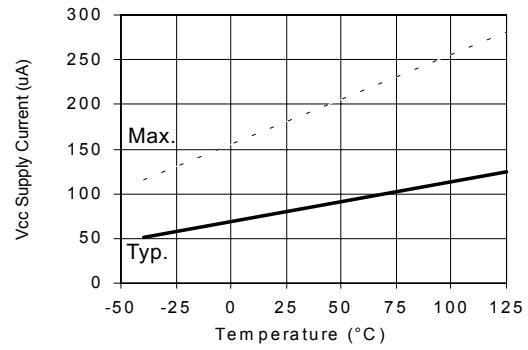

Figure 18A. VCC Supply Current vs. Temperature

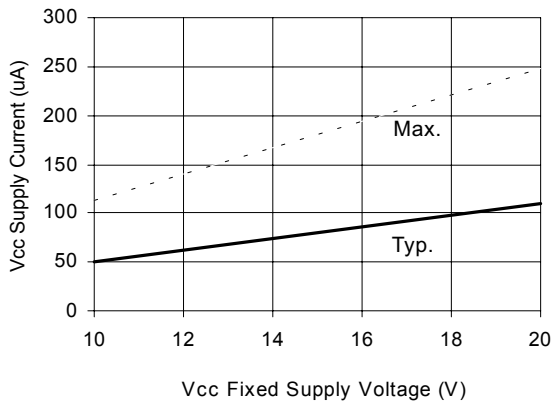

Figure 18B. VCC Supply Current vs. Voltage

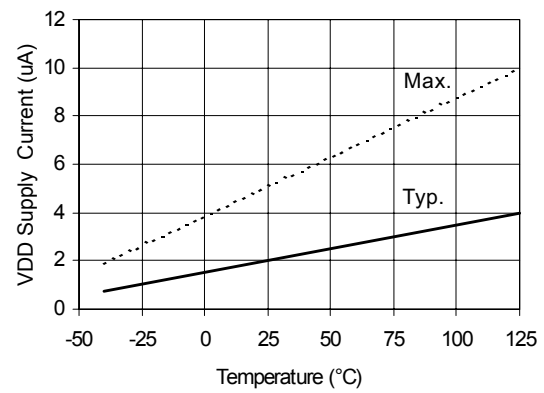

Figure 19A. VDD Supply Current vs. Temperature

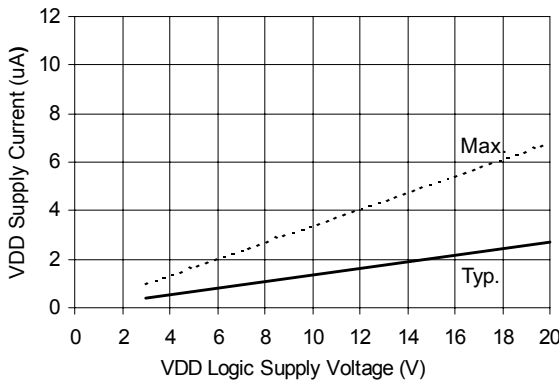

Figure 19B. VDD Supply Current vs. VDD Voltage

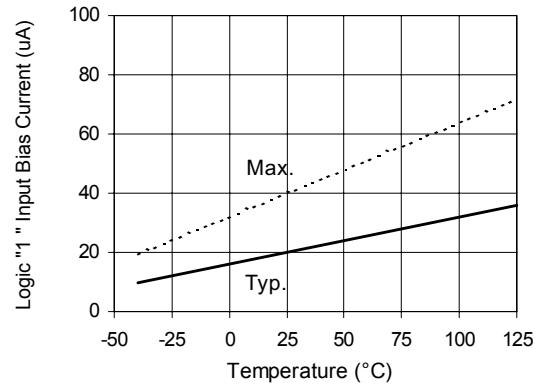

Figure 20A. Logic "1" Input Current vs. Temperature

# IR2112(-1-2)(S)PbF

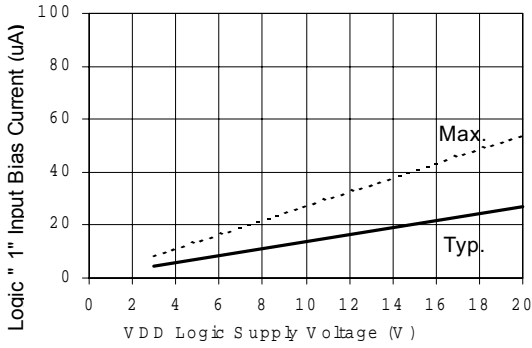

Figure 20B. Logic "1" Input Current vs. V<sub>DD</sub> Voltage

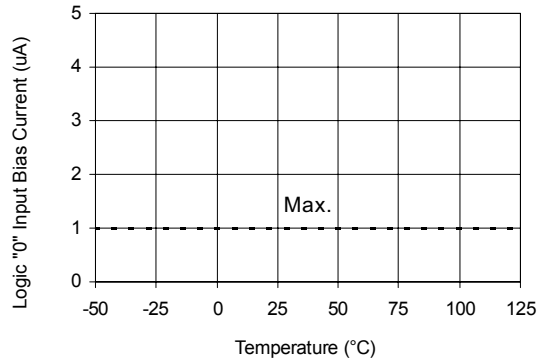

Figure 21A. Logic "0" Input Current vs. Temperature

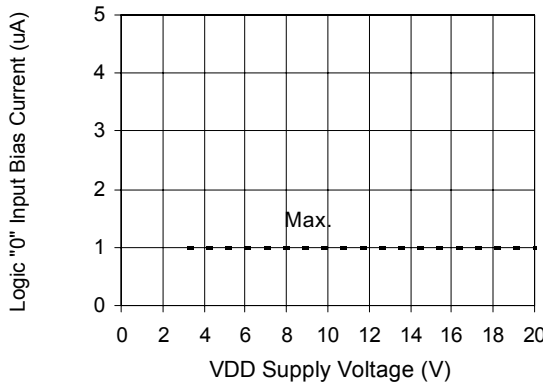

Figure 21B. Logic "0" Input Current vs. V<sub>DD</sub> Voltage

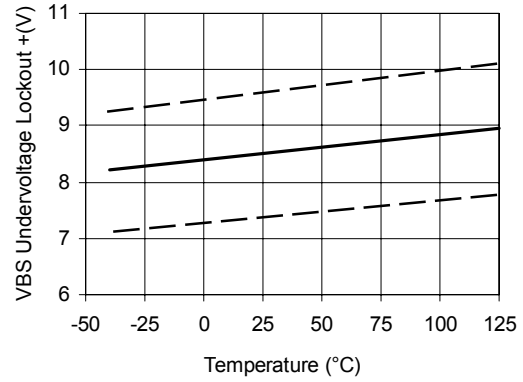

Figure 22. V<sub>bs</sub> Undervoltage (+) vs. Temperature

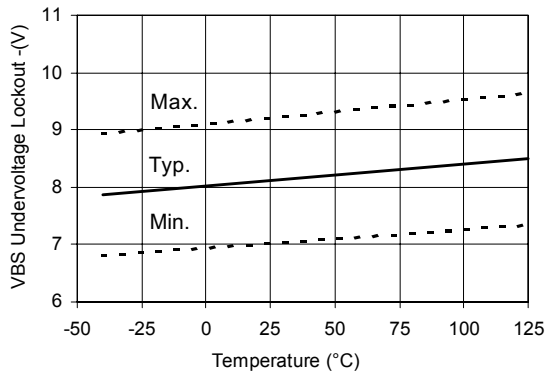

Figure 23. V<sub>bs</sub> Undervoltage (-) vs. Temperature

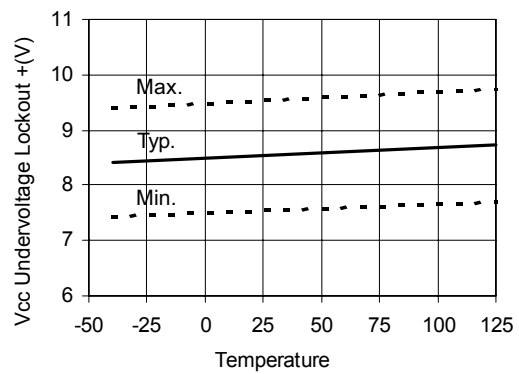

Figure 24. V<sub>cc</sub> Undervoltage (-) vs. Temperature

# IR2112(-1-2)(S)PbF

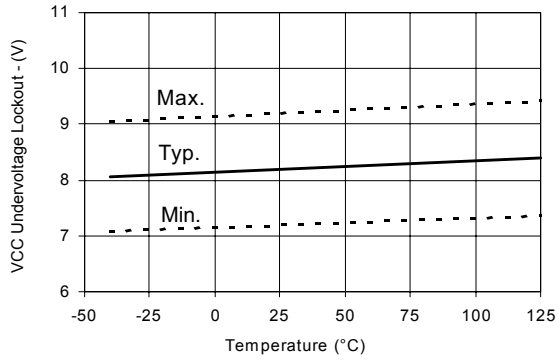

Figure 25. Vcc Undervoltage (-) vs. Temperature

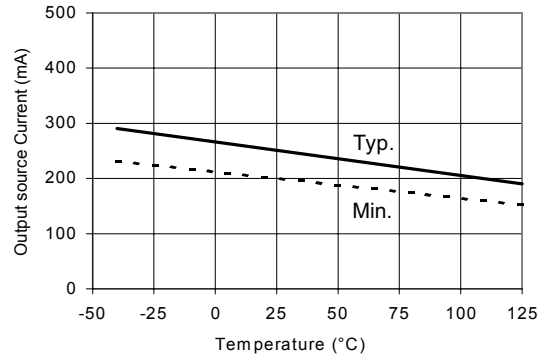

Figure 26A. Output Source Current vs. Temperature

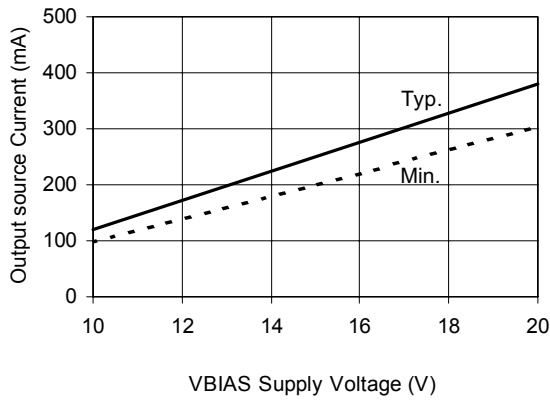

Figure 26B. Output Source Current vs. Voltage

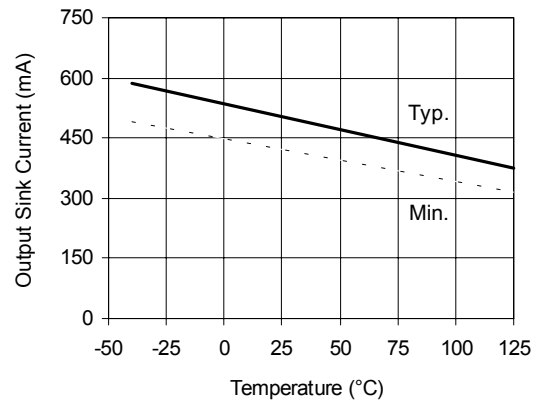

Figure 27A. Output Sink Current vs. Temperature

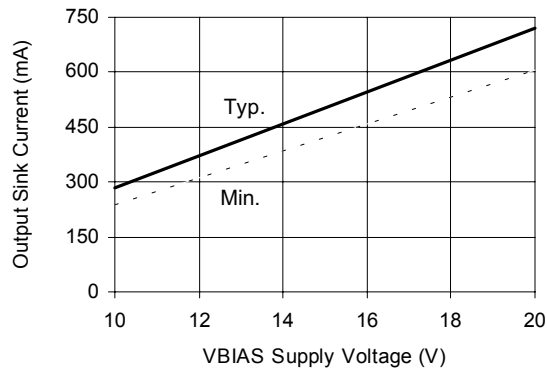
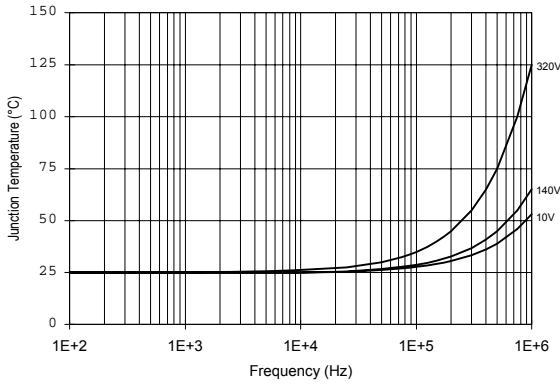
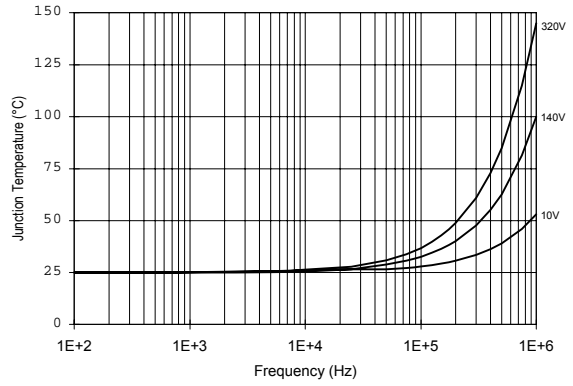

Figure 27B. Output Sink Current vs. Voltage

# IR2112(-1-2)(S)PbF



**Figure 28. IR2112 T<sub>J</sub> vs. Frequency (IRFBC20)**  
R<sub>GATE</sub> = 33Ω, V<sub>CC</sub> = 15V



**Figure 29. IR2112 T<sub>J</sub> vs. Frequency (IRFBC30)**  
R<sub>GATE</sub> = 22Ω, V<sub>CC</sub> = 15V

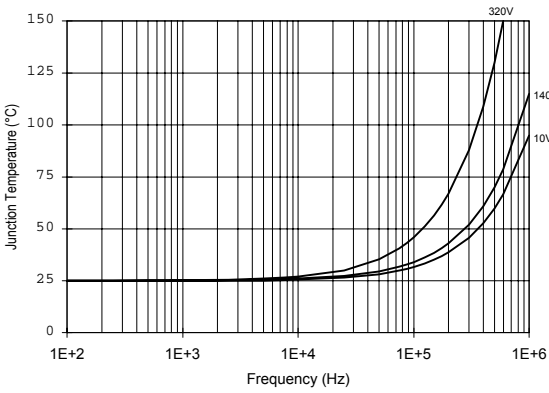

**Figure 30. IR2112 T<sub>J</sub> vs. Frequency (IRFBC40)**  
R<sub>GATE</sub> = 15Ω, V<sub>CC</sub> = 15V

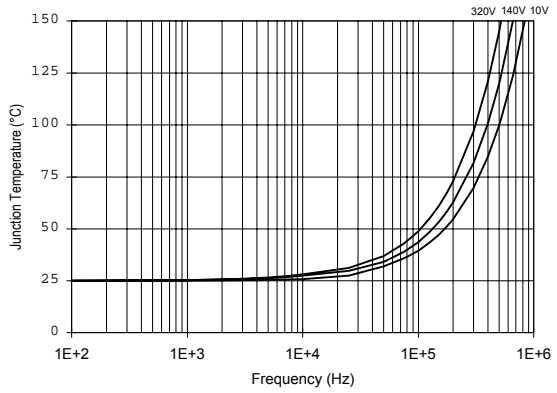

**Figure 31. IR2112 T<sub>J</sub> vs. Frequency (IRFPE50)**  
R<sub>GATE</sub> = 10Ω, V<sub>CC</sub> = 15V

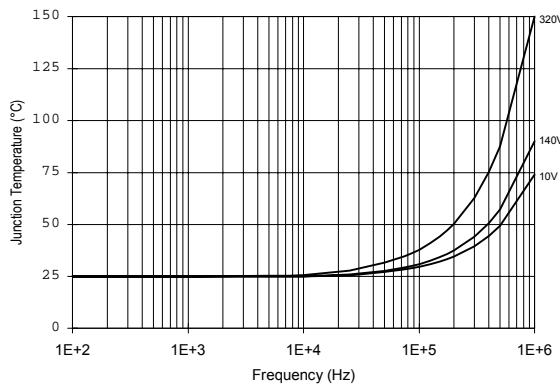

**Figure 32. IR2112S T<sub>J</sub> vs. Frequency (IRFBC20)**  
R<sub>GATE</sub> = 33Ω, V<sub>CC</sub> = 15V

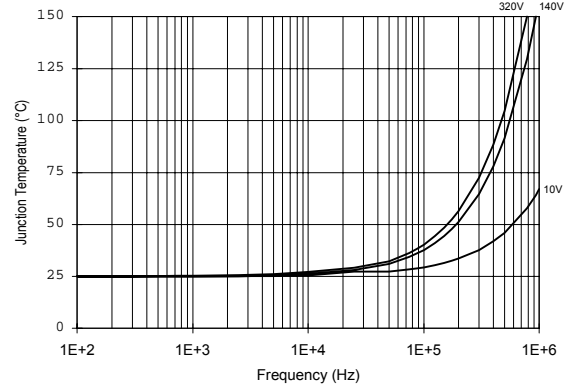

**Figure 33. IR2112S T<sub>J</sub> vs. Frequency (IRFBC30)**  
R<sub>GATE</sub> = 22Ω, V<sub>CC</sub> = 15V

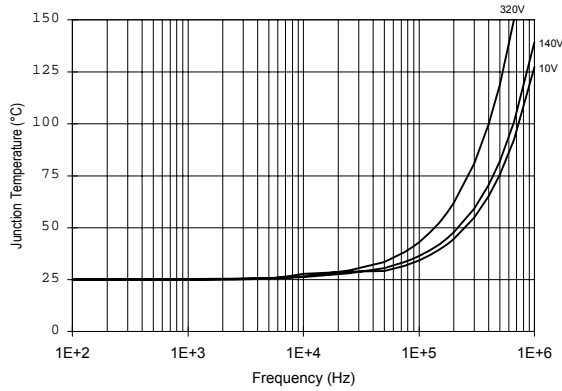

**Figure 34. IR2112S T<sub>J</sub> vs. Frequency (IRFBC40)**  
R<sub>GATE</sub> = 15Ω, V<sub>CC</sub> = 15V

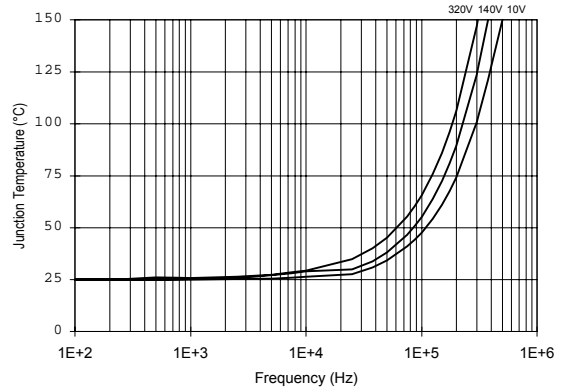

**Figure 35. IR2112S T<sub>J</sub> vs. Frequency (IRFPE50)**  
R<sub>GATE</sub> = 10Ω, V<sub>CC</sub> = 15V

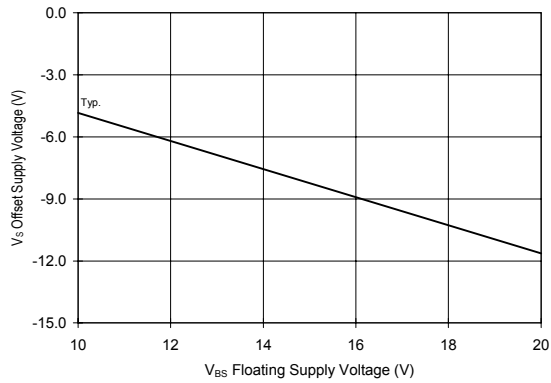

**Figure 36. Maximum Vs Negative Offset vs. V<sub>BS</sub> Supply Voltage**

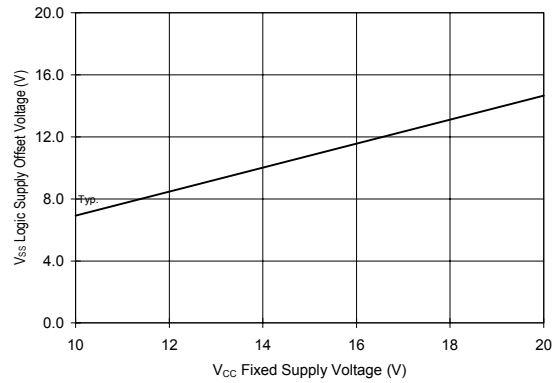
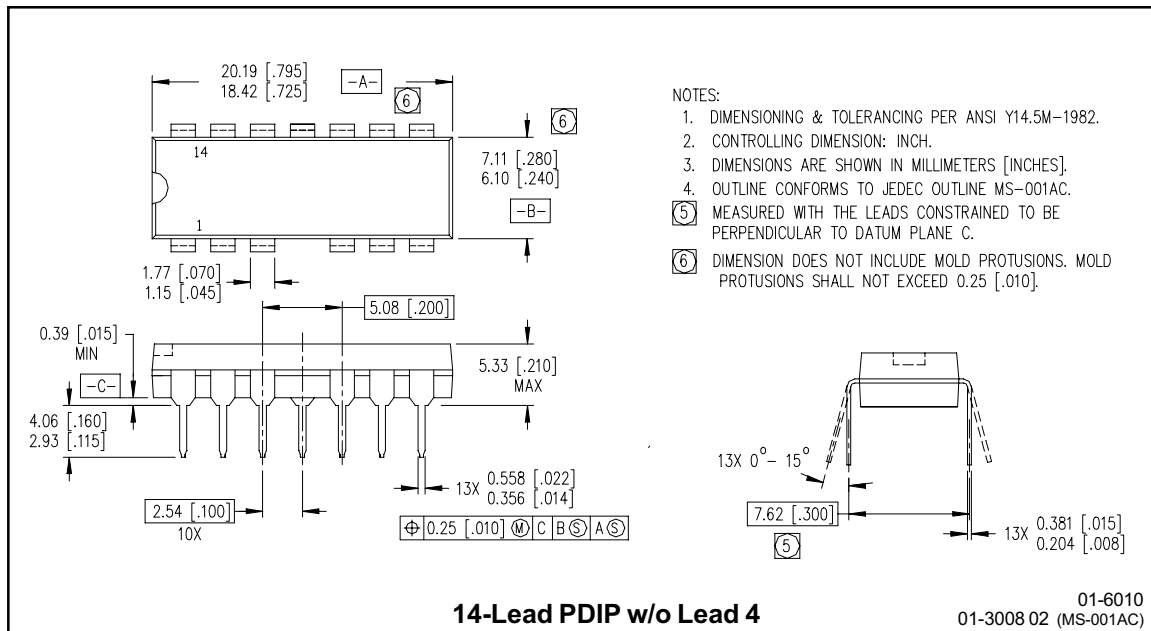
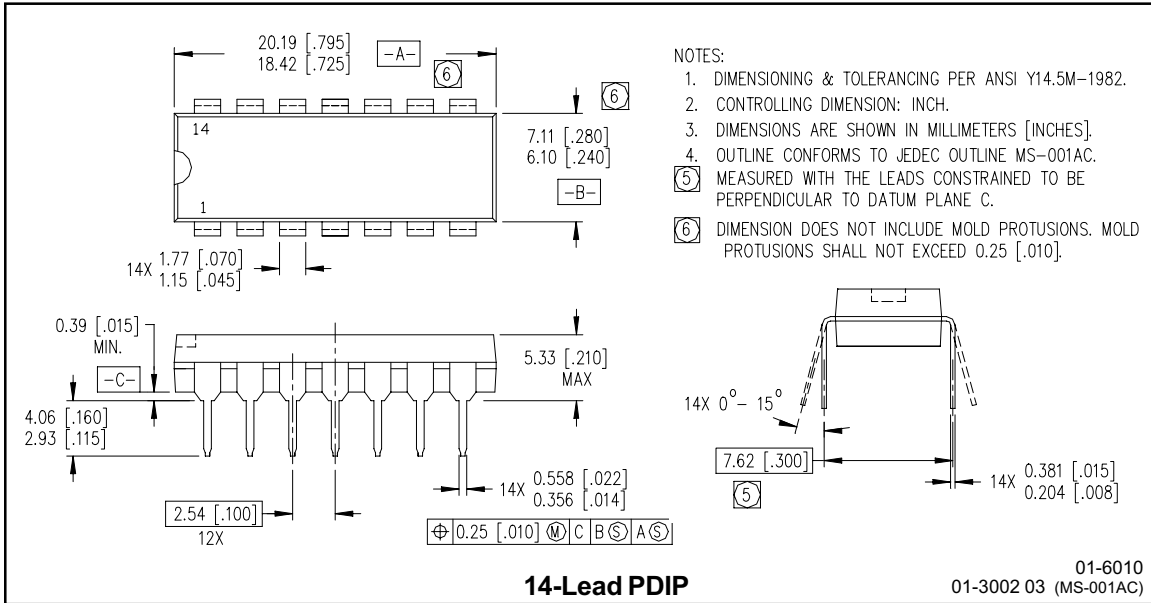

**Figure 37. Maximum V<sub>SS</sub> Positive Offset vs. V<sub>CC</sub> Supply Voltage**

# IR2112(-1-2)(S)PbF

International  
**IR** Rectifier

## Case outline



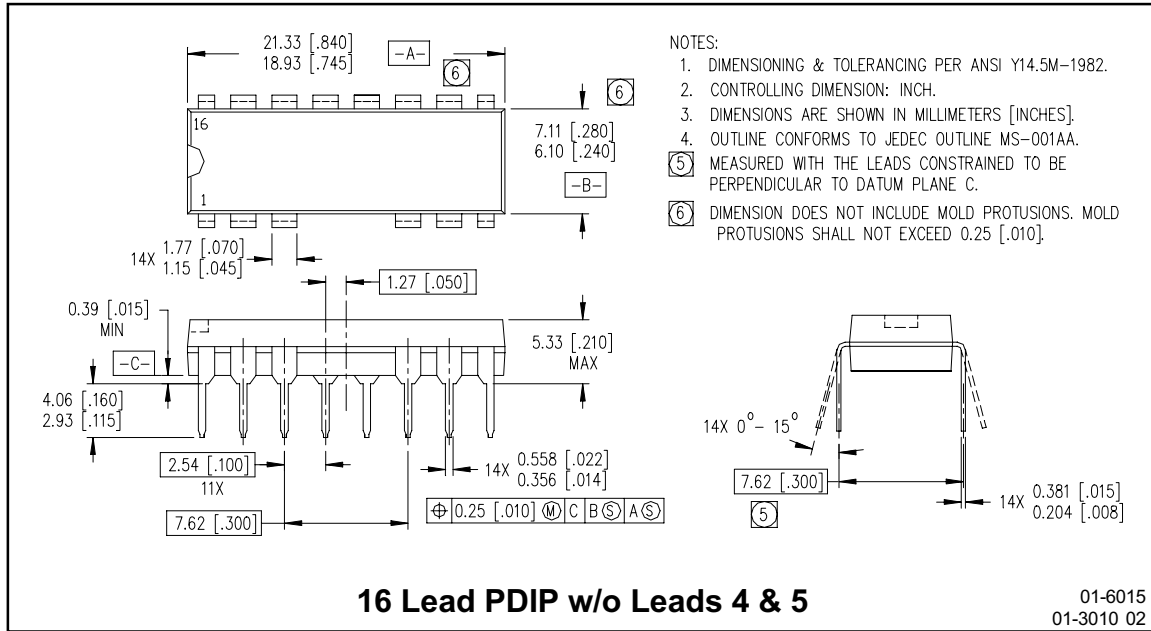

NOTES:

1. DIMENSIONING & TOLERANCING PER ANSI Y14.5M-1982.
2. CONTROLLING DIMENSION: INCH.
3. DIMENSIONS ARE SHOWN IN MILLIMETERS [INCHES].
4. OUTLINE CONFORMS TO JEDEC OUTLINE MS-001AA.
- ⑤ MEASURED WITH THE LEADS CONSTRAINED TO BE PERPENDICULAR TO DATUM PLANE C.
- ⑥ DIMENSION DOES NOT INCLUDE MOLD PROTUSIONS. MOLD PROTUSIONS SHALL NOT EXCEED 0.25 [.010].

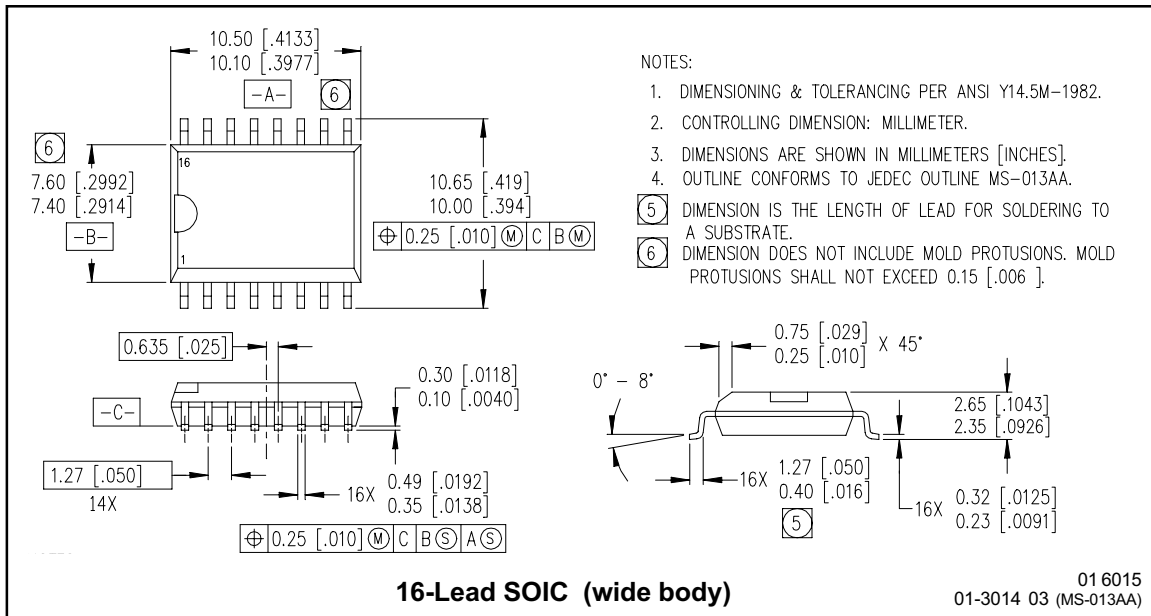

NOTES:

1. DIMENSIONING & TOLERANCING PER ANSI Y14.5M-1982.
2. CONTROLLING DIMENSION: MILLIMETER.
3. DIMENSIONS ARE SHOWN IN MILLIMETERS [INCHES].
4. OUTLINE CONFORMS TO JEDEC OUTLINE MS-013AA.
- ⑤ DIMENSION IS THE LENGTH OF LEAD FOR SOLDERING TO A SUBSTRATE.
- ⑥ DIMENSION DOES NOT INCLUDE MOLD PROTUSIONS. MOLD PROTUSIONS SHALL NOT EXCEED 0.15 [.006].

# IR2112(-1-2)(S)PbF

## LEADFREE PART MARKING INFORMATION

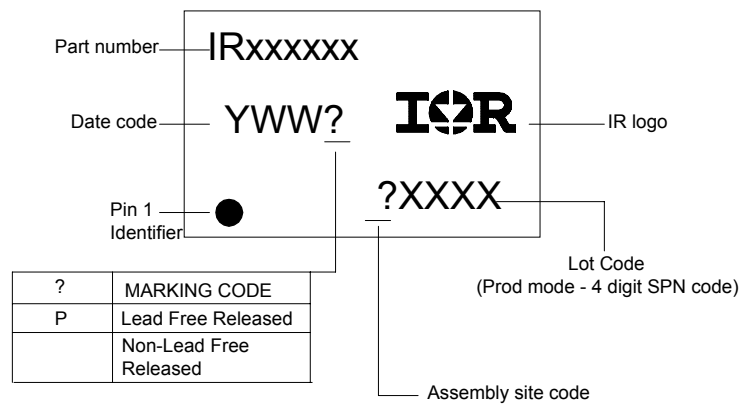



## ORDER INFORMATION

**Part only available Leadfree**

14-Lead PDIP IR2112 order IR2112PbF  
14-Lead PDIP IR2112-1 order IR2112-1PbF  
14-Lead PDIP IR2112-2 order IR2112-2PbF  
16-Lead SOIC IR2112S order IR2112SPbF

## Looking for pricing, stock, or lifecycle information?

Click below to explore more details on WIN SOURCE:

-  [View IR2112P on WIN SOURCE](#)
-  [Infineon Technologies](#) Information

## Optimize Your Supply Chain with WIN SOURCE Solutions

-  Global Sourcing Solution
-  Obsolete Management
-  Cost Control Management
-  Shortage Management
-  Alternative Solution
-  Excess Inventory Management