



**THE DATASHEET OF
IR2111PBF**



IR2111(S) & (PbF)

HALF-BRIDGE DRIVER

Features

- Floating channel designed for bootstrap operation
Fully operational to +600V
Tolerant to negative transient voltage
dV/dt immune
- Gate drive supply range from 10 to 20V
- Undervoltage lockout for both channels
- CMOS Schmitt-triggered inputs with pull-down
- Matched propagation delay for both channels
- Internally set deadtime
- High side output in phase with input
- Also available LEAD-FREE

Description

The IR2111(S) is a high voltage, high speed power MOSFET and IGBT driver with dependent high and low side referenced output channels designed for half-bridge applications. Proprietary HVIC and latch immune CMOS technologies enable ruggedized monolithic construction. Logic input is compatible with standard CMOS outputs. The output drivers feature a high pulse current buffer stage designed for minimum driver cross-conduction. Internal deadtime is provided to avoid shoot-through in the output half-bridge. The floating channel can be used to drive an N-channel power MOSFET or IGBT in the high side configuration which operates up to 600 volts.

Product Summary

V_{OFFSET}	600V max.
$I_{\text{O}+/-}$	200 mA / 420 mA
V_{OUT}	10 - 20V
$t_{\text{on/off}}$ (typ.)	750 & 150 ns
Deadtime (typ.)	650 ns

Packages

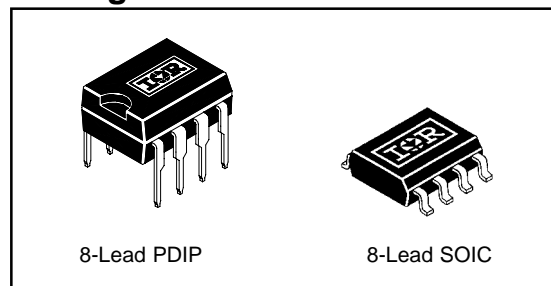

Typical Connection

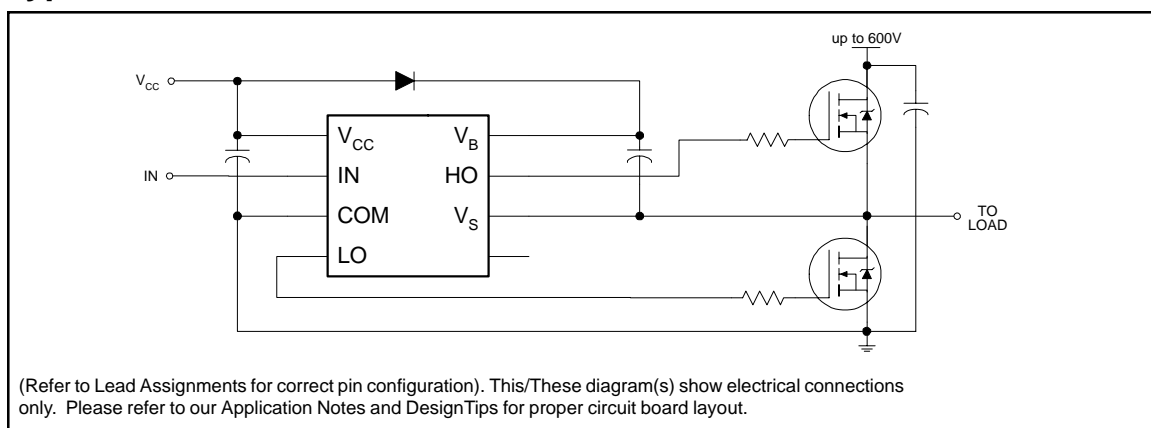

Absolute Maximum Ratings

Absolute maximum ratings indicate sustained limits beyond which damage to the device may occur. All voltage parameters are absolute voltages referenced to COM. The thermal resistance and power dissipation ratings are measured under board mounted and still air conditions. Additional information is shown in figures 7 through 10.

Symbol	Definition	Min.	Max.	Units	
V _B	High side floating supply voltage	-0.3	625	V	
V _S	High side floating supply offset voltage	V _B - 25	V _B + 0.3		
V _{HO}	High side floating output voltage	V _S - 0.3	V _B + 0.3		
V _{CC}	Low side and logic fixed supply voltage	-0.3	25		
V _{LO}	Low side output voltage	-0.3	V _{CC} + 0.3		
V _{IN}	Logic input voltage	-0.3	V _{CC} + 0.3		
dV _S /dt	Allowable offset supply voltage transient (figure 2)	—	50	V/ns	
P _D	Package power dissipation @ T _A ≤ +25°C	(8 Lead PDIP)	—	1.0	W
		(8 lead SOIC)	—	0.625	
R _{thJA}	Thermal resistance, junction to ambient	(8 lead PDIP)	—	125	°C/W
		(8 lead SOIC)	—	200	
T _J	Junction temperature	—	150	°C	
T _S	Storage temperature	-55	150		
T _L	Lead temperature (soldering, 10 seconds)	—	300		

Recommended Operating Conditions

The input/output logic timing diagram is shown in figure 1. For proper operation the device should be used within the recommended conditions. The V_S offset rating is tested with all supplies biased at 15V differential.

Symbol	Definition	Min.	Max.	Units
V _B	High side floating supply absolute voltage	V _S + 10	V _S + 20	V
V _S	High side floating supply offset voltage	Note 1	600	
V _{HO}	High side floating output voltage	V _S	V _B	
V _{CC}	Low side and logic fixed supply voltage	10	20	
V _{LO}	Low side output voltage	0	V _{CC}	
V _{IN}	Logic input voltage	0	V _{CC}	
T _A	Ambient temperature	-40	125	°C

Note 1: Logic operational for V_S of -5 to +600V. Logic state held for V_S of -5V to -V_{BS}. (Please refer to the Design Tip DT97-3 for more details).

Dynamic Electrical Characteristics

V_{BIAS} (V_{CC} , V_{BS}) = 15V, C_L = 1000 pF and T_A = 25°C unless otherwise specified. The dynamic electrical characteristics are measured using the test circuit shown in figure 3.

Symbol	Definition	Min.	Typ.	Max.	Units	Test Conditions
t_{on}	Turn-on propagation delay	550	750	950	ns	$V_S = 0V$
t_{off}	Turn-off propagation delay	—	150	180		$V_S = 600V$
t_r	Turn-on rise time	—	80	130		
t_f	Turn-off fall time	—	40	65		
DT	Deadtime, LS turn-off to HS turn-on & HS turn-off to LS turn-on	480	650	820		
MT	Delay matching, HS & LS turn-on/off	—	30	—		

Static Electrical Characteristics

V_{BIAS} (V_{CC} , V_{BS}) = 15V and T_A = 25°C unless otherwise specified. The V_{IN} , V_{TH} and I_{IN} parameters are referenced to COM. The V_O and I_O parameters are referenced to COM and are applicable to the respective output leads: HO or LO.

Symbol	Definition	Min.	Typ.	Max.	Units	Test Conditions
V_{IH}	Logic "1" input voltage for HO & logic "0" for LO	6.4	—	—	V	$V_{CC} = 10V$
		9.5	—	—		$V_{CC} = 15V$
		12.6	—	—		$V_{CC} = 20V$
V_{IL}	Logic "0" input voltage for HO & logic "1" for LO	—	—	3.8		$V_{CC} = 10V$
		—	—	6.0		$V_{CC} = 15V$
		—	—	8.3		$V_{CC} = 20V$
V_{OH}	High level output voltage, $V_{BIAS} - V_O$	—	—	100	mV	$I_O = 0A$
V_{OL}	Low level output voltage, V_O	—	—	100		$I_O = 0A$
I_{LK}	Offset supply leakage current	—	—	50	μA	$V_B = V_S = 600V$
I_{QBS}	Quiescent V_{BS} supply current	—	50	100		$V_{IN} = 0V$ or V_{CC}
I_{QCC}	Quiescent V_{CC} supply current	—	70	180		$V_{IN} = 0V$ or V_{CC}
I_{IN+}	Logic "1" input bias current	—	30	50		$V_{IN} = V_{CC}$
I_{IN-}	Logic "0" input bias current	—	—	1.0		$V_{IN} = 0V$
V_{BSUV+}	V_{BS} supply undervoltage positive going threshold	7.6	8.6	9.6	V	
V_{BSUV-}	V_{BS} supply undervoltage negative going threshold	7.2	8.2	9.2		
V_{CCUV+}	V_{CC} supply undervoltage positive going threshold	7.6	8.6	9.6		
V_{CCUV-}	V_{CC} supply undervoltage negative going threshold	7.2	8.2	9.2		
I_{O+}	Output high short circuit pulsed current	200	250	—	mA	$V_O = 0V$, $V_{IN} = V_{CC}$ $PW \leq 10 \mu s$
I_{O-}	Output low short circuit pulsed current	420	500	—		$V_O = 15V$, $V_{IN} = 0V$ $PW \leq 10 \mu s$

IR2111(S) & (PbF)

Functional Block Diagram

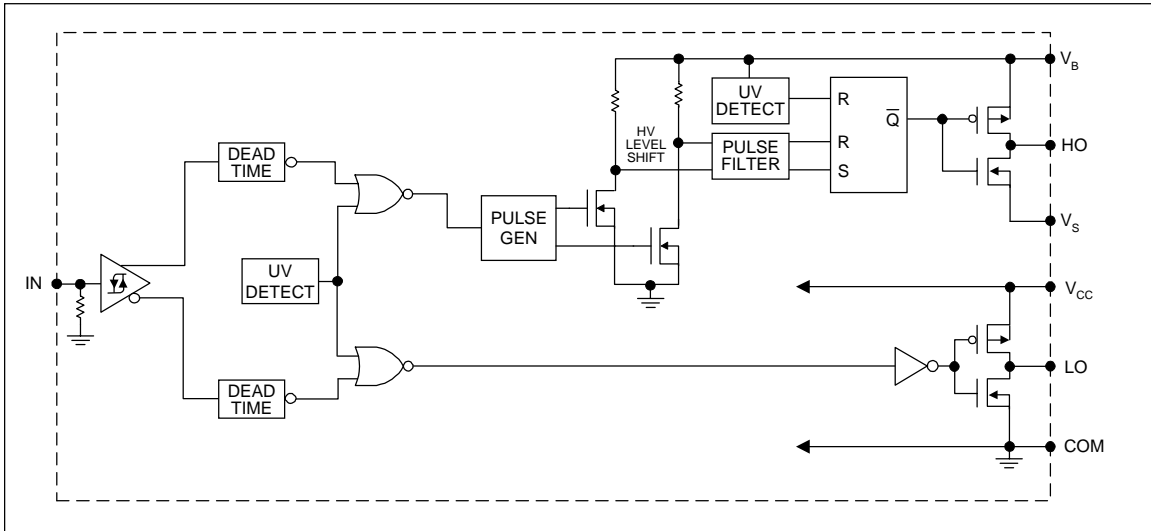

Lead Definitions

Symbol	Description
IN	Logic input for high side and low side gate driver outputs (HO & LO), in phase with HO
V _B	High side floating supply
HO	High side gate drive output
V _S	High side floating supply return
V _{CC}	Low side and logic fixed supply
LO	Low side gate drive output
COM	Low side return

Lead Assignments

<p>8 Lead DIP</p>	<p>8 Lead SOIC</p>
IR2111	IR2111S
Part Number	

IR2111(S) & (PbF)

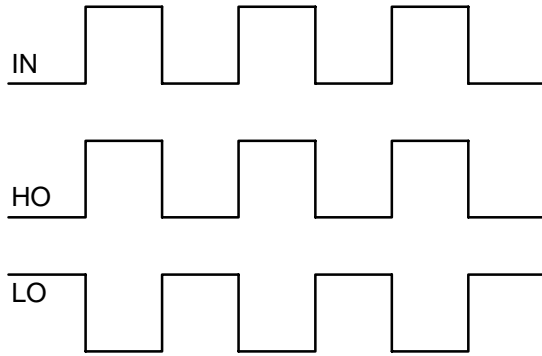

Figure 1. Input/Output Timing Diagram

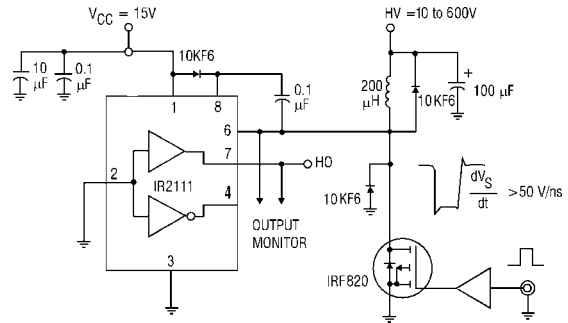

Figure 2. Floating Supply Voltage Transient Test Circuit

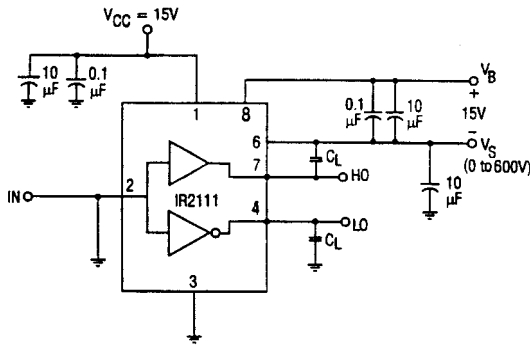

Figure 3. Switching Time Test Circuit

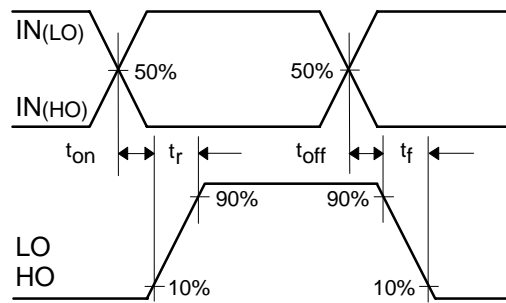

Figure 4. Switching Time Waveform Definition

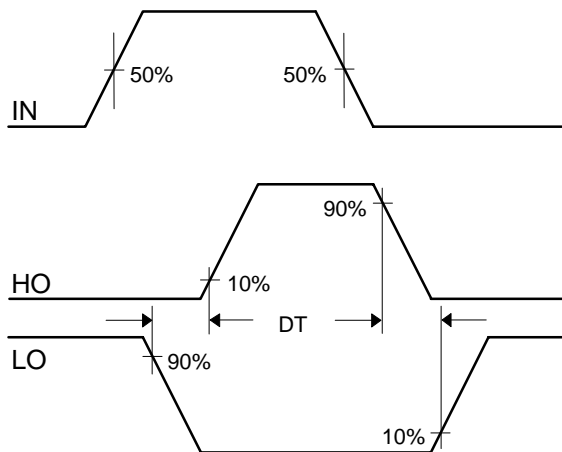

Figure 5. Deadtime Waveform Definitions

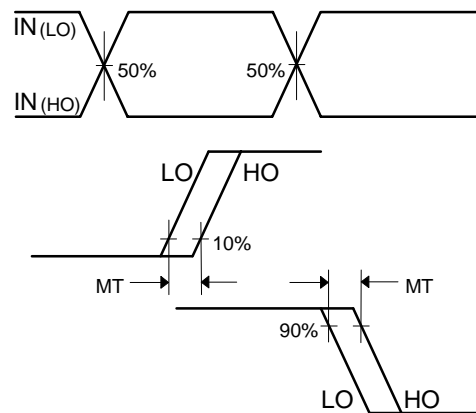

Figure 6. Delay Matching Waveform Definitions

IR2111(S) & (PbF)

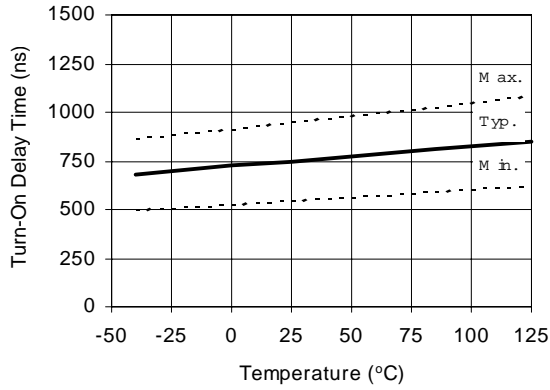

Figure 11A Turn-On Time vs Temperature

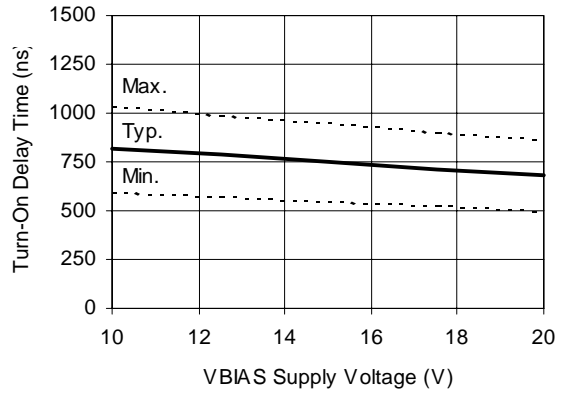

Figure 11B Turn-On Time vs Voltage

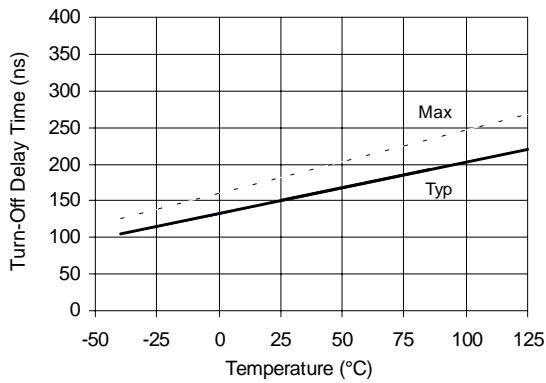

Figure 12A Turn-Off Time vs Temperature

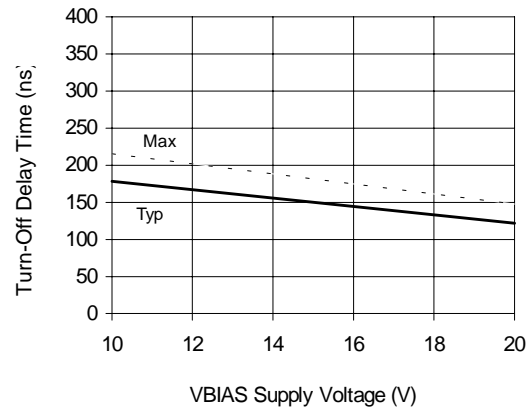

Figure 12B Turn-Off Time vs Voltage

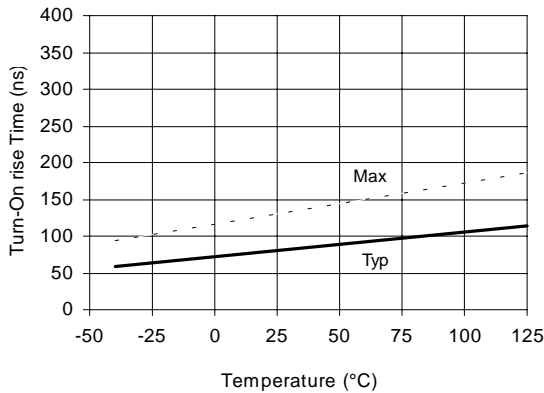

Figure 13A Turn-On Rise Time vs Temperature

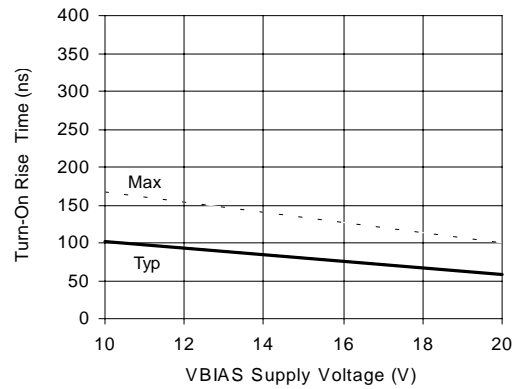

Figure 13B Turn-On Rise Time vs Voltage

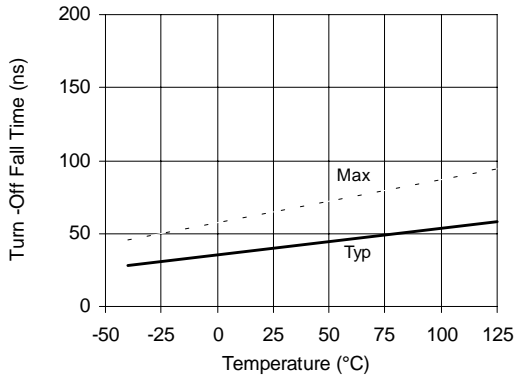

Figure 14A Turn-Off Fall Time vs Temperature

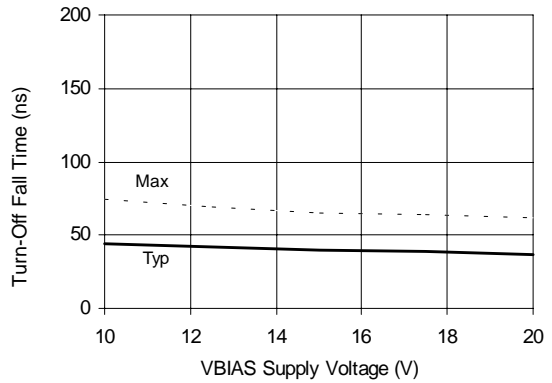

Figure 14B Turn-Off Fall Time vs Voltage

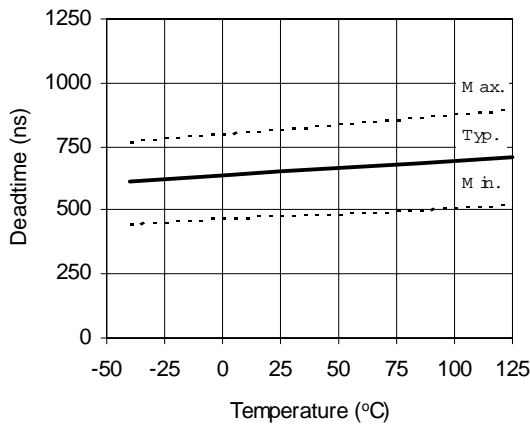

Figure 15A Dead Time vs Temperature

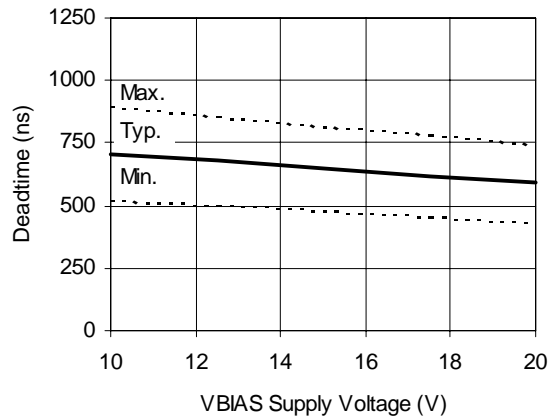

Figure 15B Dead Time vs Voltage

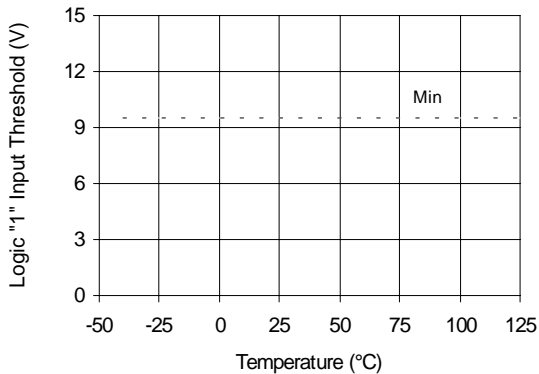

Figure 16A Logic "1" Input voltage for HO & Logic "0" for LO vs Temperature

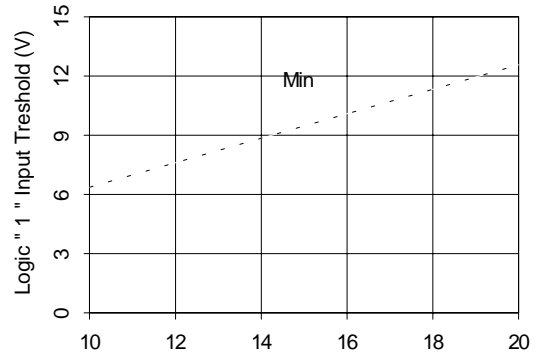

Figure 16B Logic "1" Input voltage for HO & Logic "0" for LO vs Voltage

IR2111(S) & (PbF)

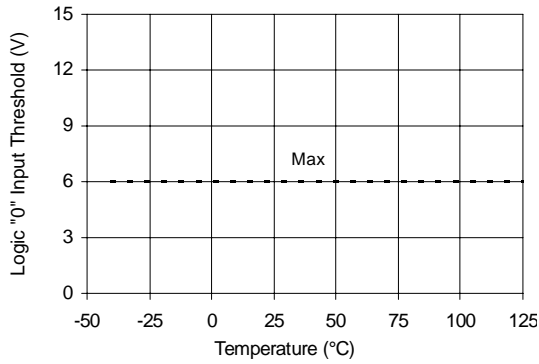

Figure 17A Logic "0" Input voltage for HO & Logic "1" for LO vs Temperature

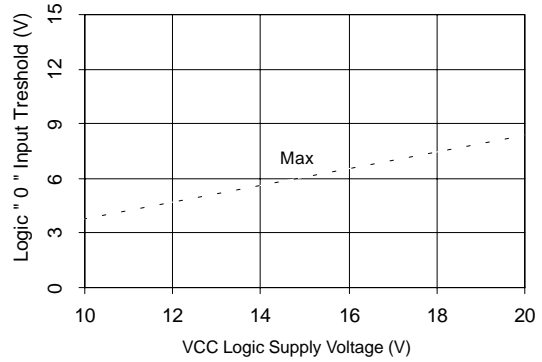

Figure 17B Logic "0" Input voltage for HO & Logic "1" for LO vs Voltage

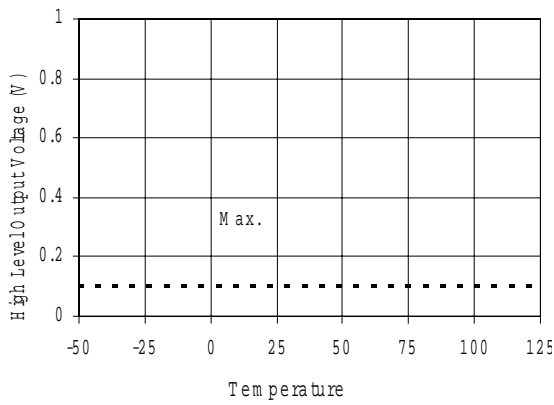

Figure 18A. High Level Output vs. Temperature

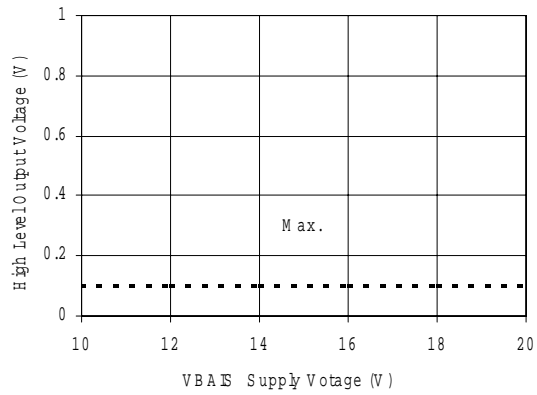

Figure 18B. High Level Output vs. Voltage

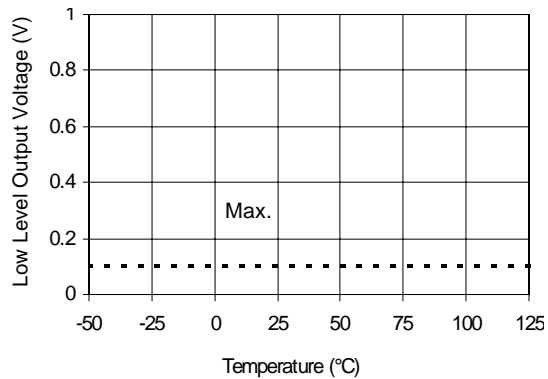

Figure 19A. Low Level Output vs. Temperature

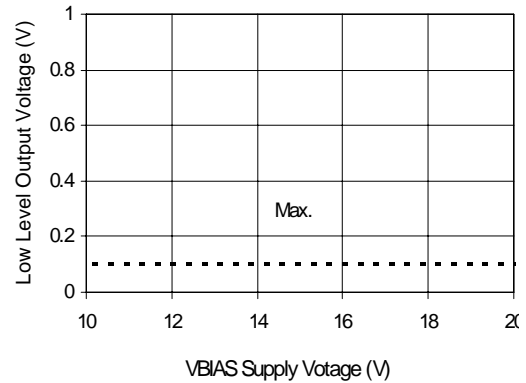

Figure 19B. Low Level Output vs. Voltage

IR2111(S) & (PbF)

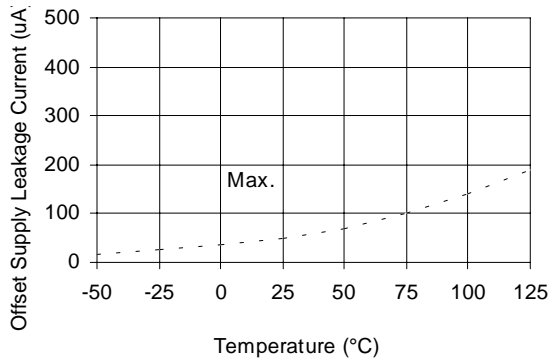

Figure 20A Offset Supply Current vs Temperature

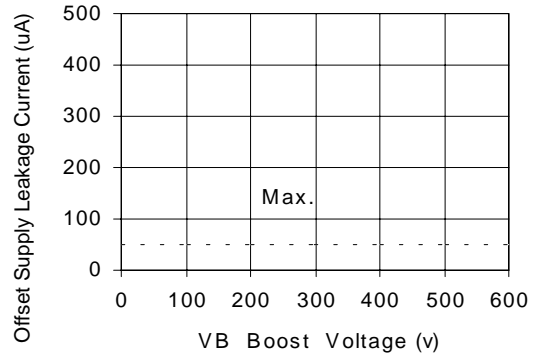

Figure 20B Offset Supply Current vs Voltage

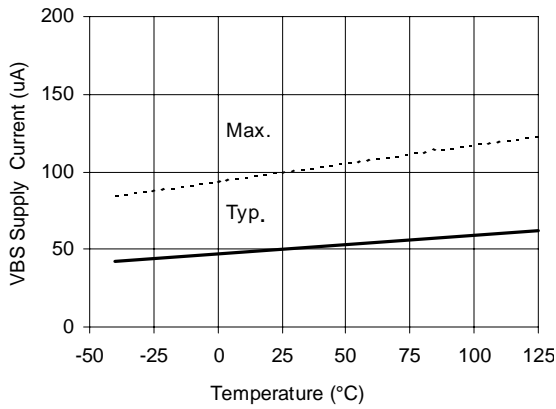

Figure 21A VBS Supply Current vs Temperature

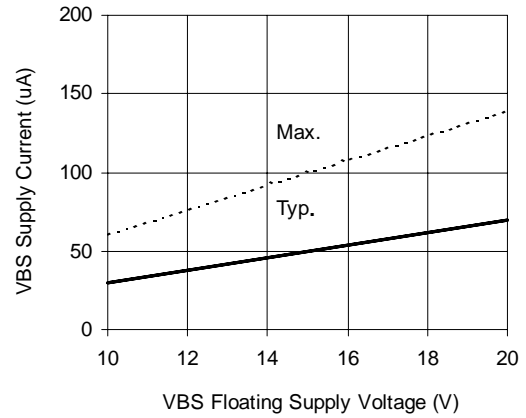

Figure 21B VBS Supply Current vs Voltage

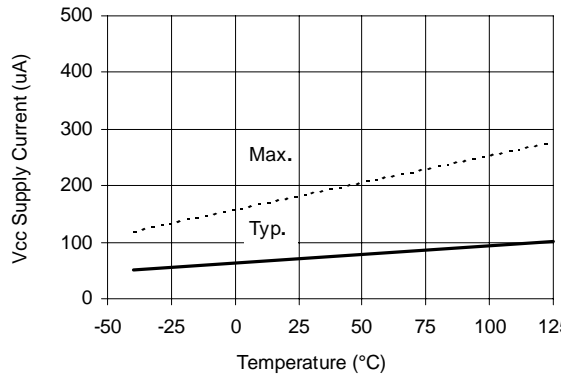

Figure 22A VCC Supply Current vs Temperature

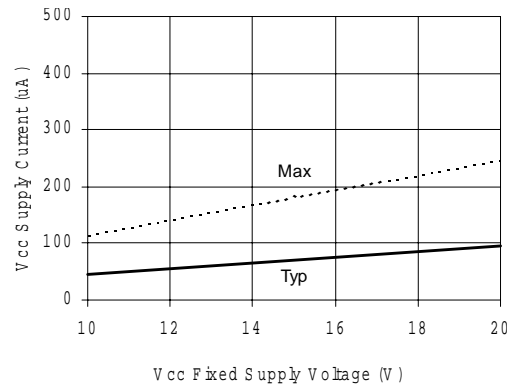

Figure 22B VCC Supply Current vs Voltage

IR2111(S) & (PbF)

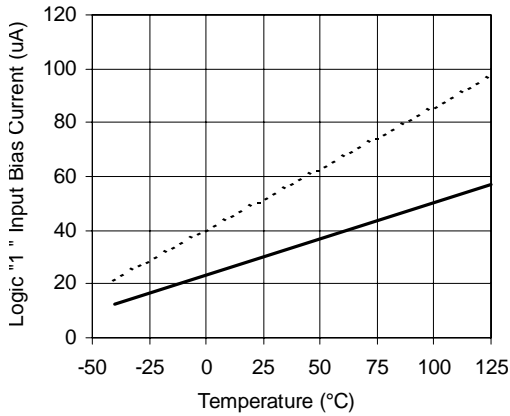

Figure 23A Logic "1" Input Current vs Temperature

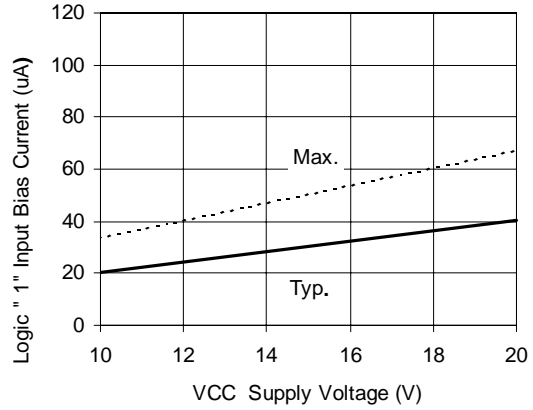

Figure 23B Logic "1" Input Current vs V_{CC} Voltage

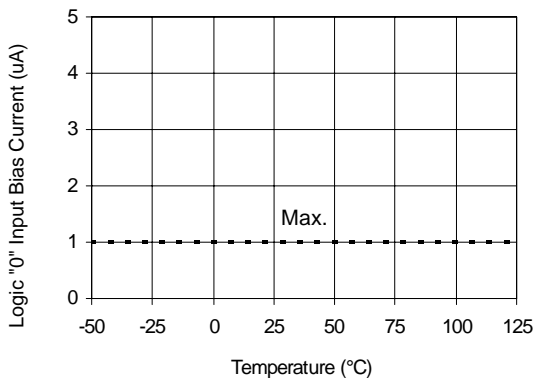

Figure 24A. Logic "0" Input Current vs. Temperature

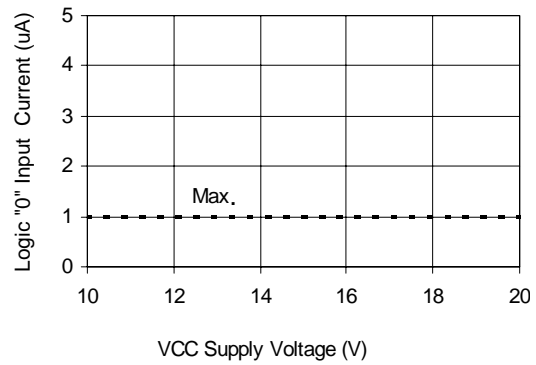

Figure 24B. Logic "0" Input Current vs. V_{CC} Voltage

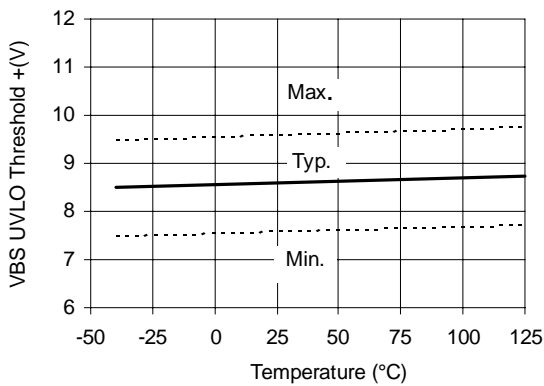

Figure 25 VBS Undervoltage Threshold (+) vs Temperature

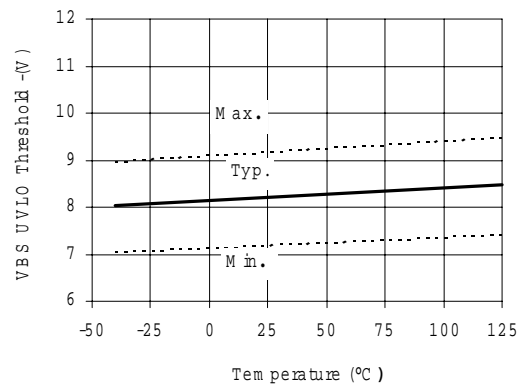

Figure 26 VBS Undervoltage Threshold (-) vs Temperature

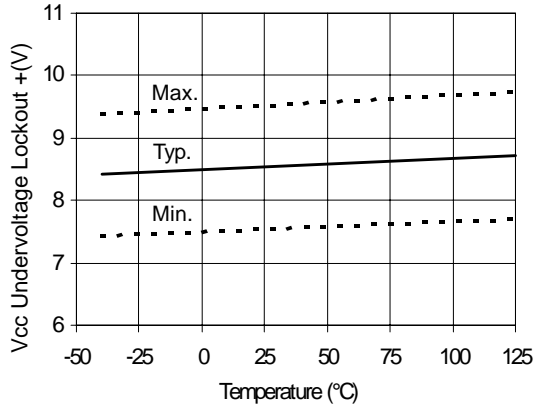

Figure 27 Vcc Undervoltage (-) vs Temperature

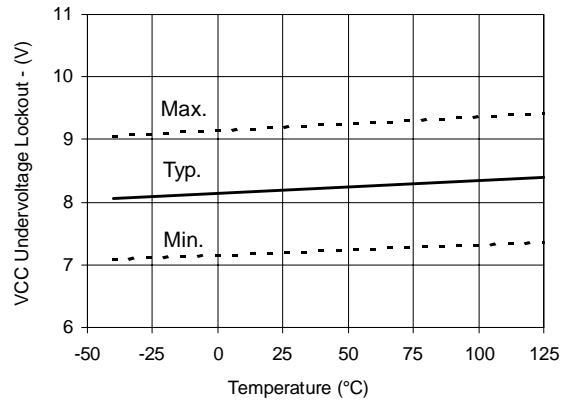

Figure 28 Vcc Undervoltage (-) vs Temperature

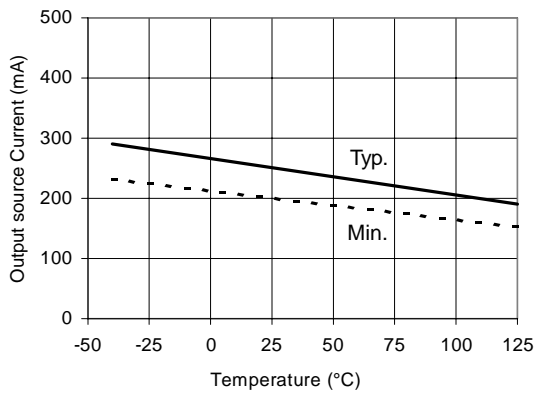

Figure 29A Output Source Current vs Temperature

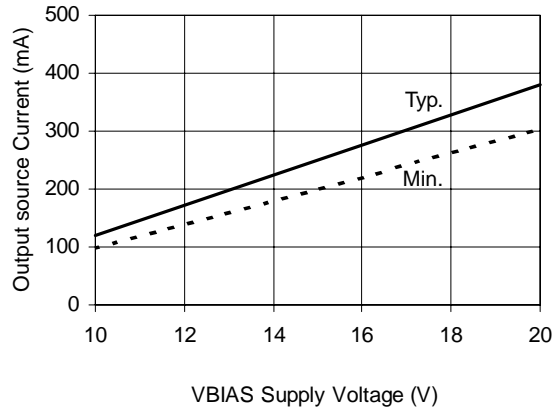

Figure 29B Output Source Current vs Voltage

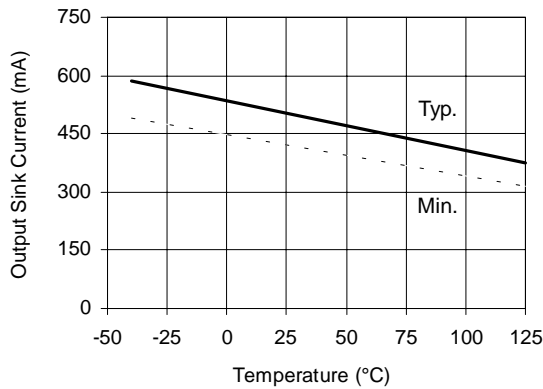

Figure 30A Output Sink Current vs Temperature

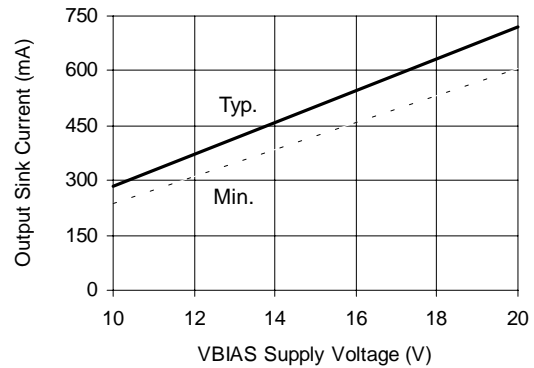

Figure 30B Output Sink Current vs Voltage

IR2111(S)&(PbF)

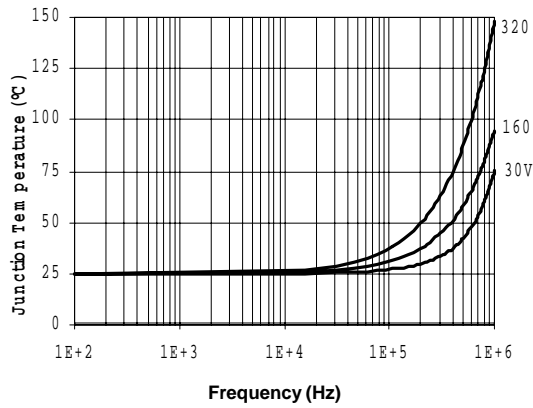

Figure 31. IR2111 T_J vs. Frequency (IRFBC20)
R_{GATE} = 33Ω, V_{CC} = 15V

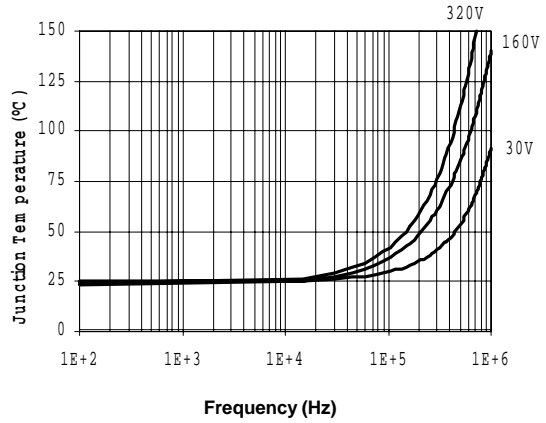

Figure 32. IR2111 T_J vs. Frequency (IRFBC30)
R_{GATE} = 22Ω, V_{CC} = 15V

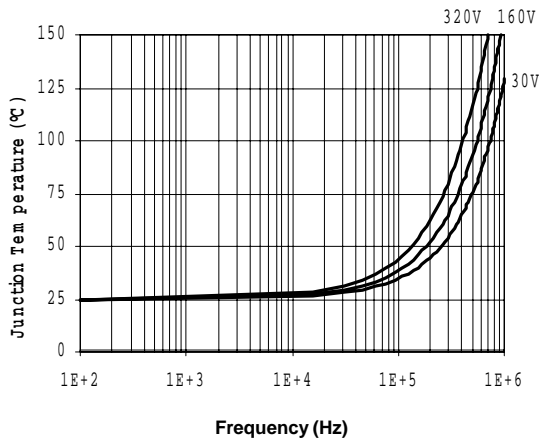

Figure33. IR2111 T_J vs. Frequency (IRFBC40)
R_{GATE} = 15Ω, V_{CC} = 15V

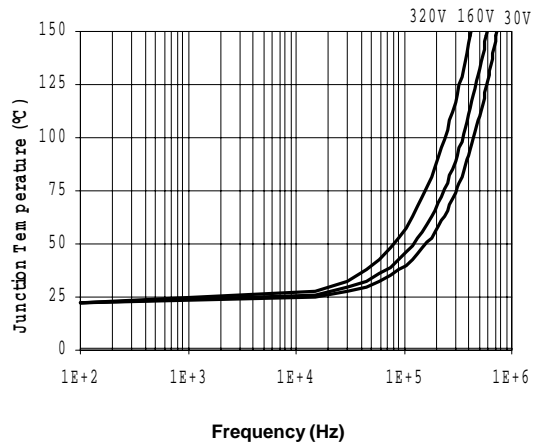

Figure 34. IR2111 T_J vs. Frequency (IRFPC50)
R_{GATE} = 10Ω, V_{CC} = 15V

IR2111(S) & (PbF)

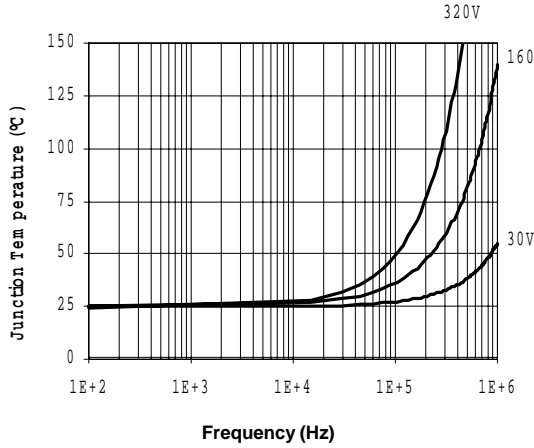

Figure 35. IR2111S T_J vs. Frequency (IRFBC20)
R_{GATE} = 33Ω, V_{CC} = 15V

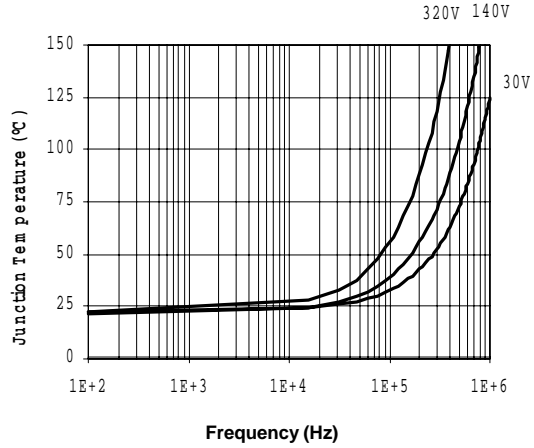

Figure 36. IR2111S T_J vs. Frequency (IRFBC30)
R_{GATE} = 22Ω, V_{CC} = 15V

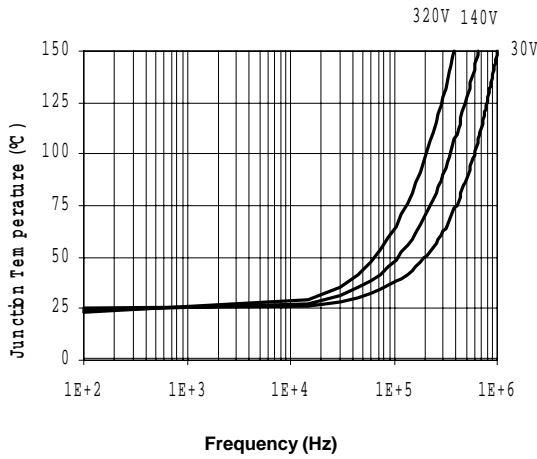

Figure 37. IR2111S T_J vs. Frequency (IRFBC40)
R_{GATE} = 15Ω, V_{CC} = 15V

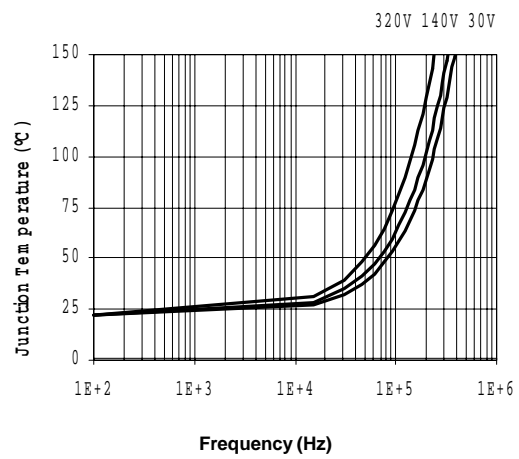
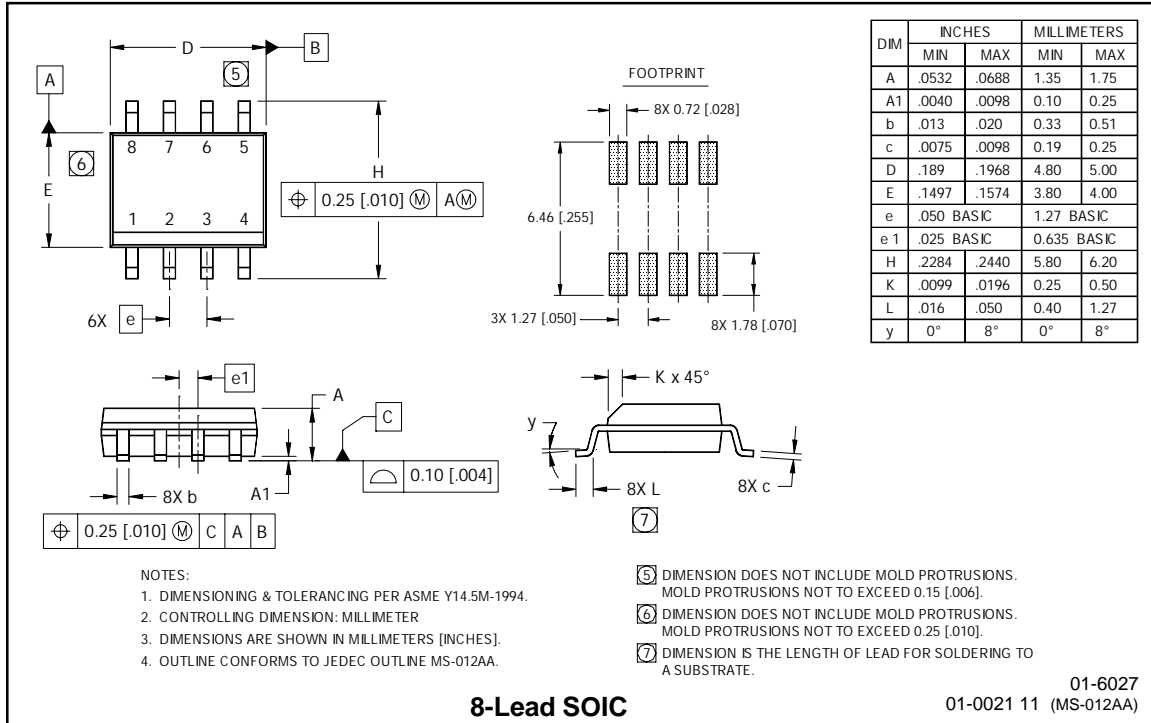
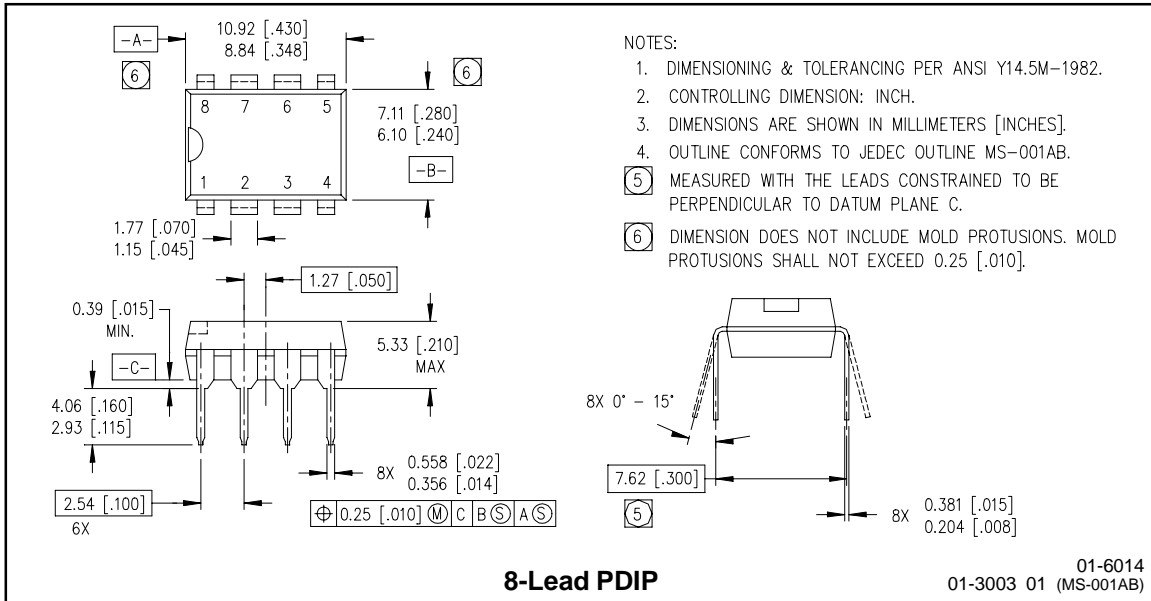

Figure 38. IR2111S T_J vs. Frequency (IRFPC50)
R_{GATE} = 10Ω, V_{CC} = 15V

IR2111(S) & (PbF)

International
IR Rectifier

Case outlines



LEADFREE PART MARKING INFORMATION

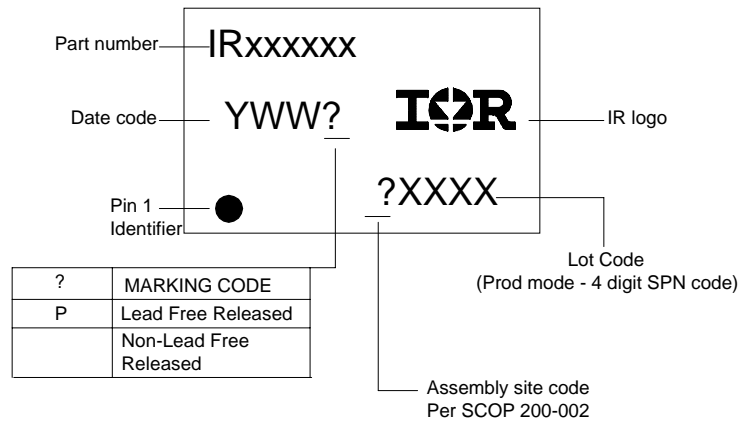

ORDER INFORMATION

Basic Part (Non-Lead Free)

8-Lead PDIP IR2111 order IR2111
 8-Lead SOIC IR2111S order IR2111S

Leadfree Part

8-Lead PDIP IR2111 order IR2111PbF
 8-Lead SOIC IR2111S order IR2111SPbF

Looking for pricing, stock, or lifecycle information?

Click below to explore more details on WIN SOURCE:

 [View IR2111PBF on WIN SOURCE](#)

 [Infineon Technologies](#) Information

Optimize Your Supply Chain with WIN SOURCE Solutions

-  Global Sourcing Solution
-  Obsolete Management
-  Cost Control Management
-  Shortage Management
-  Alternative Solution
-  Excess Inventory Management