



**THE DATASHEET OF  
IR21094STRPBF**



## IR2109(4) (S) & (PbF) HALF-BRIDGE DRIVER

### Features

- Floating channel designed for bootstrap operation Fully operational to +600V Tolerant to negative transient voltage dV/dt immune
- Gate drive supply range from 10 to 20V
- Undervoltage lockout for both channels
- 3.3V, 5V and 15V input logic compatible
- Cross-conduction prevention logic
- Matched propagation delay for both channels
- High side output in phase with IN input
- Logic and power ground +/- 5V offset.
- Internal 540ns dead-time, and programmable up to 5us with one external  $R_{DT}$  resistor (IR21094)
- Lower di/dt gate driver for better noise immunity
- Shut down input turns off both channels.
- Available in Lead-Free

### Description

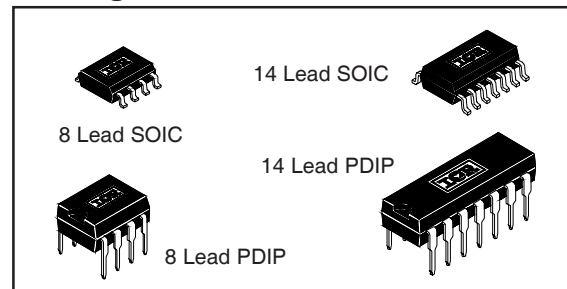
The IR2109(4)(S) are high voltage, high speed power MOSFET and IGBT drivers with dependent high and low side referenced output channels. Proprietary HVIC and latch immune CMOS technologies enable ruggedized monolithic construction. The logic input is compatible with standard CMOS or LSTTL output, down to 3.3V logic. The output drivers feature a high

pulse current buffer stage designed for minimum driver cross-conduction. The floating channel can be used to drive an N-channel power MOSFET or IGBT in the high side configuration which operates up to 600 volts.

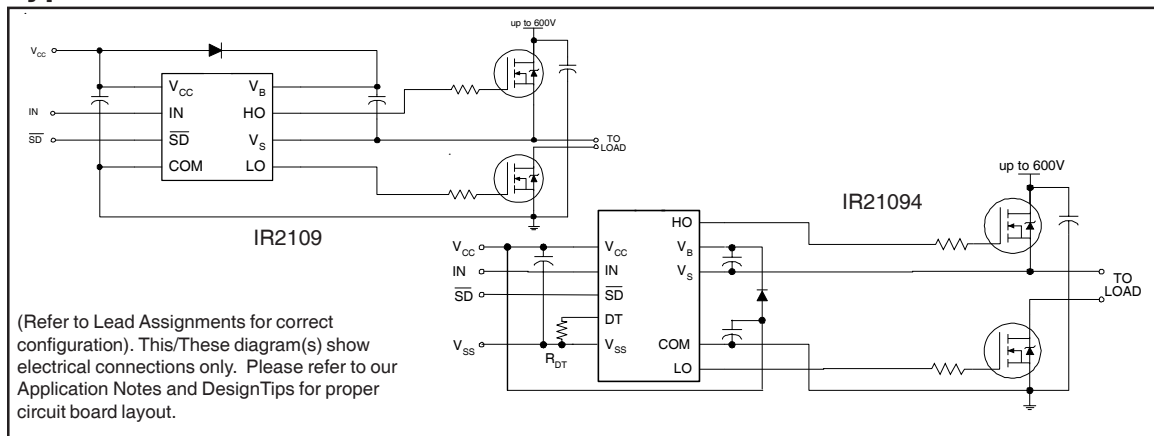
### Product Summary

$V_{OFFSET}$	600V max.
$I_{O+/-}$	120 mA / 250 mA
$V_{OUT}$	10 - 20V
$t_{on/off}$ (typ.)	750 & 200 ns
Dead Time	540 ns
	(programmable up to 5us for IR21094)

### Packages



### Typical Connection



# IR2109(4) (s) & (PbF)

## Absolute Maximum Ratings

Absolute maximum ratings indicate sustained limits beyond which damage to the device may occur. All voltage parameters are absolute voltages referenced to COM. The thermal resistance and power dissipation ratings are measured under board mounted and still air conditions.

Symbol	Definition	Min.	Max.	Units	
V <sub>B</sub>	High side floating absolute voltage	-0.3	625	V	
V <sub>S</sub>	High side floating supply offset voltage	V <sub>B</sub> - 25	V <sub>B</sub> + 0.3		
V <sub>HO</sub>	High side floating output voltage	V <sub>S</sub> - 0.3	V <sub>B</sub> + 0.3		
V <sub>CC</sub>	Low side and logic fixed supply voltage	-0.3	25		
V <sub>LO</sub>	Low side output voltage	-0.3	V <sub>CC</sub> + 0.3		
DT	Programmable dead-time pin voltage (IR21094 only)	V <sub>SS</sub> - 0.3	V <sub>CC</sub> + 0.3		
V <sub>IN</sub>	Logic input voltage (IN & $\overline{SD}$ )	V <sub>SS</sub> - 0.3	V <sub>CC</sub> + 0.3		
V <sub>SS</sub>	Logic ground (IR21094/IR21894 only)	V <sub>CC</sub> - 25	V <sub>CC</sub> + 0.3		
dV <sub>S</sub> /dt	Allowable offset supply voltage transient	—	50	V/ns	
P <sub>D</sub>	Package power dissipation @ T <sub>A</sub> ≤ +25°C	(8 Lead PDIP)	—	1.0	W
		(8 Lead SOIC)	—	0.625	
		(14 lead PDIP)	—	1.6	
		(14 lead SOIC)	—	1.0	
R <sub>thJA</sub>	Thermal resistance, junction to ambient	(8 Lead PDIP)	—	125	°C/W
		(8 Lead SOIC)	—	200	
		(14 lead PDIP)	—	75	
		(14 lead SOIC)	—	120	
T <sub>J</sub>	Junction temperature	—	150	°C	
T <sub>S</sub>	Storage temperature	-50	150		
T <sub>L</sub>	Lead temperature (soldering, 10 seconds)	—	300		

## Recommended Operating Conditions

The input/output logic timing diagram is shown in figure 1. For proper operation the device should be used within the recommended conditions. The  $V_S$  and  $V_{SS}$  offset rating are tested with all supplies biased at 15V differential.

Symbol	Definition	Min.	Max.	Units
$V_B$	High side floating supply absolute voltage	$V_S + 10$	$V_S + 20$	V
$V_S$	High side floating supply offset voltage	Note 1	600	
$V_{HO}$	High side floating output voltage	$V_S$	$V_B$	
$V_{CC}$	Low side and logic fixed supply voltage	10	20	
$V_{LO}$	Low side output voltage	0	$V_{CC}$	
$V_{IN}$	Logic input voltage (IN & $\overline{SD}$ )	$V_{SS}$	$V_{CC}$	
DT	Programmable dead-time pin voltage (IR21094 only)	$V_{SS}$	$V_{CC}$	
$V_{SS}$	Logic ground (IR21094 only)	-5	5	°C
$T_A$	Ambient temperature	-40	125	

Note 1: Logic operational for  $V_S$  of -5V to +600V. Logic state held for  $V_S$  of -5V to  $-V_{BS}$ . (Please refer to the Design Tip DT97-3 for more details).

## Dynamic Electrical Characteristics

$V_{BIAS}$  ( $V_{CC}$ ,  $V_{BS}$ ) = 15V,  $V_{SS}$  = COM,  $C_L$  = 1000 pF,  $T_A$  = 25°C, DT =  $V_{SS}$  unless otherwise specified.

Symbol	Definition	Min.	Typ.	Max.	Units	Test Conditions
$t_{on}$	Turn-on propagation delay	—	750	950	nsec	$V_S = 0V$
$t_{off}$	Turn-off propagation delay	—	200	280		$V_S = 0V$ or 600V
$t_{sd}$	Shut-down propagation delay	—	200	280		
MT	Delay matching, HS & LS turn-on/off	—	0	70		
$t_r$	Turn-on rise time	—	150	220		$V_S = 0V$
$t_f$	Turn-off fall time	—	50	80		$V_S = 0V$
DT	Deadtime: LO turn-off to HO turn-on (DTLO-HO) & HO turn-off to LO turn-on (DTHO-LO)	400	540	680	usec	RDT = 0
		4	5	6		RDT = 200k (IR21094)
MDT	Deadtime matching = DTLO - HO - DTHO-LO	—	0	60	nsec	RDT=0
		—	0	600		RDT = 200k (IR21094)

# IR2109(4) (s) & (PbF)

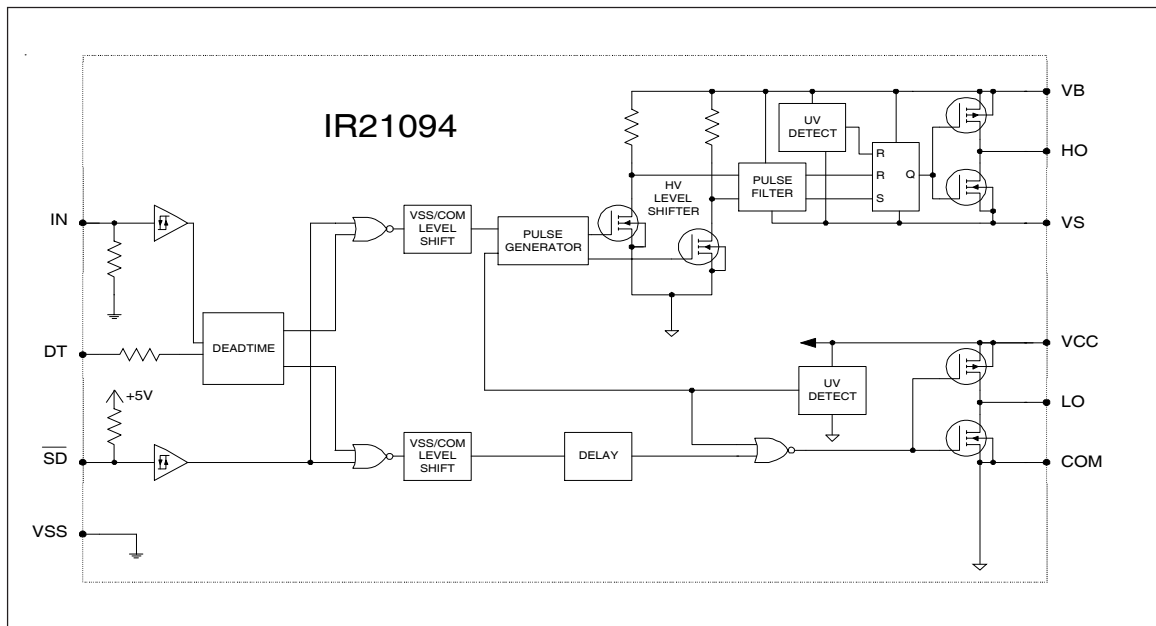
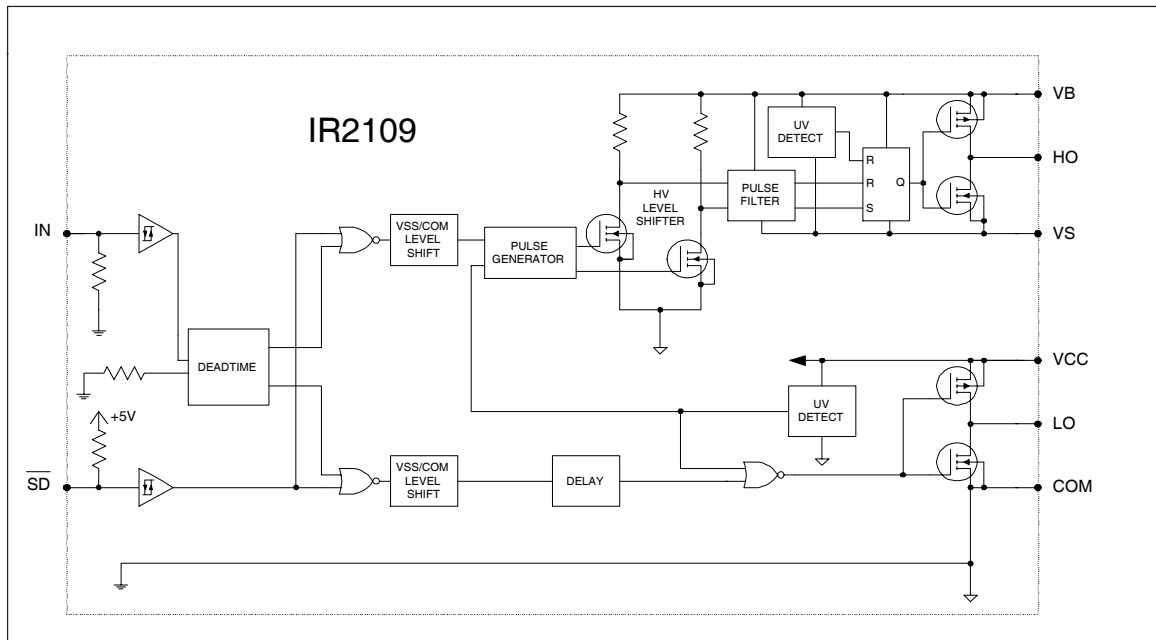
International  
IR Rectifier

## Static Electrical Characteristics

$V_{BIAS}$  ( $V_{CC}$ ,  $V_{BS}$ ) = 15V,  $V_{SS}$  = COM,  $DT = V_{SS}$  and  $T_A = 25^\circ\text{C}$  unless otherwise specified. The  $V_{IL}$ ,  $V_{IH}$  and  $I_{IN}$  parameters are referenced to  $V_{SS}/\text{COM}$  and are applicable to the respective input leads: IN and SD. The  $V_O$ ,  $I_O$  and  $R_{on}$  parameters are referenced to COM and are applicable to the respective output leads: HO and LO.

Symbol	Definition	Min.	Typ.	Max.	Units	Test Conditions
$V_{IH}$	Logic "1" input voltage for HO & logic "0" for LO	2.9	—	—	V	$V_{CC} = 10\text{V to }20\text{V}$
$V_{IL}$	Logic "0" input voltage for HO & logic "1" for LO	—	—	0.8		$V_{CC} = 10\text{V to }20\text{V}$
$V_{SD,TH+}$	$\overline{SD}$ input positive going threshold	2.9	—	—		$V_{CC} = 10\text{V to }20\text{V}$
$V_{SD,TH-}$	$\overline{SD}$ input negative going threshold	—	—	0.8		$V_{CC} = 10\text{V to }20\text{V}$
$V_{OH}$	High level output voltage, $V_{BIAS} - V_O$	—	0.8	1.4		$I_O = 20\text{ mA}$
$V_{OL}$	Low level output voltage, $V_O$	—	0.3	0.6		$I_O = 20\text{ mA}$
$I_{LK}$	Offset supply leakage current	—	—	50	$\mu\text{A}$	$V_B = V_S = 600\text{V}$
$I_{QBS}$	Quiescent $V_{BS}$ supply current	20	75	130		$V_{IN} = 0\text{V or }5\text{V}$
$I_{QCC}$	Quiescent $V_{CC}$ supply current	0.4	1.0	1.6	mA	$V_{IN} = 0\text{V or }5\text{V}$ $RDT = 0$
$I_{IN+}$	Logic "1" input bias current	—	5	20	$\mu\text{A}$	$IN = 5\text{V}, \overline{SD} = 0\text{V}$
$I_{IN-}$	Logic "0" input bias current	—	—	2		$IN = 0\text{V}, \overline{SD} = 5\text{V}$
$V_{CCUV+}$ $V_{BSUV+}$	$V_{CC}$ and $V_{BS}$ supply undervoltage positive going threshold	8.0	8.9	9.8	V	
$V_{CCUV-}$ $V_{BSUV-}$	$V_{CC}$ and $V_{BS}$ supply undervoltage negative going threshold	7.4	8.2	9.0		
$V_{CCUVH}$ $V_{BSUVH}$	Hysteresis	0.3	0.7	—		
$I_{O+}$	Output high short circuit pulsed current	120	200	—	mA	$V_O = 0\text{V}, PW \leq 10\ \mu\text{s}$
$I_{O-}$	Output low short circuit pulsed current	250	350	—		$V_O = 15\text{V}, PW \leq 10\ \mu\text{s}$

## Functional Block Diagrams

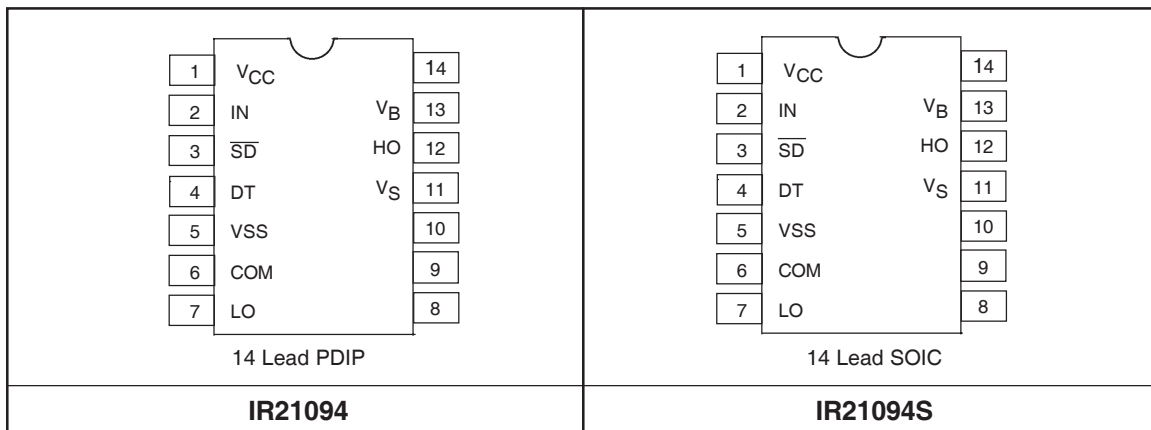
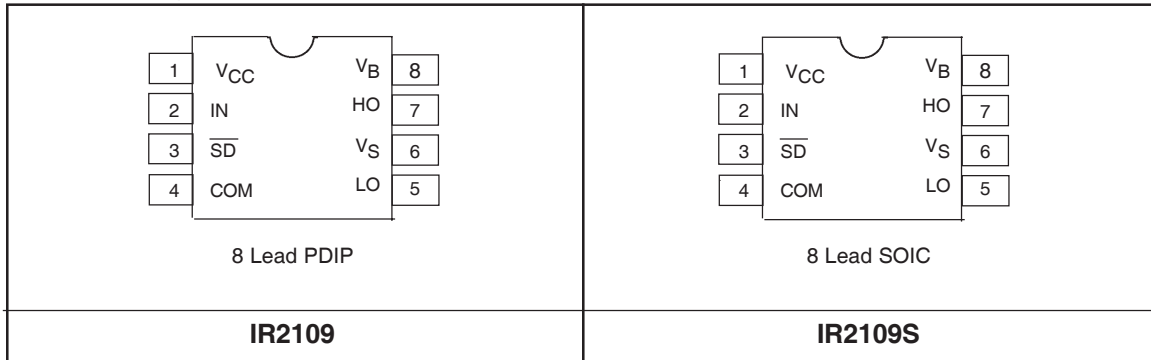


# IR2109(4) (s) & (PbF)

## Lead Definitions

Symbol	Description
IN	Logic input for high and low side gate driver outputs (HO and LO), in phase with HO (referenced to COM for IR2109 and VSS for IR21094)
$\overline{SD}$	Logic input for shutdown (referenced to COM for IR2109 and VSS for IR21094)
DT	Programmable dead-time lead, referenced to VSS. (IR21094 only)
VSS	Logic Ground (21094 only)
$V_B$	High side floating supply
HO	High side gate drive output
$V_S$	High side floating supply return
$V_{CC}$	Low side and logic fixed supply
LO	Low side gate drive output
COM	Low side return

## Lead Assignments



# IR2109(4) (S) & (PbF)

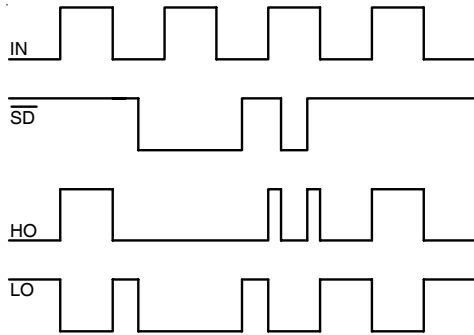


Figure 1. Input/Output Timing Diagram

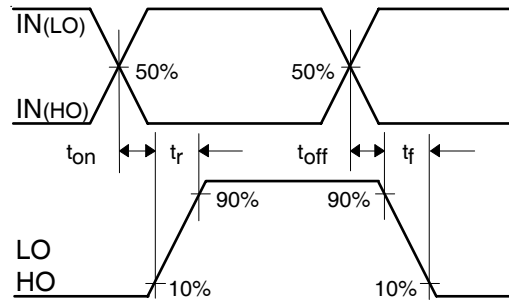


Figure 2. Switching Time Waveform Definitions

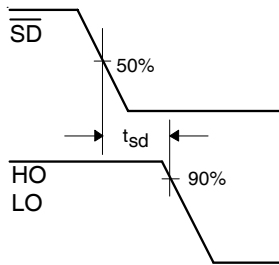


Figure 3. Shutdown Waveform Definitions

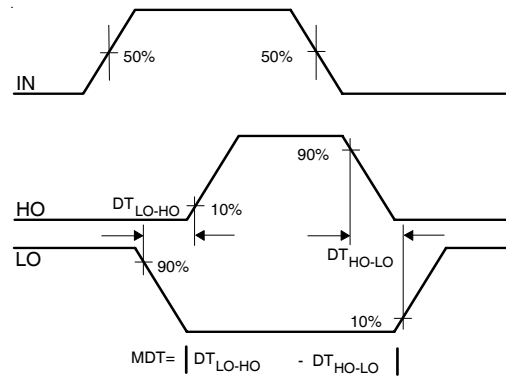


Figure 4. Deadtime Waveform Definitions

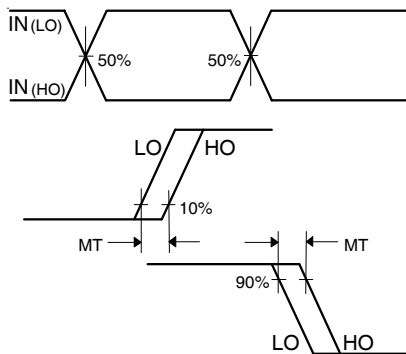


Figure 5. Delay Matching Waveform Definitions

# IR2109(4) (s) & (PbF)

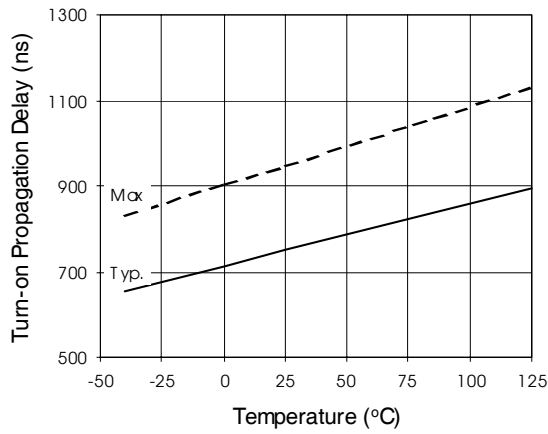


Figure 6A. Turn-on Propagation Delay vs. Temperature

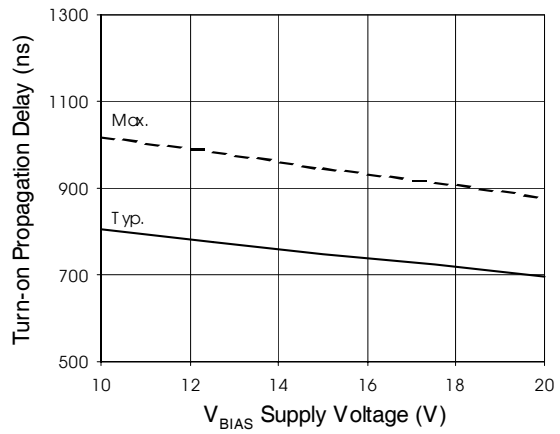


Figure 6B. Turn-on Propagation Delay vs. Supply Voltage

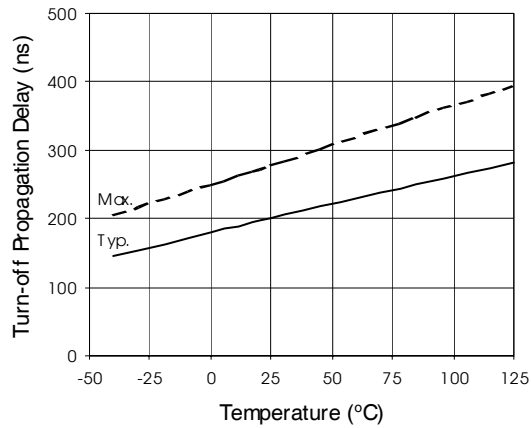


Figure 7A. Turn-off Propagation Delay vs. Temperature

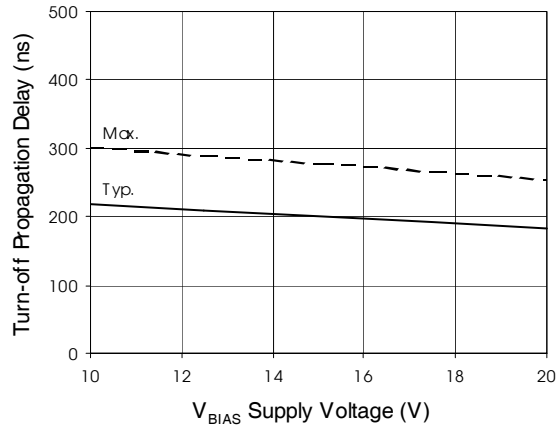
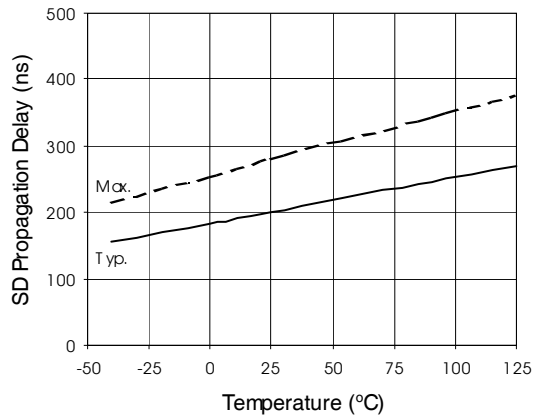
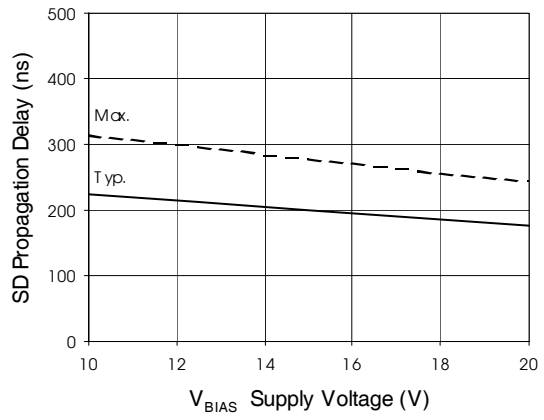


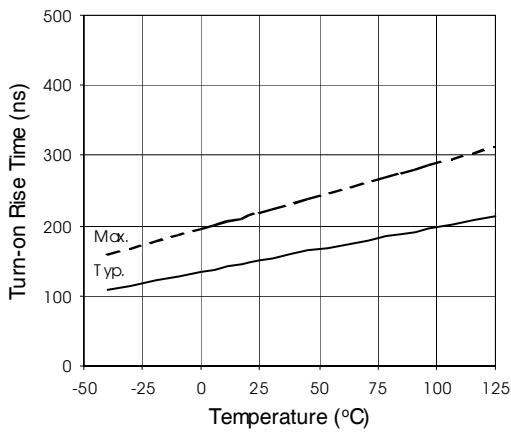
Figure 7B. Turn-off Propagation Delay vs. Supply Voltage



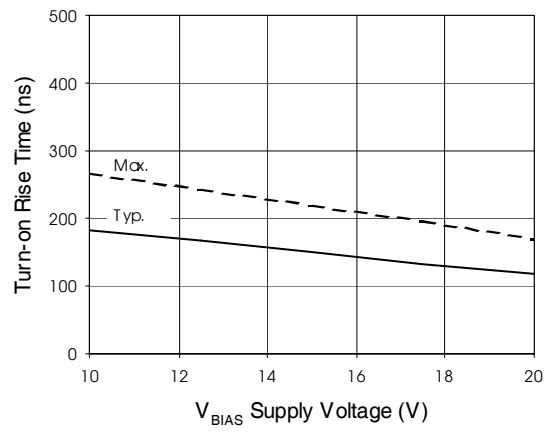
**Figure 8A. SD Propagation Delay vs. Temperature**



**Figure 8B. SD Propagation Delay vs. Supply Voltage**

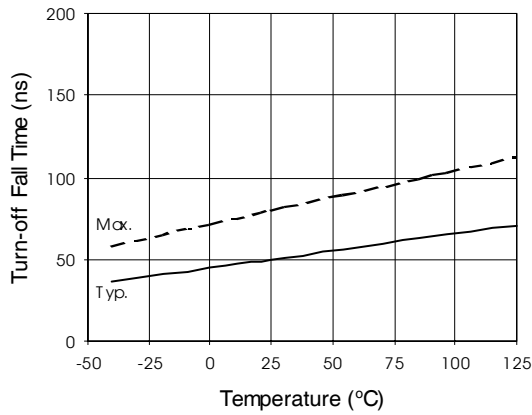


**Figure 9A. Turn-on Rise Time vs. Temperature**

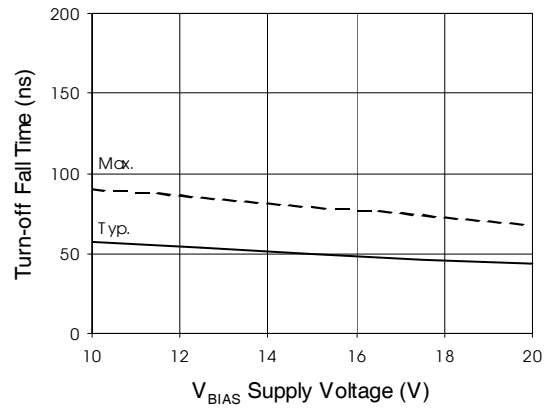


**Figure 9B. Turn-on Rise Time vs. Supply Voltage**

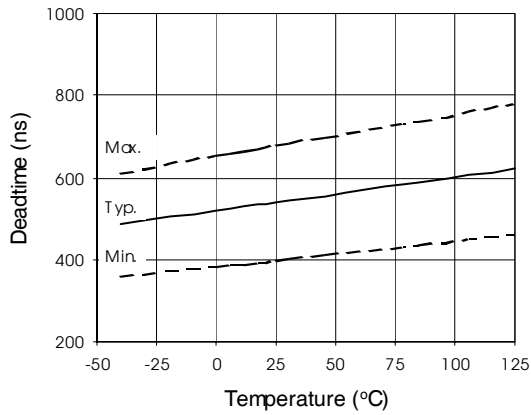
# IR2109(4) (s) & (PbF)



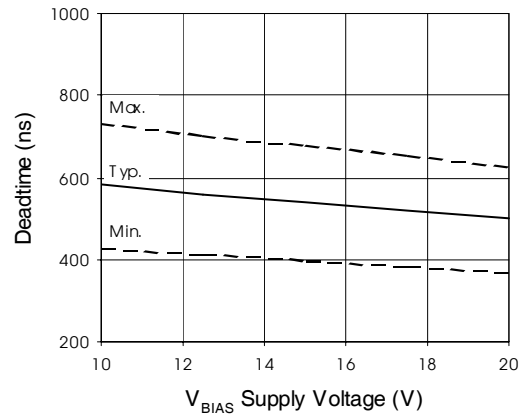
**Figure 10A. Turn-off Fall Time vs. Temperature**



**Figure 10B. Turn-off Fall Time vs. Supply Voltage**

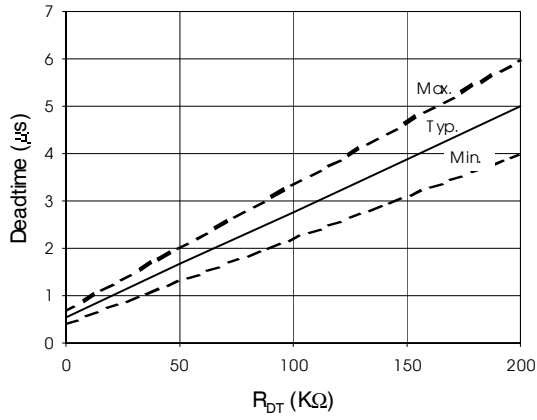


**Figure 11A. Deadtime vs. Temperature**

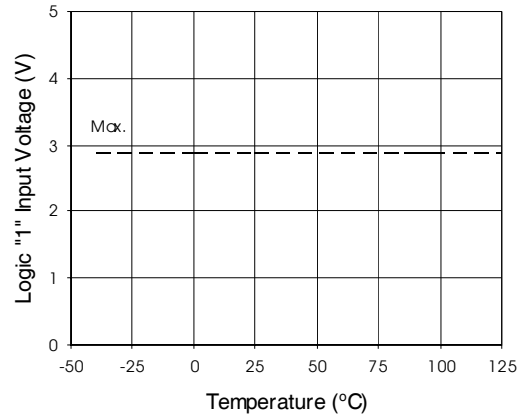


**Figure 11B. Deadtime vs. Supply Voltage**

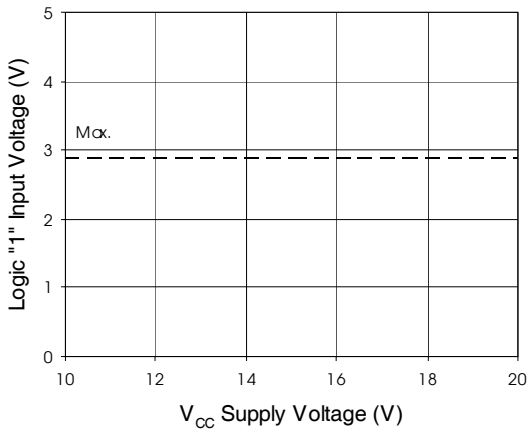
# IR2109(4) (S) & (PbF)



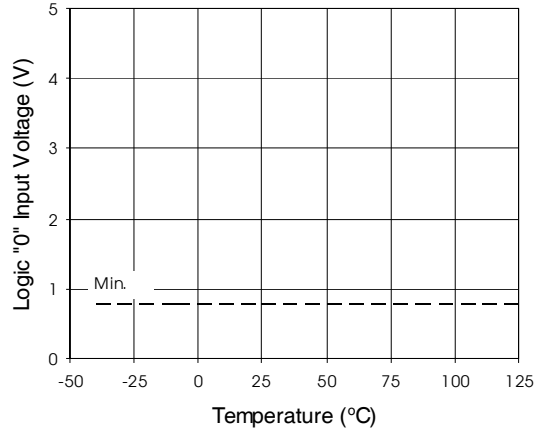
**Figure 11C. Deadtime vs. RDT  
 (IR21094 only)**



**Figure 12A. Logic "1" Input Voltage  
 vs. Temperature**

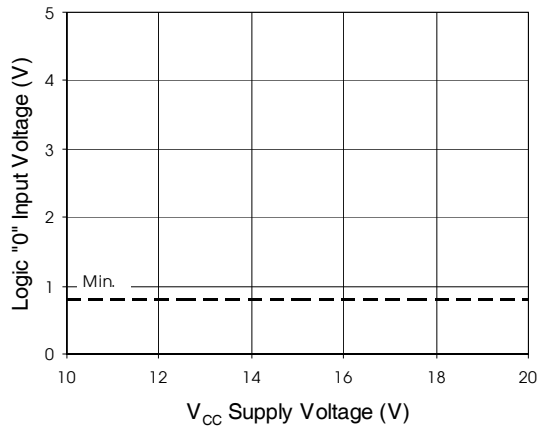


**Figure 12B. Logic "1" Input Voltage  
 vs. Supply Voltage**

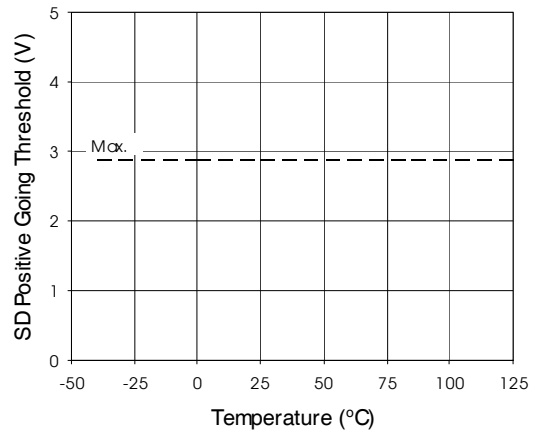


**Figure 13A. Logic "0" Input Voltage  
 vs. Temperature**

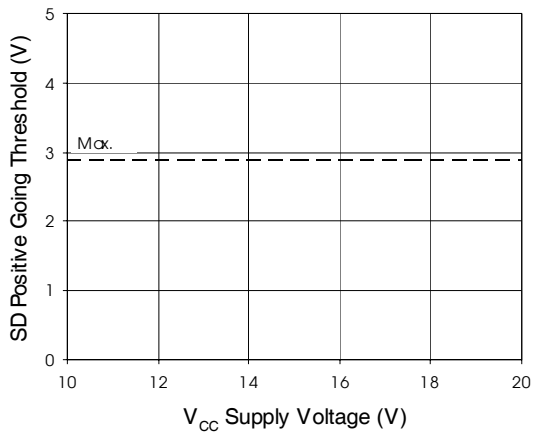
# IR2109(4) (s) & (PbF)



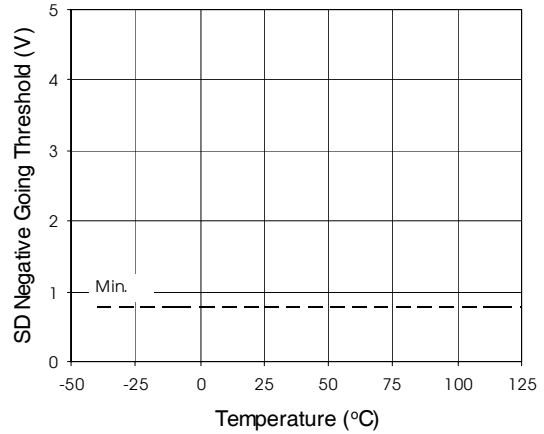
**Figure 13B. Logic "0" Input Current vs. Supply Voltage**



**Figure 14A. SD Positive Going Threshold vs. Temperature**



**Figure 14B. SD Positive Going Threshold vs. Supply Voltage**



**Figure 15A. SD Negative Going Threshold vs. Temperature**

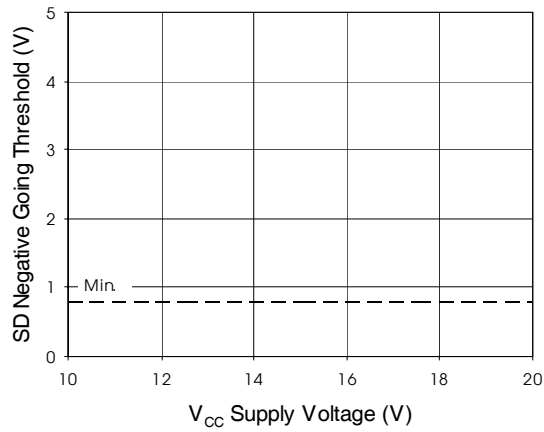


Figure 15B. SD Negative Going Threshold vs. Supply Voltage

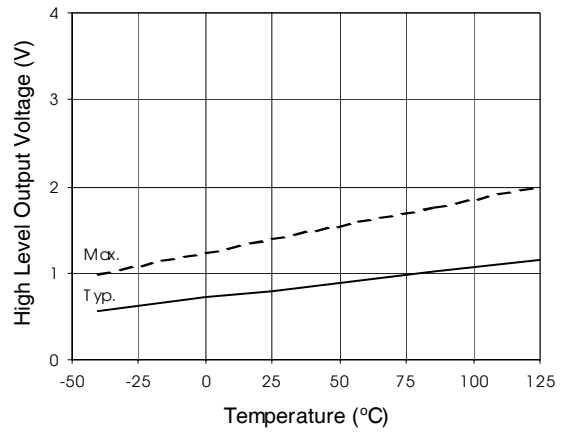


Figure 16A. High Level Output Voltage vs. Temperature

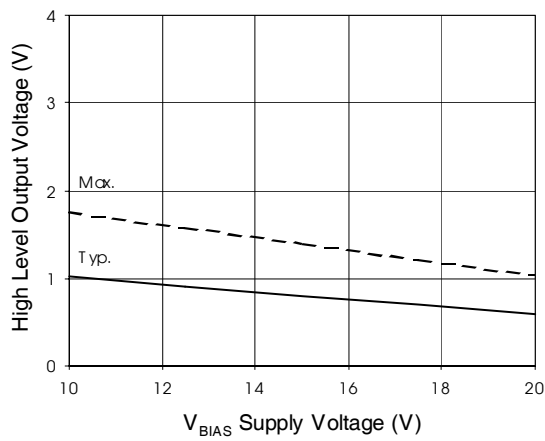


Figure 16B. High Level Output Voltage vs. Supply Voltage

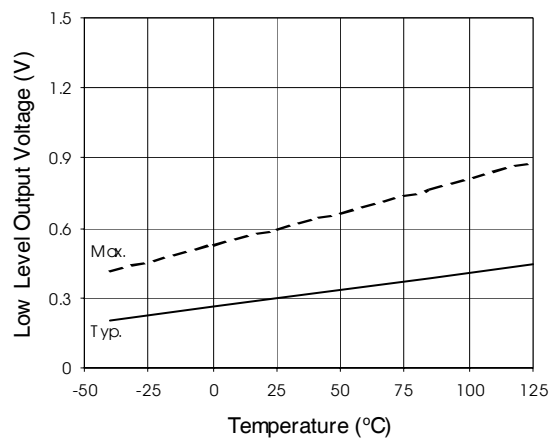


Figure 17A. Low Level Output Voltage vs. Temperature

# IR2109(4) (s) & (PbF)

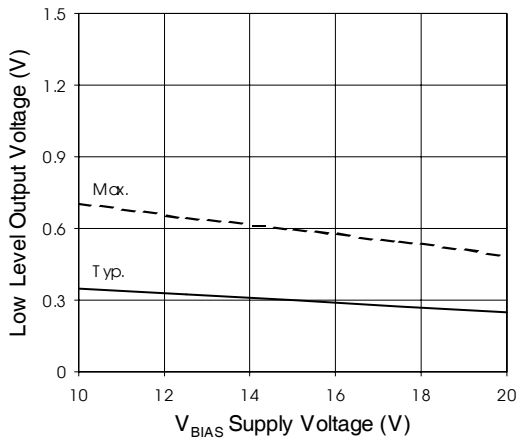


Figure 17B. Low Level Output Voltage vs. Supply Voltage

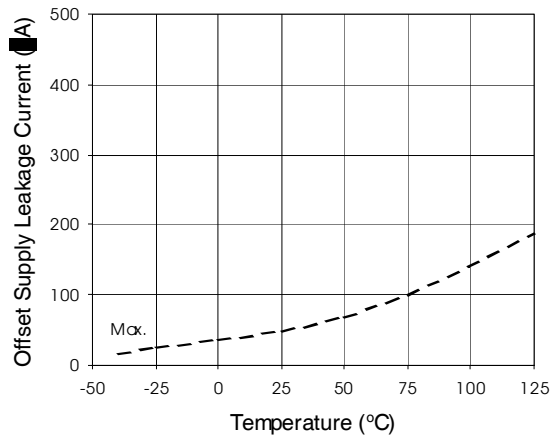


Figure 18A. Offset Supply Leakage Current vs. Temperature

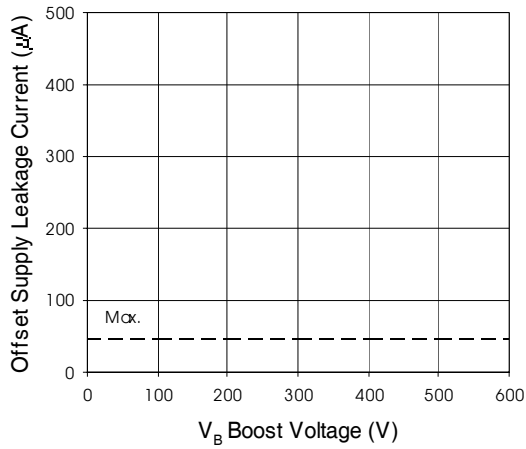


Figure 18B. Offset Supply Leakage Current vs. Boost Voltage

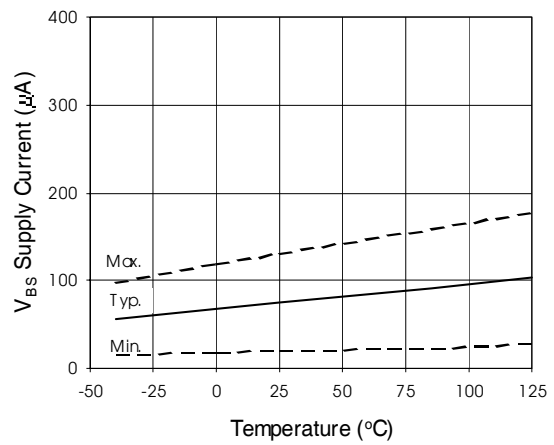
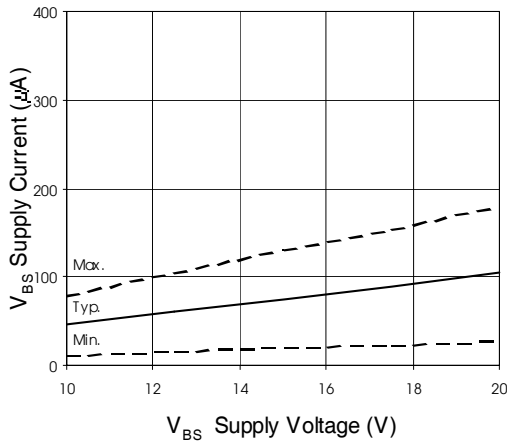
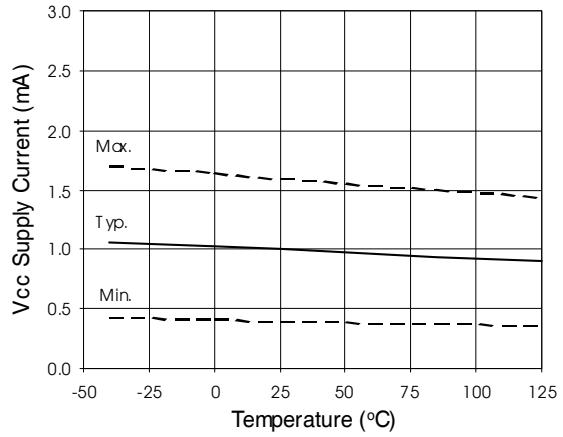


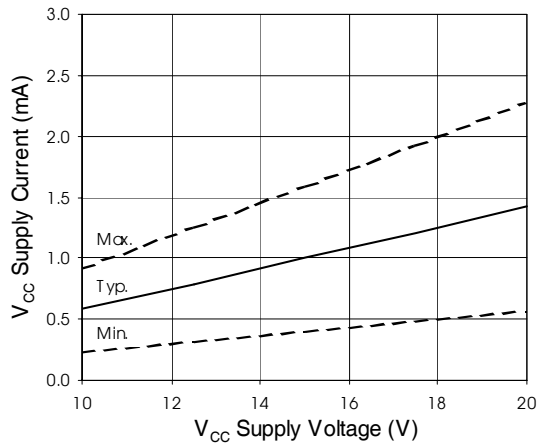
Figure 19A. V<sub>BS</sub> Supply Current vs. Temperature



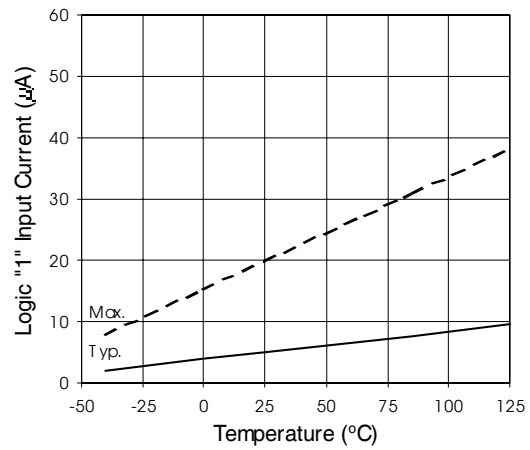
**Figure 19B. V<sub>BS</sub> Supply Current vs. Supply Voltage**



**Figure 20A. V<sub>CC</sub> Supply Current vs. Temperature**



**Figure 20B. V<sub>CC</sub> Supply Current vs. V<sub>CC</sub> Supply Voltage**



**Figure 21A. Logic "1" Input Current vs. Temperature**

# IR2109(4) (s) & (PbF)

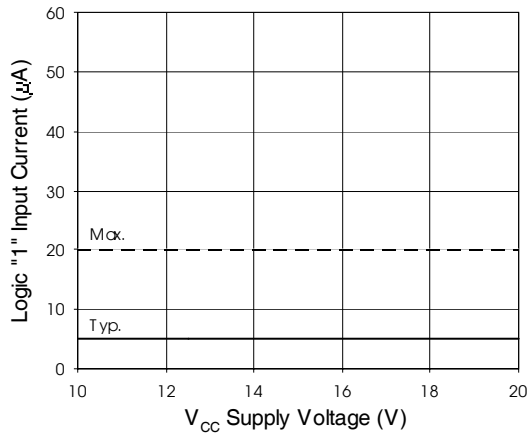


Figure 21B. Logic "1" Input Current vs. Supply Voltage

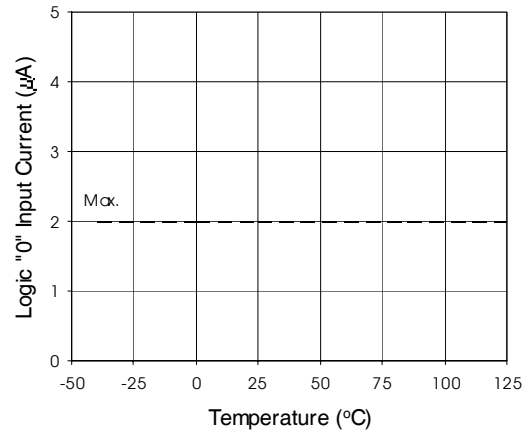


Figure 22A. Logic "0" Input Current vs. Temperature

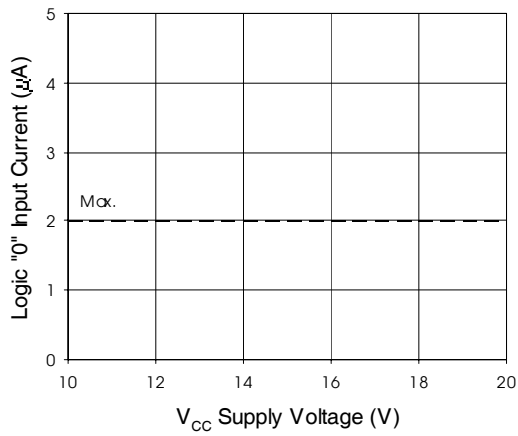


Figure 22B. Logic "0" Input Current vs. Supply Voltage

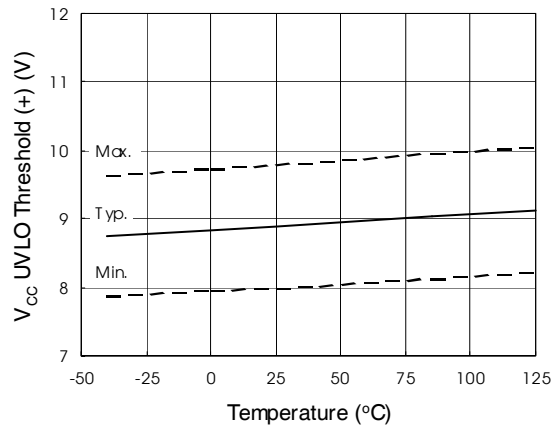


Figure 23. V<sub>CC</sub> Undervoltage Threshold (+) vs. Temperature

# IR2109(4) (S) & (PbF)

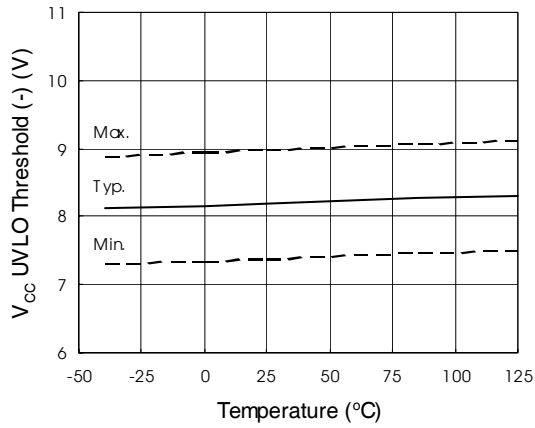


Figure 24.  $V_{CC}$  Undervoltage Threshold (-) vs. Temperature

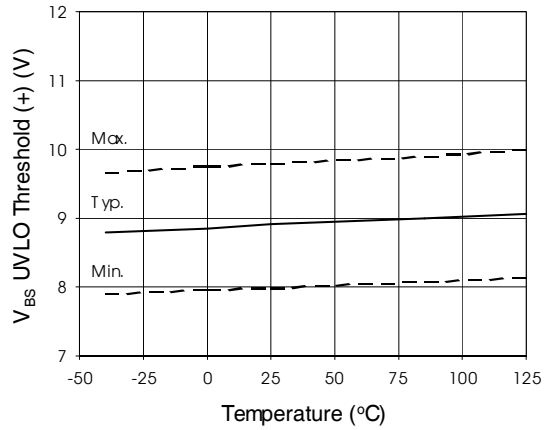


Figure 25.  $V_{BS}$  Undervoltage Threshold (+) vs. Temperature

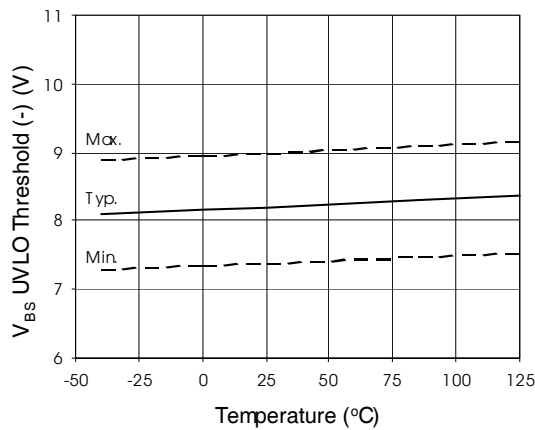


Figure 26.  $V_{BS}$  Undervoltage Threshold (-) vs. Temperature

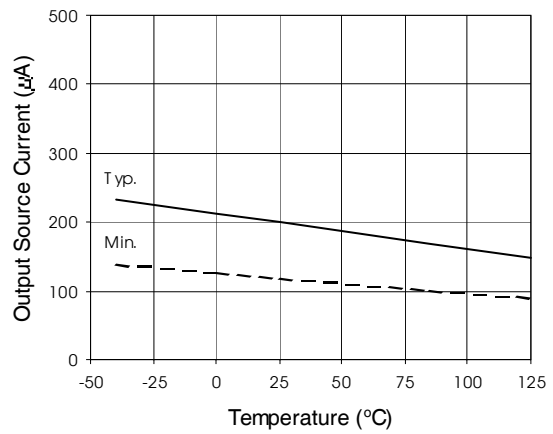


Figure 27A. Output Source Current vs. Temperature

# IR2109(4) (s) & (PbF)

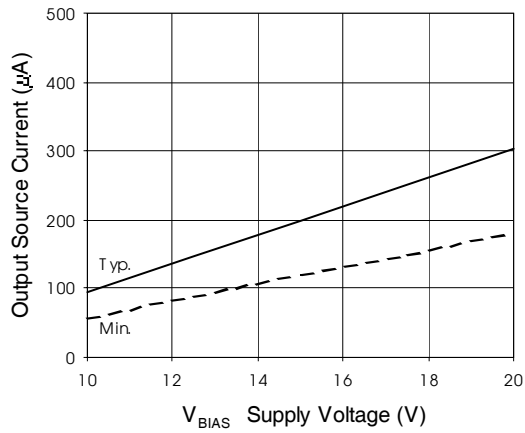


Figure 27B. Output Source Current vs. Supply Voltage

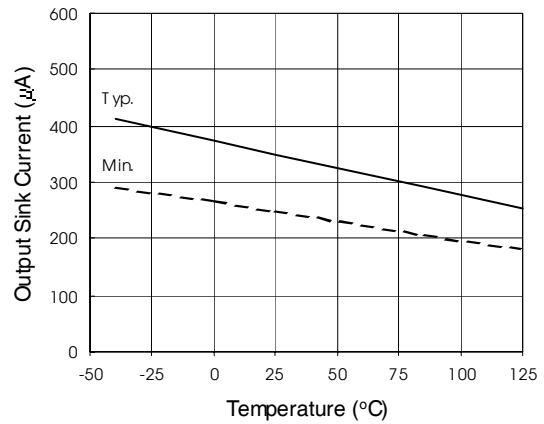


Figure 28A. Output Sink Current vs. Temperature

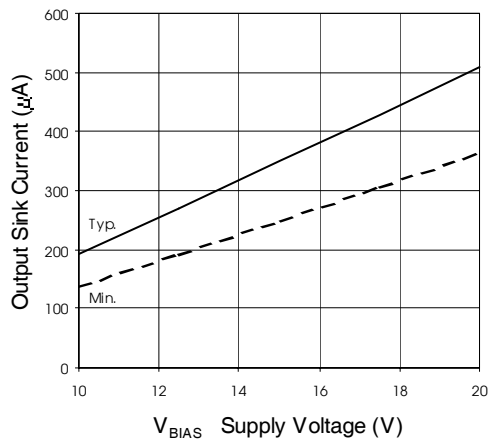


Figure 28B. Output Sink Current vs. Supply Voltage

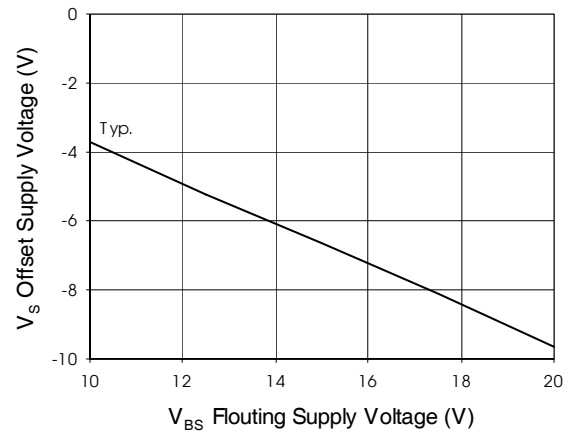


Figure 29. Maximum VS Negative Offset vs. Supply Voltage

# IR2109(4) (s) & (PbF)

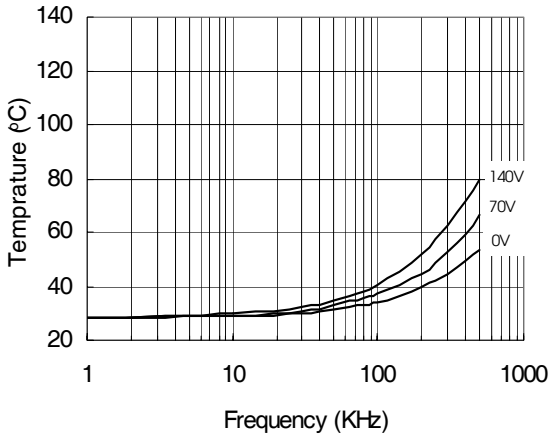


Figure 30. IR2109 vs Frequency (IRFBC20)  
 $R_{gate} = 33\Omega$ ,  $V_{CC} = 15V$

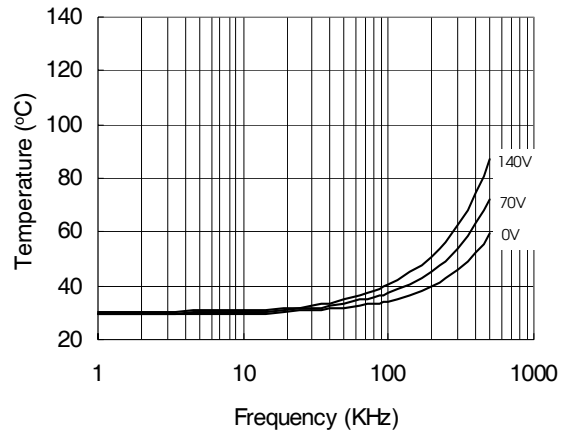


Figure 31. IR2109 vs Frequency (IRFBC30)  
 $R_{gate} = 22\Omega$ ,  $V_{CC} = 15V$

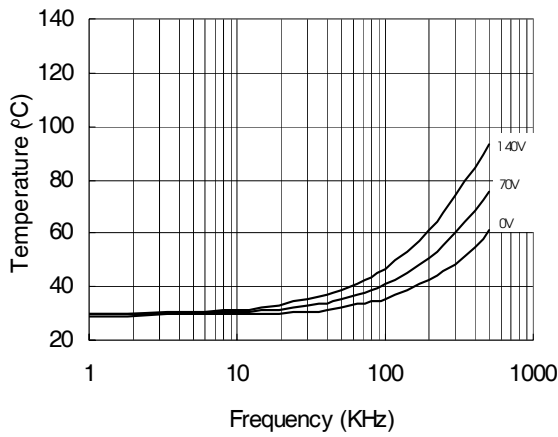


Figure 32. IR2109 vs Frequency (IRFBC40)  
 $R_{gate} = 15\Omega$ ,  $V_{CC} = 15V$

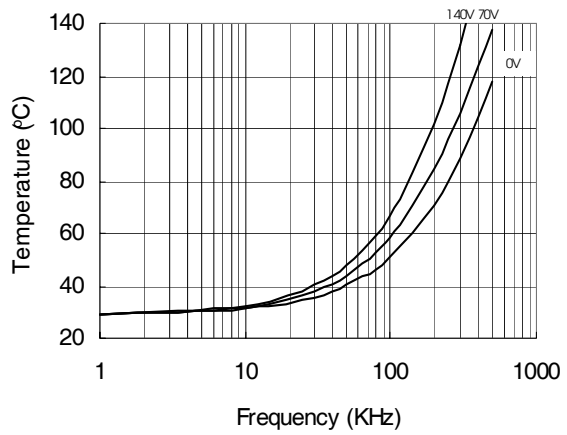


Figure 33. IR2109 vs Frequency (IRFPE50)  
 $R_{gate} = 10\Omega$ ,  $V_{CC} = 15V$

# IR2109(4) (s) & (PbF)

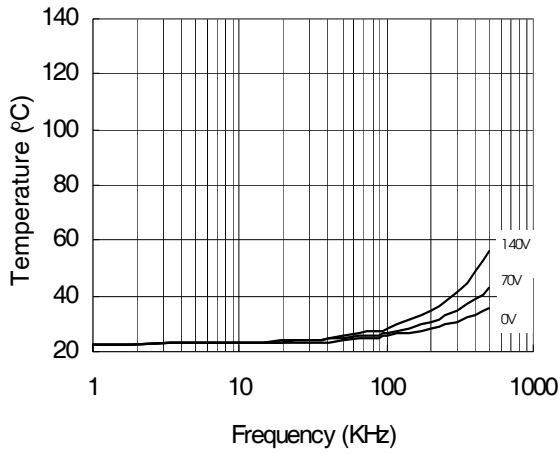


Figure 34. IR21094 vs. Frequency (IRFBC20),  
 $R_{gate}=33\Omega$ ,  $V_{CC}=15V$

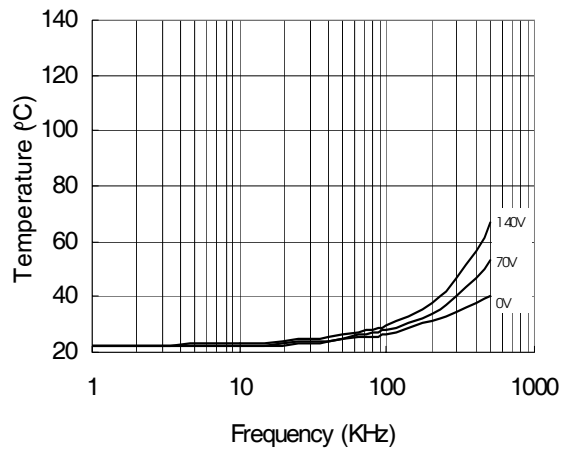


Figure 35. IR21094 vs. Frequency (IRFBC30),  
 $R_{gate}=22\Omega$ ,  $V_{CC}=15V$

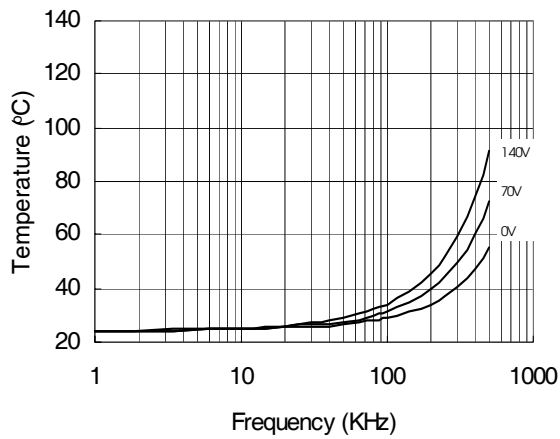


Figure 36. IR21094 vs. Frequency (IRFBC40),  
 $R_{gate}=15\Omega$ ,  $V_{CC}=15V$

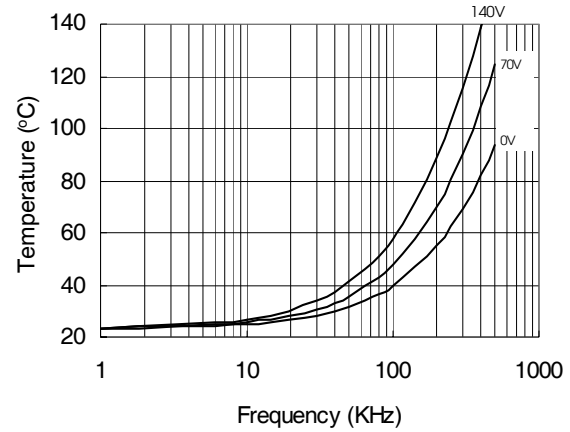


Figure 37. IR21094 vs. Frequency (IRFPE50),  
 $R_{gate}=10\Omega$ ,  $V_{CC}=15V$

# IR2109(4) (S) & (PbF)

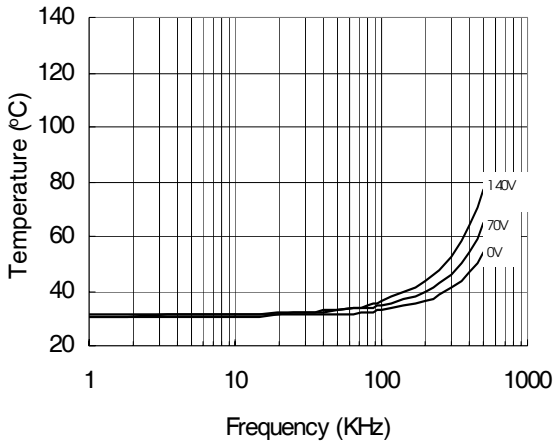


Figure 38. IR2109S vs. Frequency (IRFBC20),  
 $R_{gate}=33\Omega$ ,  $V_{cc}=15V$

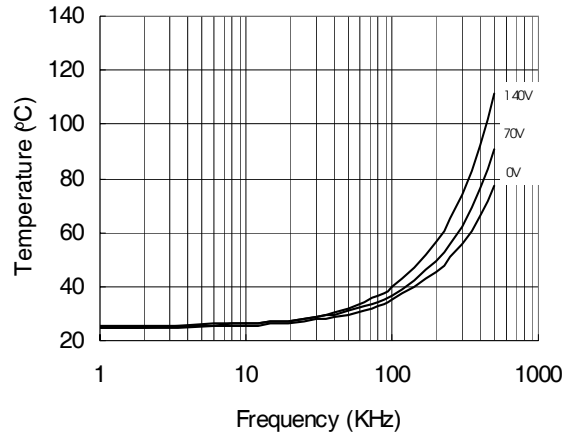


Figure 39. IR2109S vs. Frequency (IRFBC30),  
 $R_{gate}=22\Omega$ ,  $V_{cc}=15V$

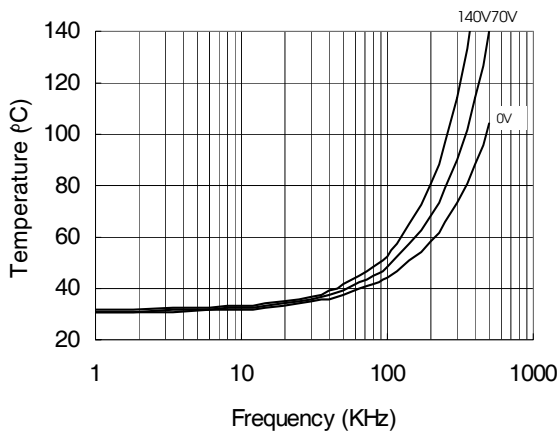


Figure 40. IR2109S vs. Frequency (IRFBC40),  
 $R_{gate}=15\Omega$ ,  $V_{cc}=15V$

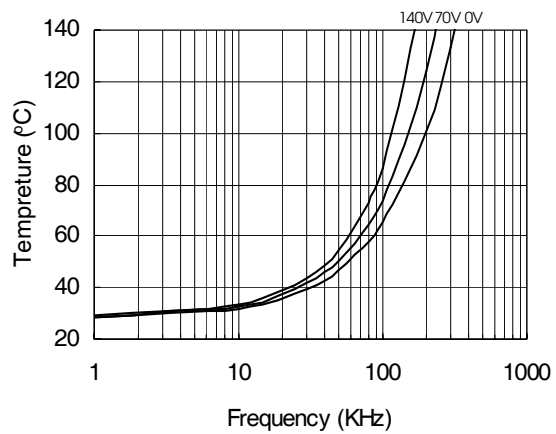


Figure 41. IR2109S vs. Frequency  
(IRFPE50),  $R_{gate}=10\Omega$ ,  $V_{cc}=15V$

# IR2109(4) (s) & (PbF)

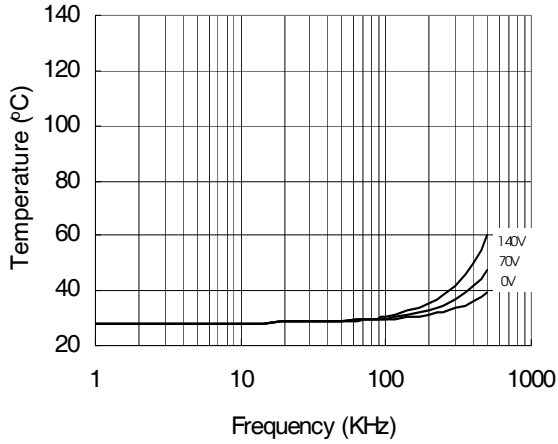


Figure 42. IR21094S vs. Frequency (IRFBC20),  
 $R_{gate}=33\Omega$ ,  $V_{cc}=15V$

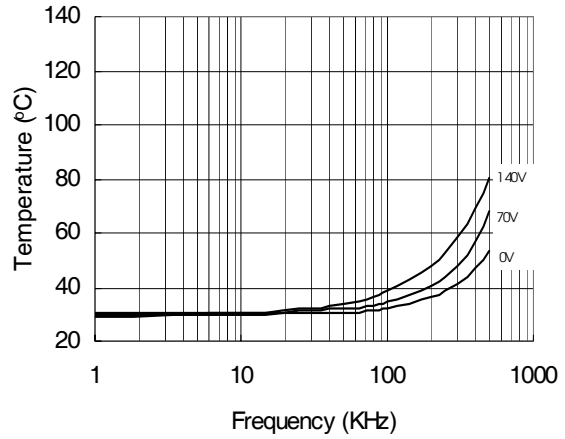


Figure 43. IR21094S vs. Frequency (IRFBC30),  
 $R_{gate}=22\Omega$ ,  $V_{cc}=15V$

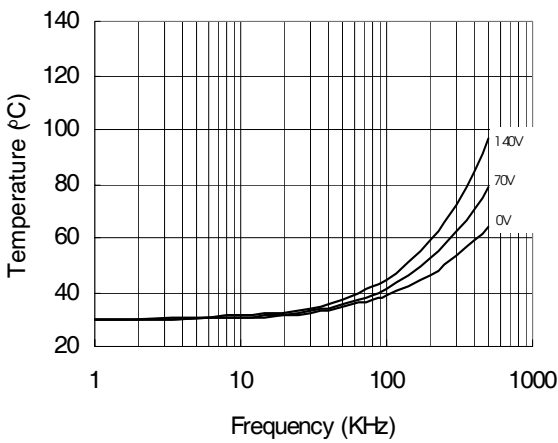


Figure 44. IR21094S vs. Frequency (IRFBC40),  
 $R_{gate}=15\Omega$ ,  $V_{cc}=15V$

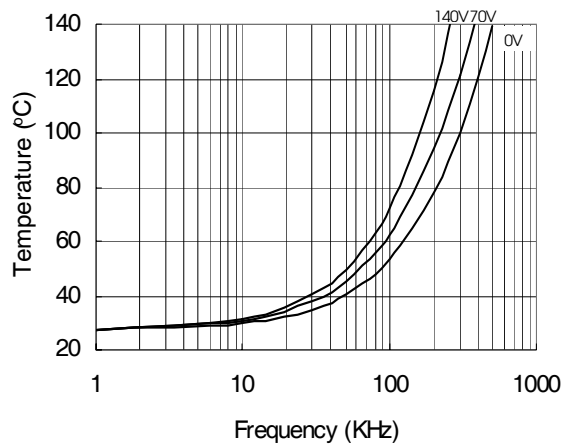
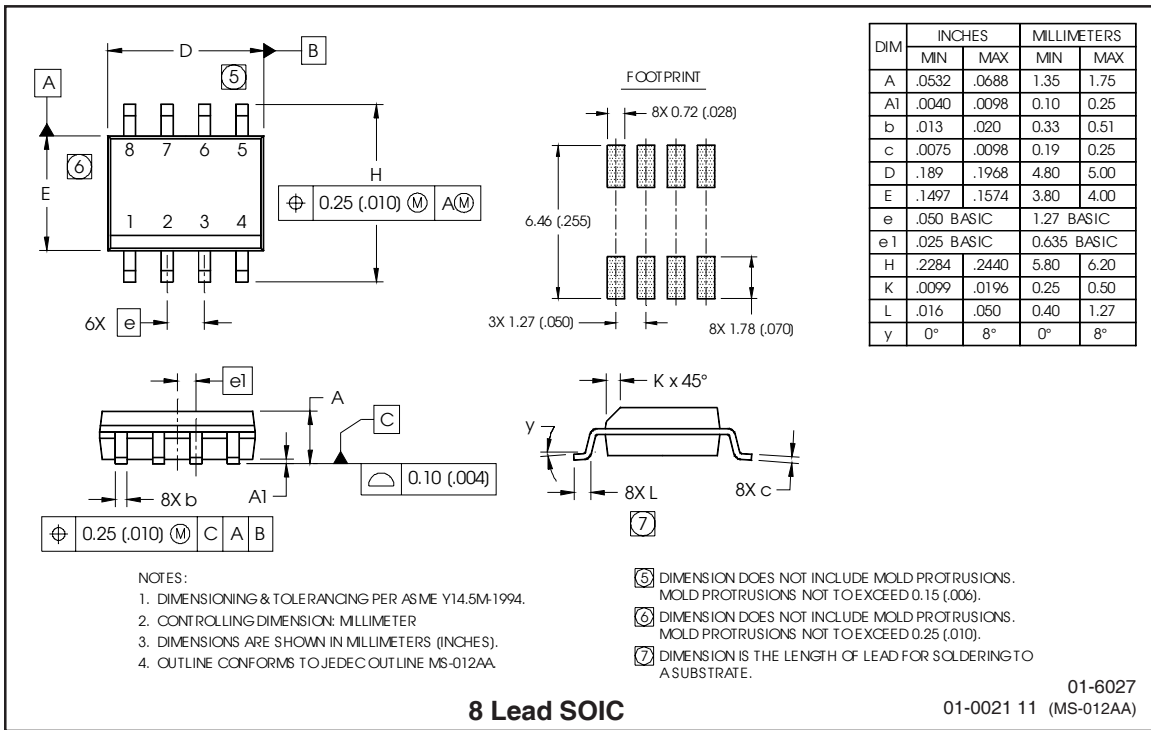
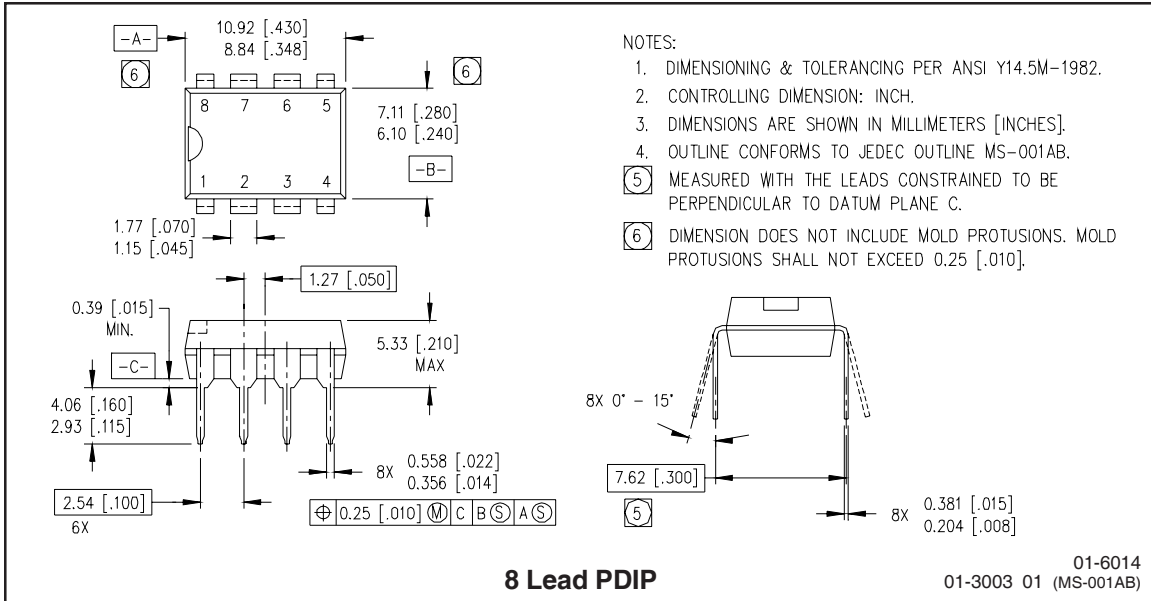


Figure 45. IR21094S vs. Frequency (IRFPE50),  
 $R_{gate}=10\Omega$ ,  $V_{cc}=15V$

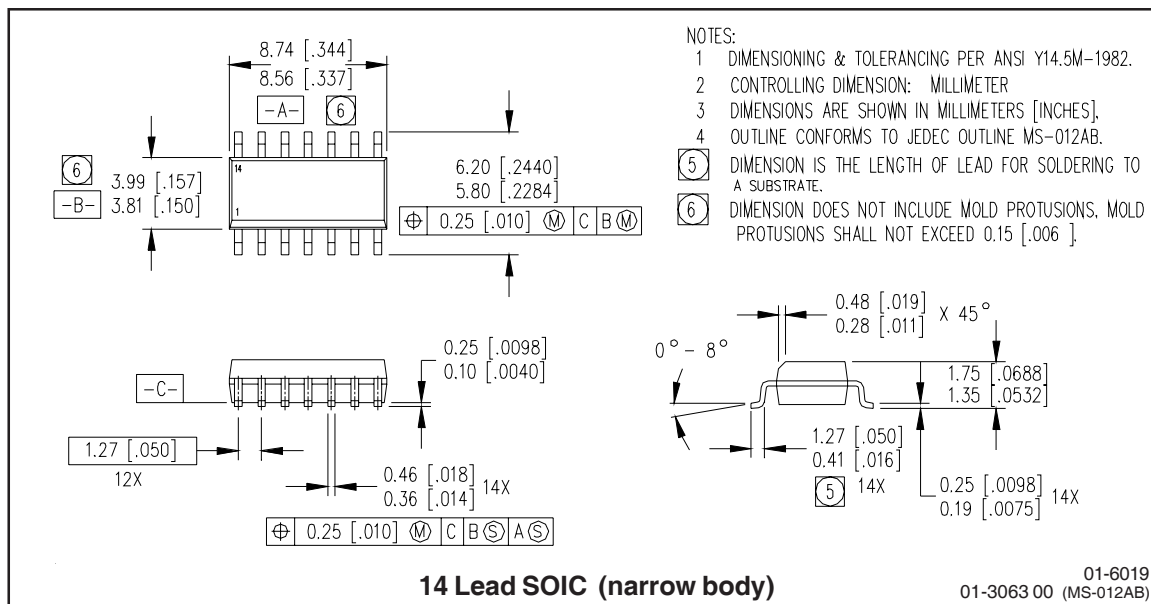
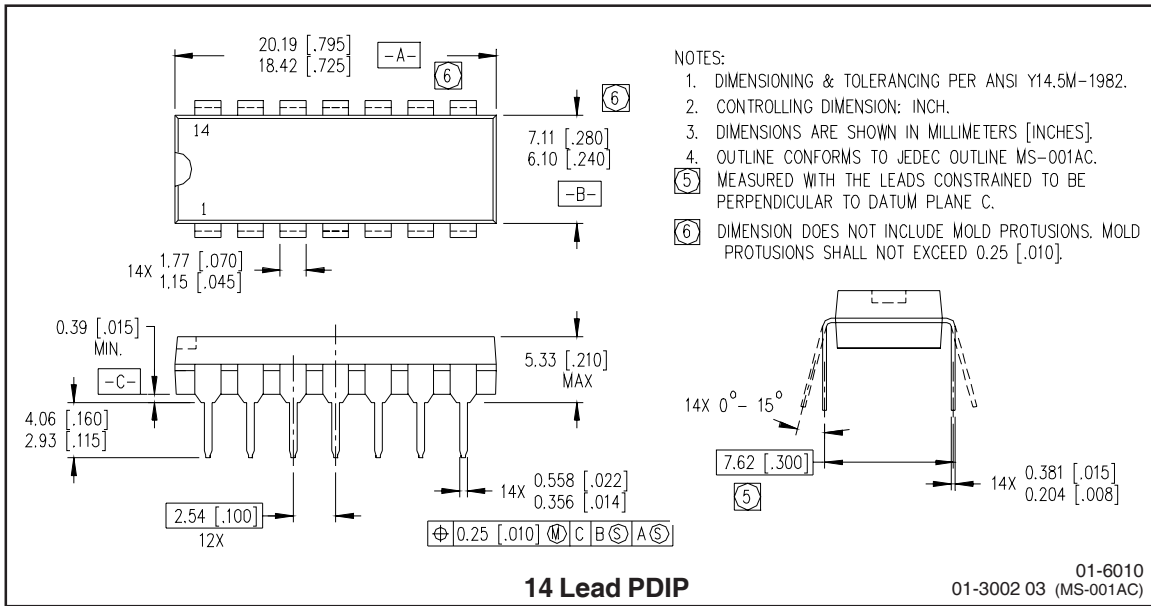
# IR2109(4) (s) & (PbF)

## Case Outlines



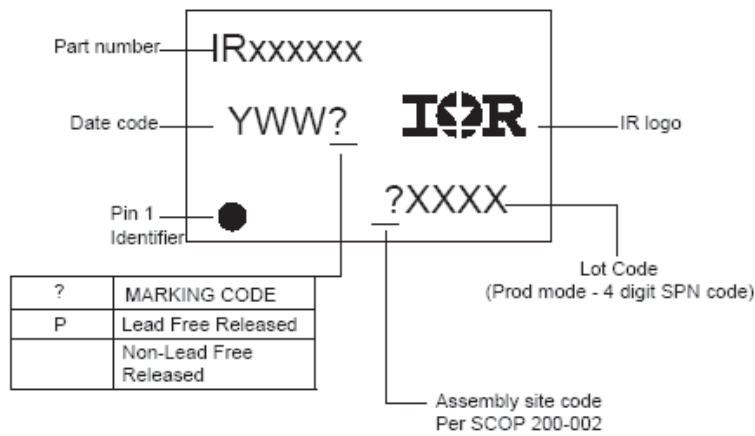
# IR2109(4) (s) & (PbF)

International  
**IR** Rectifier



Data and specifications subject to change without notice. 7/11/2003

## LEADFREE PART MARKING INFORMATION



### Basic Part (Non-Lead Free)

8-Lead PDIP IR2109 order IR2109  
 8-Lead SOIC IR2109S order IR2109S  
 14-Lead PDIP IR21094 order IR21094  
 14-Lead SOIC IR21094S order IR21094S

### Lead-Free Part

8-Lead PDIP IR2109 order IR2109PbF  
 8-Lead SOIC IR2109S order IR2109SPbF  
 14-Lead PDIP IR21094 order IR21094PbF  
 14-Lead SOIC IR21094S order IR21094SPbF

## Looking for pricing, stock, or lifecycle information?

Click below to explore more details on WIN SOURCE:

 [View IR21094STRPBF on WIN SOURCE](#)

 [Infineon Technologies](#) Information

## Optimize Your Supply Chain with WIN SOURCE Solutions

-  Global Sourcing Solution
-  Obsolete Management
-  Cost Control Management
-  Shortage Management
-  Alternative Solution
-  Excess Inventory Management