

Ultra Wideband Audio Transformers

- Highest Density Package Available
- Optimized for Audio Impedance
- Frequency Range: 300Hz - 100KHz
- HiPot: Most parts meet 1KVrms (Pri:Sec)

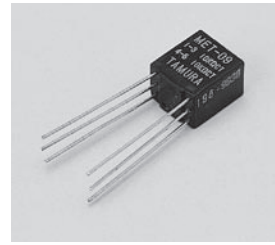

Tamura Part #	Impedance (Pri. Ω)	Impedance (Sec. Ω)	Turns Ratio (Pri:Sec)	UnBalance Current (mA)	Max. Pwr. Level (mW)	Freq. Response (dB)	DCR (Pri. Ω)	DCR (Sec. Ω)	Schematic Fig.
MET-01	200K CT	1K CT	14.1CT:1CT	0.0	10.0	+/-2	5300	120	1
MET-05	25K CT	1K CT	5CT:1CT	0.5	30.0	+/-2	1600	95	1
MET-09	10K CT	10K CT	1CT:1CT	1	40.0	+/-2	1000	1300	1
MET-11	10K CT	2K CT	2.23CT:1CT	1.0	40.0	+/-2	1000	300	1
MET-17	10K CT	500 CT	4.47CT:1CT	1.0	40.0	+/-2	1000	80	1
MET-23	1.6K CT	3.2	22.4CT:1	2.5	65.0	+/-3	186	0.8	3
MET-24	1.5K CT	600	1.58CT:1	3	50.0	+/-2	160	95	3
MET-28	1K	50	4.47:1	3.0	50.0	+/-2	110	8	4
MET-31 ¹	600 CT	600 CT	1CT:1CT	3	50.0	+/-2	70	95	1
MET-32	600	150/150	2:1:1	3	50.0	+/-2	70	95	2
MET-35	600 CT	8	8.66CT:1	4.5	50.0	+/-2	60	1.5	3
MET-39	500	50	3.16:1	3.0	50.0	+/-2	55	8	4
MET-42	150	12	3.54:1	10.0	50.0	+/-2	20	2.5	4
MET-46 ¹	600	600	1:1	3	50.0	+/-2	72	93	4
MET-50	10K	125	8.62:1	0.0	10.0	+/-3	1100	28	4
MET-59	600	150/150	1:1CT	3.0	50.0	+/-2	70	95	2
MET-60	135	135 CT	1:1CT	10	50.0	+/-2	10	10	5
METC-99	Optional Metal Shield								

¹ Meets FCC Parts 68 (Hi-Pot 1.5KV or 1.0KV)

Mechanical Dimensions mm (inches)

All dimensions are typical. Please contact Tamura for tolerances and suggested layout information.

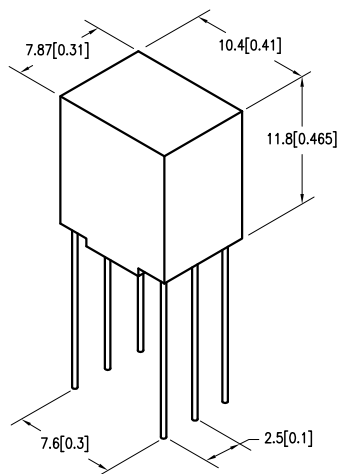

Schematics

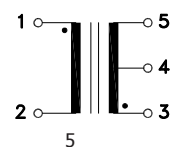
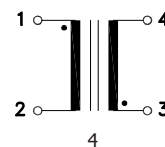
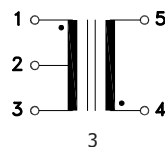
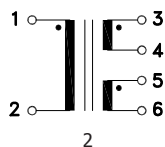
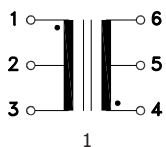

TAMURA CORPORATION

43352 Business Park Drive. | P.O. Box 892230 Temecula, CA 92589-2230 | www.tamuracorp.com

USA
Tel: 800-472-6624
Fax: 951-676-9482

Japan
Tel: 81 (0)3 3978-2111
Fax: 81 (0)3 3923-0230

United Kingdom
Tel: 44 (0) 1380 731 700
Fax: 44 (0) 1380 731 702

Hong Kong
Tel: 852-2389-4321
Fax: 852-2341-9689

Looking for pricing, stock, or lifecycle information?

Click below to explore more details on WIN SOURCE:

 [View MET-09 on WIN SOURCE](#)

 [Tamura Information](#)

Optimize Your Supply Chain with WIN SOURCE Solutions

-  Global Sourcing Solution
-  Obsolete Management
-  Cost Control Management
-  Shortage Management
-  Alternative Solution
-  Excess Inventory Management