



THE DATASHEET OF IPS0151S



FULLY PROTECTED POWER MOSFET SWITCH

Features

- Over temperature shutdown
- Over current shutdown
- Active clamp
- Low current & logic level input
- E.S.D protection

Description

The IPS0151/IPS0151S are fully protected three terminal SMART POWER MOSFETs that feature over-current, over-temperature, ESD protection and drain to source active clamp. These devices combine a HEXFET® POWER MOSFET and a gate driver. They offer full protection and high reliability required in harsh environments. The driver allows short switching times and provides efficient protection by turning OFF the power MOSFET when the temperature exceeds 165°C or when the drain current reaches 35A. The device restarts once the input is cycled. The avalanche capability is significantly enhanced by the active clamp and covers most inductive load demagnetizations.

Product Summary

$R_{ds(on)}$	25mΩ (max)
V_{clamp}	50V
$I_{shutdown}$	35A
T_{on}/T_{off}	1.5μs

Packages

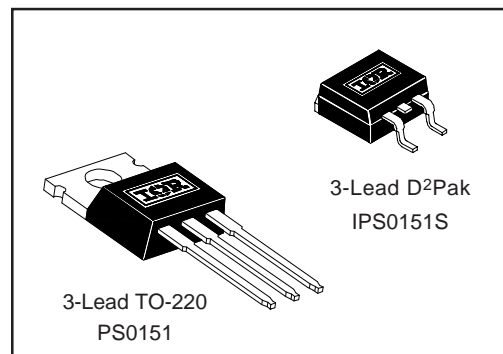

Typical Connection

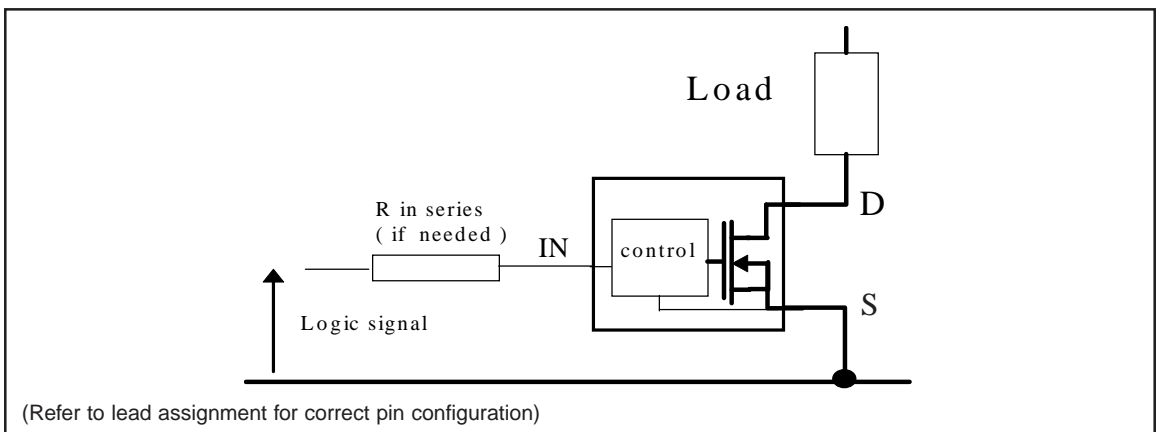

IPS0151(S)

Absolute Maximum Ratings

Absolute maximum ratings indicate sustained limits beyond which damage to the device may occur. All voltage parameters are referenced to SOURCE lead. (T_{Ambient} = 25°C unless otherwise specified). PCB mounting uses the standard footprint with 70 µm copper thickness.

Symbol	Parameter	Min.	Max.	Units	Test Conditions
V _{ds}	Maximum drain to source voltage	—	47	V	
V _{in}	Maximum Input voltage	-0.3	7		
I _{in, max}	Maximum IN current	-10	+10		mA
I _{sd cont.}	Diode max. continuous current ⁽¹⁾ rth=62°C/W IPS0151 rth=5°C/W IPS015135 rth=80°C/W IPS0151S	—	2.8	A	TO220 free air
		—	35		TO220 with Rth=5°C/W
		—	2.2		SMD220 Std footprint
		—	45		
I _{sd pulsed}	Diode max. pulsed current ⁽¹⁾	—	45		
P _d	Maximum power dissipation ⁽¹⁾ (rth=62°C/W) IPS0151 (rth=80°C/W) IPS0151S	—	2	W	
		—	1.56		
ESD1	Electrostatic discharge voltage (Human Body)	—	4	kV	C=100pF, R=1500Ω,
ESD2	Electrostatic discharge voltage (Machine Model)	—	0.5		C=200pF, R=0Ω, L=10µH
T _{stor.}	Max. storage temperature	-55	150	°C	
T _{j max.}	Max. junction temperature	-40	+150		
T _{lead}	Lead temperature (soldering, 10 seconds)	—	300		

Thermal Characteristics

Symbol	Parameter	Min.	Typ.	Max.	Units	Test Conditions
R _{th 1}	Thermal resistance free air	—	55	—	°C/W	TO-220
R _{th 2}	Thermal resistance junction to case	—	2	—		
R _{th 1}	Thermal resistance with standard footprint	—	60	—		D ² PAK (SMD220)
R _{th 2}	Thermal resistance with 1" square footprint	—	35	—		
R _{th 3}	Thermal resistance junction to case	—	2	—		

Recommended Operating Conditions

These values are given for a quick design. For operation outside these conditions, please consult the application notes.

Symbol	Parameter	Min.	Max.	Units
V _{ds (max)}	Continuous drain to source voltage	—	35	V
V _{IH}	High level input voltage	4	6	
V _{IL}	Low level input voltage	0	0.5	
I _{ds} T _{amb} =85°C	Continuous drain current (T _{Ambient} = 85°C, I _N = 5V, rth = 60°C/W, T _j = 125°C) IPS0151 (T _{Ambient} = 85°C, I _N = 5V, rth = 80°C/W, T _j = 125°C) IPS0151S	—	4.3	A
		—	3.8	
R _{in}	Recommended resistor in series with IN pin	0.2	5	kΩ
T _{r-in (max)}	Max recommended rise time for IN signal (see fig. 2)	—	1	µS
F _{r-lsc} ⁽²⁾	Max. frequency in short circuit condition (V _{cc} = 14V)	0	1	kHz

(1) Limited by junction temperature (pulsed current limited also by internal wiring)

(2) Operations at higher switching frequencies is possible. See Application Notes.

Static Electrical Characteristics

(T_j = 25°C unless otherwise specified.)

Symbol	Parameter	Min.	Typ.	Max.	Units	Test Conditions	
R _{ds(on)}	ON state resistance	T _j = 25°C	10	20	25	mΩ	V _{in} = 5V, I _{ds} = 1A
		T _j = 150°C	—	35	45		
I _{dss1} @T _j =25°C	Drain to source leakage current	0	0.5	25	μA	V _{CC} = 14V, T _j = 25°C	
I _{dss2} @T _j =25°C	Drain to source leakage current	0	5	50		V _{CC} = 40V, T _j = 25°C	
V _{clamp 1}	Drain to source clamp voltage 1	47	52	56	V	I _d = 20mA (see Fig.3 & 4)	
V _{clamp 2}	Drain to source clamp voltage 2	50	55	60		I _d =I _{shutdown} (see Fig.3 & 4)	
V _{in clamp}	IN to source clamp voltage	7	8.1	9.5		I _{in} = 1 mA	
V _{in th}	IN threshold voltage	1	1.6	2		I _d = 50mA, V _{ds} = 14V	
I _{in, -on}	ON state IN positive current	25	90	200	μA	V _{in} = 5V	
I _{in, -off}	OFF state IN positive current	50	130	250		V _{in} = 5V over-current triggered	

Switching Electrical Characteristics

V_{CC} = 14V, Resistive Load = 3Ω, R_{input} = 50Ω, 100μs pulse, T_j = 25°C, (unless otherwise specified).

Symbol	Parameter	Min.	Typ.	Max.	Units	Test Conditions
T _{on}	Turn-on delay time	0.05	0.25	0.6	μs	See figure 2
T _r	Rise time	0.2	0.9	1.5		
T _{rf}	Time to (final R _{ds(on)} 1.3%)	—	3.8	—		
T _{off}	Turn-off delay time	0.8	1.5	2		See figure 2
T _f	Fall time	0.4	1.1	2		
Q _{in}	Total gate charge	—	30	—	nC	V _{in} = 5V

Protection Characteristics

Symbol	Parameter	Min.	Typ.	Max.	Units	Test Conditions
T _{sd}	Over temperature threshold	—	165	—	°C	See fig. 1
I _{sd}	Over current threshold	20	35	50	A	See fig. 1
V _{reset}	IN protection reset threshold	1.5	2.3	3	V	
T _{reset}	Time to reset protection	2	10	40	μs	V _{in} = 0V, T _j = 25°C
EOI_OT	Short circuit energy (see application note)	—	400	—	μJ	V _{CC} = 14V

IPS0151(S)

Functional Block Diagram

All values are typical

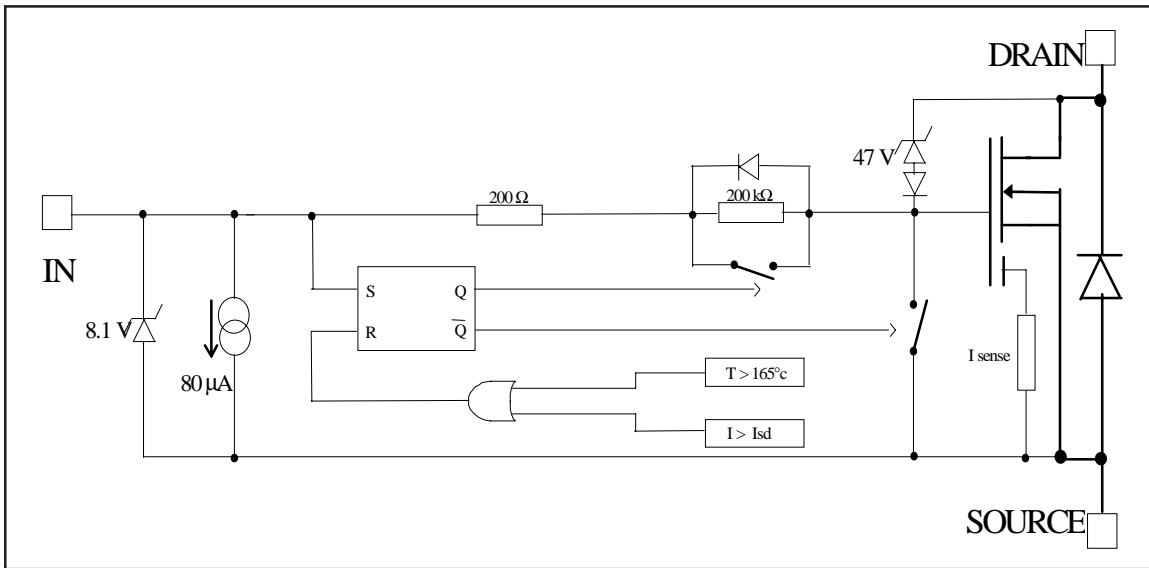

Lead Assignments

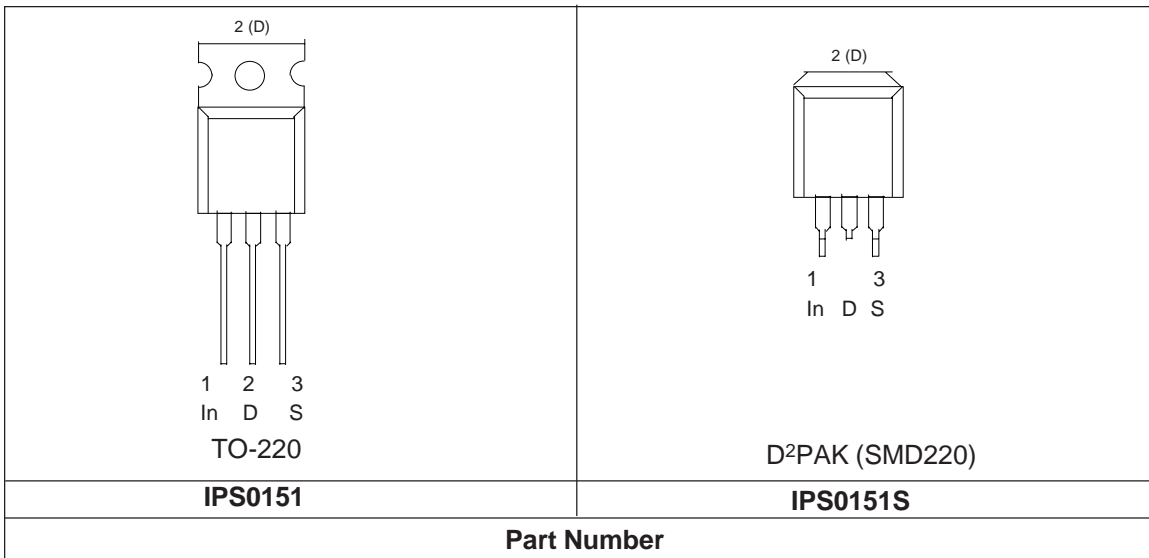

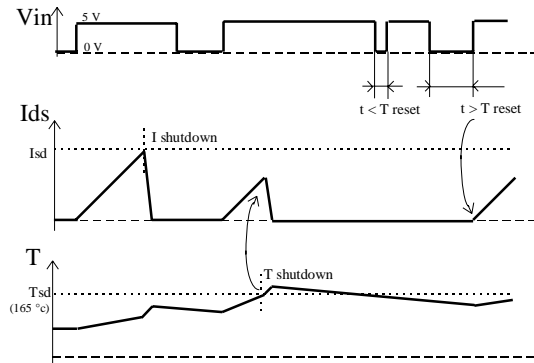

Figure 1 - Timing diagram

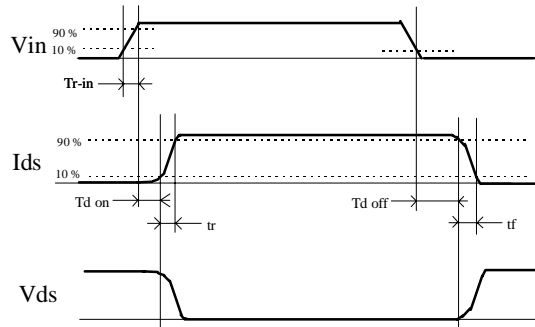

Figure 2 - IN rise time & switching time definitions

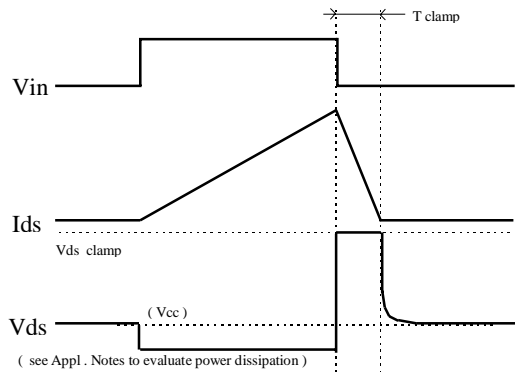

Figure 3 - Active clamp waveforms

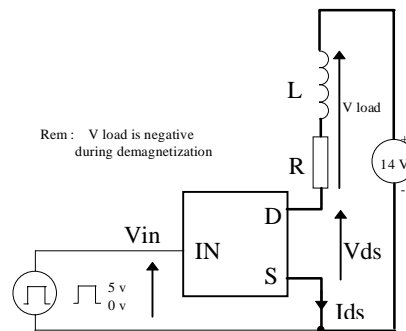

Figure 4 - Active clamp test circuit

All curves are typical values with standard footprints. Operating in the shaded area is not recommended.

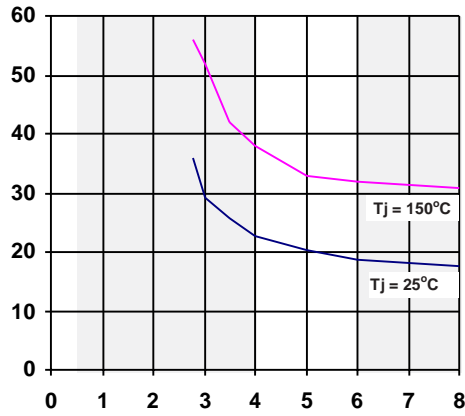

Figure 5 - Rds ON (mΩ) Vs Input Voltage (V)

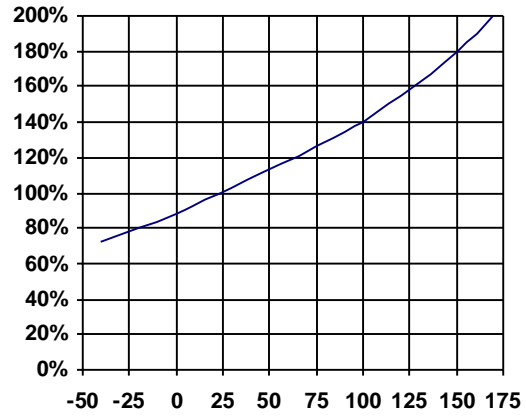

Figure 6 - Normalised Rds ON (%) Vs Tj (°C)

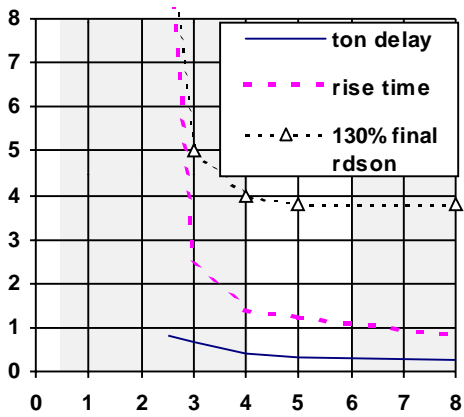

Figure 7 - Turn-ON Delay Time, Rise Time & Time to 130% final Rds(on) (us) Vs Input Voltage (V)

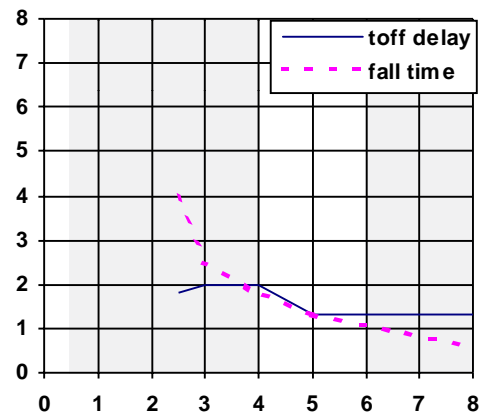

Figure 8 - Turn-OFF Delay Time & Fall Time (us) Vs Input Voltage (V)

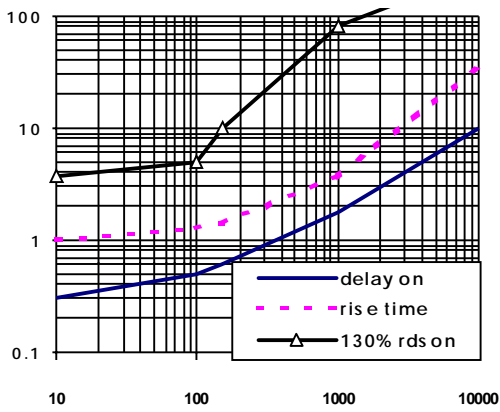

Figure 9 - Turn-ON Delay Time, Rise Time & Time to 130% final Rds(on) (us) Vs IN Resistor (Ω)

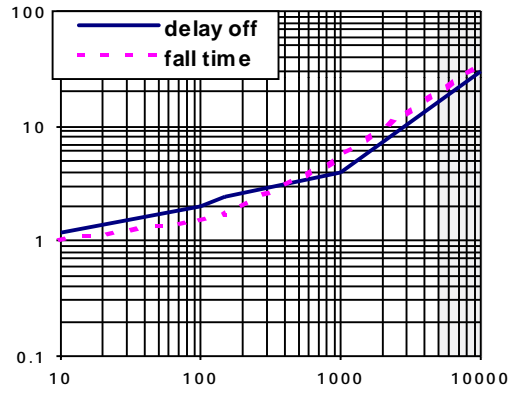

Figure 10 - Turn-OFF Delay Time & Fall Time (us) Vs IN Resistor (Ω)

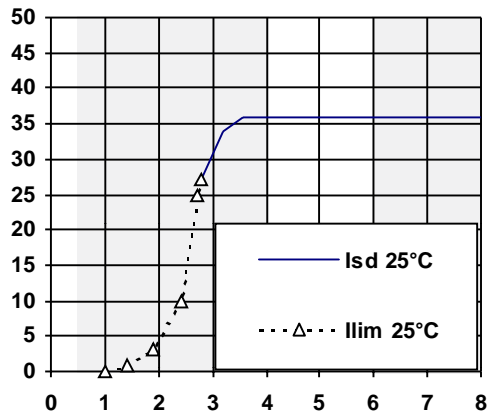

Figure 11 - Current lim. & Ishutdown (A) Vs Vin (V)

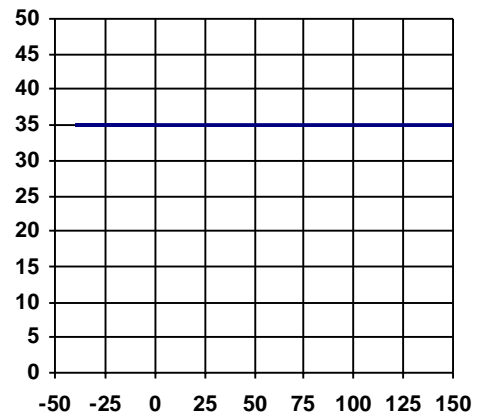

Figure 12 - Ishutdown (A) Vs Temperature (°C)

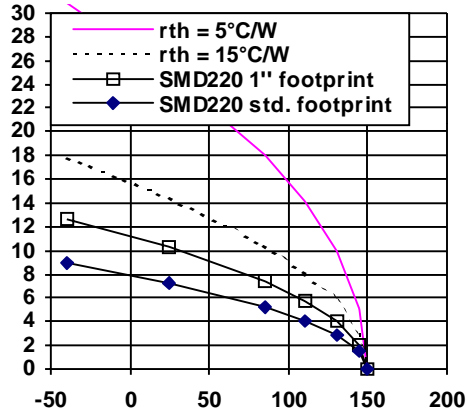

Figure 13 - Max.Cont. Ids (A) Vs Ambient Temperature (°C)

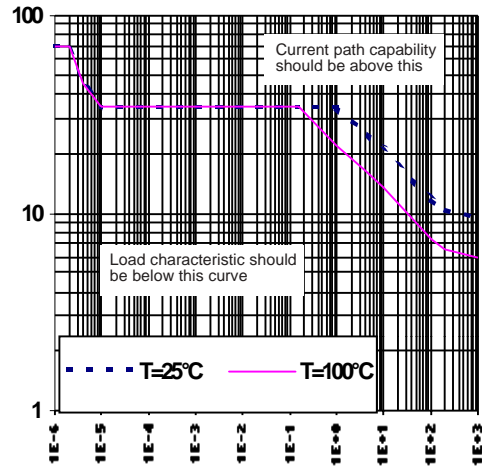

Figure 14 - Max.Cont. Ids (A) Vs Ambient Temperature (°C)

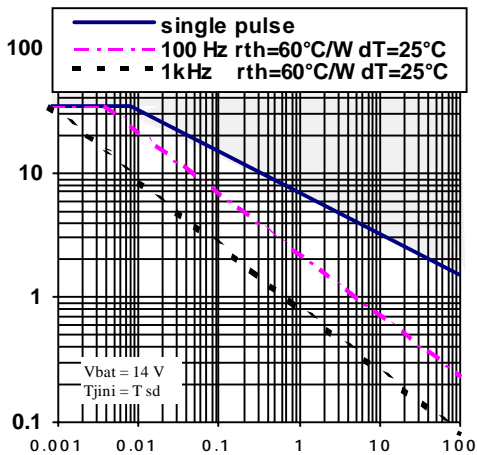

Figure 15 - Iclamp (A) Vs Inductive Load (mH)

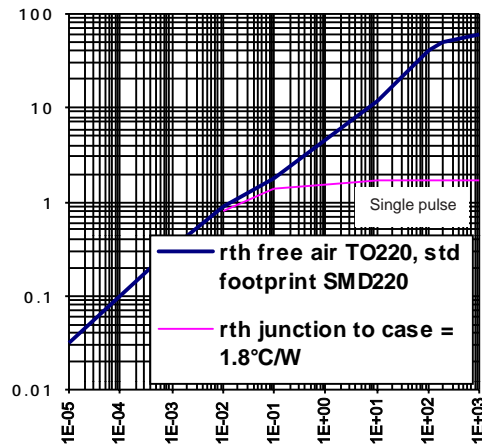

Figure 16 - Transient Thermal Imped. (°C/W) Vs Time (s) - IPS0151/IPS0151S

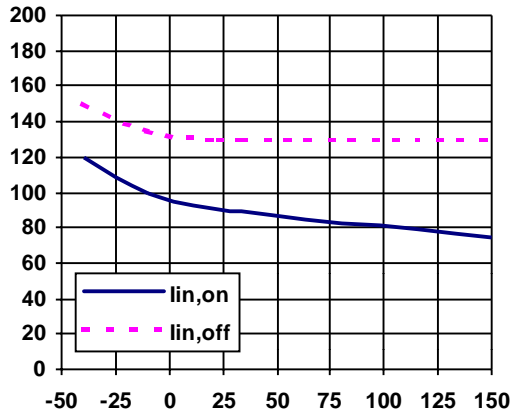

Figure 17 - Input current (μA) Vs Junction ($^{\circ}\text{C}$)

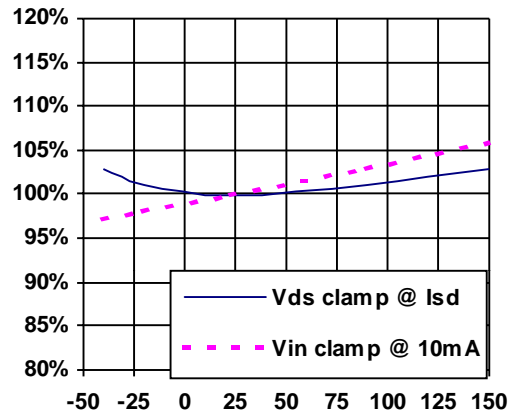

Figure 18 - Vin clamp and V clamp2 (V) Vs Tjunction ($^{\circ}\text{C}$)

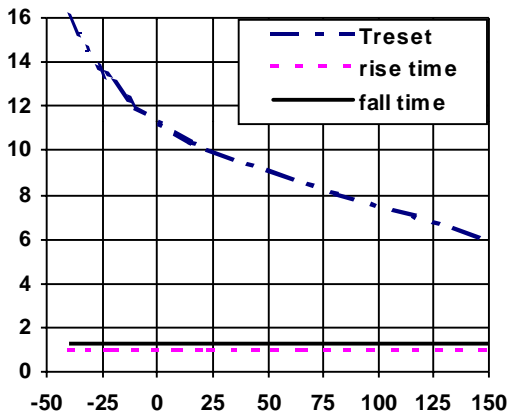
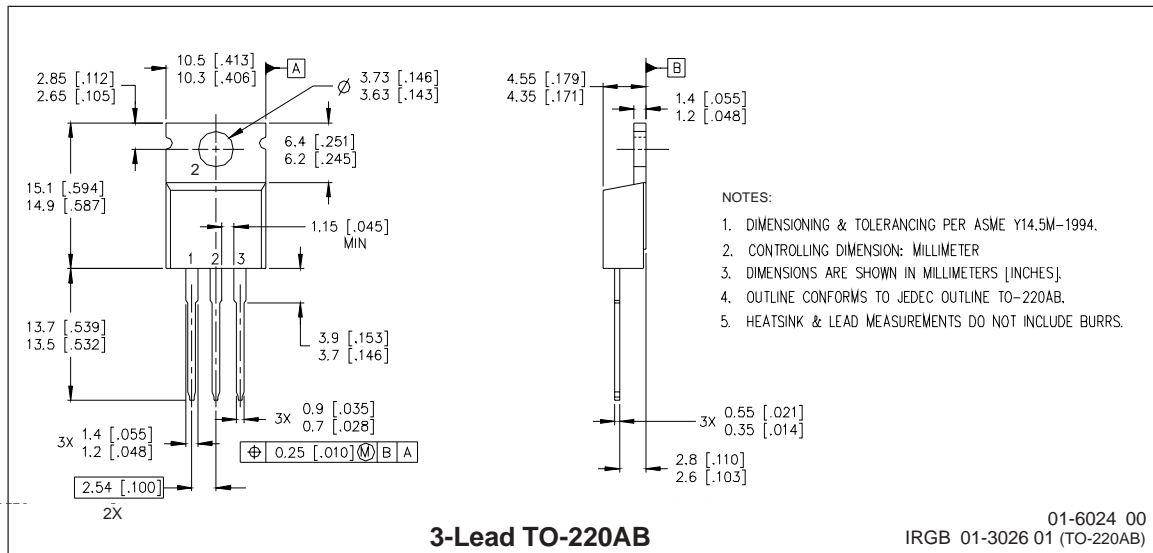
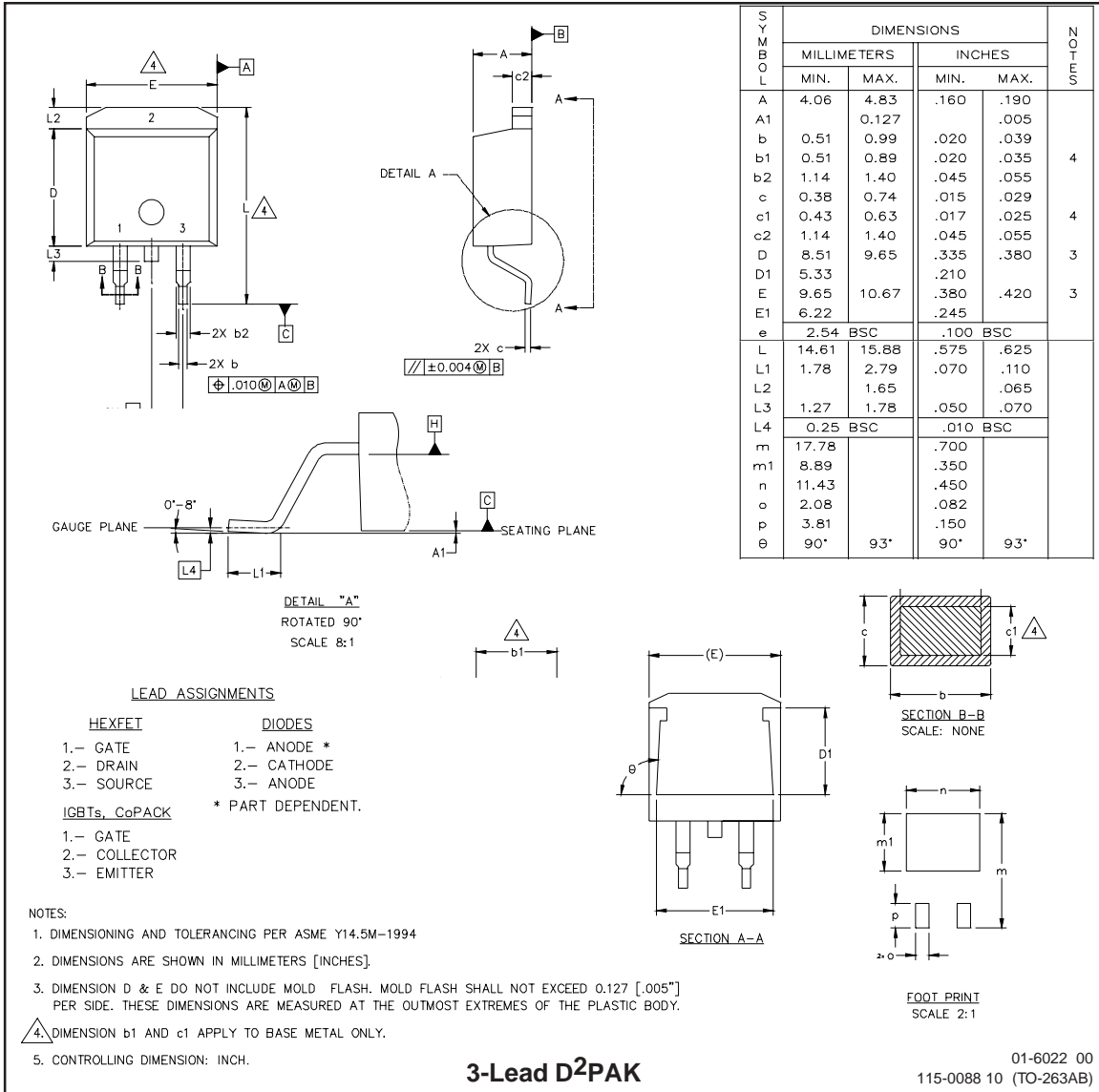

Figure 19 - Turn-on, Turn-off, and Treset (μs) Vs Tjunction ($^{\circ}\text{C}$)

Case Outline



Case Outline



SYMBOL	DIMENSIONS				NOTES
	MILLIMETERS		INCHES		
	MIN.	MAX.	MIN.	MAX.	
A	4.06	4.83	.160	.190	4
A1		0.127		.005	
b	0.51	0.99	.020	.039	
b1	0.51	0.89	.020	.035	
b2	1.14	1.40	.045	.055	4
c	0.38	0.74	.015	.029	
c1	0.43	0.63	.017	.025	
c2	1.14	1.40	.045	.055	
D	8.51	9.65	.335	.380	3
D1	5.33		.210		3
E	9.65	10.67	.380	.420	
E1	6.22		.245		
e	2.54 BSC		.100 BSC		
L	14.61	15.88	.575	.625	
L1	1.78	2.79	.070	.110	
L2		1.65		.065	
L3	1.27	1.78	.050	.070	
L4	0.25 BSC		.010 BSC		
m	17.78		.700		
m1	8.89		.350		
n	11.43		.450		
o	2.08		.082		
p	3.81		.150		
θ	90°	93°	90°	93°	

IPS0151(S)

International
IR Rectifier

Tape & Reel - D²PAK (SMD220)

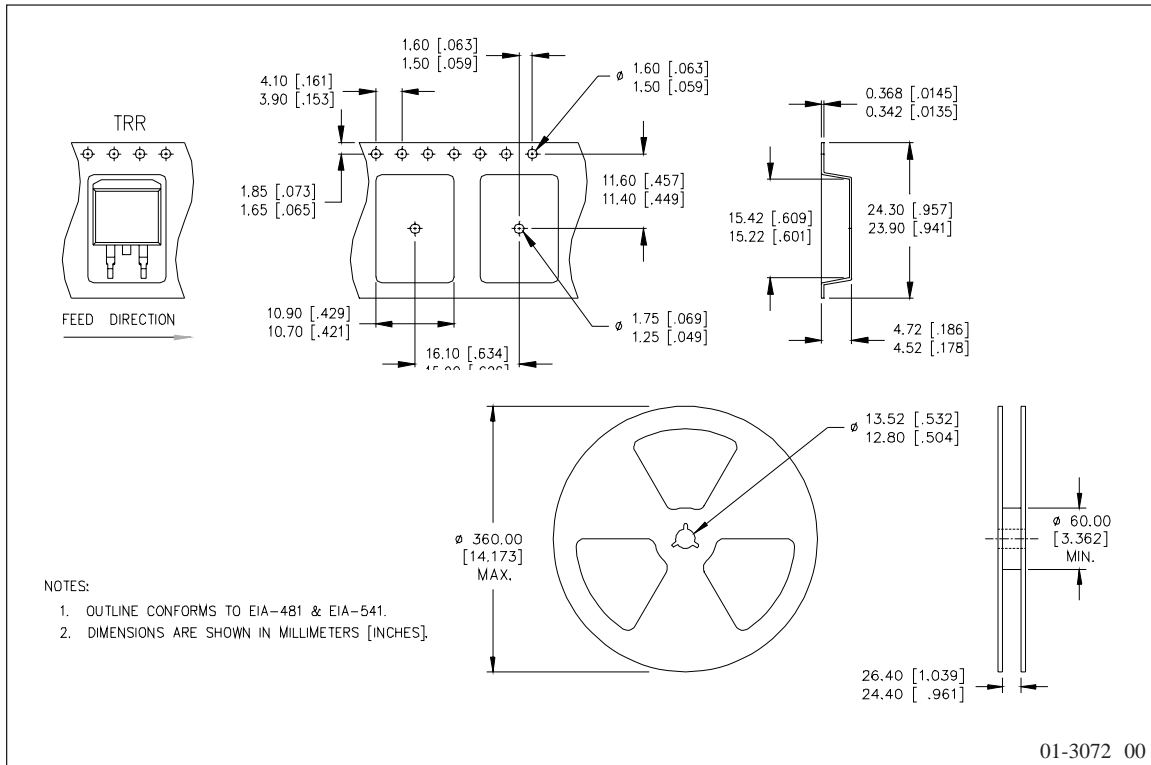



International
IR Rectifier

IR WORLD HEADQUARTERS: 233 Kansas St., El Segundo, California 90245 Tel: (310) 252-7105
Data and specifications subject to change without notice. 11/13/2001

Note: For the most current drawings please refer to the IR website at:
<http://www.irf.com/package/>

Looking for pricing, stock, or lifecycle information?

Click below to explore more details on WIN SOURCE:

-  [View IPS0151S on WIN SOURCE](#)
-  [Infineon Technologies](#) Information

Optimize Your Supply Chain with WIN SOURCE Solutions

-  Global Sourcing Solution
-  Obsolete Management
-  Cost Control Management
-  Shortage Management
-  Alternative Solution
-  Excess Inventory Management